

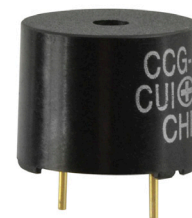

**MODEL:** CCG-1206 | **DESCRIPTION:** MAGNETIC BUZZER TRANSDUCER**FEATURES**

- through hole
- 5 V rated
- externally driven

**SPECIFICATIONS**

parameter	conditions/description	min	typ	max	units
rated voltage			5.0		Vo-p
operating voltage		4.0		8.0	Vo-p
current consumption	at rated voltage, 2,400 Hz square wave, 1/2 duty			50	mA
rated frequency			2,400		Hz
sound pressure level	at 10 cm (A-weight), rated voltage, 2,400 Hz square wave, 1/2 duty	85	91		dB(A)
coil resistance		36.0	42.0	48.0	$\Omega$
dimensions	$\varnothing 12.0 \times 9.5$				mm
weight			1.6		g
material	PBT+15% GF				
terminal	pin type (Sn plating)				
operating temperature		-35		75	$^{\circ}\text{C}$
storage temperature		-40		85	$^{\circ}\text{C}$
washable	yes				
RoHS	yes				

Notes: 1. All specifications measured at 5~35 $^{\circ}\text{C}$ , humidity at 45~85%, under 86~106 kPa pressure, unless otherwise noted.

**SOLDERABILITY**

parameter	conditions/description	min	typ	max	units
hand soldering	for maximum 2 seconds	330		380	$^{\circ}\text{C}$
wave soldering	see wave solder profile	255	260	265	$^{\circ}\text{C}$

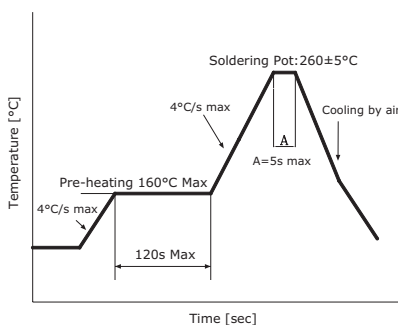

## MECHANICAL DRAWING

units: mm  
tolerance:  $\pm 0.5$  mm

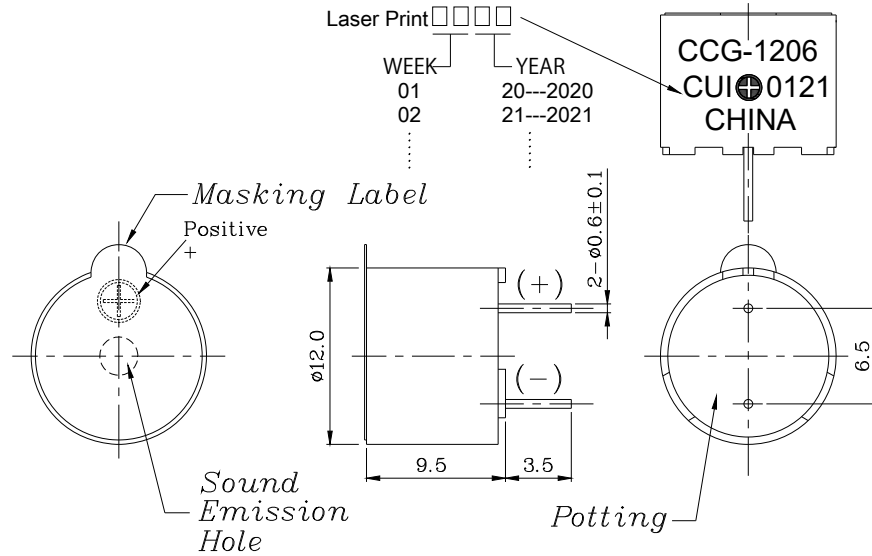

## FREQUENCY RESPONSE CURVE

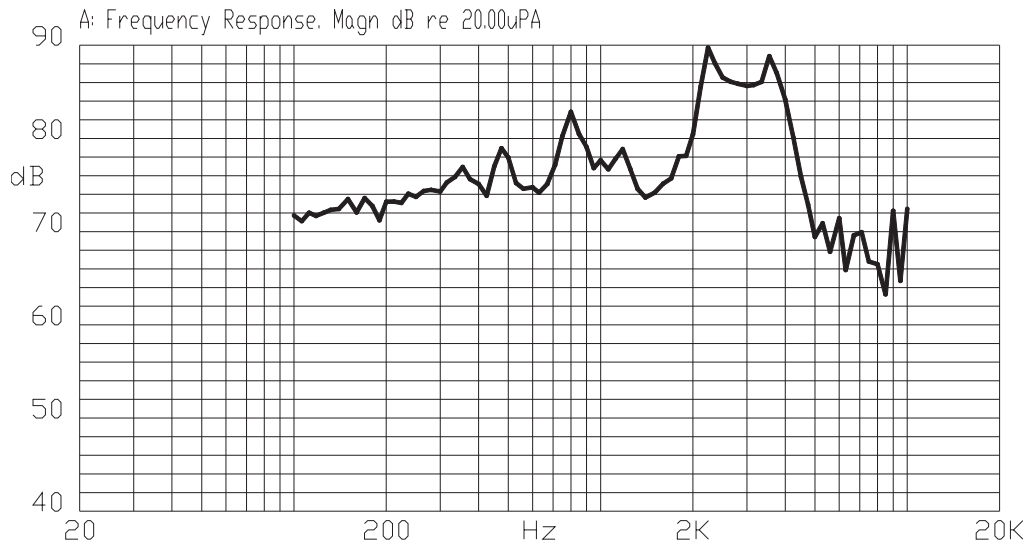

## APPLICATION CIRCUIT

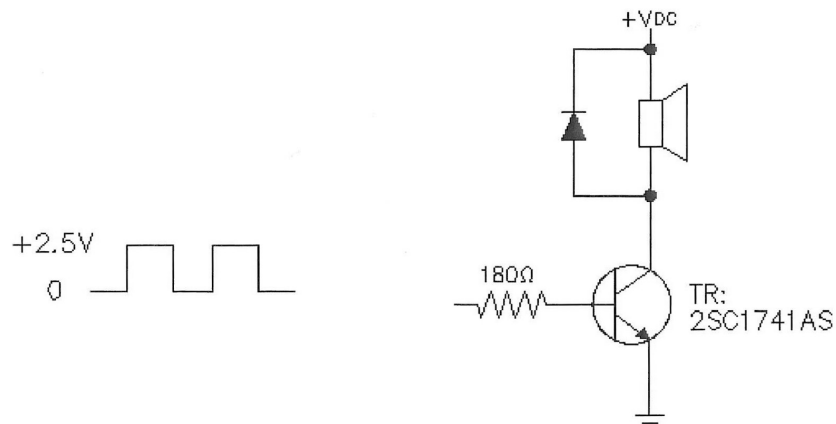

## PACKAGING

units: mm

Tray Size: 184 x 180 x 23 mm  
 Carton Box Size: 445 x 405 x 320 mm  
 Tray QTY: 100 pcs per box  
 Carton Box QTY: 6,000 pcs per carton

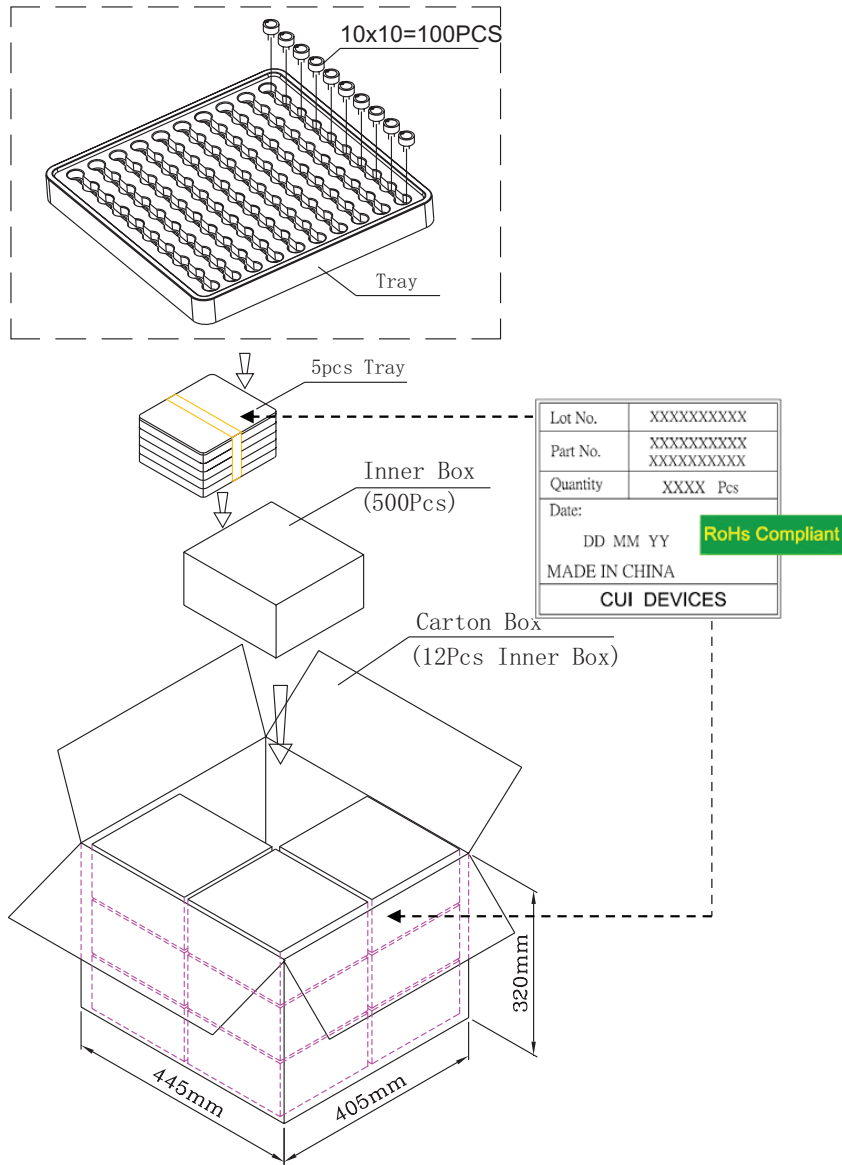

## REVISION HISTORY

---

rev.	description	date
1.0	initial release	03/19/2007
1.01	brand update	02/04/2020
1.02	modified housing	09/15/2021

The revision history provided is for informational purposes only and is believed to be accurate.

---

# CUI DEVICES

CUI Devices offers a one (1) year limited warranty. Complete warranty information is listed on our website.

CUI Devices reserves the right to make changes to the product at any time without notice. Information provided by CUI Devices is believed to be accurate and reliable. However, no responsibility is assumed by CUI Devices for its use, nor for any infringements of patents or other rights of third parties which may result from its use.

CUI Devices products are not authorized or warranted for use as critical components in equipment that requires an extremely high level of reliability. A critical component is any component of a life support device or system whose failure to perform can be reasonably expected to cause the failure of the life support device or system, or to affect its safety or effectiveness.