

CBR-SMD RF COG, Ceramic, 8.6 pF, +/-0.1 pF, 50 VDC, COG, SMD, Fixed, RF, Ultra High Q, Low ESR, Class I, 0201

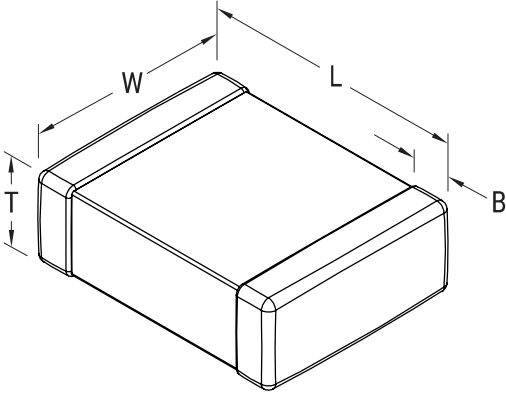

Dimensions	
Chip Size	0201
L	0.6mm +/-0.03mm
W	0.3mm +/-0.03mm
T	0.3mm +/-0.03mm
B	0.15mm +/-0.05mm

Packaging Specifications	
Packaging:	T&R, 180mm, Plastic Tape
Packaging Quantity:	15000

General Information	
Series:	CBR-SMD RF COG
Style:	SMD Chip
Description:	SMD, Fixed, RF, Ultra High Q, Low ESR, Class I
Features:	Ultra High Q, Low ESR, Class I
RoHS:	Yes
Termination:	Tin
Marking:	No
AEC-Q200:	No
Notes:	Solder Reflow Only.
Shelf Life:	78 Weeks
MSL:	1

Specifications	
Capacitance:	8.6 pF
Capacitance Tolerance:	+/-0.1 pF
Voltage DC:	50 VDC
Dielectric Withstanding Voltage:	125 VDC
Temperature Range:	-55/+125°C
Temperature Coefficient:	COG
Dissipation Factor:	0.175%
Aging Rate:	0% Loss/Decade Hour
Insulation Resistance:	10 GOhms
Quality Factor:	572