

specifications

MINI-COM™ Executive and Classic Series Bezels shall be single and double gang bezels with two or four mounting screws. The Executive Series Bezel shall have a curved appearance with labels and label covers. The Classic Series Bezel shall have a flush appearance and the heads of the screw shall match the color of the bezel. Bezels shall accept **MINI-COM** inserts, providing front access to all **MINI-COM** modules.



MINI-COM™ Bezels and Inserts

technical information

Faceplate dimensions	Single Gang H x W x L=0.58 x 2.75 x 4.50 in.(14.7 x 69.8 x 114.3mm) Double Gang H x W x L=0.58 x 4.50 x 4.50 in.(14.7 x 114.3 x 114.3mm)
Mounting options	Slotted screw holes spaced for single and double gang openings; works with Panduit wall board adapters (MWBA1 & MWBA-2G)
Number of ports	Varies with type of module used. Maximum for single gang is 6, maximum for double gang is 12
Color options	6 colors available (see side bar)
Style options	Classic Series or Executive Series
Packaging	Supplied with two labels and two label covers (Executive Only), two or four (depending on single or double gang) 1" long #6-32 slotted/Phillips pan head screws with non-threaded lead point and packaged 1 per bag, 10 per box
Inserts	Available for a variety of communications formats (see sidebar)

key features and ...benefits

Modularity	Accepts all MINI-COM copper and fiber modules; inserts work with either Classic or Executive Series bezels
Front access	Modules are easily accessible
Bend Radius Control	Protects cable and complies with standards (optimized with sloped inserts)
Economical	Lower installed cost (Classic Series)
Sleek Design	Aesthetically pleasing look and feel
Labels and Label Covers	Follows TIA/EIA-606 labeling standards (Executive Series)
Screw Covers	Hide screw heads and give faceplate a clean look (Executive Series)
Slotted screw holes	Allows minor adjustment to faceplate alignment and eases installation (Executive Series)

applications

Bezel style faceplates, with their flexibility in using different inserts, work with any standard size single or double gang junction box. The faceplates also work with wallboard adapters and raceway mounting brackets. The inserts allow for front access to the modules, making it easier for an installer to make changes to the modules without having to unscrew the faceplate. Being able to remove and replace the inserts and configure inserts differently gives the end user greater flexibility. Utilizing the blank inserts allows for future expansion of modules. The sloped shuttered insert is an excellent solution for fiber modules because it provides bend radius control and dust protection. Labeling the bezels is easy with various labeling options.

Visit our website at: www.panduit.com

Classic Series Bezels

Single Gang	CB**
Double Gang	CB**-2G

Executive Series Bezels

Single Gang	CBE**
Double Gang	CBE**-2G

1/2 Size Inserts (1/2 of single gang)

Sloped Insert	CHS2**-X
Sloped Shuttered	CHS2S**-X
Flat Insert	CHF2**-X
Sloped Recessed	CHSR2**-X
Blank Insert	CHB2**-X

1/3 Size Inserts (1/3 of single gang)

Flat Insert	CHF2M**-X
Blank Insert	CHB2M**-X

2/3 Size Inserts (2/3 of single gang*)

Sloped Recessed	CHS2R2**-X
-----------------	------------

* Uses 2/3 of a single gang bezel. Can be used with one (1) 1/3 size insert.

** Color Substitution:

IW	Off White
EI	Electrical Ivory
IG	International Gray
WH	White
BL	Black
RD	Red

installer tip

Using the sloped insert provides better radius control for both fiber and copper cable

MINI-COM™ Bezels and Inserts

Classic Series Bezels

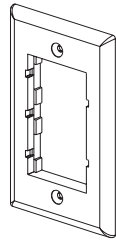
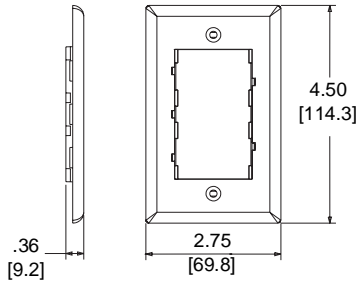

Executive Series Bezels

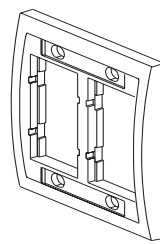
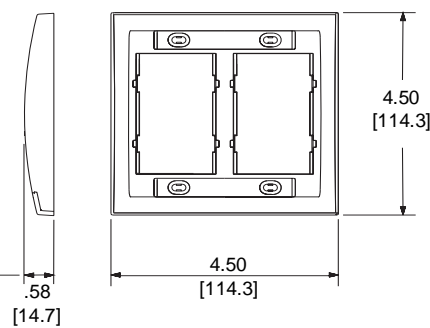
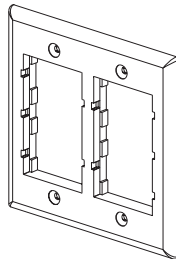
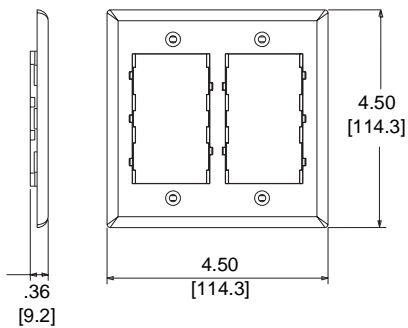
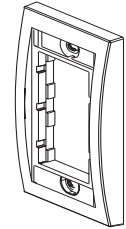
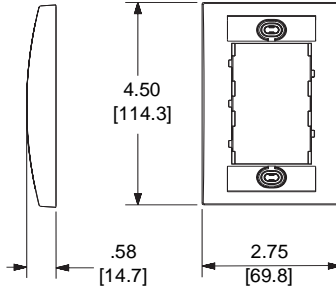

Dimensions are in inches [Dimensions in brackets are in millimeters]

Inserts

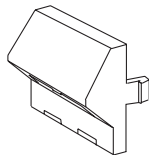

1/2 Sloped Insert

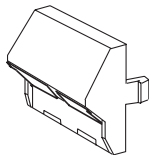

1/2 Sloped Shuttered

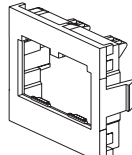

1/2 Flat Insert

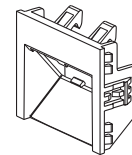

1/2 Sloped Recessed

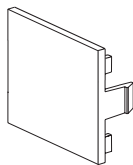

1/2 Blank Insert

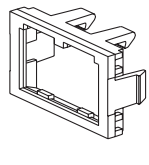

1/3 Flat Insert

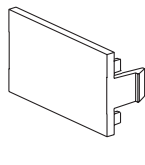

1/3 Blank Insert

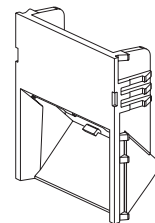

2/3 Sloped Recessed

The information contained in this literature is based on our experience to date and is believed to be reliable. It is intended as a guide for use by persons having technical skill at their own discretion and risk. We do not guarantee favorable results or assume any liability in connection with its use.

Dimensions contained herein are for reference purposes only. For specific dimensional requirements consult the factory. This publication is not to be taken as a license to operate under, or a recommendation to infringe any existing patents. This supersedes and voids all previous literature, etc.



NETWORK SYSTEMS GROUP

Panduit Corp. Phone: 888-506-5400, Ext. 6914
 Fax: 708-460-2897
 Email: info@panduit.com
 Website: http://www.panduit.com

Panduit Canada Phone: 800-387-9689
 FAX: 905-475-6998

WORLDWIDE SUBSIDIARIES AND SALES OFFICES

**For Pricing and Further Information –
 Contact your local authorized
 PANDUIT PAN-NET™ Distributor or Sales Office**

©Panduit Corp. 1999
 ALL RIGHTS RESERVED

SA117N241-OP
 Printed in U.S.A.