

Accessories Index

- **Cable**
 - T-Cable21-1
 - Y-Cable21-3

- **Adaptor**
 - T-Adaptor21-4
 - Y-Adaptor21-6
 - I-Adaptor21-7

- **Cap**
 - Dust Cap21-9
 - Waterproof Cap21-11
 - Dummy21-18

- **Multi-port**
 - Multi-port21-19

- **Box**
 - Box21-21

- **Tool**
 - Wrench21-22
 - Unlock Tool21-22

- **Joint**
 - Joint21-23

- **Patch Cable (Double-ended)**
 - Patch Cable (Double-ended).....21-24

Accessories - Cable

➤ T-Cable > Circular > Standard Size: 5/8"-27 UNS

■ Customized – Upon Request

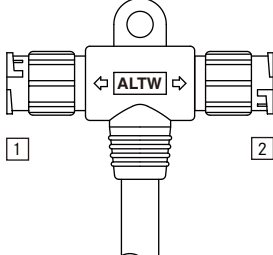

5 For connector 1
6 For connector 2

Choose Connector / Contacts Gender:
M: Male + Male
F: Female + Female
H: Male + Female
B: Female + Male

* Choose the cable length: 01-99 m /
PVC UL2464 Cable

| Current Rating | Contacts 2 | Mating Style | Connector 1 (Male Connector / Male Contacts) | Connector 1 (Female Connector / Female Contacts) | More options |
|----------------|----------------------|----------------------|---|---|------------------|
| | | | Connector 2 (Male Connector / Male Contacts) | Connector 2 (Female Connector / Female Contacts) | |
| 10A | 02,03,04 | Screw Thread | BA-2200-MM0-TSA* | BA-2200-FF0-TSA* | BA-2200-560-TSA* |
| | | 2 point lock bayonet | BA-2200-MM0-TLA* | BA-2200-FF0-TLA* | BA-2200-560-TLA* |
| 5A | 02,03,04,05,06,07,08 | Screw Thread | BA-2200-MM0-TSA* | BA-2200-FF0-TSA* | BA-2200-560-TSA* |
| | | 2 point lock bayonet | BA-2200-MM0-TLA* | BA-2200-FF0-TLA* | BA-2200-560-TLA* |
| 2A | 10,12 | Screw Thread | BA-2200-MM0-TSA* | BA-2200-FF0-TSA* | BA-2200-560-TSA* |
| | | 2 point lock bayonet | BA-2200-MM0-TLA* | BA-2200-FF0-TLA* | BA-2200-560-TLA* |

➤ T-Cable > Circular > Other Size > Mix Size (10A+5A)

■ Customized – Upon Request

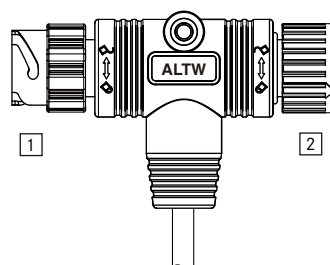

* Choose the cable length: 01-99 m /
PVC UL2464 Cable

| Current Rating | Contacts | Mating Style | Connector 1 (Male Connector / Male Contacts) | Connector 1 (Female Connector / Female Contacts) | Connector 1 (Male Connector / Male Contacts) |
|----------------|----------|--------------|---|---|---|
| | | | Connector 2 (Male Connector / Male Contacts) | Connector 2 (Female Connector / Female Contacts) | Connector 2 (Female Connector / Female Contacts) |
| 5A | 08 | Screw Thread | GA-080800-MM0-TSA* | GA-080800-FF0-TSA* | GA-080800-MF0-TSA* |

└─ T-Cable > M Series Sensor > M12

■ Customized - Upon Request

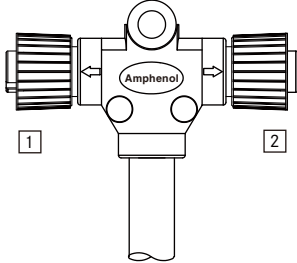

Choose Connector / Contacts Gender:

- 6 For connector 1
- 7 For connector 2

A/B/D Code
M: Male + Male
F: Female + Female
I Style
K: Connector (Male) + Contact (Male+Female)
Z: Connector (Female) + Contact (Male+Female)

* Choose the cable length: 0.1-99 m / PVC UL2464 Cable

| Type | Current Rating | Contacts 2 | Mating Style | Connector 1 (Male Connector / Male Contacts) | Connector 1 (Female Connector / Female Contacts) | More options | |
|------------------|----------------|---------------|--------------|---|---|--------------------|--------------------|
| | | | | Connector 2 (Male Connector / Male Contacts) | Connector 2 (Female Connector / Female Contacts) | | |
| M12 | A Code | 4A | 03,04,05 | Screw Thread | SS-2200-MM0-TSA* | SS-2200-FF0-TSA* | SS-2200-670-TSA* |
| | | 2A | 08 | | SS-080800-MM0-TSA* | SS-080800-FF0-TSA* | SS-080800-670-TSA* |
| | B Code | 4A | 04,05 | | SB-2200-MM0-TSA* | SB-2200-FF0-TSA* | SB-2200-670-TSA* |
| | D Code | 4A | 04,05 | | SD-2200-MM0-TSA* | SD-2200-FF0-TSA* | SD-2200-670-TSA* |
| | I Style | 4A | 05 | | SI-050500-KK0-TSA* | SI-050500-ZZ0-TSA* | SI-050500-670-TSA* |
| M12 (Plastic) | A Code | 4A | 03,04,05 | Screw Thread | PS-2200-MM0-TSA* | PS-2200-FF0-TSA* | PS-2200-670-TSA* |
| | | 2A | 08 | | PS-080800-MM0-TSA* | PS-080800-FF0-TSA* | PS-080800-670-TSA* |
| | B Code | 4A | 04,05 | | PB-2200-MM0-TSA* | PB-2200-FF0-TSA* | PB-2200-670-TSA* |
| | D Code | 4A | 04,05 | | PD-2200-MM0-TSA* | PD-2200-FF0-TSA* | PD-2200-670-TSA* |
| | I Style | 4A | 05 | | PI-050500-KK0-TSA* | PI-050500-ZZ0-TSA* | PI-050500-670-TSA* |

* Design and specification are subject to change without notice.

Y-Cable > M Series Sensor > M12

Customized - Upon Request

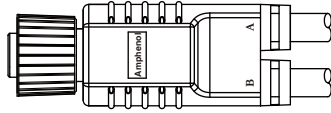

* Choose the cable length:01-99 m / PU VW-1Cable

| Type | | Current Rating | Contacts ② | Mating Style | Connector (Male Connector / Male Contacts) | Connector (Female Connector / Female Contacts) |
|------|---------|----------------|---------------|--------------|---|---|
| M12 | A Code | 4A | 03,04,05 | Screw Thread | SS- ② 0000-M00-YSB* | SS- ② 0000-F00-YSB* |
| | | 2A | 08 | Screw Thread | SS-080000-M00-YSB* | SS-080000-F00-YSB* |
| | B Code | 4A | 04,05 | Screw Thread | SB- ② 0000-M00-YSB* | SB- ② 0000-F00-YSB* |
| | D Code | 4A | 04,05 | Screw Thread | SD- ② 0000-M00-YSB* | SD- ② 0000-F00-YSB* |
| | I Style | 4A | 05 | Screw Thread | SI-050000-K00-YSB* | SI-050000-Z00-YSB* |

Accessories - Adaptor

└ T-Adaptor > Circular > Mini Size: 7/16"-28 UNS

■ Customized - Upon Request

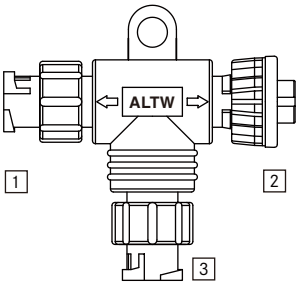

5 For connector 1
6 For connector 2
7 For connector 3

Choose Connector / Contacts Gender:
M: Male + Male
F: Female + Female

| Current Rating | Contacts 2 | Mating Style | Connector 1 (Male Connector / Male Contacts) | Connector 1 (Female Connector / Female Contacts) | More options |
|----------------|---------------|----------------------|---|---|--------------------------|
| | | | Connector 2 (Male Connector / Male Contacts) | Connector 2 (Female Connector / Female Contacts) | |
| | | | Connector 3 (Male Connector / Male Contacts) | Connector 3 (Female Connector / Female Contacts) | |
| 5A | 02,03 | Screw Thread | AA- 2 2 2 -MMM-TS001 | AA- 2 2 2 -FFF-TS001 | AA- 2 2 2 - 5 6 7 -TS001 |
| | | 2 point lock bayonet | AA- 2 2 2 -MMM-TL001 | AA- 2 2 2 -FFF-TL001 | AA- 2 2 2 - 5 6 7 -TL001 |
| 2A | 04,05,06 | Screw Thread | AA- 2 2 2 -MMM-TS001 | AA- 2 2 2 -FFF-TS001 | AA- 2 2 2 - 5 6 7 -TS001 |
| | | 2 point lock bayonet | AA- 2 2 2 -MMM-TL001 | AA- 2 2 2 -FFF-TL001 | AA- 2 2 2 - 5 6 7 -TL001 |

└ T-Adaptor > Circular > Standard Size: 5/8"-27 UNS

■ Customized - Upon Request

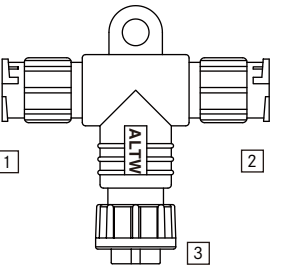

5 For connector 1
6 For connector 2
7 For connector 3

Choose Connector / Contacts Gender:
M: Male + Male
F: Female + Female
H: Male + Female
B: Female + Male

* Choose the cable length:01-99 m /
PVC UL2464 Cable

| Current Rating | Contacts 2 | Mating Style | Connector 1 (Male Connector / Male Contacts) | Connector 1 (Female Connector / Female Contacts) | More options |
|----------------|------------------------------|----------------------|---|---|--------------------------|
| | | | Connector 2 (Male Connector / Male Contacts) | Connector 2 (Female Connector / Female Contacts) | |
| | | | Connector 3 (Male Connector / Male Contacts) | Connector 3 (Female Connector / Female Contacts) | |
| 5A | 02,03,04, 05,06,07, 08 | Screw Thread | BA- 2 2 2 -MMM-TS001 | BA- 2 2 2 -FFF-TS001 | BA- 2 2 2 - 5 6 7 -TS001 |
| | | 2 point lock bayonet | BA- 2 2 2 -MMM-TL001 | BA- 2 2 2 -FFF-TL001 | BA- 2 2 2 - 5 6 7 -TL001 |
| 2A | 10, 12 | Screw Thread | BA- 2 2 2 -MMM-TS001 | BA- 2 2 2 -FFF-TS001 | BA- 2 2 2 - 5 6 7 -TS001 |
| | | 2 point lock bayonet | BA- 2 2 2 -MMM-TL001 | BA- 2 2 2 -FFF-TL001 | BA- 2 2 2 - 5 6 7 -TL001 |

* Design and specification are subject to change without notice.

└ T-Adaptor > M Series Sensor > M12

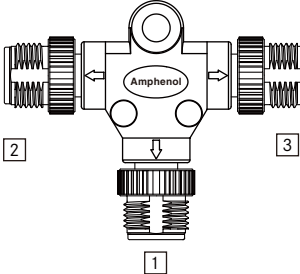
| <div style="display: flex; align-items: center;"> Customized - Upon Request </div> | | | | |  | | Choose Connector / Contacts Gender: 5 For connector 1 6 For connector 2 7 For connector 3 <u>A/B/D Code</u> M: Male + Male F: Female + Female <u>I Style</u> K: Connector (Male) + Contact (Male+Female) Z: Connector (Female) + Contact (Male+Female) | | |
|---|----------------|---------------|--------------|---|---|----------------------|---|--|--|
| Type | Current Rating | Contacts 2 | Mating Style | Connector 1 (Male Connector / Male Contacts) | Connector 1 (Female Connector / Female Contacts) | More options | | | |
| | | | | Connector 2 (Male Connector / Male Contacts) | Connector 2 (Female Connector / Female Contacts) | | | | |
| | | | | Connector 3 (Male Connector / Male Contacts) | Connector 3 (Female Connector / Female Contacts) | | | | |
| M 12 | A Code | 4A | 03,04,05 | Screw Thread | SS- 2 2 2 -MMM-TS001 | SS- 2 2 2 -FFF-TS001 | SS- 2 2 2 -5 6 7-TS001 | | |
| | | 2A | 08 | Screw Thread | SS-080808-MMM-TS001 | SS-080808-FFF-TS001 | SS-080808-5 6 7-TS001 | | |
| | B Code | 4A | 04,05 | Screw Thread | SB- 2 2 2 -MMM-TS001 | SB- 2 2 2 -FFF-TS001 | SB- 2 2 2 -5 6 7-TS001 | | |
| | D Code | 4A | 04,05 | Screw Thread | SD- 2 2 2 -MMM-TS001 | SD- 2 2 2 -FFF-TS001 | SD- 2 2 2 -5 6 7-TS001 | | |
| | I Style | 4A | 05 | Screw Thread | SI-050505-KKK-TS001 | SI-050505-ZZZ-TS001 | SI-050505-5 6 7-TS001 | | |
| M 12 (Plastic) | A Code | 4A | 03,04,05 | Screw Thread | PS- 2 2 2 -MMM-TS001 | PS- 2 2 2 -FFF-TS001 | PS- 2 2 2 -5 6 7-TS001 | | |
| | | 2A | 08 | Screw Thread | PS-080808-MMM-TS001 | PS-080808-FFF-TS001 | PS-080808-5 6 7-TS001 | | |
| | B Code | 4A | 04,05 | Screw Thread | PB- 2 2 2 -MMM-TS001 | PB- 2 2 2 -FFF-TS001 | PB- 2 2 2 -5 6 7-TS001 | | |
| | D Code | 4A | 04,05 | Screw Thread | PD- 2 2 2 -MMM-TS001 | PD- 2 2 2 -FFF-TS001 | PD- 2 2 2 -5 6 7-TS001 | | |
| | I Style | 4A | 05 | Screw Thread | PI-050505-KKK-TS001 | PI-050505-ZZZ-TS001 | PI-050505-5 6 7-TS001 | | |

Y-Adaptor > M Series Sensor > M12

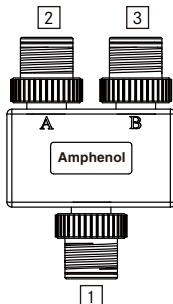
| | | Customized – Upon Request | |  | | Choose Connector / Contacts Gender: | |
|-------------------|----------------|---------------------------|--------------|---|---|-------------------------------------|---------------------|
| Type | Current Rating | Contacts 2 | Mating Style | Connector 1 (Male Connector / Male Contacts) | Connector 1 (Female Connector / Female Contacts) | More options | |
| | | | | Connector 2 (Male Connector / Male Contacts) | Connector 2 (Female Connector / Female Contacts) | | |
| | | | | Connector 3 (Male Connector / Male Contacts) | Connector 3 (Female Connector / Female Contacts) | | |
| M 12 | A Code | 4A | 03,04,05 | Screw Thread | SS-222-MMM-YS001 | SS-222-FFF-YS001 | SS-222-567-YS001 |
| | | 2A | 08 | Screw Thread | SS-080808-MMM-YS001 | SS-080808-FFF-YS001 | SS-080808-567-YS001 |
| | B Code | 4A | 04,05 | Screw Thread | SB-222-MMM-YS001 | SB-222-FFF-YS001 | SB-222-567-YS001 |
| | D Code | 4A | 04,05 | Screw Thread | SD-222-MMM-YS001 | SD-222-FFF-YS001 | SD-222-567-YS001 |
| | I Style | 4A | 05 | Screw Thread | SI-050505-KKK-YS001 | SI-050505-ZZZ-YS001 | SI-050505-567-YS001 |
| M 12 (Plastic) | A Code | 4A | 03,04,05 | Screw Thread | PS-222-MMM-YS001 | PS-222-FFF-YS001 | PS-222-567-YS001 |
| | | 2A | 08 | Screw Thread | PS-080808-MMM-YS001 | PS-080808-FFF-YS001 | PS-080808-567-YS001 |
| | B Code | 4A | 04,05 | Screw Thread | PB-222-MMM-YS001 | PB-222-FFF-YS001 | PB-222-567-YS001 |
| | D Code | 4A | 04,05 | Screw Thread | PD-222-MMM-YS001 | PD-222-FFF-YS001 | PD-222-567-YS001 |
| | I Style | 4A | 05 | Screw Thread | PI-050505-KKK-YS001 | PI-050505-ZZZ-YS001 | PI-050505-567-YS001 |

* Design and specification are subject to change without notice.

∨ I-Adaptor > Circular > Mini Size: 7/16"-28 UNS

■ Customized – Upon Request

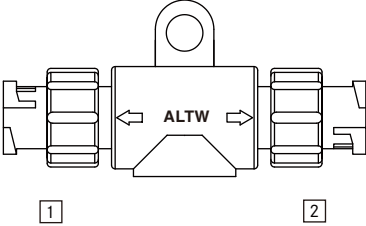

6 For connector 1
7 For connector 2

Choose Connector / Contacts Gender:
M: Male + Male
F: Female + Female

| Current Rating | Contacts ③ | Mating Style | Connector 1 (Male Connector / Male Contacts) | Connector 1 (Female Connector / Female Contacts) | More options |
|----------------|---------------|----------------------|---|---|-------------------------|
| | | | Connector 2 (Male Connector / Male Contacts) | Connector 2 (Female Connector / Female Contacts) | |
| 5A | 02,03 | Screw Thread | AA-00 ③ ③ -0MM-IS001 | AA-00 ③ ③ -0FF-IS001 | AA-00 ③ ③ -0 ⑥ ⑦ -IS001 |
| | | 2 point lock bayonet | AA-00 ③ ③ -0MM-IL001 | AA-00 ③ ③ -0FF-IL001 | AA-00 ③ ③ -0 ⑥ ⑦ -IL001 |
| 2A | 04,05,06 | Screw Thread | AA-00 ③ ③ -0MM-IS001 | AA-00 ③ ③ -0FF-IS001 | AA-00 ③ ③ -0 ⑥ ⑦ -IS001 |
| | | 2 point lock bayonet | AA-00 ③ ③ -0MM-IL001 | AA-00 ③ ③ -0FF-IL001 | AA-00 ③ ③ -0 ⑥ ⑦ -IL001 |

∨ I-Adaptor > Circular > Standard Size: 5/8"-27 UNS

■ Customized – Upon Request

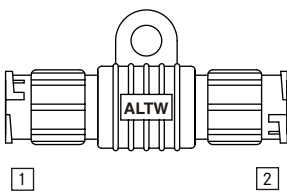

6 For connector 1
7 For connector 2

Choose Connector / Contacts Gender:
M: Male + Male
F: Female + Female
H: Male + Female
B: Female + Male

| Current Rating | Contacts ③ | Mating Style | Connector 1 (Male Connector / Male Contacts) | Connector 1 (Female Connector / Female Contacts) | More options |
|----------------|------------------------------|----------------------|---|---|-------------------------|
| | | | Connector 2 (Male Connector / Male Contacts) | Connector 2 (Female Connector / Female Contacts) | |
| 5A | 02,03,04, 05,06,07, 08 | Screw Thread | BA-00 ③ ③ -0MM-IS001 | BA-00 ③ ③ -0FF-IS001 | BA-00 ③ ③ -0 ⑥ ⑦ -IS001 |
| | | 2 point lock bayonet | BA-00 ③ ③ -0MM-IL001 | BA-00 ③ ③ -0FF-IL001 | BA-00 ③ ③ -0 ⑥ ⑦ -IL001 |
| 2A | 10,12 | Screw Thread | BA-00 ③ ③ -0MM-IS001 | BA-00 ③ ③ -0FF-IS001 | BA-00 ③ ③ -0 ⑥ ⑦ -IS001 |
| | | 2 point lock bayonet | BA-00 ③ ③ -0MM-IL001 | BA-00 ③ ③ -0FF-IL001 | BA-00 ③ ③ -0 ⑥ ⑦ -IL001 |

└ I-Adaptor > Circular > Other Size > Mix Size (10A+5A)

■ Customized - Upon Request

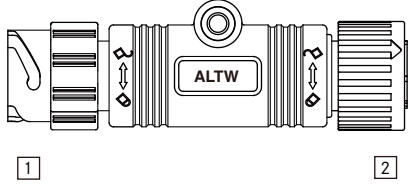

| Current Rating | Contacts | Mating Style | Connector 1 (Male Connector / Male Contacts) | Connector 1 (Female Connector / Female Contacts) | Connector 1 (Female Connector / Female Contacts) |
|----------------|----------|----------------------|---|---|---|
| | | | Connector 2 (Male Connector / Male Contacts) | Connector 2 (Female Connector / Female Contacts) | Connector 1 (Male Connector / Male Contacts) |
| 5A | 08 | 3 point lock bayonet | GA-000808-0MM-IT001 | GA-000808-OFF-IT001 | GA-000808-0FM-IT001 |

└ I-Adaptor > M Series Sensor > M12

■ Customized - Upon Request

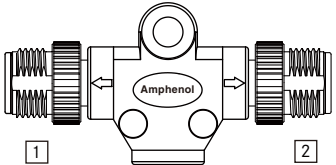

Choose Connector / Contacts Gender:

- 6 For connector 1
- 7 For connector 2

A/B/D Code
M: Male + Male
F: Female + Female
I Style
K: Connector (Male) + Contact (Male+Female)
Z: Connector (Female) + Contact (Male+Female)

| Type | Current Rating | Contacts 3 | Mating Style | Connector 1 (Male Connector / Male Contacts) | Connector 1 (Female Connector / Female Contacts) | More options | |
|------------------|----------------|---------------|--------------|---|---|----------------------|--|
| | | | | Connector 2 (Male Connector / Male Contacts) | Connector 2 (Female Connector / Female Contacts) | | |
| M12 | A Code | 4A | 03,04,05 | Screw Thread | SS-00 3 3 -0MM-IS001 | SS-00 3 3 -OFF-IS001 | SS-00 3 3 -0 6 7 -IS001 |
| | | 2A | 08 | Screw Thread | SS-000808-0MM-IS001 | SS-000808-OFF-IS001 | SS-000808-0 6 7 -IS001 |
| | B Code | 4A | 04,05 | Screw Thread | SB-00 3 3 -0MM-IS001 | SB-00 3 3 -OFF-IS001 | SB-00 3 3 -0 6 7 -IS001 |
| | | 4A | 04,05 | Screw Thread | SD-00 3 3 -0MM-IS001 | SD-00 3 3 -OFF-IS001 | SD-00 3 3 -0 6 7 -IS001 |
| | I Style | 4A | 05 | Screw Thread | SI-000505-0KK-IS001 | SI-000505-0ZZ-IS001 | SI-000505-0KZ-IS001 SI-000505-0ZK-IS001 |
| M12 (Plastic) | A Code | 4A | 03,04,05 | Screw Thread | PS-00 3 3 -0MM-IS001 | PS-00 3 3 -OFF-IS001 | PS-00 3 3 -0 6 7 -IS001 |
| | | 2A | 08 | Screw Thread | PS-000808-0MM-IS001 | PS-000808-OFF-IS001 | PS-000808-0 6 7 -IS001 |
| | B Code | 4A | 04,05 | Screw Thread | PB-00 3 3 -0MM-IS001 | PB-00 3 3 -OFF-IS001 | PB-00 3 3 -0 6 7 -IS001 |
| | | 4A | 04,05 | Screw Thread | PD-00 3 3 -0MM-IS001 | PD-00 3 3 -OFF-IS001 | PD-00 3 3 -0 6 7 -IS001 |
| | I Style | 4A | 05 | Screw Thread | PI-000505-0KK-IS001 | PI-000505-0ZZ-IS001 | PI-000505-0KZ-IS001 PI-000505-0ZK-IS001 |

* Design and specification are subject to change without notice.

Accessories - Cap

∟ Dust Cap >Circular

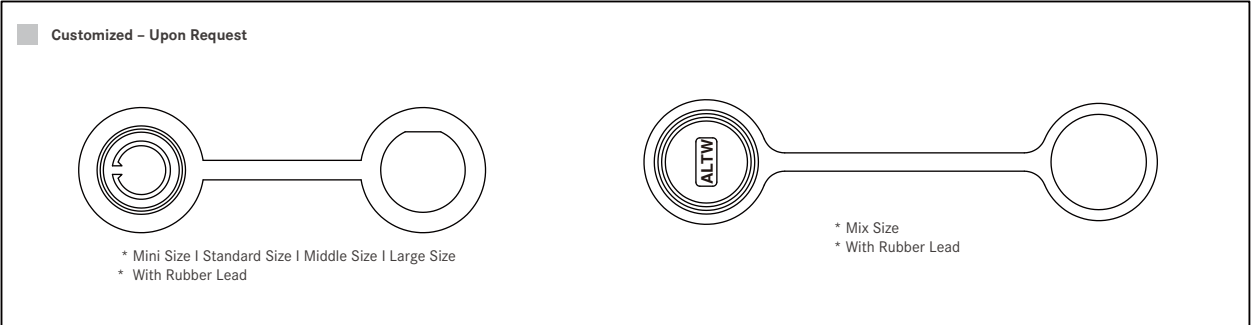

| Size | Mating Pair | Mating Pair (Gender) | P/N |
|------------------------------|-----------------------|----------------------|---|
| Mini Size 7/16"-28 UNS | Receptacle | Male | CAP-DAAMDPC 1 |
| Standard Size 5/8"-27 UNS | Receptacle | Male | CAP-DABMDPC 1 CAP-DABMDPC 2 CAP-DABMDPC 3 |
| | | Female | - |
| | Overmolded with Cable | Male | CAP-DABMDCC 1 CAP-DABMDCC 2 |
| | | Female | CAP-DABFDCC 1 |
| Middle Size 13/16"-28 UNS | Receptacle | Male | CAP-DACMDPC 1 CAP-DACMDPC 2 |
| | Overmolded with Cable | Female | CAP-DACFDCC 1 |
| Large Size 1"-20 UNEF | Receptacle | Male | CAP-DADMDPC 1 |
| Mix Size 12-5A | Receptacle | Male | CAP-DPLMDPC 1 |

▾ Dust Cap > D-SUB > Standard & High Density

■ Customized - Upon Request

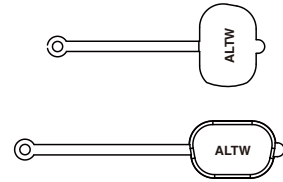
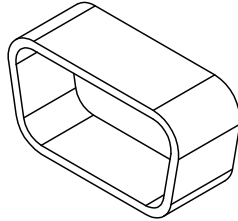

*Choose rubber lead: Vertical type (1) / Horizontal type (2)

| Type | | Mating Pairs | Mating Pair (Gender) | P/N |
|--------------------|------------------------|--|----------------------|--------------------------------|
| Standard D-SUB | High Density D-SUB | | | |
| Standard (9 pins) | High Density (15 Pins) | Receptacle (With horizontal rubber lead) | Male | CAP-DD1MDPC2 |
| | | Receptacle and Overmolded with Cable (With horizontal / Vertical rubber lead) | | CAP-DD1MDMA1 |
| | | Receptacle | Female | CAP-DD1FDPC1* CAP-DD1FDPC2* |
| | | Receptacle and Overmolded with Cable | | CAP-DD1FDMA1 |
| Standard (15 pins) | High Density (26 Pins) | Receptacle and Overmolded with Cable | Male | CAP-DD2MDMA1 |
| | | Receptacle and Overmolded with Cable | Female | CAP-DD2FDMA1 |
| Standard (25 pins) | High Density (44 Pins) | Receptacle and Overmolded with Cable | Male | CAP-DD3MDMA1 |
| | | Receptacle (With horizontal rubber lead) | Female | CAP-DD3FDPC1 |
| | | Receptacle and Overmolded with Cable | | CAP-DD3FDMA1 |

* Design and specification are subject to change without notice.

Waterproof Cap >Circular

■ Customized - Upon Request

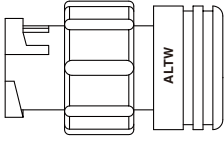

* Mini Size

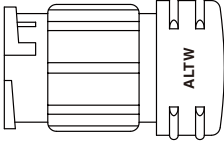

* Standard Size

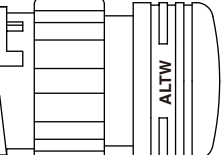

* Middle Size

Choose Connector / Contacts Gender:

6 More to choose: None(A) / With Chain(B) / With Rubber Lead(C) / With Fish Line(D)

7 Choose 2 contacts(1) / 3 contacts(3) / 4~6 contacts(2) for male mating pair

| Size | Mating Pair | Mating Style | Mating Pair (Gender) | P/N | |
|--------------------------------------|------------------------------|--------------------------------------|-------------------------------|-------------------------------|-------------------------------|
| Mini Size 7/16"-28 UNS | Receptacle | Screw Thread | Male | CAP-WAAMSP 6 1 | |
| | | 2 point lock bayonet | Male | CAP-WAAML P 6 7 | |
| | | | Female | CAP-WAAFL P 6 7 | |
| | Overmolded with Cable | Screw Thread | Male | CAP-WAAMSMA 1 | |
| | | 2 point lock bayonet | Male | CAP-WAAMLMA 7 | |
| | | | Female | CAP-WAAFLMA 7 | |
| | | Receptacle and Overmolded with Cable | Screw Thread | Male | CAP-WAAMSMA 1 |
| | 2 point lock bayonet | | Male | CAP-WAAMLMA 7 | |
| | | | Female | CAP-WAAFLMA 7 | |
| | Standard Size 5/8"-27 UNS | Receptacle | Screw Thread | Male | CAP-WABMSP 6 1 |
| | | | 2 point lock bayonet | Female | CAP-WABFSP 6 1 |
| | | | | Male | CAP-WABML P 6 7 |
| Female | | | CAP-WABFL P 6 7 | | |
| Overmolded with Cable | | Screw Thread | Male | CAP-WABMSMA 1 | |
| | | 2 point lock bayonet | Female | CAP-WABFSMA 1 | |
| | | | Male | CAP-WABMLMA 7 | |
| | | Female | CAP-WABFLMA 7 | | |
| Receptacle and Overmolded with Cable | | Screw Thread | Male | CAP-WABMSMA 1 | |
| | | 2 point lock bayonet | Female | CAP-WABFSMA 1 | |
| | | | Male | CAP-WABMLMA 7 | |
| | | Female | CAP-WABFLMA 7 | | |
| Middle Size 13/16"-28 UNS | Receptacle | Screw Thread | Male | CAP-WACMSP 6 7 | |
| | | 2 point lock bayonet | Male | CAP-WACML P 6 1 | |
| | | | Female | CAP-WACFL P 6 1 | |
| | Overmolded with Cable | Screw Thread | Male | CAP-WACMSMA 7 | |
| | | 2 point lock bayonet | Male | CAP-WACMLMA 1 | |
| | | | Female | CAP-WACFLMA 1 | |
| | | Receptacle and Overmolded with Cable | Screw Thread | Male | CAP-WACMSMA 7 |
| | 2 point lock bayonet | | Male | CAP-WACMLMA 1 | |
| | | | Female | CAP-WACFLMA 1 | |

Waterproof Cap >Circular

■ Customized - Upon Request

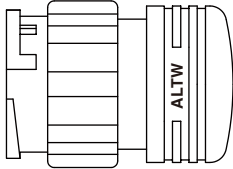

* Large Size

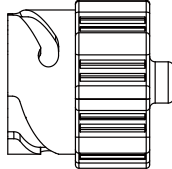

* Mix Size

⑥ More to choose: None(A) / With Chain(B) / With Rubber Lead(C) / With Fish Line(D)

⑦ Choose 18 contacts(2) for female mating pair

| Size | Mating Pair | Mating Style | Mating Pair (Gender) | P/N |
|---|---|----------------------|----------------------|----------------|
| Large Size 1"-20 UNEF | Receptacle | Screw Thread | Male | CAP-WADMSP ⑥ 1 |
| | | 2 point lock bayonet | Male | CAP-WADMLP ⑥ ⑦ |
| | Overmolded with Cable | 2 point lock bayonet | Female | CAP-WADFLP ⑥ ⑦ |
| | | Screw Thread | - | - |
| | Receptacle and Overmolded with Cable | 2 point lock bayonet | - | - |
| | | Screw Thread | Male | CAP-WADMSMA1 |
| | | | Female | CAP-WADFLMA ⑦ |
| | | 2 point lock bayonet | Male | CAP-WADMLMA ⑦ |
| Mix Size (Between Standard & Middle Size) | Receptacle | 3 Points Lock | Female | CAP-WADFLMA ⑦ |
| | | | Male | CAP-WEBMLP ⑥ 1 |
| | Receptacle and Overmolded with Cable | 3 Points Lock | Female | CAP-WEBFLP ⑥ 1 |
| | | | Male | CAP-WEBMLMA1 |
| | | 3 Points Lock | Male | CAP-WEBMLMA1 |
| | | | Female | CAP-WEBFLMA1 |

* Design and specification are subject to change without notice.

Waterproof Cap > Power

Customized - Upon Request

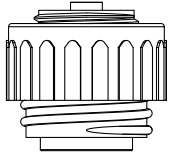

* 8A (PWE) | 12A (PWF) | 16A (PWG)

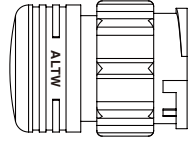

* 20A (PWC) | 20A+2A (PWCU)

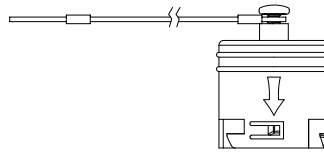

* 25A (PWH) | 30A (PWJ)

6 More to choose: None(A) / With Chain(B) / With Rubber Lead(C) / With Fish Line(D)

| Current Rating | Mating Pair | Mating Style | Mating Pair (Gender) | P/N | |
|----------------|--------------------------------------|----------------------|----------------------|----------------|--|
| 8A(PWE) | Receptacle | Screw Thread | Male | CAP-WTAMSP 6 1 | |
| | | | Female | CAP-WTAFSP 6 1 | |
| | Receptacle and Overmolded with Cable | | Male | CAP-WTAMSMA1 | |
| | Female | | CAP-WTAFSMA1 | | |
| 12A(PWF) | Receptacle | Screw Thread | Male | CAP-WTAMSP 6 1 | |
| | | | Female | CAP-WTAFSP 6 1 | |
| | Receptacle and Overmolded with Cable | | Male | CAP-WTAMSMA1 | |
| | Female | | CAP-WTAFSMA1 | | |
| 16A(PWG) | Receptacle | Screw Thread | Male | CAP-WTAMSP 6 1 | |
| | | | Female | CAP-WTAFSP 6 1 | |
| | Receptacle and Overmolded with Cable | | Male | CAP-WTAMSMA1 | |
| | Female | | CAP-WTAFSMA1 | | |
| 20A(PWC) | Receptacle | 2 point lock bayonet | Male | CAP-WACMLP 6 1 | |
| | Receptacle and Overmolded with Cable | | | CAP-WACMLMA1 | |
| | Receptacle and Overmolded with Cable | | Female | CAP-WACFLMA2 | |
| 20A+2A(PWCU) | Receptacle | 2 point lock bayonet | Male | CAP-WACMLP 6 1 | |
| | Receptacle and Overmolded with Cable | | | CAP-WACMLMA1 | |
| | Receptacle and Overmolded with Cable | | Female | CAP-WACFLMA2 | |
| 25A(PWH) | Receptacle and Overmolded with Cable | 3 point lock bayonet | Female | CAP-WPWFTMD1 | |
| 30A(PWJ) | Receptacle and Overmolded with Cable | 3 point lock bayonet | Male | CAP-WPWMTMD1 | |

Waterproof Cap > Sensor > M8

Customized - Upon Request

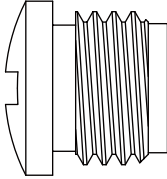

For Female

| Size | Mating Pair | Mating Style | Mating Pair (Gender) | P/N |
|------|--------------------------------------|--------------|----------------------|--------------|
| M8 | Overmolded with Cable | Screw Thread | Female | CAP-WBBFSCC1 |
| | Receptacle and Overmolded with Cable | Screw Thread | Male | CAP-WBBMSMA1 |
| | | | Female | CAP-WBBFSMA1 |

Waterproof Cap > Sensor > M10.5

Customized - Upon Request

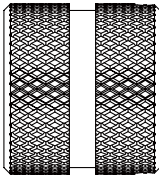

For male

| Size | Mating Pair | Mating Style | Mating Pair (Gender) | P/N |
|--------|--------------------------------------|--------------|----------------------|--------------|
| M 10.5 | Receptacle and Overmolded with Cable | Screw Thread | Male | CAP-WBCMSMA2 |

* Design and specification are subject to change without notice.

Waterproof Cap > Sensor > M12

Customized – Upon Request

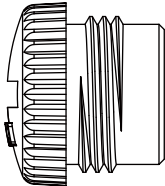

7 Choose plastic(1) or metal(2) items

| Size | Size | Mating Pair | Mating Style | Mating Pair (Gender) | P/N |
|--------------|-----------------------|--------------------------------------|--------------|----------------------|----------------|
| M12 | A/B/D Code I Style | Receptacle | Screw Thread | Male | CAP-WBDPMSB1 |
| | | Receptacle and Overmolded with Cable | Screw Thread | Male | CAP-WBDMSMA 7 |
| Female | CAP-WBDFSMA 7 | | | | |
| M12(Plastic) | A/B/D Code I Style | Receptacle and Overmolded with Cable | Screw Thread | Male | CAP-WBDMSMA1 7 |
| | | | | Female | CAP-WBDFSMA1 7 |

Waterproof Cap > Sensor > Heavy Duty Shielded Connectors

Customized – Upon Request

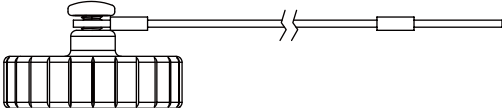

| Size | Mating Pair | Mating Style | Mating Pair (Gender) | P/N |
|------|-------------|--------------|----------------------|--------------|
| M22 | Receptacle | Screw Thread | Male | CAP-WHBMSPD1 |

Waterproof Cap > Sensor > M23

Customized – Upon Request

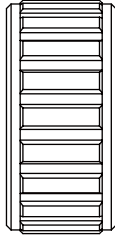

| Size | Mating Pair | Mating Style | Mating Pair (Gender) | P/N |
|------|--------------------------------------|--------------|----------------------|--------------|
| M23 | Receptacle and Overmolded with Cable | Screw Thread | Male | CAP-WBHMSMA1 |

Waterproof Cap > USB | IEEE 1394

■ Customized - Upon Request

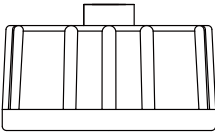

* USB Screw (Mating Pair: Male)

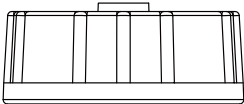

* USB Lock



* USB Screw (Mating Pair: Female)

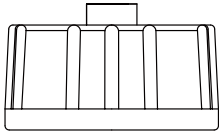

* IEEE 1394

⑥ More to choose: None(A) / With Chain(B) / With Rubber Lead(C) / With Fish Line(D)

| Type | Mating Pair | Mating Style | Mating Pair (Gender) | P/N |
|--|--------------------------------------|----------------------|----------------------|----------------|
| USB 2.0 Type A USB 2.0 Type B USB 3.0 Type A | Receptacle | Screw Thread | Male | CAP-WACMSP ⑥ 1 |
| | | 2 point lock bayonet | Male | CAP-WADMLP ⑥ 1 |
| | Receptacle and Overmolded with Cable | Screw Thread | Male | CAP-WACMSMA1 |
| | | 2 point lock bayonet | Male | CAP-WADMLMA1 |
| | Overmolded with Cable | Screw Thread | Female | CAP-WUSFSCC1 |
| IEEE 1394 | Receptacle | Screw Thread | Male | CAP-WACMSP ⑥ 1 |
| | Receptacle and Overmolded with Cable | Screw Thread | Male | CAP-WACMSMA1 |

Waterproof Cap > D-SUB | DVI

■ Customized - Upon Request

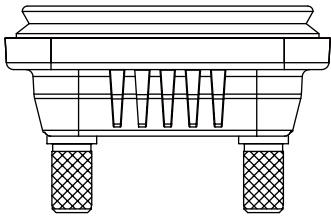

⑦ Choose rubber lead: Vertical type (1) / Horizontal type (2)

| Type | | Mating Pairs | Mating Style | Mating Pair (Gender) | P/N |
|--------------------|------------------------|--------------|--------------|----------------------|--------------|
| Standard D-SUB | High Density D-SUB | | | | |
| Standard (9 pins) | High Density (15 Pins) | Receptacle | Screw Thread | Male & Female | CAP-WD1CSPA1 |
| Standard (15 pins) | High Density (26 Pins) | Receptacle | Screw Thread | Male & Female | CAP-WD2CSPA1 |
| Standard (25 pins) | High Density (44 Pins) | Receptacle | Screw Thread | Male & Female | CAP-WD3CSPA1 |
| DVI | | Receptacle | Screw Thread | Male & Female | CAP-WDVCSPA1 |

* Design and specification are subject to change without notice.

Waterproof Cap > RJ

■ Customized - Upon Request

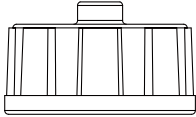

* RJ C 3 Point Lock

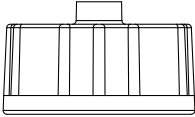

* RJ C Screw

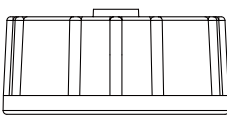

* RJ D Screw

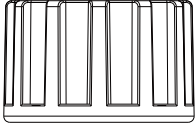

* RJ ODVA 3 Point Lock

6 More to choose: None(A) / With Chain(B)
/ With Rubber Lead(C) / With Fish Line(D)

7 Choose plastic (1) or metal (2) items

| Size | Mating Pair | Mating Style | Mating Pair (Gender) | P/N |
|--------|-------------|----------------------|----------------------|---------------------------------|
| C Size | Receptacle | 3 point lock bayonet | Male | CAP-WACMTMA1 CAP-WACMTP 6 1 |
| | | Screw Thread | Male | CAP-WACMSMA 7 CAP-WACMSP 6 7 |
| D Size | Receptacle | Screw Thread | Male | CAP-WADMSMA1 CAP-WADMSP 6 1 |
| ODVA | Receptacle | 3 point lock bayonet | Male | CAP-WEOFTPC1 |

Waterproof Cap > HDMI

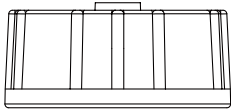

* D Size (Circular Type)

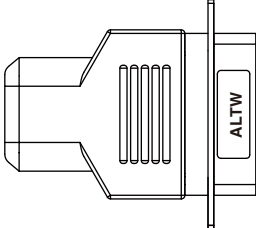

* Rectangle Type

| Size | Mating Pair | Mating Style | Mating Pair (Gender) | P/N |
|------------------------|-------------|--------------|----------------------|---------------|
| D Size (Circular Type) | Receptacle | Screw Thread | Male | CAP-WADMSMA 1 |
| Rectangle Type | Receptacle | Latch Type | Female | CAP-WHDFLPA1 |

Waterproof Cap > Fiber Optic

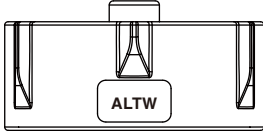
| <input type="checkbox"/> Customized - Upon Request | | | | |
|---|--------------------------------------|----------------------|----------------------|--------------|
|  | | | | |
| 7 Choose rubber lead: Vertical type (1) / Horizontal type (2) | | | | |
| Size | Mating Pair | Mating Style | Mating Pair (Gender) | P/N |
| Fiber Optic | Receptacle and Overmolded with Cable | 3 point lock bayonet | Female | CAP-WFBFTMA1 |

Dummy > Circular > Middle Size: 13/16"-28 UNS

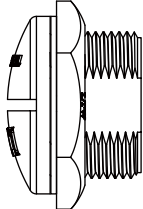
| <input type="checkbox"/> Customized - Upon Request | | | |
|--|---------------------|--------------|--------------|
|  | | | |
| Size | Mating Pair | Mating Style | P/N |
| 13/16"-28 UNS | Receptacle (Female) | Screw Thread | CAP-CACFSBA1 |

* Design and specification are subject to change without notice.

Accessories - Multi-port

Multi-port > Circular > Mini Size: 7/16"-28 UNS

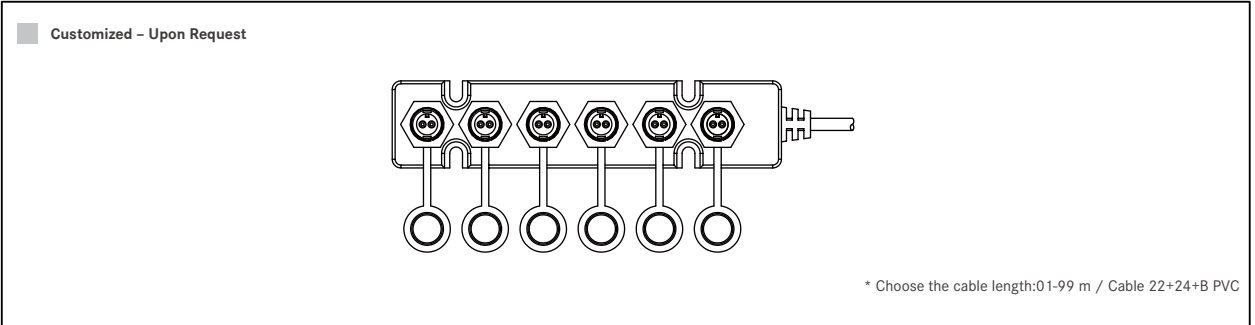

| Current Rating | Contacts 2 | Mating Style | Connector 1 (Male Connector / Male Contacts) | Connector 1 (Male Connector / Female Contacts) | More options |
|----------------|---------------|----------------------|---|---|-----------------------------------|
| | | | Connector 2 (Male Connector / Male Contacts) | Connector 2 (Male Connector / Female Contacts) | |
| | | | Connector 3 (Male Connector / Male Contacts) | Connector 3 (Male Connector / Female Contacts) | |
| | | | Connector 4 (Male Connector / Male Contacts) | Connector 4 (Male Connector / Female Contacts) | |
| | | | Connector 5 (Male Connector / Male Contacts) | Connector 5 (Male Connector / Female Contacts) | |
| | | | Connector 6 (Male Connector / Male Contacts) | Connector 6 (Male Connector / Female Contacts) | |
| 5A | 02,03 | Screw Thread | A-2 2 2 2 2 2-MMMMMM-SA* | A-2 2 2 2 2 2-HHHHHH-SA* | A-2 2 2 2 2-7 8 9 10 11 12 13-SA* |
| | | 2 point lock bayonet | A-2 2 2 2 2 2-MMMMMM-LA* A-22222-MMMMMM-LA01 | A-2 2 2 2 2 2-HHHHHH-LA* | A-2 2 2 2 2-7 8 9 10 11 12 13-LA* |
| 2A | 04,05,06 | Screw Thread | A-2 2 2 2 2 2-MMMMMM-SA* | A-2 2 2 2 2 2-HHHHHH-SA* | A-2 2 2 2 2-7 8 9 10 11 12 13-SA* |
| | | 2 point lock bayonet | A-2 2 2 2 2 2-MMMMMM-LA* | A-2 2 2 2 2 2-HHHHHH-LA* | A-2 2 2 2 2-7 8 9 10 11 12 13-LA* |

Multi-port > Circular > Standard Size: 5/8"-27 UNS

Customized - Upon Request

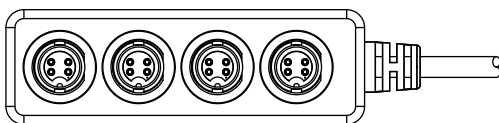

- 6 For connector 1
- 7 For connector 2
- 8 For connector 3
- 9 For connector 4

Choose Connector / Contacts Gender:

- M: Male + Male
- F: Female + Female

* Choose the cable length:01-99 m /
Cable 22+24+B PVC

| Current Rating | Contacts 2 | Mating Style | Connector 1 (Male Connector / Male Contacts) | Connector 1 (Male Connector / Female Contacts) | More options |
|----------------|------------------------------|----------------------|---|---|-------------------------|
| | | | Connector 2 (Male Connector / Male Contacts) | Connector 2 (Male Connector / Female Contacts) | |
| | | | Connector 3 (Male Connector / Male Contacts) | Connector 3 (Male Connector / Female Contacts) | |
| | | | Connector 4 (Male Connector / Male Contacts) | Connector 4 (Male Connector / Female Contacts) | |
| 10A | 02,03,04 | Screw Thread | B-2 2 2 2 -MMMMMM-SA* | B-2 2 2 2 -HHHHHH-SA* | B-2 2 2 2 -6 7 8 9 -SA* |
| | | 2 point lock bayonet | B-2 2 2 2 -MMMMMM-LA* | B-2 2 2 2 -HHHHHH-LA* | B-2 2 2 2 -6 7 8 9 -LA* |
| 5A | 02,03,04, 05,06,07, 08 | Screw Thread | B-2 2 2 2 -MMMMMM-SA* | B-2 2 2 2 -HHHHHH-SA* B-04040404-HHHH-SA* | B-2 2 2 2 -6 7 8 9 -SA* |
| | | 2 point lock bayonet | B-2 2 2 2 -MMMMMM-LA* | B-2 2 2 2 -HHHHHH-LA* | B-2 2 2 2 -6 7 8 9 -LA* |
| 2A | 10, 12 | Screw Thread | B-2 2 2 2 -MMMMMM-SA* | B-2 2 2 2 -HHHHHH-SA* | B-2 2 2 2 -6 7 8 9 -SA* |
| | | 2 point lock bayonet | B-2 2 2 2 -MMMMMM-LA* | B-2 2 2 2 -HHHHHH-LA* | B-2 2 2 2 -6 7 8 9 -LA* |

* Design and specification are subject to change without notice.

Accessories - Box

└ Box > USB > 2.0 Type A, 2.0 Type B

■ Customized - Upon Request

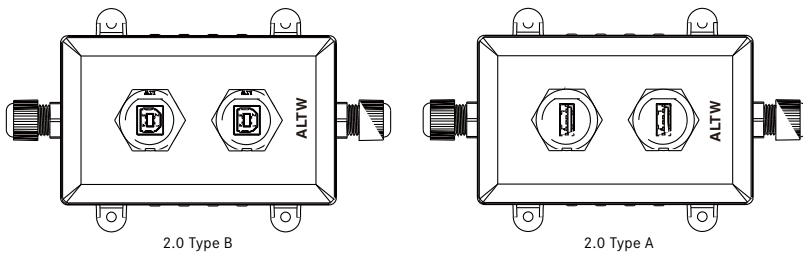

| Type | Ports | P/N |
|------------|-------|-----------|
| 2.0 Type A | 1 | BOX-USA11 |
| | 2 | BOX-USA22 |
| | 4 | BOX-USA44 |
| 2.0 Type B | 1 | BOX-USB11 |
| | 2 | BOX-USB22 |
| | 4 | BOX-USB44 |

Accessories - Tool

Wrench > Circular > Standard Size:
5/8"-27 UNS

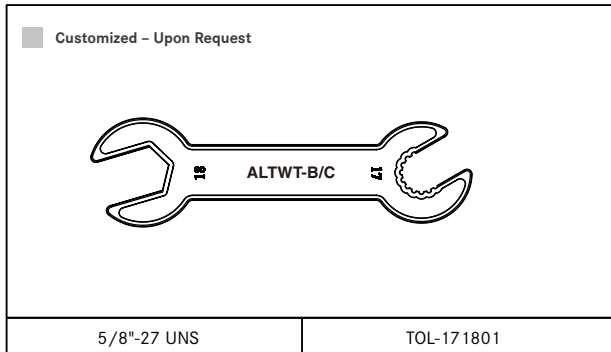

Wrench > Circular > Middle Size:
13/16"-28 UNS

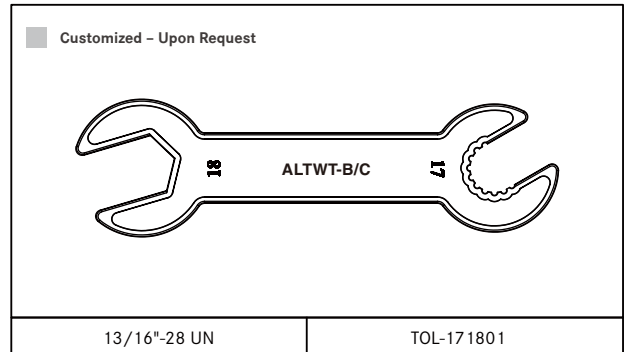

Wrench > Circular > Large Size:
1"-20 UNEF

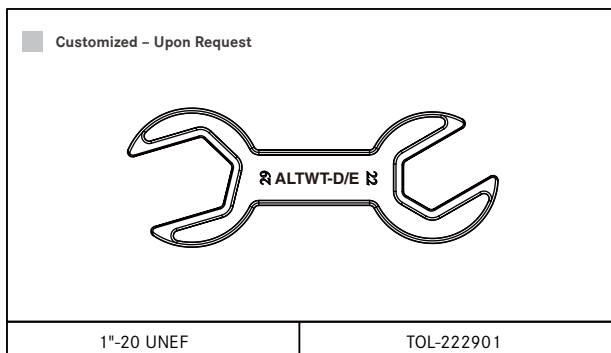

Unlock Tool > Cable Joiner >
8~10mm/10~12mm/12~16mm

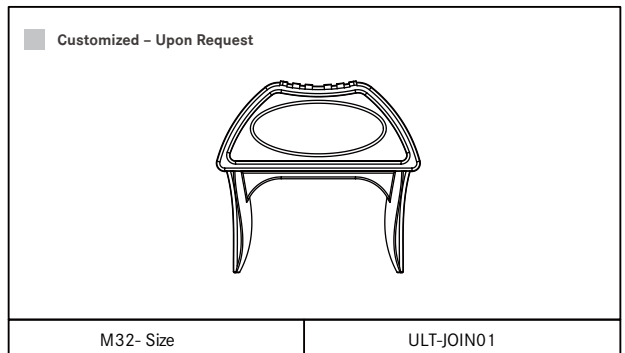

* Design and specification are subject to change without notice.

Accessories - Joint

∟ Joint > D-SUB > Standard & High Density

■ Customized - Upon Request

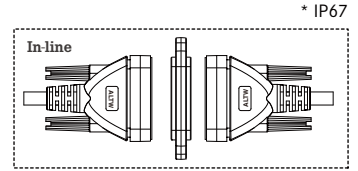
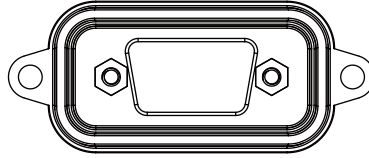

| Type | | Mating Style | P/N |
|--------------------|------------------------|--------------|-------------------|
| Standard D-SUB | High Density D-SUB | | |
| Standard (9 pins) | High Density (15 Pins) | Screw Thread | DJ1-00JNNA-SL7001 |
| Standard (15 pins) | High Density (26 Pins) | Screw Thread | DJ2-00JNNA-SL7001 |
| Standard (25 pins) | High Density (44 Pins) | Screw Thread | DJ3-00JNNA-SL7001 |

Accessories - Patch Cable (Double-ended)

▾ Patch Cable (Double-ended) > RJ

■ Customized - Upon Request

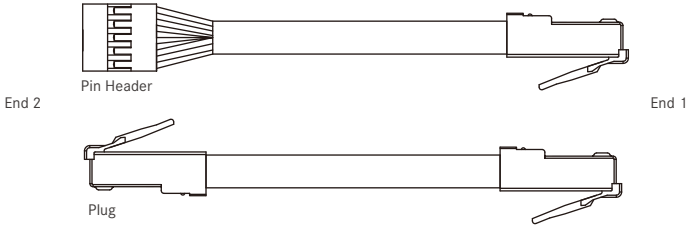

Gold Plated 6u"
Pitch 2.54mm
Select cable length 10cm/20cm/30cm

| End 1 | | End 2 | | P/ N |
|------------------|--------|------------------|------------|-----------------|
| Type | Gender | Type | Gender | |
| RJ 45 Unshielded | Plug | RJ 45 Unshielded | Plug | UPG06-CHOP1-C10 |
| | | | Pin Header | UPG06-UPG06-C10 |

* Design and specification are subject to change without notice.