

Part Number*	Relay Description
CA00HD	1A, 250 Vrms, AC Solid-State Relay with dual in-line terminals.
SCA00HD	1A, 250 Vrms, AC Solid-State Relay with gull wing surface mount terminals.

* The Y suffix denotes parameters tested to MIL-PRF-28750 test methods. The W suffix denotes parameters tested to Teledyne specifications.

ELECTRICAL SPECIFICATIONS

(-55°C TO +105°C UNLESS OTHERWISE SPECIFIED)

INPUT (CONTROL) CHARACTERISTICS

2 Terminal Configuration (See Fig. 1)	Min	Max	Units
Input Voltage	3.8	32	Vdc
Input Current (See Figure 1)			
$V_{IN} = 5$ Vdc	13	15	mA
$V_{IN} = 32$ Vdc	13	18	mA
Turn-Off Voltage (Guaranteed Off)		1.5	Vdc
Turn-On Voltage (Guaranteed On)	3.8		Vdc
Reverse Voltage Protection		-32	Vdc

BLOCK DIAGRAM

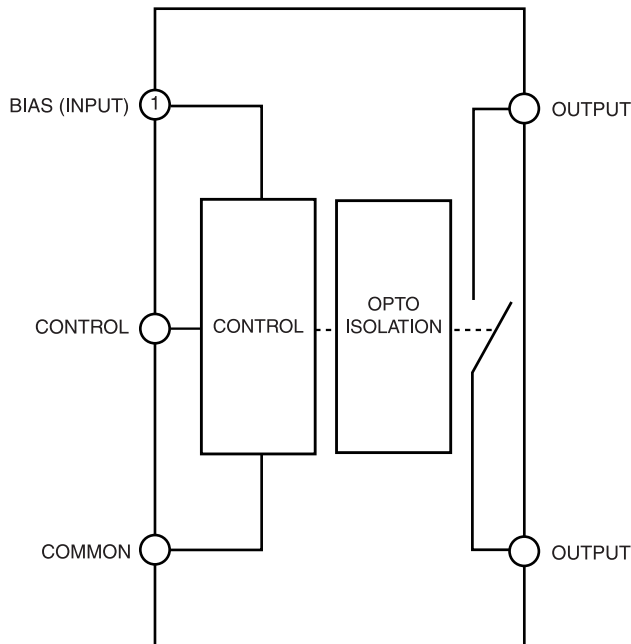

FEATURES/BENEFITS

- Optical Isolation: Isolates control elements from load transients.
- Low Zero Cross Window: Minimizes switching transients and lowers EMI. Ideal as an SCR or TRIAC driver.
- Fully Floating Output: Eliminates ground potential loops
- Meets MIL-STD-704 Requirements for Relay Outputs: Allows relay to be used in avionic systems without external transient protection.
- Buffered Control: Relay can be controlled directly from TTL or CMOS logic circuits.
- Low-Profile Ceramic DIP Package: Allows high-density packaging for through-hole and surface-mount applications.

DESCRIPTION

The Series CA is designed for printed circuit board mounting in AC power switching applications. The relay is rated for 1A at 250 Vrms from 40 to 440 Hz for resistive and reactive loads with power factors as low as 0.2. Inverse parallel SCRs are configured for zero voltage turn on. The patented circuit design assures the lowest possible EMI by reducing commutation spikes. Optical isolation allows a floating output with 1200 Vac isolation between the control (input) and load (output). This allows low level logic circuits to safely control AC loads. The low profile ceramic DIP package is hermetically sealed to withstand severe environmental conditions encountered in military and aerospace applications. This relay is available with conventional leads for through-hole PCB mounting or with gull wing leads for surface mount applications.

ELECTRICAL SPECIFICATIONS

(-55°C TO +105°C UNLESS OTHERWISE SPECIFIED)

INPUT (CONTROL) SPECIFICATIONS

3 TERMINAL CONFIGURATION (SEE FIG. 1)	Min	Max	Units
Bias Voltage	3.8	32	Vdc
Bias Current ($V_{IN}=32$ Vdc)		16	mA
(See Figure 2)			
Control Voltage Range	0	18	Vdc
Control Current (at 5 Vdc)		250	μ Acd
Turn-On Control Voltage		0.3	Vdc
Turn-Off Control Voltage	3.2		Vdc

OUTPUT (LOAD) SPECIFICATIONS

	Min	Max	Units
Output Current Rating (See Figure 3)	0.1	1.0	Arms
Output Voltage Rating	20	250	Vrms
Frequency Range	40	440	Hz
Output Voltage Drop @ 1 Amp		1.5	Vrms
Off-State Leakage Current (250 Vac, 400 Hz)		1.0	mArms
Turn-On Time		1/2	Cycle
Turn-Off Time		1	Cycle
Transient Voltage ($T < 5$ s) (see Note 4)		± 500	Vpk
Surge Current @ 25°C (16 ms)		5.6	Apk
Zero Voltage Turn-On Point		± 18	Vpk
dv/dt (See Note 1)	100		V/ μ s
Load Power Factor	0.2	1	
Insulation Resistance @ 500 Vdc	10^9		Ohms
Input to Output Capacitance		5	pF
Dielectric Withstanding Voltage (60Hz)	1200		Vac
Junction Temperature at Rated Current (T_J Max)		130	°C
Thermal Resistance Junction to Ambient (θ_{JA})		85	°C/W

MECHANICAL SPECIFICATIONS

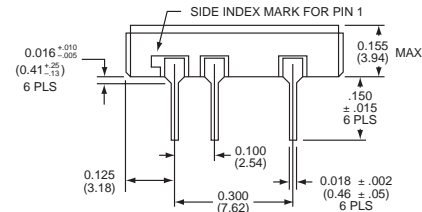
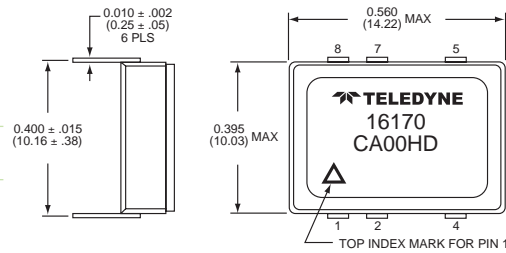

PIN-OUTS	
PIN NO.	FUNCTION
1	V(BIAS)
2	V(CNTRL)
4	LOAD
5	LOAD
7	N/C
8	INPUT COM.

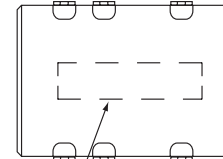

PCB STYLE MECHANICAL OUTLINE

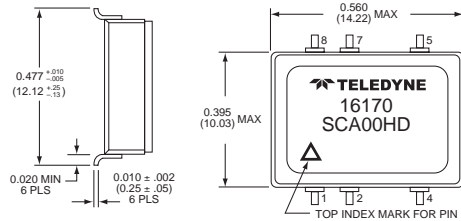

PIN-OUTS	
PIN NO.	FUNCTION
1	V(BIAS)
2	V(CNTRL)
4	LOAD
5	LOAD
7	N/C
8	INPUT COM.

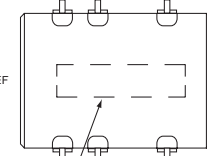
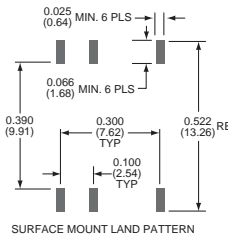
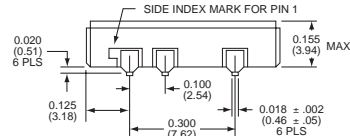

SMT STYLE MECHANICAL OUTLINE

TOLERANCES: XX= ±.010 (±.25), XXX= ±.005 (±.13)
DIMENSION STYLES: XXX= INCHES (XXX)= MILLIMETERS
CONTROLLING DIMENSIONS ARE IN INCHES. METRIC DIMENSIONS ARE SUPPLIED FOR REFERENCE PURPOSES ONLY.

- WEIGHT: 2 gm max
- CASE: DIP, hermetically sealed, ceramic
- PINS: Gold plated

ENVIRONMENTAL SPECIFICATIONS

Ambient Temperature	-55° C to +105° C Operating -55° C to +130° C Storage
Acceleration	5000 g

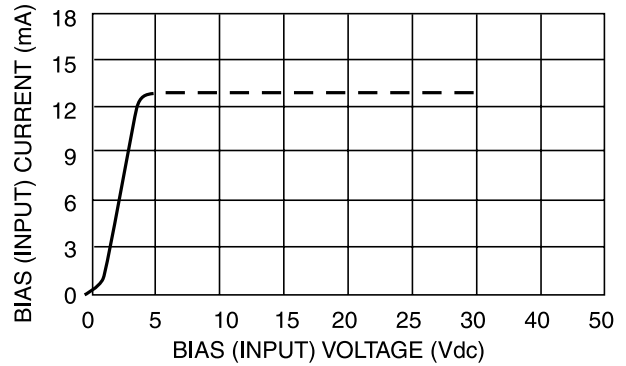

**INPUT CURRENT VS VOLTAGE
FIGURE 2**

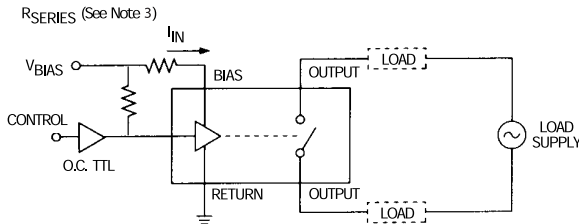

(A) OPEN COLLECTOR TTL DRIVE INPUT CONFIGURATION

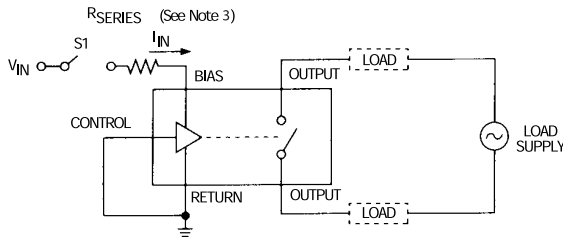

(B) DIRECT DRIVE INPUT CONFIGURATION

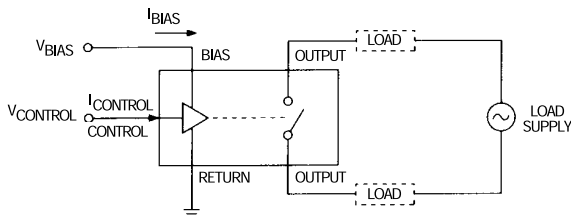

(C) BUFFERED INPUT CONFIGURATION

**WIRING CONFIGURATIONS
FIGURE 1 (SEE NOTE 2)**

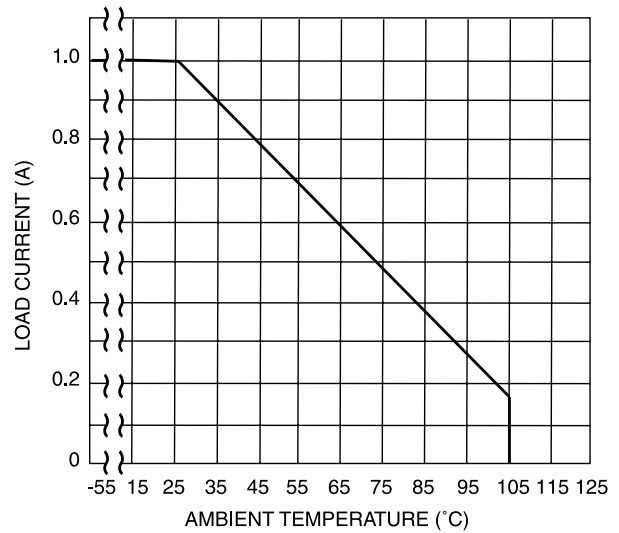

**LOAD CURRENT DERATING CURVE
FIGURE 3**

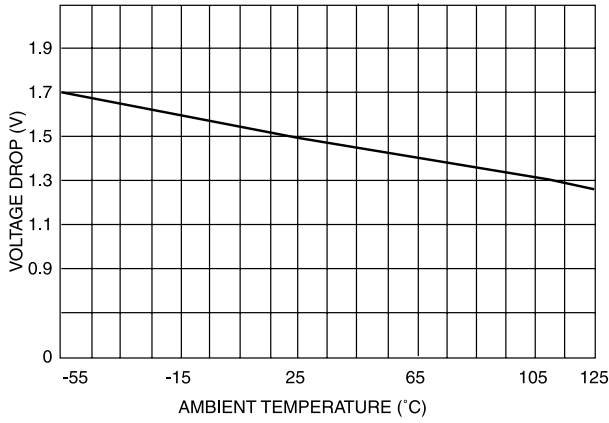

MAXIMUM VOLTAGE DROP VS AMBIENT TEMPERATURE AT $I_{L RATED}$

FIGURE 4

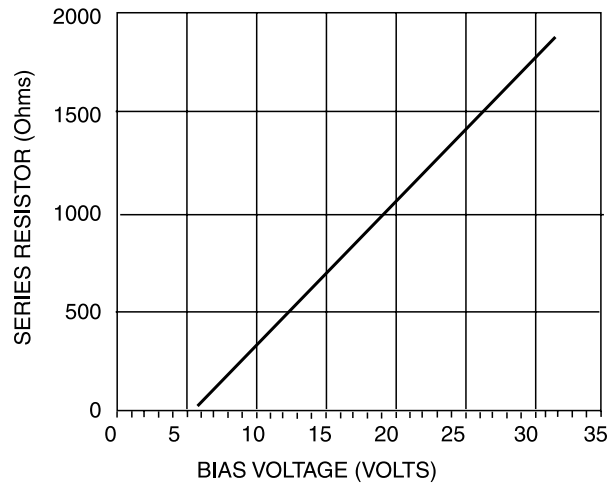

SERIES LIMIT BIAS RESISTOR VS BIAS VOLTAGE

FIGURE 5 (SEE NOTE 3)

NOTES:

1. To increase the dV/dt characteristic to $200V/\mu s$, use an RC snubber across the output terminals with $R = 100$ and $C = 0.01 \mu F$.
2. Control input is compatible with CMOS or open collector TTL (with pull up resistor).
3. For bias voltages above 6V, a series resistor is required. Use a standard resistor value equal to or less than the value found from Figure 5.
4. Output may temporarily lose blocking capability during and after a surge, until T_j falls below maximum.
5. Input transition should be ≤ 1 msec duration and input drive should be "bounceless contact" type.
6. Unless otherwise noted, the input voltage for functional tests shall be 5 Vdc.