

KONNEKT Auto X7R, Ceramic, 9.4 uF, 10%, 50 VDC, X7R

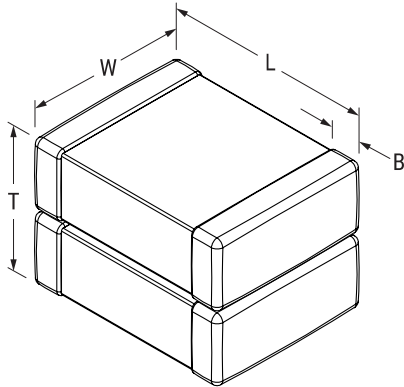

Dimensions	
L	4.5mm +/-0.4mm
W	3.2mm +/-0.3mm
T	3.3mm +/-0.4mm
B	0.7mm +/-0.35mm

Packaging Specifications	
Packaging:	T&R, 180mm, Plastic Tape
Packaging Quantity:	500

General Information	
Series:	KONNEKT Auto X7R
Style:	KONNEKT
Description:	SMD, MLCC, KONNEKT, Ultra-Stable, Class II
Features:	High Density Packaging
RoHS:	Yes
Termination:	Flexible Termination
Qualifications:	AEC-Q200
AEC-Q200:	Yes
Component Weight:	250 mg
Chip Size:	1812-2
Shelf Life:	78 Weeks
MSL:	1

Specifications	
Capacitance:	9.4 uF
Measurement Condition:	120 Hz 0.5Vrms
Capacitance Tolerance:	10%
Voltage DC:	50 VDC
Dielectric Withstanding Voltage:	125 VDC
Temperature Range:	-55/+125°C
Temperature Coefficient:	X7R
Capacitance Change with Reference to +25°C and 0 VDC Applied (TCC):	15%, 120Hz 0.5Vrms
Dissipation Factor:	2.5% 120 Hz 0.5Vrms
Aging Rate:	3% Loss/Decade Hour
Insulation Resistance:	53 MOhms

Statements of suitability for certain applications are based on our knowledge of typical operating conditions for such applications, but are not intended to constitute - and we specifically disclaim - any warranty concerning suitability for a specific customer application or use. This Information is intended for use only by customers who have the requisite experience and capability to determine the correct products for their application. Any technical advice inferred from this Information or otherwise provided by us with reference to the use of our products is given gratis, and we assume no obligation or liability for the advice given or results obtained.