

Surface Mount Multilayer Ceramic Chip Capacitors (SMD MLCCs)  
**High Voltage X7R Dielectric, 500 – 3,000 VDC**  
**(Commercial & Automotive Grade)**

**Overview**

KEMET’s high voltage surface mount MLCCs in X7R Dielectric feature a 125°C maximum operating temperature and are considered “temperature stable.” The Electronics Industries Alliance (EIA) characterizes X7R dielectric as a Class II material. Components of this classification are fixed, ceramic dielectric capacitors suited for bypass and decoupling applications or for frequency discriminating circuits where Q and stability of capacitance characteristics are not critical. X7R exhibits a predictable change in capacitance with respect to time and voltage and boasts a minimal change in capacitance with reference to ambient temperature. Capacitance change is limited to ±15% from -55°C to +125°C.

Available in a variety of case sizes and industry leading CV values (capacitance/voltage), these devices exhibit low leakage current and low ESR at high frequencies. Conventional uses include both snubbers and filters in applications such as switching power supplies and lighting ballasts. Their exceptional

performance at high frequencies has made high voltage MLCC's the preferred dielectric choice of design engineers worldwide. In addition to their use in power supplies, these capacitors are widely used in industries related to automotive (hybrid), telecommunications, medical, military, aerospace, semiconductors and test/diagnostic equipment.

Automotive Grade is available for applications requiring proven, reliable performance in harsh environments. Whether under-hood or in-cabin, these capacitors are designed for mission and safety critical automotive circuits. Stricter testing protocol and inspection criteria have been established for automotive grade products in recognition of potentially harsh environmental conditions. KEMET automotive grade series capacitors meet the demanding Automotive Electronics Council's AEC-Q200 qualification requirements.

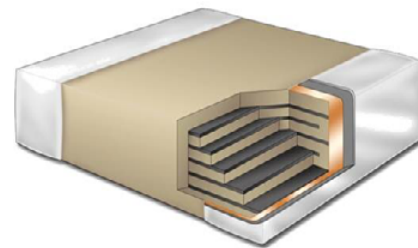

**Ordering Information**

C	1210	C	154	K	C	R	A	C	TU
Ceramic	Case Size (L" x W")	Specification/ Series	Capacitance Code (pF)	Capacitance Tolerance	Voltage	Dielectric	Failure Rate/ Design	Termination Finish <sup>1</sup>	Packaging/Grade (C-Spec) <sup>2</sup>
	0805 1206 1210 1808 1812 1825 2220 2225	C = Standard	2 Significant Digits + Number of Zeros	J = ±5% K = ±10% M = ±20%	C = 500 V B = 630 V D = 1,000 V F = 1,500 V G = 2,000 V Z = 2,500 V H = 3,000 V	R = X7R	A = N/A	C = 100% Matte Sn L = SnPb (5% minimum)	Blank = Bulk TU = 7" Reel Unmarked TM = 7" Reel Marked AUTO = Automotive Grade 7" Reel Unmarked

<sup>1</sup> Additional termination finish options may be available. Contact KEMET for details.

<sup>1,2</sup> SnPb termination finish option is not available on Automotive Grade product.

<sup>2</sup> Additional reeling or packaging options may be available. Contact KEMET for details.

## Dimensions – Millimeters (Inches)

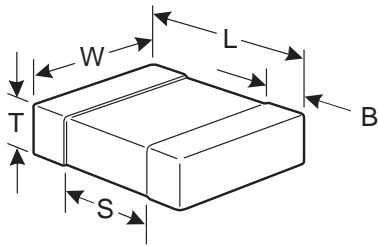

EIA Size Code	Metric Size Code	L Length	W Width	T Thickness	B Bandwidth	S Separation Minimum	Mounting Technique
0805	2012	2.00 (.079) ± 0.20 (.008)	1.25 (.049) ± 0.20 (.008)	See Table 2 for Thickness	0.50 (0.02) ± 0.25 (.010)	0.75 (.030)	Solder Wave or Solder Reflow
1206	3216	3.20 (.126) ± 0.20 (.008)	1.60 (.063) ± 0.20 (.008)		0.50 (0.02) ± 0.25 (.010)	N/A	
1210	3225	3.20 (.126) ± 0.20 (.008)	2.50 (.098) ± 0.20 (.008)		0.50 (0.02) ± 0.25 (.010)		Solder Reflow Only
1808	4520	4.70 (.185) ± 0.50 (.020)	2.00 (.079) ± 0.20 (.008)		0.60 (.024) ± 0.35 (.014)		
1812	4532	4.50 (.177) ± 0.30 (.012)	3.20 (.126) ± 0.30 (.012)		0.60 (.024) ± 0.35 (.014)		
1825	4564	4.50 (.177) ± 0.30 (.012)	6.40 (.252) ± 0.40 (.016)		0.60 (.024) ± 0.35 (.014)		
2220	5650	5.70 (.224) ± 0.40 (.016)	5.00 (.197) ± 0.40 (.016)		0.60 (.024) ± 0.35 (.014)		
2225	5664	5.60 (.220) ± 0.40 (.016)	6.40 (.248) ± 0.40 (.016)		0.60 (.024) ± 0.35 (.014)		

## Benefits

- -55°C to +125°C operating temperature range
- Industry-leading CV values
- Exceptional performance at high frequencies
- Pb-Free and RoHS Compliant
- EIA 0805, 1206, 1210, 1808, 1812, 1825, 2220, and 2225 case sizes
- DC voltage ratings of 500 V, 630 V, 1 KV, 1.5 KV, 2 KV, 2.5 KV, and 3 KV
- Capacitance offerings ranging from 10 pF to 0.33 µF
- Available capacitance tolerances of ±5%, ±10%, and ±20%
- Low ESR and ESL
- Non-polar device, minimizing installation concerns
- Commercial and Automotive (AEC-Q200) grades available
- 100% pure matte tin-plated termination finish allowing for excellent solderability
- SnPb plated termination finish option available upon request (5% minimum)

## Applications

Typical applications include switch mode power supplies (input filters, resonators, tank circuits, snubber circuits, output filters), high voltage coupling and DC blocking, lighting ballasts, voltage multiplier circuits, DC/DC converters and coupling capacitors in Ćuk converters. Markets include power supply, LCD fluorescent backlight ballasts, HID lighting, telecom equipment, industrial and medical equipment/control, LAN/WAN interface, analog and digital modems, and automotive (electric and hybrid vehicles, charging stations and lighting) applications.

## Application Note

X7R dielectric is not recommended for AC line filtering or pulse applications.

## Qualification/Certification

Commercial Grade products are subject to internal qualification. Details regarding test methods and conditions are referenced in Table 4, Performance & Reliability.

Automotive Grade products meet or exceed the requirements outlined by the Automotive Electronics Council. Details regarding test methods and conditions are referenced in document AEC-Q200, Stress Test Qualification for Passive Components. For additional information regarding the Automotive Electronics Council and AEC-Q200, please visit their website at [www.aecouncil.com](http://www.aecouncil.com).

## Environmental Compliance

Pb-Free and RoHS Compliant (excluding SnPb termination finish option).



RoHS Compliant

## Electrical Parameters/Characteristics

Item	Parameters/Characteristics
Operating Temperature Range	-55°C to +125°C
Capacitance Change with Reference to +25°C and 0 VDC Applied (TCC)	±15%
Aging Rate (Maximum % Capacitance Loss/Decade Hour)	3.0%
Dielectric Withstanding Voltage (DWV)	150% of rated voltage for voltage rating of < 1,000 V 120% of rated voltage for voltage rating of ≥ 1,000 V (5 ±1 second and charge/discharge not exceeding 50 mA)
Dissipation Factor (DF) Maximum Limit @ 25°C	2.5%
Insulation Resistance (IR) Limit @ 25°C	See Insulation Resistance Limit Table (500 VDC applied for 120 ±5 seconds @ 25°C)

Regarding aging rate: Capacitance measurements (including tolerance) are indexed to a referee time of 1,000 hours.

To obtain IR limit, divide  $M\Omega \cdot \mu F$  value by the capacitance and compare to  $G\Omega$  limit. Select the lower of the two limits.

Capacitance and dissipation factor (DF) measured under the following conditions:

1 kHz ±50 Hz and 1.0 ±0.2 Vrms if capacitance ≤ 10 μF

120 Hz ±10 Hz and 0.5 ±0.1 Vrms if capacitance > 10 μF

Note: When measuring capacitance it is important to ensure the set voltage level is held constant. The HP4284 and Agilent E4980 have a feature known as Automatic Level Control (ALC). The ALC feature should be switched to "ON."

## Post Environmental Limits

High Temperature Life, Biased Humidity, Moisture Resistance					
Dielectric	Rated DC Voltage	Capacitance Value	Dissipation Factor (Maximum %)	Capacitance Shift	Insulation Resistance
X7R	> 25	All	3.0	±20%	10% of Initial Limit
	16/25		5.0		
	< 16		7.5		

## Insulation Resistance Limit Table (X7R Dielectric)

EIA Case Size	1,000 Megohm Microfarads or 100 GΩ	100 Megohm Microfarads or 10 GΩ
0805	< 0.0039 μF	≥ 0.0039 μF
1206	< 0.012 μF	≥ 0.012 μF
1210	< 0.033 μF	≥ 0.033 μF
1808	< 0.018 μF	≥ 0.018 μF
1812	< 0.027 μF	≥ 0.027 μF
≥ 1825	All	All

Table 1A – Capacitance Range/Selection Waterfall (0805 – 1812 Case Sizes)

Capacitance	Cap Code	Series			C0805					C1206					C1210					C1808								C1812											
		Voltage Code			C	B	D	C	B	D	F	G	C	B	D	F	G	C	B	D	F	G	Z	H	C	B	D	F	G	Z	H								
		Voltage DC			500	630	1000	500	630	1000	1500	2000	500	630	1000	1500	2000	500	630	1000	1500	2000	2500	3000	500	630	1000	1500	2000	2500	3000								
		Capacitance Tolerance			Product Availability and Chip Thickness Codes - See Table 2 for Chip Thickness Dimensions																																		
10 pF	100	J	K	M	DG	DG	DG	EG	EG	EG	EG	EG	FM	FM	FM	FM	FM	LB	LB	LB	LB	LB	LB	LB	LB	LB	LB	LB	LB	LB	GK	GK	GK	GK	GK	GK	GK	GK	
11 pF	110	J	K	M	DG	DG	DG	EG	EG	EG	EG	EG	FM	FM	FM	FM	FM	LB	LB	LB	LB	LB	LB	LB	LB	LB	LB	LB	LB	LB	LB	GK	GK	GK	GK	GK	GK	GK	GK
12 pF	120	J	K	M	DG	DG	DG	EG	EG	EG	EG	EG	FM	FM	FM	FM	FM	LB	LB	LB	LB	LB	LB	LB	LB	LB	LB	LB	LB	LB	GK	GK	GK	GK	GK	GK	GK	GK	
13 pF	130	J	K	M	DG	DG	DG	EG	EG	EG	EG	EG	FM	FM	FM	FM	FM	LB	LB	LB	LB	LB	LB	LB	LB	LB	LB	LB	LB	LB	GK	GK	GK	GK	GK	GK	GK	GK	
15 pF	150	J	K	M	DG	DG	DG	EG	EG	EG	EG	EG	FM	FM	FM	FM	FM	LB	LB	LB	LB	LB	LB	LB	LB	LB	LB	LB	LB	LB	GK	GK	GK	GK	GK	GK	GK	GK	
16 pF	160	J	K	M	DG	DG	DG	EG	EG	EG	EG	EG	FM	FM	FM	FM	FM	LB	LB	LB	LB	LB	LB	LB	LB	LB	LB	LB	LB	LB	GK	GK	GK	GK	GK	GK	GK	GK	
18 pF	180	J	K	M	DG	DG	DG	EG	EG	EG	EG	EG	FM	FM	FM	FM	FM	LB	LB	LB	LB	LB	LB	LB	LB	LB	LB	LB	LB	LB	GK	GK	GK	GK	GK	GK	GK	GK	
20 pF	200	J	K	M	DG	DG	DG	EG	EG	EG	EG	EG	FM	FM	FM	FM	FM	LB	LB	LB	LB	LB	LB	LB	LB	LB	LB	LB	LB	LB	GK	GK	GK	GK	GK	GK	GK	GK	
22 pF	220	J	K	M	DG	DG	DG	EG	EG	EG	EG	EG	FM	FM	FM	FM	FM	LB	LB	LB	LB	LB	LB	LB	LB	LB	LB	LB	LB	LB	GK	GK	GK	GK	GK	GK	GK	GK	
24 pF	240	J	K	M	DG	DG	DG	EG	EG	EG	EG	EG	FM	FM	FM	FM	FM	LB	LB	LB	LB	LB	LB	LB	LB	LB	LB	LB	LB	LB	GK	GK	GK	GK	GK	GK	GK	GK	
27 pF	270	J	K	M	DG	DG	DG	EG	EG	EG	EG	EG	FM	FM	FM	FM	FM	LB	LB	LB	LB	LB	LB	LB	LB	LB	LB	LB	LB	LB	GK	GK	GK	GK	GK	GK	GK	GK	
30 pF	300	J	K	M	DG	DG	DG	EG	EG	EG	EG	EG	FM	FM	FM	FM	FM	LB	LB	LB	LB	LB	LB	LB	LB	LB	LB	LB	LB	LB	GK	GK	GK	GK	GK	GK	GK	GK	
33 pF	330	J	K	M	DG	DG	DG	EG	EG	EG	EG	EG	FM	FM	FM	FM	FM	LB	LB	LB	LB	LB	LB	LB	LB	LB	LB	LB	LB	LB	GK	GK	GK	GK	GK	GK	GK	GK	
36 pF	360	J	K	M	DG	DG	DG	EG	EG	EG	EG	EG	FM	FM	FM	FM	FM	LB	LB	LB	LB	LB	LB	LB	LB	LB	LB	LB	LB	LB	GK	GK	GK	GK	GK	GK	GK	GK	
39 pF	390	J	K	M	DG	DG	DG	EG	EG	EG	EG	EG	FM	FM	FM	FM	FM	LB	LB	LB	LB	LB	LB	LB	LB	LB	LB	LB	LB	LB	GK	GK	GK	GK	GK	GK	GK	GK	
43 pF	430	J	K	M	DG	DG	DG	EG	EG	EG	EG	EG	FM	FM	FM	FM	FM	LB	LB	LB	LB	LB	LB	LB	LB	LB	LB	LB	LB	LB	GK	GK	GK	GK	GK	GK	GK	GK	
47 pF	470	J	K	M	DG	DG	DG	EG	EG	EG	EG	EG	FM	FM	FM	FM	FM	LB	LB	LB	LB	LB	LB	LB	LB	LB	LB	LB	LB	LB	GK	GK	GK	GK	GK	GK	GK	GK	
51 pF	510	J	K	M	DG	DG	DG	EF	EF	EF	EG	EG	FM	FM	FM	FM	FM	LB	LB	LB	LB	LB	LB	LB	LB	LB	LB	LB	LB	LB	GK	GK	GK	GK	GK	GK	GK	GK	
56 pF	560	J	K	M	DG	DG	DG	EF	EF	EF	EG	EG	FM	FM	FM	FM	FM	LB	LB	LB	LB	LB	LB	LB	LB	LB	LB	LB	LB	LB	GK	GK	GK	GK	GK	GK	GK	GK	
62 pF	620	J	K	M	DG	DG	DG	EF	EF	EF	EG	EG	FM	FM	FM	FM	FM	LB	LB	LB	LB	LB	LB	LB	LB	LB	LB	LB	LB	LB	GK	GK	GK	GK	GK	GK	GK	GK	
68 pF	680	J	K	M	DG	DG	DG	EF	EF	EF	EG	EG	FM	FM	FM	FM	FM	LB	LB	LB	LB	LB	LB	LB	LB	LB	LB	LB	LB	LB	GK	GK	GK	GK	GK	GK	GK	GK	
75 pF	750	J	K	M	DG	DG	DG	EF	EF	EF	EG	EG	FM	FM	FM	FM	FM	LB	LB	LB	LB	LB	LB	LB	LB	LB	LB	LB	LB	LB	GK	GK	GK	GK	GK	GK	GK	GK	
82 pF	820	J	K	M	DG	DG	DG	EF	EF	EF	EG	EG	FM	FM	FM	FM	FM	LB	LB	LB	LB	LB	LB	LB	LB	LB	LB	LB	LB	LB	GK	GK	GK	GK	GK	GK	GK	GK	
91 pF	910	J	K	M	DG	DG	DG	EF	EF	EF	EG	EG	FM	FM	FM	FM	FM	LB	LB	LB	LB	LB	LB	LB	LB	LB	LB	LB	LB	LB	GK	GK	GK	GK	GK	GK	GK	GK	
100 pF	101	J	K	M	DG	DG	DG	EF	EF	EF	EG	EG	FM	FM	FM	FM	FM	LB	LB	LB	LB	LB	LB	LB	LB	LB	LB	LC	LB	GK	GK	GK	GK	GK	GK	GK	GK		
110 pF	111	J	K	M	DG	DG	DG	EF	EF	EF	EG	EG	FM	FM	FM	FM	FM	LB	LB	LB	LB	LB	LB	LB	LB	LB	LC	LB	GK	GK	GK	GK	GK	GK	GK	GK			
120 pF	121	J	K	M	DG	DG	DG	EF	EF	EF	EG	EG	FM	FM	FM	FM	FM	LA	LA	LA	LA	LA	LA	LB	LC	LB	GK	GK	GK	GK	GK	GK	GK	GK	GK	GK	GK		
130 pF	131	J	K	M	DG	DG	DG	EF	EF	EF	EG	EG	FG	FG	FG	FM	FM	LA	LA	LA	LA	LA	LB	LC	LB	GK	GK	GK	GK	GK	GK	GK	GK	GK	GK	GK	GK		
150 pF	151	J	K	M	DG	DG	DG	EF	EF	EF	EG	EG	FG	FG	FG	FM	FM	LA	LA	LA	LA	LA	LB	LC	LB	GK	GK	GK	GK	GK	GK	GK	GK	GK	GK	GK	GK	GK	
180 pF	181	J	K	M	DG	DG	DG	EF	EF	EF	EG	EG	FG	FG	FG	FM	FM	LA	LA	LA	LA	LA	LB	LC	LB	GK	GK	GK	GK	GK	GK	GK	GK	GK	GK	GK	GK	GK	
220 pF	221	J	K	M	DG	DG	DG	EF	EG	EG	EG	EG	FG	FG	FG	FM	FM	LA	LA	LA	LA	LA	LB	LC	LB	GK	GK	GK	GK	GK	GK	GK	GK	GK	GK	GK	GK	GK	
270 pF	271	J	K	M	DG	DG	DG	EF	EG	EG	EG	EG	FG	FG	FG	FK	FK	LA	LA	LA	LA	LB	LC	LC	GH	GH	GH	GH	GH	GH	GH	GH	GH	GH	GH	GH	GH	GH	
330 pF	331	J	K	M	DG	DG	DG	EF	EG	EG	EG	EG	FG	FG	FG	FK	FK	LA	LA	LA	LA	LB	LC	LC	GH	GH	GH	GH	GH	GH	GH	GH	GH	GH	GH	GH	GH	GH	
390 pF	391	J	K	M	DG	DG	DG	EG	EG	EG	EG	EG	FG	FG	FG	FK	FS	LA	LA	LA	LA	LB	LB	LC	GK	GK	GK	GK	GK	GK	GK	GK	GK	GK	GK	GK	GK	GK	GK
470 pF	471	J	K	M	DG	DG	DG	EG	EG	EG	EF	EG	FG	FM	FM	FS	FS	LA	LA	LB	LC	LB	LC	GK	GK	GK	GK	GK	GK	GK	GK	GK	GK	GK	GK	GK	GK	GK	
560 pF	561	J	K	M	DG	DG	DG	EG	EG	EG	EF	EG	FG	FM	FM	FS	FL	LA	LB	LB	LC	LB	LC	GH	GH	GH	GH	GH	GH	GH	GH	GH	GH	GH	GH	GH	GH	GH	
680 pF	681	J	K	M	DG	DG	DG	EG	EG	EG	EF	EG	FG	FM	FM	FS	FL	LA	LB	LB	LA	LB	LC	LC	GH	GH	GH	GH	GH	GH	GH	GH	GH	GH	GH	GH	GH	GH	GH
820 pF	821	J	K	M	DG	DG	DG	EG	EF	EF	EF	EG	FG	FM	FM	FL	FL	LB	LB	LB	LA	LB	LC	LC	GH	GH	GH	GH	GH	GH	GH	GH	GH	GH	GH	GH	GH	GH	GH
1,000 pF	102	J	K	M	DG	DG	DG	EG	EF	EF	EF	EG	FM	FM	FM	FL	FL	LB	LB	LB	LA	LB	LC	LC	GH	GH	GH	GH	GH	GH	GH	GH	GH	GH	GH	GH	GH	GH	
1,200 pF	122	J	K	M	DG	DG	DG	EF	EF	EF	EG	EG	FM	FK	FK	FL	FM	LC	LC	LC	LB	LC	GH	GH	GH	GH	GH	GH	GH	GH	GH	GH	GH	GH	GH	GH	GH	GH	
1,500 pF	152	J	K	M	DG	DG	DG	EF	EF	EF	EG	EG	FK	FS	FS	FL	FM	LC	LC	LC	LB	LC	GH	GH	GH	GH	GH	GH	GH	GH	GH	GH	GH	GH	GH	GH	GH	GH	
1,800 pF	182	J	K	M	DG	DG	DG	EF	EF	EF	EG	EG	FK	FS	FS	FL	FM	LC	LC	LC	LB	LC	GH	GH	GH	GH	GH	GH	GH	GH	GH	GH	GH	GH	GH	GH	GH	GH	
2,000 pF	202	J	K	M	DG	DG	DG	EF	EF	EF	EG	EG	FK	FL	FL	FL	FM	LC	LA	LA	LB	LC	GH	GH	GH	GH	GH	GH	GH	GH	GH	GH	GH	GH	GH	GH	GH	GH	
2,200 pF	222	J	K	M	DG	DG	DG	EF	EF	EF	EG	EG	FK	FL	FL	FL	FM	LC	LA	LA	LB	LC	GH	GH	GH	GH	GH	GH	GH	GH	GH	GH	GH	GH	GH	GH	GH	GH	GH
2,700 pF	272	J	K	M	DG	DG	DG	EF	EF	EF	EG	EG	FS	FL	FL	FL	FM	LC	LA	LA	LB	LC	GH	GH	GH	GH	GH	GH	GH	GH	GH	GH	GH	GH	GH	GH	GH	GH	
3,300 pF	332	J	K	M	DG	DG	DG	EF	EF	EF	EG	EG	FS	FL	FL	FL	FM	LA	LA	LA	LB	LC	GH	GH	GH	GH	GH	GH	GH	GH	GH	GH	GH	GH	GH	GH	GH	GH	
3,900 pF	392	J	K	M	DG	DG	DG	EF	EF	EF	EG	EG	FL	FL	FL	FL	FK	LA	LA	LA	LB	LC	GH	GH	GH	GH	GH	GH	GH	GH	GH	GH	GH	GH	GH	GH	GH	GH	GH
4,700 pF	472	J	K	M	DG	DG	DG	EF</																															

**Table 1A – Capacitance Range/Selection Waterfall (0805 – 1812 Case Sizes) cont'd**

Capacitance	Cap Code	Series	C0805					C1206					C1210					C1808						C1812											
		Voltage Code			C	B	D	C	B	D	F	G	C	B	D	F	G	C	B	D	F	G	Z	H	C	B	D	F	G	Z	H				
		Voltage DC			500	630	1000	500	630	1000	1500	2000	500	630	1000	1500	2000	500	630	1000	1500	2000	2500	3000	500	630	1000	1500	2000	2500	3000				
		<b>Product Availability and Chip Thickness Codes - See Table 2 for Chip Thickness Dimensions</b>																																	
15,000 pF	153	J	K	M				EG	EJ	EJ						FL	FL	FL							LA	LC	LC						GH	GK	GK
18,000 pF	183	J	K	M				EJ	EJ	EJ						FL	FL	FL							LA	LE	LE						GH	GK	GK
22,000 pF	223	J	K	M				EJ	EJ	EJ						FL	FM	FM							LA	LE	LE						GH	GK	GK
27,000 pF	273	J	K	M				EJ	EJ							FM	FK	FK							LA	LA	LA						GH	GB	GB
33,000 pF	333	J	K	M				EJ	EJ							FM	FG	FH							LC	LA	LA						GH	GB	GB
39,000 pF	393	J	K	M				EJ								FK	FG	FH							LC	LA	LA						GH	GB	GB
47,000 pF	473	J	K	M				EJ								FK	FH	FK							LC	LA	LB						GH	GB	GB
56,000 pF	563	J	K	M				EJ								FG	FH	FK							LC	LA	LB						GH	GB	GE
62,000 pF	623	J	K	M				EJ								FG	FK	UD							LA	LA	LC						GK	GB	GE
68,000 pF	683	J	K	M				EJ								FG	FK	UD							LA	LA	LC						GE	GE	GE
82,000 pF	823	J	K	M												FH	FK								LA	LC							GB	GE	GK
0.10 μF	104	J	K	M												FK	UD								LA	LC							GB	GH	GJ
0.12 μF	124	J	K	M												FK									LA								GE	GK	
0.15 μF	154	J	K	M												FK									LB								GE	GN	
0.18 μF	184	J	K	M																													GF		
0.22 μF	224	J	K	M																													GJ		
0.27 μF	274	J	K	M																													GL		
0.33 μF	334	J	K	M																													GS		
Capacitance	Cap Code	Voltage DC			500	630	1000	500	630	1000	1500	2000	500	630	1000	1500	2000	500	630	1000	1500	2000	2500	3000	500	630	1000	1500	2000	2500	3000				
		Voltage Code			C	B	D	C	B	D	F	G	C	B	D	F	G	C	B	D	F	G	Z	H	C	B	D	F	G	Z	H				
		Series			C0805					C1206					C1210					C1808						C1812									

**Table 1B – Capacitance Range/Selection Waterfall (1825–2225 Case Sizes)**

Capacitance	Cap Code	Series	C1825							C2220							C2225											
		Voltage Code			C	B	D	F	G	Z	H	C	B	D	F	G	Z	H	C	B	D	F	G	Z	H			
		Voltage DC			500	630	1000	1500	2000	2500	3000	500	630	1000	1500	2000	2500	3000	500	630	1000	1500	2000	2500	3000			
		<b>Product Availability and Chip Thickness Codes – See Table 2 for Chip Thickness Dimensions</b>																										
100 pF	101	J	K	M	HG	HG	HG	HG	HG	HG	JP	JP	JP	JP	JP	JP	JP	KF	KF	KF	KF	KF	KF	KF	KF	KF		
110 pF	111	J	K	M	HG	HG	HG	HG	HG	HG	JP	JP	JP	JP	JP	JP	JP	KF	KF	KF	KF	KF	KF	KF	KF	KF		
120 pF	121	J	K	M	HG	HG	HG	HG	HG	HG	JP	JP	JP	JP	JP	JP	JP	KF	KF	KF	KF	KF	KF	KF	KF	KF		
130 pF	131	J	K	M	HG	HG	HG	HG	HG	HG	JP	JP	JP	JP	JP	JP	JP	KF	KF	KF	KF	KF	KF	KF	KF	KF		
150 pF	151	J	K	M	HG	HG	HG	HG	HG	HG	JP	JP	JP	JP	JP	JP	JP	KF	KF	KF	KF	KF	KF	KF	KF	KF		
180 pF	181	J	K	M	HG	HG	HG	HG	HG	HG	JP	JP	JP	JP	JP	JP	JP	KF	KF	KF	KF	KF	KF	KF	KF	KF		
220 pF	221	J	K	M	HE	HE	HE	HE	HE	HE	JP	JP	JP	JP	JP	JP	JP	KF	KF	KF	KF	KF	KF	KF	KF	KF		
270 pF	271	J	K	M	HE	HE	HE	HE	HE	HG	JP	JP	JP	JP	JP	JP	JP	KE	KE	KE	KE	KE	KE	KE	KE	KF		
330 pF	331	J	K	M							JE	JE	JE	JE	JE	JP	JP	KE	KE	KE	KE	KE	KE	KE	KE	KF		
390 pF	391	J	K	M							JE	JE	JE	JE	JE	JP	JP	KE	KE	KE	KE	KE	KE	KE	KE	KF		
470 pF	471	J	K	M	HG	HG	HG	HG	HG	HG	JE	JE	JE	JE	JE	JP	JP	KF	KF	KF	KF	KF	KE	KE	KF			
560 pF	561	J	K	M	HG	HG	HG	HG	HG	HG	JP	JP	JP	JP	JP	JP	JP	KF	KF	KF	KF	KF	KE	KE	KF			
680 pF	681	J	K	M	HG	HG	HG	HG	HG	HG	JE	JE	JE	JP	JP	JP	JP	KF	KF	KF	KF	KF	KE	KE	KF			
820 pF	821	J	K	M	HG	HG	HG	HG	HG	HG	JE	JE	JE	JP	JP	JP	JP	KE	KE	KE	KE	KF	KE	KE	KF			
1,000 pF	102	J	K	M	HG	HG	HG	HG	HG	HG	JE	JE	JP	JP	JP	JP	JP	KE	KE	KE	KE	KF	KE	KE	KF			
1,200 pF	122	J	K	M	HG	HG	HG	HG	HG	HG	JE	JP	JP	JP	JP	JP	JP	KE	KE	KE	KF	KF	KF	KF	KF			
1,500 pF	152	J	K	M	HG	HG	HG	HG	HG	HG	JE	JP	JP	JP	JP	JP	JP	KE	KE	KE	KF	KF	KF	KF	KF			
1,800 pF	182	J	K	M	HE	HE	HE	HE	HG	HG	JE	JP	JP	JP	JP	JP	JP	KE	KE	KE	KF	KF	KF	KF	KF			
Capacitance	Cap Code	Voltage DC			500	630	1000	1500	2000	2500	3000	500	630	1000	1500	2000	2500	3000	500	630	1000	1500	2000	2500	3000			
		Voltage Code			C	B	D	F	G	Z	H	C	B	D	F	G	Z	H	C	B	D	F	G	Z	H			
		Series			C1825							C2220							C2225									

UD = Under development

KEMET reserves the right to substitute product with an improved temperature characteristic, tighter capacitance tolerance and/or higher voltage capability within the same form factor (configuration and dimensions).

**Table 1B – Capacitance Range/Selection Waterfall (1825 – 2225 Case Sizes) cont'd**

Capacitance	Cap Code	Series			C1825								C2220								C2225							
		Voltage Code			C	B	D	F	G	Z	H	C	B	D	F	G	Z	H	C	B	D	F	G	Z	H			
		Voltage DC			500	630	1000	1500	2000	2500	3000	500	630	1000	1500	2000	2500	3000	500	630	1000	1500	2000	2500	3000			
		Capacitance Tolerance			Product Availability and Chip Thickness Codes – See Table 2 for Chip Thickness Dimensions																							
2,000 pF	202	J	K	M	HE	HE	HE	HE	HE	HG	HG	JE	JP	JP	JE	JE	JP	JP	KE	KE	KE	KF	KF	KF	KF			
2,200 pF	222	J	K	M	HE	HE	HE	HE	HE	HG	HG	JE	JP	JP	JE	JE	JP	JP	KF	KE	KE	KF	KF	KF	KF			
2,700 pF	272	J	K	M	HE	HE	HE	HE	HE	HG		JP	JP	JP	JE	JE	JP	JP	KE	KE	KE	KE	KE	KF				
3,300 pF	332	J	K	M	HE	HE	HE	HE	HE	HG		JP	JP	JP	JE	JE	JP		KE	KE	KE	KE	KE	KF				
3,900 pF	392	J	K	M	HE	HE	HE	HE	HE			JP	JP	JP	JE	JE	JP		KE	KF	KE	KE	KE	KF				
4,700 pF	472	J	K	M	HE	HE	HE	HE	HE			JP	JP	JP	JE	JP			KE	KF	KF	KE	KE	KF				
5,600 pF	562	J	K	M	HE	HE	HE	HE	HE			JP	JP	JP	JE	JP			KE	KF	KF	KE	KE	KF				
6,800 pF	682	J	K	M	HE	HE	HE	HE	HE			JP	JE	JE	JE	JP			KE	KF	KF	KE	KF					
8,200 pF	822	J	K	M	HE	HE	HE	HE	HE			JP	JE	JE	JE	JP			KF	KE	KE	KE	KF					
10,000 pF	103	J	K	M	HE	HE	HE	HE				JE	JE	JE	JE				KF	KE	KE	KE	KF					
12,000 pF	123	J	K	M	HE	HE	HE	HG				JE	JP	JP	JP				KE	KE	KE	KE	KF					
15,000 pF	153	J	K	M	HE	HE	HE	HG				JE	JP	JP	JP				KE	KE	KE	KE						
18,000 pF	183	J	K	M	HE	HE	HE	HG				JE	JP	JP	JP				KE	KE	KE	KE						
22,000 pF	223	J	K	M	HE	HG	HG	HG				JE	JP	JP	JP				KE	KF	KF	KF						
27,000 pF	273	J	K	M	HE	HG	HG	HG				JE	JP	JP	JP				KE	KF	KF	KF						
33,000 pF	333	J	K	M	HE	HG	HG					JE	JP	JP	JP				KE	KF	KF	KF						
39,000 pF	393	J	K	M	HE	HG	HG					JE	JP	JP					KE	KF	KF	KF						
47,000 pF	473	J	K	M	HE	HG	HG					JE	JP	JP					KE	KF	KF	KF						
56,000 pF	563	J	K	M	HE							JE							KE	KF	KF							
62,000 pF	623	J	K	M	HG							JE							KE	KF	KF							
68,000 pF	683	J	K	M	HG							JE							KE	KF	KF							
82,000 pF	823	J	K	M	HG							JE							KE									
0.10 µF	104	J	K	M	HG							JE							KE									
0.12 µF	124	J	K	M	HG							JE							KE									
0.15 µF	154	J	K	M	HG							JP							KF									
0.18 µF	184	J	K	M	HG							JP							KF									
0.22 µF	224	J	K	M	HG							JP							KF									
Capacitance	Cap Code	Voltage DC			500	630	1000	1500	2000	2500	3000	500	630	1000	1500	2000	2500	3000	500	630	1000	1500	2000	2500	3000			
		Voltage Code			C	B	D	F	G	Z	H	C	B	D	F	G	Z	H	C	B	D	F	G	Z	H			
		Series			C1825								C2220								C2225							

KEMET reserves the right to substitute product with an improved temperature characteristic, tighter capacitance tolerance and/or higher voltage capability within the same form factor (configuration and dimensions).

**Table 2 – Chip Thickness/Packaging Quantities**

Thickness Code	Case Size	Thickness ± Range (mm)	Paper Quantity		Plastic Quantity	
			7" Reel	13" Reel	7" Reel	13" Reel
DG	0805	1.25 ± 0.15	0	0	2,500	10,000
EF	1206	1.20 ± 0.15	0	0	2,500	10,000
EG	1206	1.60 ± 0.15	0	0	2,000	8,000
EJ	1206	1.70 ± 0.20	0	0	2,000	8,000
FG	1210	1.25 ± 0.15	0	0	2,500	10,000
FL	1210	1.40 ± 0.15	0	0	2,000	8,000
FH	1210	1.55 ± 0.15	0	0	2,000	8,000
FM	1210	1.70 ± 0.20	0	0	2,000	8,000
FK	1210	2.10 ± 0.20	0	0	2,000	8,000
FS	1210	2.50 ± 0.20	0	0	1,000	4,000
LE	1808	1.00 ± 0.10	0	0	2,500	10,000
LA	1808	1.40 ± 0.15	0	0	1,000	4,000
LB	1808	1.60 ± 0.15	0	0	1,000	4,000
LC	1808	2.00 ± 0.15	0	0	1,000	4,000
GB	1812	1.00 ± 0.10	0	0	1,000	4,000
GE	1812	1.30 ± 0.10	0	0	1,000	4,000
GH	1812	1.40 ± 0.15	0	0	1,000	4,000
GF	1812	1.50 ± 0.10	0	0	1,000	4,000
GK	1812	1.60 ± 0.20	0	0	1,000	4,000
GJ	1812	1.70 ± 0.15	0	0	1,000	4,000
GN	1812	1.70 ± 0.20	0	0	1,000	4,000
GL	1812	1.90 ± 0.20	0	0	500	2,000
GS	1812	2.10 ± 0.20	0	0	500	2,000
HE	1825	1.40 ± 0.15	0	0	1,000	4,000
HG	1825	1.60 ± 0.20	0	0	1,000	4,000
JE	2220	1.40 ± 0.15	0	0	1,000	4,000
JP	2220	1.60 ± 0.20	0	0	1,000	4,000
KE	2225	1.40 ± 0.15	0	0	1,000	4,000
KF	2225	1.60 ± 0.20	0	0	1,000	4,000
Thickness Code	Case Size	Thickness ± Range (mm)	7" Reel	13" Reel	7" Reel	13" Reel
			Paper Quantity		Plastic Quantity	

Package quantity based on finished chip thickness specifications.



**Table 3 – Chip Capacitor Land Pattern Design Recommendations per IPC–7351**

EIA Size Code	Metric Size Code	Density Level A: Maximum (Most) Land Protrusion (mm)					Density Level B: Median (Nominal) Land Protrusion (mm)					Density Level C: Minimum (Least) Land Protrusion (mm)				
		C	Y	X	V1	V2	C	Y	X	V1	V2	C	Y	X	V1	V2
0805	2012	1.00	1.35	1.55	4.40	2.60	0.90	1.15	1.45	3.50	2.00	0.80	0.95	1.35	2.80	1.70
1206	3216	1.60	1.65	1.90	5.90	2.90	1.50	1.45	1.80	5.00	2.30	1.40	1.25	1.70	4.30	2.00
1210	3225	1.60	1.65	2.80	5.90	3.80	1.50	1.45	2.70	5.00	3.20	1.40	1.25	2.60	4.30	2.90
1210 <sup>1</sup>	3225	1.50	1.60	2.90	5.60	3.90	1.40	1.40	2.80	4.70	3.30	1.30	1.20	2.70	4.00	3.00
1808	4520	2.25	1.85	2.30	7.40	3.30	2.15	1.65	2.20	6.50	2.70	2.05	1.45	2.10	5.80	2.40
1812	4532	2.10	1.80	3.60	7.00	4.60	2.00	1.60	3.50	6.10	4.00	1.90	1.40	3.40	5.40	3.70
1825	4564	2.15	1.80	6.90	7.10	7.90	2.05	1.60	6.80	6.20	7.30	1.95	1.40	6.70	5.50	7.00
2220	5650	2.85	2.10	5.50	8.80	6.50	2.75	1.90	5.40	7.90	5.90	2.65	1.70	5.30	7.20	5.60
2225	5664	2.85	2.10	6.90	8.80	7.90	2.75	1.90	6.80	7.90	7.30	2.65	1.70	6.70	7.20	7.00

<sup>1</sup> Only for capacitance values  $\geq 22 \mu\text{F}$

**Density Level A:** For low-density product applications. Recommended for wave solder applications and provides a wider process window for reflow solder processes. KEMET only recommends wave soldering of EIA 0603, 0805 and 1206 case sizes.

**Density Level B:** For products with a moderate level of component density. Provides a robust solder attachment condition for reflow solder processes.

**Density Level C:** For high component density product applications. Before adapting the minimum land pattern variations the user should perform qualification testing based on the conditions outlined in IPC Standard 7351 (IPC–7351).

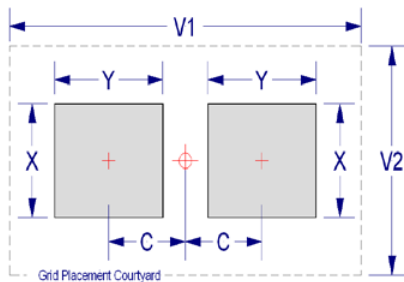

## Soldering Process

Recommended Soldering Technique:

- Solder wave or solder reflow for EIA case sizes 0603, 0805 and 1206
- All other EIA case sizes are limited to solder reflow only

Recommended Soldering Profile:

- KEMET recommends following the guidelines outlined in IPC/JEDEC J–STD–020

**Table 4 – Performance & Reliability: Test Methods and Conditions**

Stress	Reference	Test or Inspection Method
Terminal Strength	JIS-C-6429	Appendix 1, Note: Force of 1.8 kg for 60 seconds.
Board Flex	JIS-C-6429	Appendix 2, Note: Standard termination system – 2.0 mm (minimum) for all except 3 mm for COG. Flexible termination system – 3.0 mm (minimum).
Solderability	J-STD-002	Magnification 50 X. Conditions:
		a) Method B, 4 hours @ 155°C, dry heat @ 235°C
		b) Method B @ 215°C category 3
		c) Method D, category 3 @ 260°C
Temperature Cycling	JESD22 Method JA-104	1,000 cycles (-55°C to +125°C). Measurement at 24 hours +/- 2 hours after test conclusion.
Biased Humidity	MIL-STD-202 Method 103	Load Humidity: 1,000 hours 85°C/85% RH and 200 VDC maximum. Add 100 K ohm resistor. Measurement at 24 hours +/- 2 hours after test conclusion.
		Low Volt Humidity: 1,000 hours 85°C/85% RH and 1.5 V. Add 100 K ohm resistor. Measurement at 24 hours +/- 2 hours after test conclusion.
Moisture Resistance	MIL-STD-202 Method 106	t = 24 hours/cycle. Steps 7a and 7b not required. Unpowered. Measurement at 24 hours +/- 2 hours after test conclusion.
Thermal Shock	MIL-STD-202 Method 107	-55°C/+125°C. Note: Number of cycles required – 300. Maximum transfer time – 20 seconds. Dwell time – 15 minutes. Air – Air.
High Temperature Life	MIL-STD-202 Method 108	1,000 hours at 125°C (85°C for X5R, Z5U and Y5V) with rated voltage applied.
Storage Life	MIL-STD-202 Method 108	150°C, 0 VDC for 1,000 hours.
Vibration	MIL-STD-202 Method 204	5 g's for 20 minutes, 12 cycles each of 3 orientations. Note: Use 8" X 5" PCB 0.031" thick, 7 secure points on one long side and 2 secure points at corners of opposite sides. Parts mounted within 2" from any secure point. Test from 10 – 2,000 Hz.
Mechanical Shock	MIL-STD-202 Method 213	Figure 1 of Method 213, Condition F.
Resistance to Solvents	MIL-STD-202 Method 215	Add aqueous wash chemical, OKEM Clean or equivalent.

## Storage and Handling

Ceramic chip capacitors should be stored in normal working environments. While the chips themselves are quite robust in other environments, solderability will be degraded by exposure to high temperatures, high humidity, corrosive atmospheres, and long term storage. In addition, packaging materials will be degraded by high temperature– reels may soften or warp and tape peel force may increase. KEMET recommends that maximum storage temperature not exceed 40°C and maximum storage humidity not exceed 70% relative humidity. Temperature fluctuations should be minimized to avoid condensation on the parts and atmospheres should be free of chlorine and sulfur bearing compounds. For optimized solderability chip stock should be used promptly, preferably within 1.5 years of receipt.

## Construction

Reference	Item		Material	
A	Termination System	Finish	100% Matte Sn	SnPb (5% min)
B		Barrier Layer	Ni	
D		Base Metal	Cu	
E	Inner Electrode		Ni	
F	Dielectric Material		BaTiO <sub>3</sub>	

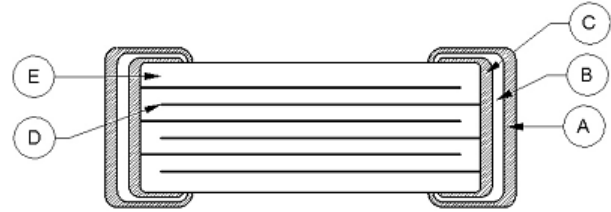

*Note: Image is exaggerated in order to clearly identify all components of construction.*

## Capacitor Marking (Optional):

These surface mount multilayer ceramic capacitors are normally supplied unmarked. If required, they can be marked as an extra cost option. Marking is available on most KEMET devices but must be requested using the correct ordering code identifier(s). If this option is requested, two sides of the ceramic body will be laser marked with a “K” to identify KEMET, followed by two characters (per EIA–198 - see table below) to identify the capacitance value. EIA 0603 case size devices are limited to the “K” character only.

Marking appears in legible contrast. Illustrated below is an example of an MLCC with laser marking of “KA8”, which designates a KEMET device with rated capacitance of 100  $\mu$ F. Orientation of marking is vendor optional.

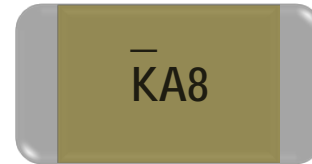

Laser marking option is not available on:

- COG, Ultra Stable X8R and Y5V dielectric devices
- EIA 0402 case size devices
- EIA 0603 case size devices with Flexible Termination option.
- KPS Commercial and Automotive Grade stacked devices.

Capacitance (pF) For Various Alpha/Numeral Identifiers										
Alpha Character	Numeral									
	9	0	1	2	3	4	5	6	7	8
	Capacitance (pF)									
A	0.1	10	10	100	1,000	10,000	100,000	1,000,000	10,000,000	100,000,000
B	0.11	1.1	11	110	1,100	11,000	110,000	1,100,000	11,000,000	110,000,000
C	0.12	12	12	120	1,200	12,000	120,000	1,200,000	12,000,000	120,000,000
D	0.13	13	13	130	1,300	13,000	130,000	1,300,000	13,000,000	130,000,000
E	0.15	15	15	150	1,500	15,000	150,000	1,500,000	15,000,000	150,000,000
F	0.16	16	16	160	1,600	16,000	160,000	1,600,000	16,000,000	160,000,000
G	0.18	18	18	180	1,800	18,000	180,000	1,800,000	18,000,000	180,000,000
H	0.2	20	20	200	2,000	20,000	200,000	2,000,000	20,000,000	200,000,000
J	0.22	22	22	220	2,200	22,000	220,000	2,200,000	22,000,000	220,000,000
K	0.24	24	24	240	2,400	24,000	240,000	2,400,000	24,000,000	240,000,000
L	0.27	27	27	270	2,700	27,000	270,000	2,700,000	27,000,000	270,000,000
M	0.3	30	30	300	3,000	30,000	300,000	3,000,000	30,000,000	300,000,000
N	0.33	33	33	330	3,300	33,000	330,000	3,300,000	33,000,000	330,000,000
P	0.36	36	36	360	3,600	36,000	360,000	3,600,000	36,000,000	360,000,000
Q	0.39	39	39	390	3,900	39,000	390,000	3,900,000	39,000,000	390,000,000
R	0.43	43	43	430	4,300	43,000	430,000	4,300,000	43,000,000	430,000,000
S	0.47	47	47	470	4,700	47,000	470,000	4,700,000	47,000,000	470,000,000
T	0.51	51	51	510	5,100	51,000	510,000	5,100,000	51,000,000	510,000,000
U	0.56	56	56	560	5,600	56,000	560,000	5,600,000	56,000,000	560,000,000
V	0.62	62	62	620	6,200	62,000	620,000	6,200,000	62,000,000	620,000,000
W	0.68	68	68	680	6,800	68,000	680,000	6,800,000	68,000,000	680,000,000
X	0.75	75	75	750	7,500	75,000	750,000	7,500,000	75,000,000	750,000,000
Y	0.82	82	82	820	8,200	82,000	820,000	8,200,000	82,000,000	820,000,000
Z	0.91	91	91	910	9,100	91,000	910,000	9,100,000	91,000,000	910,000,000
a	0.25	25	25	250	2,500	25,000	250,000	2,500,000	25,000,000	250,000,000
b	0.35	35	35	350	3,500	35,000	350,000	3,500,000	35,000,000	350,000,000
d	0.4	40	40	400	4,000	40,000	400,000	4,000,000	40,000,000	400,000,000
e	0.45	45	45	450	4,500	45,000	450,000	4,500,000	45,000,000	450,000,000
f	0.5	50	50	500	5,000	50,000	500,000	5,000,000	50,000,000	500,000,000
m	0.6	60	60	600	6,000	60,000	600,000	6,000,000	60,000,000	600,000,000
n	0.7	70	70	700	7,000	70,000	700,000	7,000,000	70,000,000	700,000,000
i	0.8	80	80	800	8,000	80,000	800,000	8,000,000	80,000,000	800,000,000
y	0.9	90	90	900	9,000	90,000	900,000	9,000,000	90,000,000	900,000,000

## Tape & Reel Packaging Information

KEMET offers multilayer ceramic chip capacitors packaged in 8, 12 and 16 mm tape on 7" and 13" reels in accordance with EIA Standard 481. This packaging system is compatible with all tape-fed automatic pick and place systems. See Table 2 for details on reeling quantities for commercial chips.

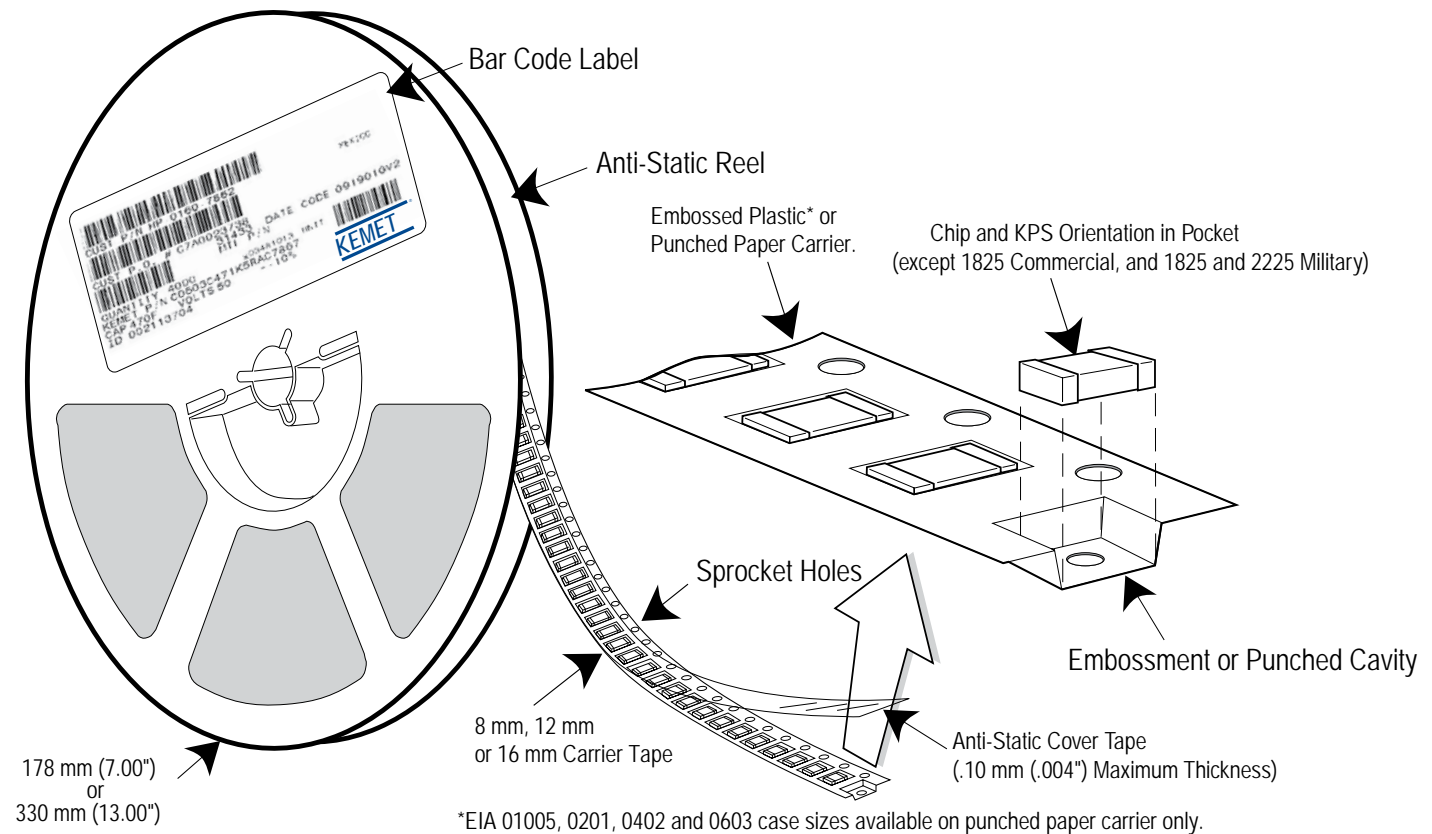

**Table 5 – Carrier Tape Configuration – Embossed Plastic & Punched Paper (mm)**

EIA Case Size	Tape Size (W)*	Pitch (P <sub>1</sub> )*
01005 – 0402	8	2
0603 – 1210	8	4
1805 – 1808	12	4
≥ 1812	12	8
KPS 1210	12	8
KPS 1812 & 2220	16	12
Array 0508 & 0612	8	4

\*Refer to Figures 1 & 2 for W and P<sub>1</sub> carrier tape reference locations.

\*Refer to Tables 6 & 7 for tolerance specifications.

Figure 1 – Embossed (Plastic) Carrier Tape Dimensions

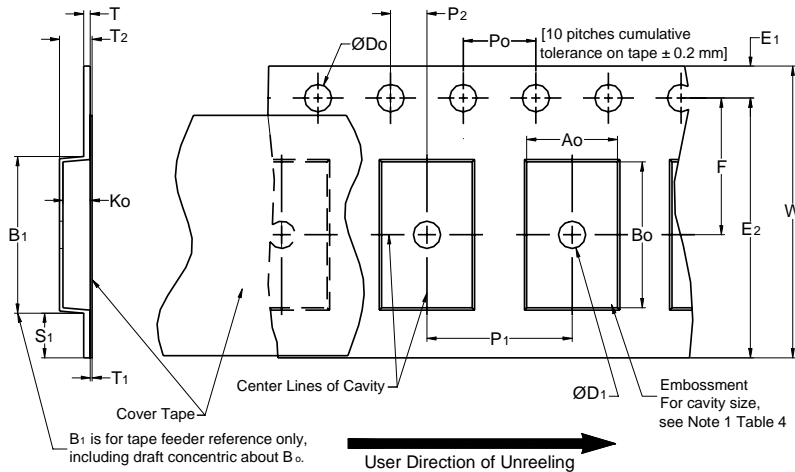

Table 6 – Embossed (Plastic) Carrier Tape Dimensions

Metric will govern

Constant Dimensions — Millimeters (Inches)									
Tape Size	D <sub>0</sub>	D <sub>1</sub> Minimum Note 1	E <sub>1</sub>	P <sub>0</sub>	P <sub>2</sub>	R Reference Note 2	S <sub>1</sub> Minimum Note 3	T Maximum	T <sub>1</sub> Maximum
8 mm	1.5 +0.10/-0.0 (0.059 +0.004/-0.0)	1.0 (0.039)	1.75 ±0.10 (0.069 ±0.004)	4.0 ±0.10 (0.157 ±0.004)	2.0 ±0.05 (0.079 ±0.002)	25.0 (0.984)	0.600 (0.024)	0.600 (0.024)	0.100 (0.004)
12 mm		1.5 (0.059)				30 (1.181)			
16 mm									
Variable Dimensions — Millimeters (Inches)									
Tape Size	Pitch	B <sub>1</sub> Maximum Note 4	E <sub>2</sub> Minimum	F	P <sub>1</sub>	T <sub>2</sub> Maximum	W Maximum	A <sub>0</sub> , B <sub>0</sub> & K <sub>0</sub>	
8 mm	Single (4 mm)	4.35 (0.171)	6.25 (0.246)	3.5 ±0.05 (0.138 ±0.002)	4.0 ±0.10 (0.157 ±0.004)	2.5 (0.098)	8.3 (0.327)	Note 5	
12 mm	Single (4 mm) & Double (8 mm)	8.2 (0.323)	10.25 (0.404)	5.5 ±0.05 (0.217 ±0.002)	8.0 ±0.10 (0.315 ±0.004)	4.6 (0.181)	12.3 (0.484)		
16 mm	Triple (12 mm)	12.1 (0.476)	14.25 (0.561)	7.5 ±0.05 (0.138 ±0.002)	12.0 ±0.10 (0.157 ±0.004)	4.6 (0.181)	16.3 (0.642)		

- The embossment hole location shall be measured from the sprocket hole controlling the location of the embossment. Dimensions of embossment location and hole location shall be applied independent of each other.
- The tape with or without components shall pass around R without damage (see Figure 6).
- If S<sub>1</sub> < 1.0 mm, there may not be enough area for cover tape to be properly applied (see EIA Standard 481 paragraph 4.3 section b).
- B<sub>1</sub> dimension is a reference dimension for tape feeder clearance only.
- The cavity defined by A<sub>0</sub>, B<sub>0</sub> and K<sub>0</sub> shall surround the component with sufficient clearance that:
  - the component does not protrude above the top surface of the carrier tape.
  - the component can be removed from the cavity in a vertical direction without mechanical restriction, after the top cover tape has been removed.
  - rotation of the component is limited to 20° maximum for 8 and 12 mm tapes and 10° maximum for 16 mm tapes (see Figure 3).
  - lateral movement of the component is restricted to 0.5 mm maximum for 8 and 12 mm wide tape and to 1.0 mm maximum for 16 mm tape (see Figure 4).
  - for KPS Series product, A<sub>0</sub> and B<sub>0</sub> are measured on a plane 0.3 mm above the bottom of the pocket.
  - see Addendum in EIA Standard 481 for standards relating to more precise taping requirements.

Figure 2 – Punched (Paper) Carrier Tape Dimensions

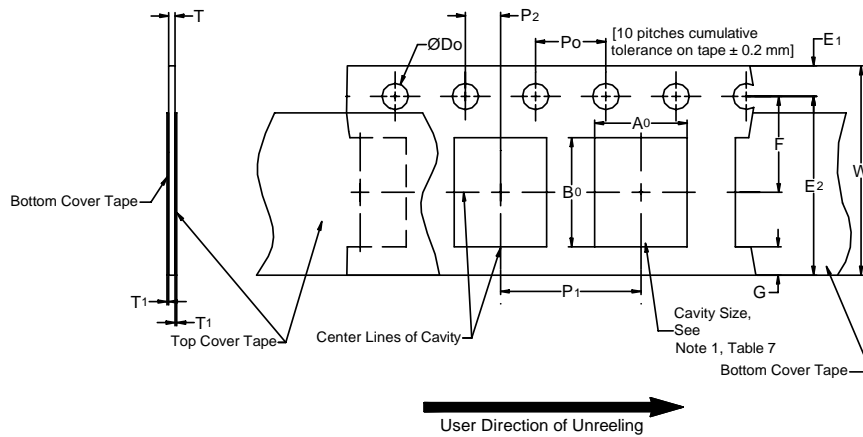

Table 7 – Punched (Paper) Carrier Tape Dimensions

Metric will govern

Constant Dimensions — Millimeters (Inches)							
Tape Size	$D_0$	$E_1$	$P_0$	$P_2$	$T_1$ Maximum	G Minimum	R Reference Note 2
8 mm	$1.5 +0.10 -0.0$ (0.059 +0.004 -0.0)	$1.75 \pm 0.10$ (0.069 ±0.004)	$4.0 \pm 0.10$ (0.157 ±0.004)	$2.0 \pm 0.05$ (0.079 ±0.002)	0.10 (0.004) Maximum	0.75 (0.030)	25 (0.984)
Variable Dimensions — Millimeters (Inches)							
Tape Size	Pitch	E2 Minimum	F	$P_1$	T Maximum	W Maximum	$A_0 B_0$
8 mm	Half (2 mm)	6.25 (0.246)	$3.5 \pm 0.05$ (0.138 ±0.002)	$2.0 \pm 0.05$ (0.079 ±0.002)	1.1 (0.098)	8.3 (0.327)	Note 1
8 mm	Single (4 mm)			$4.0 \pm 0.10$ (0.157 ±0.004)			

- The cavity defined by  $A_0$ ,  $B_0$  and  $T$  shall surround the component with sufficient clearance that:
  - the component does not protrude beyond either surface of the carrier tape.
  - the component can be removed from the cavity in a vertical direction without mechanical restriction, after the top cover tape has been removed.
  - rotation of the component is limited to 20° maximum (see Figure 3).
  - lateral movement of the component is restricted to 0.5 mm maximum (see Figure 4).
  - see Addendum in EIA Standard 481 for standards relating to more precise taping requirements.
- The tape with or without components shall pass around R without damage (see Figure 6).

## Packaging Information Performance Notes

1. Cover Tape Break Force: 1.0 Kg minimum.
2. Cover Tape Peel Strength: The total peel strength of the cover tape from the carrier tape shall be:

Tape Width	Peel Strength
8 mm	0.1 to 1.0 Newton (10 to 100 gf)
12 and 16 mm	0.1 to 1.3 Newton (10 to 130 gf)

The direction of the pull shall be opposite the direction of the carrier tape travel. The pull angle of the carrier tape shall be 165° to 180° from the plane of the carrier tape. During peeling, the carrier and/or cover tape shall be pulled at a velocity of 300 ±10 mm/minute.

3. Labeling: Bar code labeling (standard or custom) shall be on the side of the reel opposite the sprocket holes. Refer to EIA Standards 556 and 624.

### Figure 3 – Maximum Component Rotation

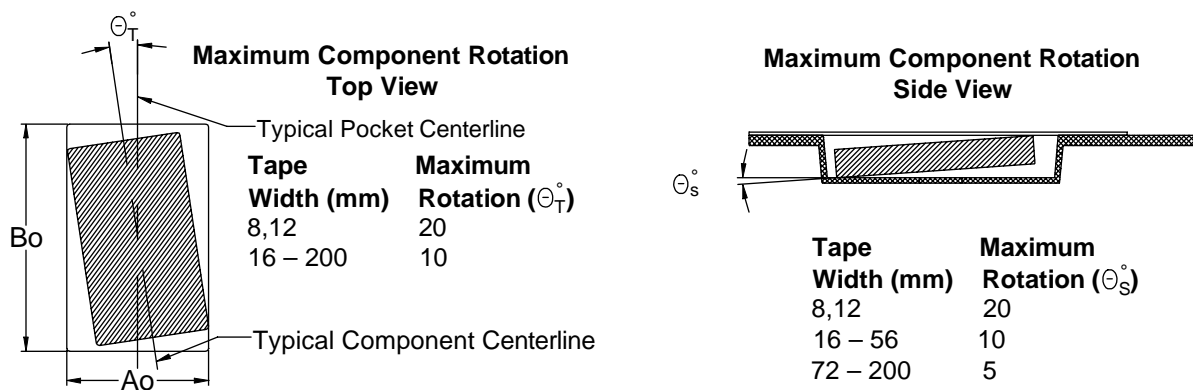

### Figure 4 – Maximum Lateral Movement

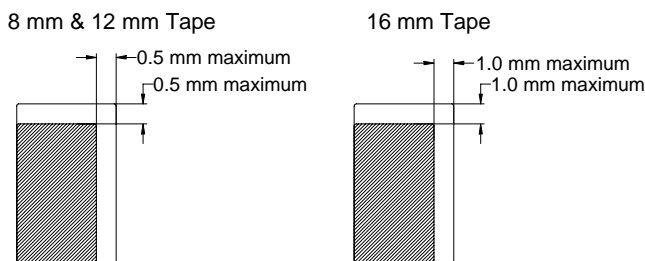

### Figure 5 – Bending Radius

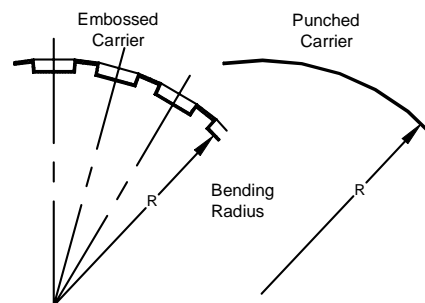



**Figure 6 – Reel Dimensions**

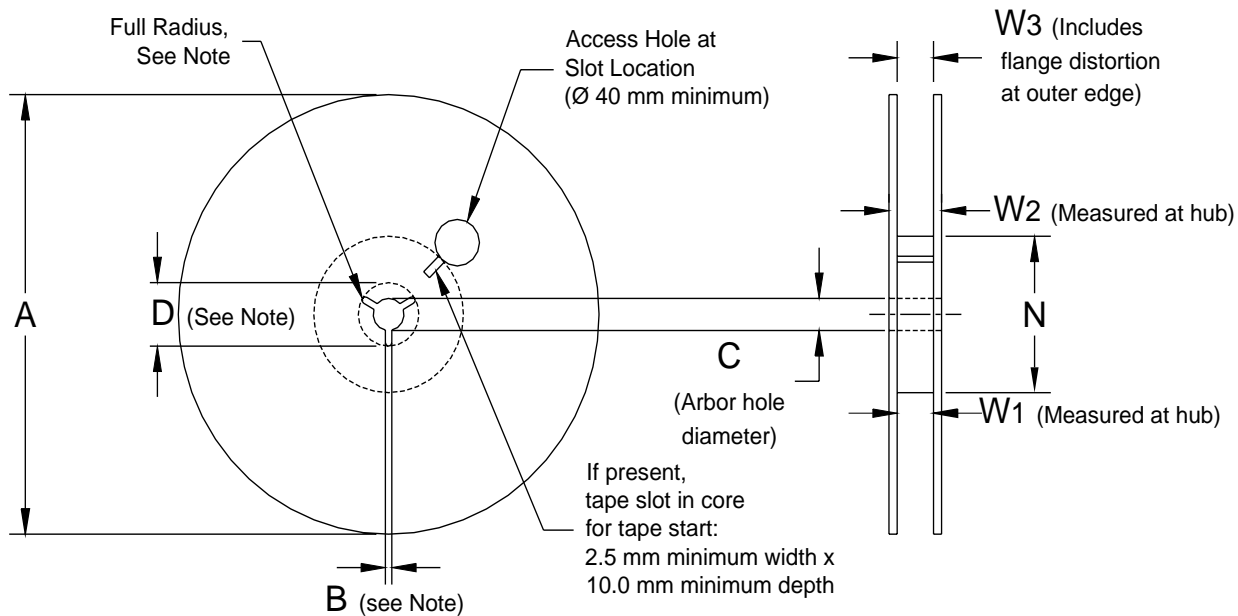

Note: Drive spokes optional; if used, dimensions B and D shall apply.

**Table 8 – Reel Dimensions**

Metric will govern

Constant Dimensions — Millimeters (Inches)				
Tape Size	A	B Minimum	C	D Minimum
8 mm	178 ±0.20 (7.008 ±0.008) or 330 ±0.20 (13.000 ±0.008)	1.5 (0.059)	13.0 +0.5/-0.2 (0.521 +0.02/-0.008)	20.2 (0.795)
12 mm				
16 mm				
Variable Dimensions — Millimeters (Inches)				
Tape Size	N Minimum	W <sub>1</sub>	W <sub>2</sub> Maximum	W <sub>3</sub>
8 mm	50 (1.969)	8.4 +1.5/-0.0 (0.331 +0.059/-0.0)	14.4 (0.567)	Shall accommodate tape width without interference
12 mm		12.4 +2.0/-0.0 (0.488 +0.078/-0.0)	18.4 (0.724)	
16 mm		16.4 +2.0/-0.0 (0.646 +0.078/-0.0)	22.4 (0.882)	

**Figure 7 – Tape Leader & Trailer Dimensions**

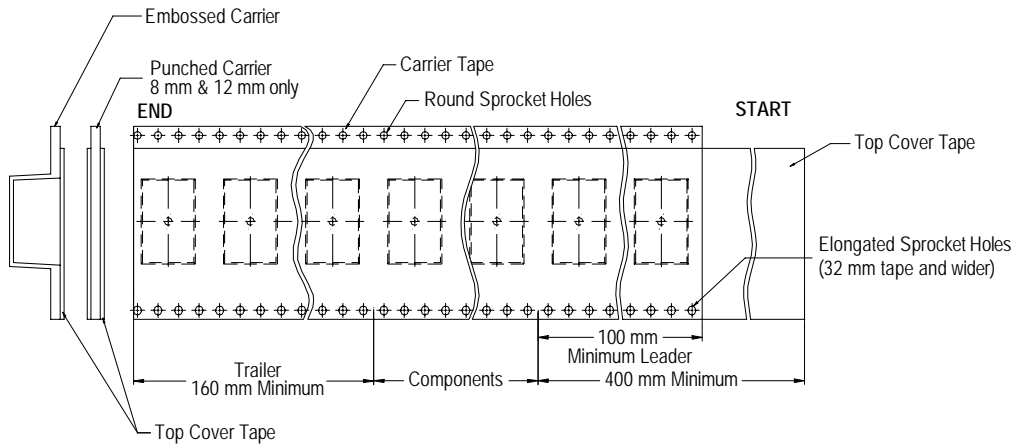

**Figure 8 – Maximum Camber**

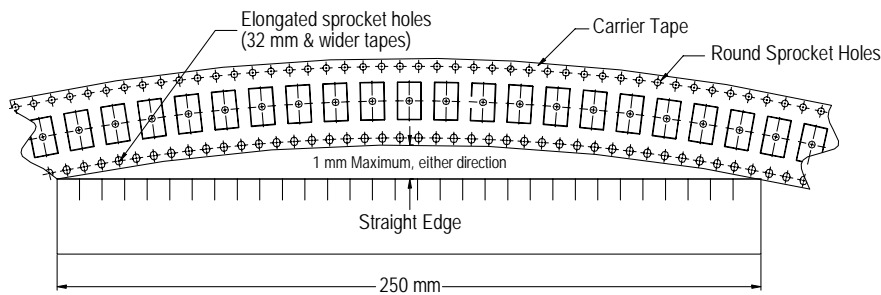

## KEMET Corporation World Headquarters

2835 KEMET Way  
Simpsonville, SC 29681

Mailing Address:  
P.O. Box 5928  
Greenville, SC 29606

www.kemet.com  
Tel: 864-963-6300  
Fax: 864-963-6521

**Corporate Offices**  
Fort Lauderdale, FL  
Tel: 954-766-2800

## North America

**Southeast**  
Lake Mary, FL  
Tel: 407-855-8886

**Northeast**  
Wilmington, MA  
Tel: 978-658-1663

**Central**  
Novi, MI  
Tel: 248-994-1030

**West**  
Milpitas, CA  
Tel: 408-433-9950

**Mexico**  
Guadalajara, Jalisco  
Tel: 52-33-3123-2141

## Europe

**Southern Europe**  
Paris, France  
Tel: 33-1-4646-1006

**Sasso Marconi, Italy**  
Tel: 39-051-939111

**Central Europe**  
Landsberg, Germany  
Tel: 49-8191-3350800

**Kamen, Germany**  
Tel: 49-2307-438110

**Northern Europe**  
Bishop's Stortford, United Kingdom  
Tel: 44-1279-460122

**Espoo, Finland**  
Tel: 358-9-5406-5000

## Asia

**Northeast Asia**  
Hong Kong  
Tel: 852-2305-1168

**Shenzhen, China**  
Tel: 86-755-2518-1306

**Beijing, China**  
Tel: 86-10-5829-1711

**Shanghai, China**  
Tel: 86-21-6447-0707

**Taipei, Taiwan**  
Tel: 886-2-27528585

**Southeast Asia**  
Singapore  
Tel: 65-6586-1900

**Penang, Malaysia**  
Tel: 60-4-6430200

**Bangalore, India**  
Tel: 91-806-53-76817

*Note: KEMET reserves the right to modify minor details of internal and external construction at any time in the interest of product improvement. KEMET does not assume any responsibility for infringement that might result from the use of KEMET Capacitors in potential circuit designs. KEMET is a registered trademark of KEMET Electronics Corporation.*

## Other KEMET Resources

Tools	
Resource	Location
Configure A Part: CapEdge	<a href="http://capacitoredge.kemet.com">http://capacitoredge.kemet.com</a>
SPICE & FIT Software	<a href="http://www.kemet.com/spice">http://www.kemet.com/spice</a>
Search Our FAQs: KnowledgeEdge	<a href="http://www.kemet.com/keask">http://www.kemet.com/keask</a>
Electrolytic LifeCalculator	<a href="http://www.kemet.com:8080/elc">http://www.kemet.com:8080/elc</a>

Product Information	
Resource	Location
Products	<a href="http://www.kemet.com/products">http://www.kemet.com/products</a>
Technical Resources (Including Soldering Techniques)	<a href="http://www.kemet.com/technicalpapers">http://www.kemet.com/technicalpapers</a>
RoHS Statement	<a href="http://www.kemet.com/rohs">http://www.kemet.com/rohs</a>
Quality Documents	<a href="http://www.kemet.com/qualitydocuments">http://www.kemet.com/qualitydocuments</a>

Product Request	
Resource	Location
Sample Request	<a href="http://www.kemet.com/sample">http://www.kemet.com/sample</a>
Engineering Kit Request	<a href="http://www.kemet.com/kits">http://www.kemet.com/kits</a>

Contact	
Resource	Location
Website	<a href="http://www.kemet.com">www.kemet.com</a>
Contact Us	<a href="http://www.kemet.com/contact">http://www.kemet.com/contact</a>
Investor Relations	<a href="http://www.kemet.com/ir">http://www.kemet.com/ir</a>
Call Us	1-877-MyKEMET
Twitter	<a href="http://twitter.com/kemetcapacitors">http://twitter.com/kemetcapacitors</a>

## Disclaimer

All product specifications, statements, information and data (collectively, the "Information") are subject to change without notice.

All Information given herein is believed to be accurate and reliable, but is presented without guarantee, warranty, or responsibility of any kind, expressed or implied.

Statements of suitability for certain applications are based on our knowledge of typical operating conditions for such applications, but are not intended to constitute – and we specifically disclaim – any warranty concerning suitability for a specific customer application or use. This Information is intended for use only by customers who have the requisite experience and capability to determine the correct products for their application. Any technical advice inferred from this Information or otherwise provided by us with reference to the use of our products is given gratis, and we assume no obligation or liability for the advice given or results obtained.

Although we design and manufacture our products to the most stringent quality and safety standards, given the current state of the art, isolated component failures may still occur. Accordingly, customer applications which require a high degree of reliability or safety should employ suitable designs or other safeguards (such as installation of protective circuitry or redundancies) in order to ensure that the failure of an electrical component does not result in a risk of personal injury or property damage.

Although all product-related warnings, cautions and notes must be observed, the customer should not assume that all safety measures are indicated or that other measures may not be required.

