

SMD Auto X7R, Ceramic, 1.5 uF, 10%, 50 VDC, X7R, SMD, MLCC, Temperature Stable, Automotive Grade, 1812

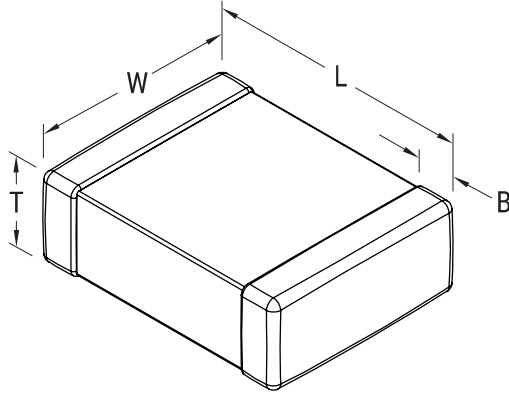

**Dimensions**

Chip Size	1812
L	4.5mm +/-0.3mm
W	3.2mm +/-0.3mm
T	1.1mm +/-0.10mm
B	0.6mm +/-0.35mm

**Packaging Specifications**

Packaging:	T&R, 180mm, Plastic Tape
Packaging Quantity:	1000

**General Information**

Series:	SMD Auto X7R
Style:	SMD Chip
Description:	SMD, MLCC, Temperature Stable, Automotive Grade
Features:	Temperature Stable, Automotive Grade
RoHS:	Yes
Termination:	Tin
Marking:	No
Qualifications:	AEC-Q200
AEC-Q200:	Yes
Component Weight:	95 mg
Shelf Life:	78 Weeks
MSL:	1

**Specifications**

Capacitance:	1.5 uF
Measurement Condition:	1 kHz 1.0Vrms
Capacitance Tolerance:	10%
Voltage DC:	50 VDC
Dielectric Withstanding Voltage:	125 VDC
Temperature Range:	-55/+125°C
Temperature Coefficient:	X7R
Capacitance Change with Reference to +25°C and 0 VDC Applied (TCC):	15%, 1kHz 1.0Vrms
Dissipation Factor:	2.5% 1 kHz 1.0Vrms
Aging Rate:	3% Loss/Decade Hour: Referee Time is 1000 Hours
Insulation Resistance:	666.7 MOhms