

SPACE SPLICE Patent Pending

High Reliability Connecting Solution

www.ck-components.com

SPACE SPLICE

- One way connector for linking 2 wires with removable contacts. Using D*MA crimpable contact technology.
- EPPL2 Product (ESA/ESCC European Preferred Part List part2)
- Easy to use.
- Compact format and designed to accept the most popular cable gauges (AWG 20 to AWG 30).
- Replacement of manual splices by standard solution.
- Low residual magnetism.
- Low degassing.
- High radiation and temperature resistance (PEEK material).
- Packaging unit: 250 pieces (plastic bag).

HOW TO USE

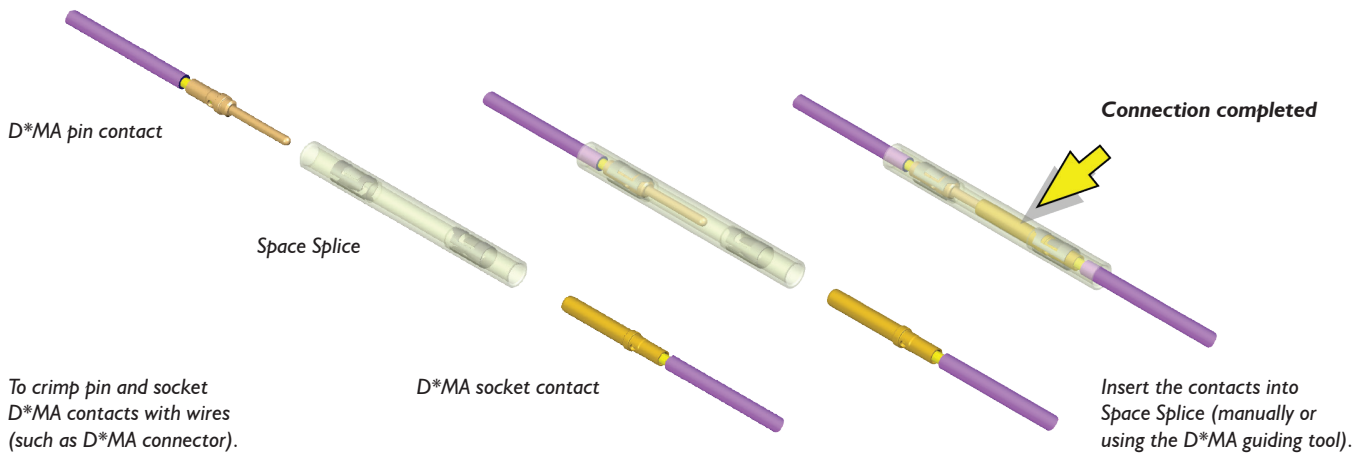

STANDARD FEATURES

Dimensions

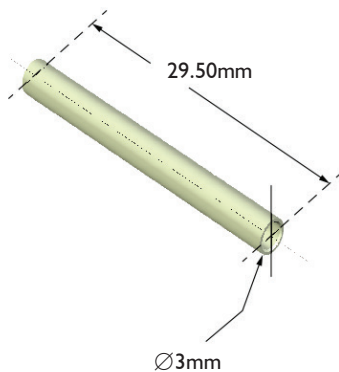

Materials and Finishes

COMPONENT	MATERIAL	FINISH
Insulator	PEEK	UL 94-V0, natural color
Clip	Beryllium Copper Alloy	Raw material
Socket Contacts	Copper Alloy	1.27 μm Gold over Copper underlayer
Pin Contacts	Copper Alloy	1.27 μm Gold over Copper underlayer

Electrical and Mechanical Characteristics

CHARACTERISTIC	VALUE
Operating Temperature	-55 / +125 °C
Storage Temperature	-65 / +125 °C
Working Voltage (sea level)	300 Vrms
Voltage Proof leakage current	1250 Vrms
Insulator Resistance at 500 V DC	5000 M Ω min.
Maximum Rated Current	7.5 A
Contact Resistance	5 m Ω
Residual Magnetism Level (NMB)	< 200 Gamma
Radiation Resistance	> 1 x 10 ⁸ Rads
Contact Insertion & Withdrawal Force	1st contact < 18.5 N
Contact Insertion & Withdrawal Force	2nd contact < 21.8 N
Contact Retention	40 N max.
Weight	0.2 gr max.

HOW TO ORDER

SPACE SPLICE

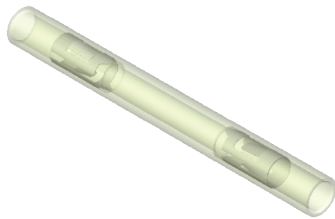

Series
Variant
Insert Type
MA for two-piece insert with metal retention clips for crimp contacts

Code for Space Level According to **FR039** C&K specification
Magnetism level
NMB 200 Gamma
Contact type
PS Pin + Socket contacts

PIN CONTACT

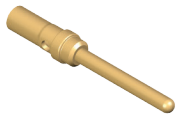

Specification Number
Size
01 Standard 20/20 (wire size 20 / 22 / 24)
03 Reduced 20/26 (wire size 26 / 28 / 30*)
Testing Level

- Contacts are ESA/ESCC quality level.
- Contacts are without marking and without ink color coding.
- Residual magnetism level NMB (200 Gamma max).
- Packaging unit: 250 pieces (plastic bag).

Note *: Not approved by ESA.

SOCKET CONTACT

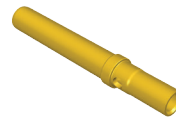

Specification Number
Size
02 Standard 20/20 (wire size 20 / 22 / 24)
04 Reduced 20/26 (wire size 26 / 28 / 30*)
Testing Level

ACCESSORIES

CRIMPING TOOL: M22520/02-01



LOCATOR:

For Contact 20/20: M22520/2-08
 For Contact 20/26: M22520/2-08



EXTRACTION TOOL: CET-20-11



1st CONTACT PROBE FOR RETENTION TOOL:
 SPLICE-TOOL-RETENTION-01

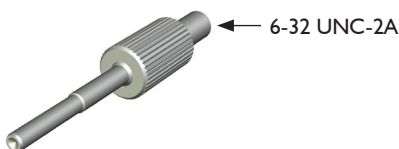

2nd CONTACT PROBE FOR RETENTION TOOL:
 SPLICE-TOOL-RETENTION-02

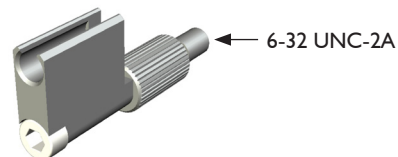

Probes compatible with OCETA retention tool OCE8



TYPICAL APPLICATIONS



Space: Space Splice is manufactured in accordance with ESA/ESCC specification, meeting the highest quality requirements for satellite structure, payloads, harnesses...

Space Splice key application is one way wire connection for heater, thermistor, MLI (Multi Layer Insulator...)



Other Applications: Space Splice is the ideal choice for the connection of 2 wires with removable contact option.

Low magnetism level and high resistance to radiation allow to use it in harsh environment such as laboratory, avionics, military, and medical equipments.

ADDITIONAL INFORMATION

Standard part number features are available on our website. C&K recommends to contact your local sales representative to confirm product availability. Please note that for some applications, especially Space, some versions are dedicated to typical versions. Technical specifications are available on request, on our website under “ask a specialist” item or through your sales representative.

AMERICAS

Tel: +1.617.969.3700

ASIA

Tel: +852.3713.5288

EUROPE

Tel: +33.1.60.24.51.51

