

KEMET Part Number: C0805J224K4RACTU
(C0805J224K4RAC7800)

SMD Comm X7R FO, Ceramic, 0.22 uF, 10%, 16 VDC, X7R, SMD, MLCC, Open Mode, Temperature Stable, 0805

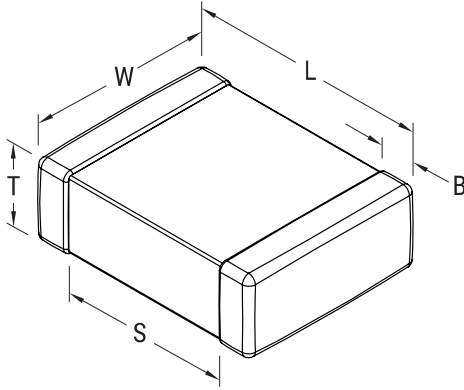

Dimensions

Chip Size	0805
L	2mm +/-0.3mm
W	1.25mm +/-0.3mm
T	1.25mm +/-0.15mm
S	0.75mm MIN
B	0.5mm +/-0.25mm

Packaging Specifications

Packaging:	T&R, 180mm, Plastic Tape
Packaging Quantity:	2500

General Information

Series:	SMD Comm X7R FO
Style:	SMD Chip
Description:	SMD, MLCC, Open Mode, Temperature Stable
Features:	Open Mode, Temperature Stable
RoHS:	Yes
Termination:	Flexible Termination
Marking:	No
AEC-Q200:	No
Component Weight:	21 mg
Shelf Life:	78 Weeks
MSL:	1

Specifications

Capacitance:	0.22 uF
Measurement Condition:	1 kHz 1.0Vrms
Capacitance Tolerance:	10%
Voltage DC:	16 VDC
Dielectric Withstanding Voltage:	40 VDC
Temperature Range:	-55/+125°C
Temperature Coefficient:	X7R
Capacitance Change with Reference to +25°C and 0 VDC Applied (TCC):	15%, 1kHz 1.0Vrms
Dissipation Factor:	3.5% 1 kHz 1.0Vrms
Aging Rate:	3% Loss/Decade Hour: Referee Time is 1000 Hours
Insulation Resistance:	2.2727 GOhms