

SMD Auto X7R, Ceramic, 820 pF, 10%, 50 VDC, X7R, SMD, MLCC, Temperature Stable, Automotive Grade, 0603

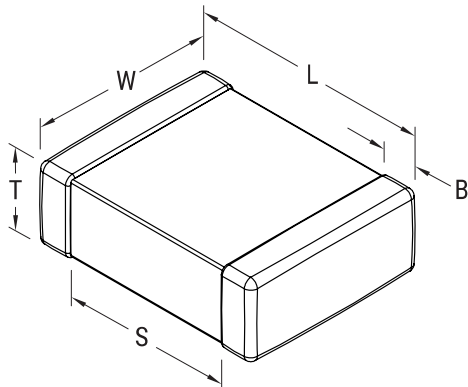

Dimensions

Dimensions	
Chip Size	0603
L	1.6mm +/-0.15mm
W	0.8mm +/-0.15mm
T	0.8mm +/-0.07mm
S	0.7mm MIN
B	0.35mm +/-0.15mm

Packaging Specifications

Packaging:	T&R, 180mm, Paper Tape
Packaging Quantity:	4000

General Information

Series:	SMD Auto X7R
Style:	SMD Chip
Description:	SMD, MLCC, Temperature Stable, Automotive Grade
Features:	Temperature Stable, Automotive Grade
RoHS:	Yes
Termination:	Tin
Marking:	No
Qualifications:	AEC-Q200
AEC-Q200:	Yes
Component Weight:	4800 ug
Shelf Life:	78 Weeks
MSL:	1

Specifications

Capacitance:	820 pF
Measurement Condition:	1 kHz 1.0Vrms
Capacitance Tolerance:	10%
Voltage DC:	50 VDC
Dielectric Withstanding Voltage:	125 VDC
Temperature Range:	-55/+125°C
Temperature Coefficient:	X7R
Capacitance Change with Reference to +25°C and 0 VDC Applied (TCC):	15%, 1kHz 1.0Vrms
Dissipation Factor:	2.5% 1 kHz 1.0Vrms
Aging Rate:	3% Loss/Decade Hour: Referee Time is 1000 Hours
Insulation Resistance:	100 GOhms