

## Table of Contents

### Cable Ties and Installation Tooling

#### Available Styles

<i>PAN-TY</i> ® Locking Cable Ties, Locking Lashing Ties, Releasable Ties, Releasable Lashing Ties, Clamp Ties, Marker and Flag Ties, Winged Push Mount Ties, Push Mount Ties, Weather Resistant Ties, Polypropylene Ties, Flame Retardant Ties, Nylon 12 Ties, HALAR* Ties, TEFZEL** Ties, Fluorescent Ties . . . . .	6-26
<i>DOME-TOP</i> ® Barb Ty Cable Ties, Clamp Ties, Marker Ties, <i>DURA-TY</i> ™ WR Cable Ties, Heat Stabilized Ties, Winged Push Mount Ties . . . . .	27-35
Parallel Entry ( <i>CONTOUR-TY</i> ® Cable Ties, <i>BELT-TY</i> ™ IN-LINE Cable Ties, IN-LINE Cable Ties) . . . . .	36-39
Hook & Loop Cable Ties ( <i>TAK-TY</i> ® Hook & Loop Cable Ties, Hook & Loop Strips/Rolls) . . . . .	40-42
<i>STA-STRAP</i> ® Clamp Ties, Cable Ties, Chassis/Panel Mount Ties . . . . .	43-45
Specialty Ties (Stud Mounted Heat Stabilized, Releaseable Stud Mounted “Ladder” Cable Ties, Multiple Loop, Double Hose Clamp, Polyethylene Marker Strap) . . . . .	46-50
<i>PAN-POUCH</i> ™ Telephone Cable Identification Kit . . . . .	53
Cable Tie Kits . . . . .	54
Cable Tie Installation Tools (manual/pneumatic/automatic) . . . . .	55-61

#### Available Materials

Nylon 6.6 Cable Ties . . . . .	6-13, 28, 30-33, 36-38, 43, 47
Heat Stabilized Nylon 6.6 Cable Ties . . . . .	12, 30, 44, 46
Weather Resistant Nylon 6.6 Cable Ties . . . . .	14-18, 29, 31, 36, 38, 47, 48
Polypropylene Cable Ties . . . . .	18-19
Flame Retardant Nylon 6.6 Cable Ties . . . . .	20
Weather Resistant Nylon 12 Cable Ties . . . . .	21
HALAR* and TEFZEL** Cable Ties . . . . .	22
Fluorescent Ties . . . . .	23
Weather Resistant Acetal Cable Ties . . . . .	33
Hook & Loop Cable Ties . . . . .	40-42
Polyethylene Marker Straps . . . . .	49

#### Additional Information

Lashing Ties . . . . .	7, 8, 15, 16
Military Cross Reference Aerospace Standard Information . . . . .	51
Custom Hot Stamping . . . . .	52
Selecting the Proper Cable Tie Material for Your Application . . . . .	62
Material Selection Guide . . . . .	63
Weathering . . . . .	64-65
Flammability . . . . .	66-67
Radiation/Moisture/Temperature/Tensile Strength . . . . .	68
Physical Characteristics of Cable Tie Materials . . . . .	69
Chemical Resistance . . . . .	70-74
Quality . . . . .	75-76

### Stainless Steel Tie Products

<i>PAN-STEEL</i> ® Stainless Steel Tie . . . . .	77
<i>WAVE-TY</i> ™ Superior Grip Standard Steel Tie . . . . .	77
Stainless Steel Tie Installation Tools . . . . .	78
Metal Marker Plates/Tags/Marking Devices . . . . .	78
Stainless Steel Strapping . . . . .	80

### Wiring Accessories

Cable Tie Accessories . . . . .	85-107
Wiring Accessories — used without cable ties . . . . .	108-123
Harness Board Accessories . . . . .	124-129
Communication Cable Management . . . . .	130-133
Selection and Use of Adhesive Mounts . . . . .	134-136
Abrasion Protection Products (Heat Shrink, Non-Shrink PVC Tubing, Spiral Wrap, Grommet Edging and Braided Expandable Sleeving) . . . . .	139-181

\*HALAR is a registered trademark of Solvay Solexis, Inc.  
 \*\*TEFZEL is a registered trademark of E.I. DuPont de Nemours Co.  
 All reference dimensions in this catalog are shown in inches (and millimeters).

## World Leader in Cable Ties and Wiring Accessories

PANDUIT® is a leading global producer of cable ties and wiring accessories, offering the most complete selection of sizes, styles and materials. We continually provide new cable tie and wiring accessory designs to meet the changing application challenges encountered by our customers while providing lowest installed costs.

PANDUIT® also offers the largest selection of ergonomic cable tie installation tools — from high speed automatic systems to hand operated tools. So, whatever the need, PANDUIT® has the tool to help lower your total installed cost.



### Assured Quality

To help assure optimum quality, PANDUIT® products are designed and manufactured to meet applicable international, UL, military and customer standards:

#### ISO 9001



The International Standards Organization (ISO) establishes worldwide standards for products and services in recognition of increasing globalization of markets. The ISO program sets up the requirements for quality assurance systems of these worldwide standards. PANDUIT® is registered to ISO 9001, the most comprehensive model in the standard, meant for companies who design, manufacture, install and service the products they sell. Registration has been awarded by Underwriters Laboratories (Certificate No. A2269) after extensive audit of QA systems employed at PANDUIT®.

#### QS-9000

QS-9000 is the shorthand name for "Quality System Requirements QS-9000." It is the common supplier quality standard for the automotive industry. QS-9000 is based on the 1994 edition of ISO 9001, but it contains additional requirements that are particular to the automotive industry. These additions are considered automotive "interpretations" by the ISO community of accreditation bodies and registrars. Registration has been awarded by Underwriters Laboratories Inc. (Certificate No. A2269) for PANDUIT® cable ties.

#### ISO14001



ISO14001 is a voluntary standard for Environmental Management Systems established by the International Organization for Standardization. The international standard provides a benchmark for continual improvement in environmental performance. Business partners can be confident that the PANDUIT® manufacturing facilities around the globe are engaged in an on-going process to maximize value while minimizing impact on global natural resources.

### Underwriters Laboratories, Inc. (File E56854)



Most PANDUIT® miniature, intermediate, standard, light-heavy and heavy cross-section ties are Recognized (ZODZ(8)) or Listed in the US and Canada by Underwriters Laboratories (ZODZ(7)) in their Directory under the category "Wire Positioning Devices." Natural, pigmented and weather resistant cable ties are recognized for indoor use at temperatures up to 85°C (185°F). Weather resistant cable ties are also UL Listed for outdoor applications. Heat stabilized ties are UL Recognized and Listed for indoor use at temperatures up to 115°C (239°F).

### Aerospace Standard AS23190



Aerospace Standard SAE spec AS23190 covers the actual test requirements on cable ties. PANDUIT® cable ties, when tested, either meet or exceed the requirements of this specification.

### Nuclear Regulatory Commission

The NRC developed rules and regulations concerning Quality Assurance Criteria for Nuclear Power Plants or Title 10, Chapter 10, Part 50, Appendix B (10CFR50). PANDUIT® Corp. Quality Assurance program is designed to satisfy the 18 criteria set forth in NRC 10CFR50, Appendix B, Military Specification AS23190.

### Ford Motor Company



PANDUIT® has received Q1 certification status from Ford Motor Company. Q1 certification enables all PANDUIT® cable tie manufacturing facilities to approve all initial samples and production shipments of the parts destined for Ford operations throughout the world.

### International Approvals Independent Testing Facilities

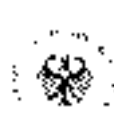

German (VG) Military



Lloyd's Register of Shipping



RINA



Germanischer Lloyd



Nippon Kaiji Kyokai



Det Norske Veritas



Bureau Veritas



Korean Register of Shipping



## Selection Guide

### PAN-TY® Cable Ties



This line offers the largest selection of styles, materials, and sizes. The ties are available in nylon 6.6, nylon 12, polypropylene, HALAR\* and TEFZEL\*\* material. Available in sizes from .60" (15mm) maximum bundle diameter up to 13" (330mm) maximum bundle diameter. All are self-locking and many sizes are available in both releasable and non-releasable types. PAN-TY® Cable Ties are quickly installed by hand or with PANDUIT® installation tools.

### DURA-TY™ Cable Ties



DURA-TY™ is a heavy-duty cable tie that is ideal for all outdoor applications requiring high strength and longer life. The acetal strap and head provides excellent UV light resistance and high tensile strength. The smooth, rounded edges on the head and body do not irritate the hands. The ties are easy to install. Available in standard lengths or dispenser rolls for easy, cut to length convenience in custom applications.

### DOME-TOP® Barb Ty Cable Ties



These cable ties provide consistent performance and reliability for those users who prefer a cable tie with a stainless steel locking barb. They are infinitely adjustable through their entire bundle range. On selected popular sizes, the additional length of DOME-TOP® Barb Ty Cable Ties provides an average of 30% more bundle area than other metal barb cable ties. Available in sizes from .90" (23mm) maximum bundle diameter up to 9.0" (229mm) maximum bundle diameter and may be installed by hand or with PANDUIT® installation tools.

### Parallel Entry Cable Ties



Parallel Entry Ties are comprised of the CONTOUR-TY®, BELT-TY™ and IN-LINE Cable Tie families. CONTOUR-TY® Cable Tie's fully enclosed locking wedge insures consistent strength, lasting performance and it is available in a new heavy-standard cross section. BELT-TY™ Cable Ties have low profile heads which help avoid snags and reduce overall bundle size. IN-LINE Cable Ties are exceptional for applications that require conformity to large bundles. Unique IN-LINE design forms completely around the bundle, increasing the contact area. Serrations on the side of the head assure positive grip during threading of the tie and increases installation speed.

\*HALAR is a registered trademark of Solvay Solexis, Inc.  
\*\*TEFZEL is a registered trademark of E.I. DuPont de Nemours Co.

## Selection Guide (cont.)

### TAK-TY® Hook & Loop Cable Ties



PANDUIT® TAK-TY® Hook & Loop Cable Ties are ideal for applications that require frequent cabling moves, adds and changes. They can be used to secure a wide variety of various sizes of cable bundles. Wide color choice allows for quick and easy color coding of separate cable bundles.

### STA-STRAP® Cable Ties



STA-STRAP® Cable Ties offer several unique features. Harness modifications during assembly are made easy as the two-piece design affords releasability prior to final tensioning and cut-off. The ties are extremely flexible and lightweight. They also provide the lowest thread force in the industry which reduces operator fatigue. The unique design allows this cable tie to secure a bundle directly to a panel without the need for additional fasteners or mounting devices and reduces installation costs.

### Specialty Ties



PANDUIT® continually develops new products to help solve the unique application problems of our customers. One of these products is the polyethylene cable marker strap that is used for identifying telephone and fiber optic cable, which typifies the design/manufacturing capability of PANDUIT® to respond to these special needs.

### Stainless Steel Ties and Strapping



Underground, underwater, indoors, outdoors — however hostile the environment — PANDUIT® Stainless Steel Ties and Strapping fasten and identify components and cables quickly and easily. Stainless steel ties stand up to most chemicals, to nuclear and ultraviolet radiation, to seawater and direct burial in any soil, and to temperature extremes from -112°F to 1700°F (-80°C to 925°C).

## PAN-TY® Cable Tie Features/Benefits:

### 1. One Piece Construction

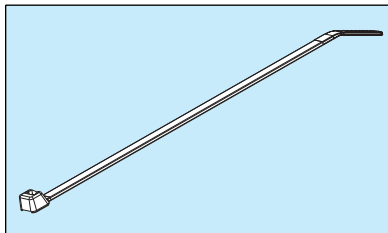

- Consistent performance and reliability
- Available in lengths from 2.8" (71mm) up to 43.3" (1100mm) to meet a variety of application requirements

### 2. Smooth, Round Edges

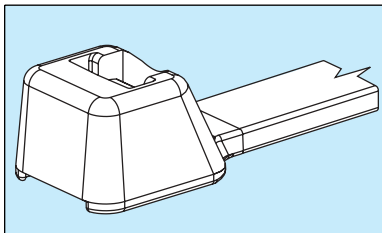

- No irritation to installer's hands, increases productivity
- Prevents damage to wire insulation

### 3. Tensile Strength

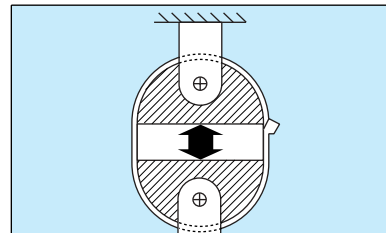

- Exceeds Industry and Aerospace Standards SAE (AS23190) standards
- Available in seven loop tensile strengths from 8 lbs. (36N) up to 250 lbs. (1112N) to provide an economical selection

### 4. Curved Tip

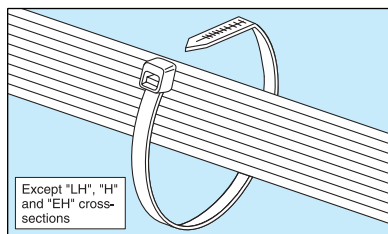

- Orients tip toward head to speed installation — lowers installed cost
- Faster initial threading
- Easier to pick up from flat surfaces

### 5. Finger Tip Grip

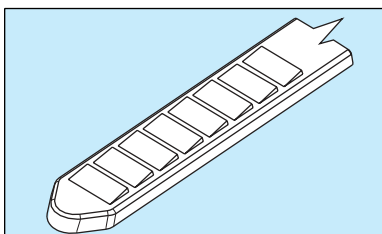

- Finger tip grip on selected sizes assures positive grip during threading of the tie
- Grip prevents tip from slipping out of cable tie head during threading

### 6. More Teeth Per Inch

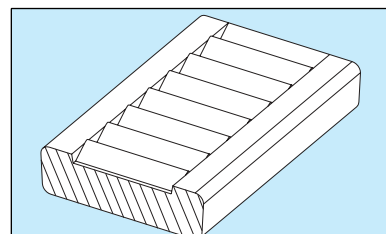

- Greater number of small uniform teeth provides tighter bundles
- Because they are flush with surface they provide proper wire bundle grip without wire insulation damage

### 7. Low Threading Force

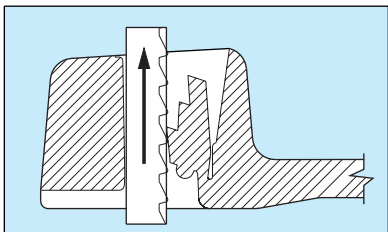

- Lowest threading force of any one piece cable tie in the industry
- Reduces operator fatigue
- Thin tapered tip facilitates threading, easier initial insertion

### 8. One Piece Locking Design

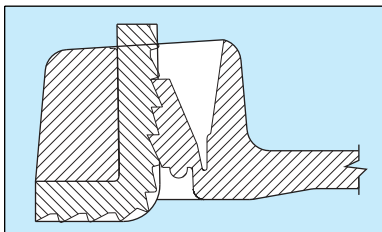

- Multiple locking tooth design provides greater strength and reliability
- Available in self locking or releasable styles for use in applications where changes are anticipated

### 9. Material Availability

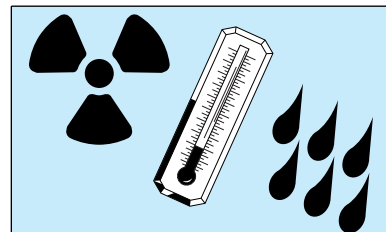

- Available in a variety of materials to meet the needs of special environments
- Properly selected ties can be used indoors or outdoors with assurance of long lasting performance

# PANDUIT® Nylon 6.6 Locking Cable Ties (PLT Series)

## PAN-TY® Nylon 6.6 Locking Cable Ties — Curved Tip



These versatile fasteners can be used in countless applications wherever you need to bundle wire, cable, or hose. They tie bundle diameters up to 13" (330mm), they also can be joined together for even larger diameters. They have a minimum loop tensile strength from 8 lbs. (36N) to 250 lbs. (1112N). Colors are available for specific color-coding applications (see pages 24-26).

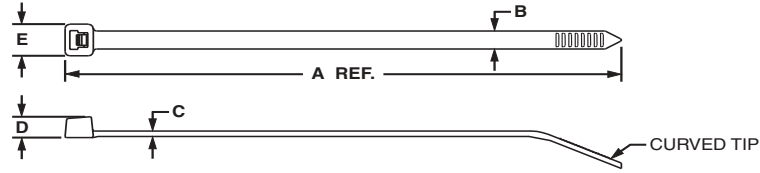

Cable Ties for Automatic Tools See Page 61.

### SUBMINIATURE AND MINIATURE CROSS SECTION

Part Number	Length A in. (mm)	Width B in. (mm)	Thickness C in. (mm)	Head Height D in. (mm)	Head Width E in. (mm)	Max. Bundle Dia. in. (mm)	Min. Loop Tensile Strength Lbs. (N)	Recommended PANDUIT® Installation Tool Part No.	Packaging*			
									Std. Pkg. Qty.	Std. Ctn. Qty.	Bulk Pkg. Qty.	Bulk Ctn. Qty.
<b>PLT.6SM-C</b>	2.8 (71)	.070 (1.8)	.030 (.8)	.095 (2.4)	.125 (3.2)	.60 (15)	8 (36)	GTS, PTS	100	1000	1000	50000
<b>PLT.7M-C</b>	3.1 (79)	.090 (2.3)	.032 (.8)	.115 (2.9)	.180 (4.6)	.68 (17)	18 (80)	GTS, GS2B, PTS, PPTS or STS2	100	1000	1000	50000
<b>PLT1M-C</b>	3.9 (99)	.098 (2.5)	.043 (1.1)	.154 (3.9)		.87 (22)			100	1000	1000	50000
<b>PLT1.5M-C</b>	5.6 (142)					1.25 (32)			100	1000	1000	50000
<b>PLT2M-C</b>	8.0 (203)					2.00 (51)			100	1000	1000	25000

### INTERMEDIATE CROSS SECTION

<b>PLT1.5I-C</b>	5.6 (142)	.142 (3.6)	.045 (1.1)	.180 (4.6)	.240 (6.1)	1.38 (35)	40 (178)	GTS, GS2B, PTS, PPTS or STS2	100	1000	1000	25000
<b>PLT2I-C</b>	8.0 (203)					2.00 (51)			100	1000	1000	25000
<b>PLT2.5I-C</b>	9.7 (246)	.145 (3.7)	.052 (1.3)	.180 (4.6)	.260 (6.6)	2.50 (64)	40 (178)	GTS, GS2B, PTS, PPTS or STS2	100	1000	1000	10000
<b>PLT3I-C</b>	11.4 (290)					3.00 (76)			100	1000	1000	10000
<b>PLT4I-C</b>	14.5 (368)					4.00 (102)			100	1000	1000	10000

### STANDARD CROSS SECTION

<b>PLT1S-C</b>	4.8 (122)	.190 (4.8)	.052 (1.3)	.220 (5.6)	.316 (8.0)	1.00 (25)	50 (222)	GTS, GS2B, GTH, GS4H, PTS, PPTS, STS2 or STH2	100	1000	1000	25000
<b>PLT1.5S-C</b>	6.2 (157)					1.50 (38)			100	1000	1000	25000
<b>PLT2S-C</b>	7.4 (188)					1.88 (48)			100	1000	1000	10000
<b>PLT2.5S-C</b>	9.8 (249)					2.50 (64)			100	1000	1000	10000
<b>PLT3S-C</b>	11.5 (292)					3.00 (76)			100	1000	1000	10000
<b>PLT4S-C</b>	14.5 (368)					4.00 (102)			100	1000	1000	5000
<b>PLT4.5S-C</b>	15.5 (394)					4.50 (114)			100	1000	1000	5000
<b>PLT5S-C</b>	17.5 (445)					5.00 (127)			100	500	1000	5000

# PANDUIT® Nylon 6.6 Locking Cable Ties (PLT Series)

## Light-Heavy and Heavy Cross Section

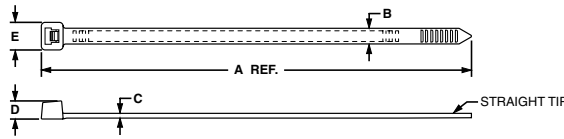

Except PLT5H, 6H, 8H and 13H



Part Number	Length A in. (mm)	Width B in. (mm)	Thickness C in. (mm)	Head Height D in. (mm)	Head Width E in. (mm)	Max. Bundle Dia. in. (mm)	Min. Loop Tensile Strength Lbs. (N)	Recommended PANDUIT® Installation Tool Part No.	Packaging*			
									Std. Pkg. Qty.	Std. Ctn. Qty.	Bulk Pkg. Qty.	Bulk Ctn. Qty.
<b>LIGHT-HEAVY CROSS SECTION</b>												
<b>PLT6LH-L</b>	21.9 (556)	.300 (7.6)	.075 (1.9)	.325 (8.3)	.480 (12.2)	6.00 (152)	120 (534)	GTH, GS4H, GS4EH, PPTEH, ST2EH or STH2	50	500	100	2000
<b>PLT7LH-L</b>	24.7 (627)					7.00 (178)			50	500	100	2000
<b>PLT8LH-L</b>	27.6 (701)					8.00 (203)			50	500	100	2000
<b>PLT9LH-L</b>	30.5 (775)					9.00 (229)			50	500	100	1000
<b>PLT10LH-L</b>	34.3 (871)					10.31 (262)			50	1000	100	1000

<b>HEAVY CROSS SECTION</b>												
<b>PLT2H-L</b>	8.1 (206)	.300 (7.6)	.075 (1.9)	.290 (7.4)	.480 (12.2)	2.00 (51)	120 (534)	GTH, GS4H, GS4EH, PPTEH, ST2EH or STH2	50	500	250	2500
<b>PLT2.5H-L</b>	9.8 (251)					2.50 (64)			50	500	250	2500
<b>PLT3H-L</b>	11.4 (290)					3.00 (76)			50	500	250	2500
<b>PLT4H-L</b>	14.5 (368)					4.00 (102)			50	500	250	2500
<b>PLT5H-L</b>	17.7 (450)	.350 (8.9)	.078 (2.0)	.340 (8.6)	.560 (14.2)	5.00 (127)	175 (778)	GTH, GS4H, GS4EH, PPTEH, ST2EH or STH2	50	500	100	2500
<b>PLT6H-L</b>	20.9 (530)					6.00 (152)			50	500	100	2000
<b>PLT8H-L</b>	30.6 (779)					9.00 (229)			50	500	100	1000
<b>PLT13H-Q</b>	43.3 (1100)					13.00 (330)			25	500	100	500

## PAN-Ty® Locking Lashing Ties



Lashing Ties typically are used on heavy duty jobs such as securing conduit or large cable bundles to permanent structures, indoors or out. Can be used with MCEH mounting clip (see page 16).

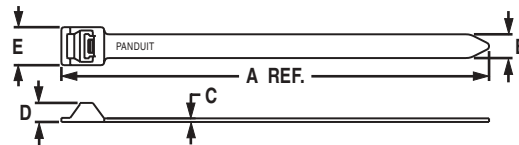

Part Number	Length A in. (mm)	Width B in. (mm)	Thickness C in. (mm)	Head Height D in. (mm)	Head Width E in. (mm)	Max. Bundle Dia. in. (mm)	Min. Loop Tensile Strength Lbs. (N)	Recommended PANDUIT® Installation Tool Part No.	Packaging*			
									Std. Pkg. Qty.	Std. Ctn. Qty.	Bulk Pkg. Qty.	Bulk Ctn. Qty.
<b>EXTRA-HEAVY CROSS SECTION</b>												
<b>PLT2EH-C‡</b>	9.0 (229)	.500 (12.7)	.075 (1.9)	.40 (10.2)	.80 (20.3)	2.00 (51)	250 (1112)	GS4EH, PPTEH or ST2EH	—	—	100	1000
<b>PLT5EH-Q■</b>	20.1 (511)					5.00 (127)			25	250	100	1000
<b>PLT6EH-Q■</b>	22.2 (564)					6.00 (152)			25	250	100	1000
<b>PLT8EH-C‡</b>	28.3 (719)		8.00 (203)			—			—	100	1000	
<b>PLT10EH-C‡</b>	34.2 (869)		10.00 (254)			—			—	100	500	
<b>PLT12EH-C‡</b>	40.1 (1019)		12.00 (305)			—			—	100	500	

\*Order the number of pieces required in multiples of package quantities.  
 For colors and other materials, see pages 24-26.  
 ‡ All part numbers shown in standard package quantities unless denoted by ‡.  
 ■ Available without buckle for applications that do not require mounting.

# PANDUIT® Nylon 6.6 Releasable Cable Ties (PRT Series)

## PAN-TY® Releasable Nylon 6.6 Cable Ties

The extended tab end of releasable cable ties permits easy release and re-use even after the tie has been pulled up snug by hand. Releasable ties are particularly useful in applications where changes are anticipated during development, production or servicing in the field.



To release, grasp the head of the cable tie, deflect release tab and pull the cable tie away from the bundle.

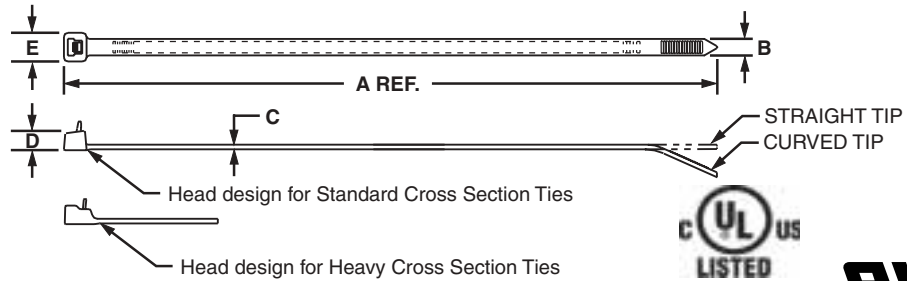

Except Heavy Ties **RAI** US

Part Number	Length A in. (mm)	Width B in. (mm)	Thickness C in. (mm)	Head Height D in. (mm)	Head Width E in. (mm)	Max. Bundle Dia. in. (mm)	Min. Loop Tensile Strength Lbs. (N)	Recommended PANDUIT® Installation Tool Part No.	Packaging*			
									Std. Pkg. Qty.	Std. Ctn. Qty.	Bulk Pkg. Qty.	Bulk Ctn. Qty.

### STANDARD CROSS SECTION

<b>PRT1S-C</b>	4.8 (122)	.190 (4.8)	.052 (1.3)	.219 (5.6)	.316 (8.0)	1.00 (25)	50 (222)	Hand Installed Only	100	1000	1000	10000
<b>PRT1.5S-C</b>	6.3 (160)								100	1000	1000	10000
<b>PRT2S-C</b>	7.4 (188)								100	1000	1000	10000
<b>PRT3S-C</b>	11.5 (292)								100	1000	1000	10000
<b>PRT4S-C</b>	14.5 (368)								100	1000	1000	5000

### HEAVY CROSS SECTION

<b>PRT2H-L</b>	8.4 (213)	.300 (7.6)	.075 (1.9)	.300 (7.6)	.480 (12.2)	2.00 (51)	80 (356)	Hand Installed Only	50	500	250	2500
<b>PRT3H-L</b>	11.4 (290)					3.00 (76)			50	500	250	2500
<b>PRT4H-L</b>	14.5 (368)					4.00 (102)			50	500	250	2500

## PAN-TY® Releasable Lashing Ties — Nylon 6.6

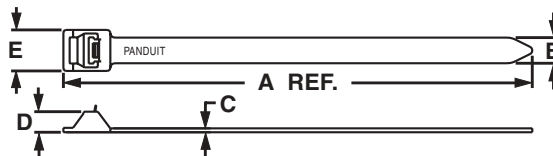

Part Number	Length A in. (mm)	Width B in. (mm)	Thickness C in. (mm)	Head Height D in. (mm)	Head Width E in. (mm)	Max. Bundle Dia. in. (mm)	Min. Loop Tensile Strength Lbs. (N)	Recommended PANDUIT® Installation Tool Part No.	Packaging*			
									Std. Pkg. Qty.	Std. Ctn. Qty.	Bulk Pkg. Qty.	Bulk Ctn. Qty.

### EXTRA-HEAVY CROSS SECTION

<b>PRT2EH-C‡</b>	9.0 (229)	.500 (12.7)	.075 (1.9)	.40 (10.2)	.80 (20.3)	2.00 (51)	250 (1112)	Hand Installed Only	—	—	100	1000
<b>PRT5EH-Q</b>	20.1 (510)					5.00 (127)			25	250	100	1000
<b>PRT6EH-Q</b>	22.2 (564)					6.00 (152)			25	250	100	1000
<b>PRT8EH-C‡</b>	28.3 (719)		8.00 (203)			—			—	100	1000	
<b>PRT10EH-C‡</b>	34.2 (869)		10.00 (254)			—			—	100	500	
<b>PRT12EH-C‡</b>	40.1 (1019)		12.00 (305)			—			—	100	500	



# PANDUIT® Nylon 6.6 Locking Clamp Ties (PLC Series)

## PAN-TY® Nylon 6.6 Clamp Ties

Clamp ties are used to attach a bundle to another surface such as a control panel, wall or ceiling using another fastener. The design allows for bundling before or after screwing clamp in place.

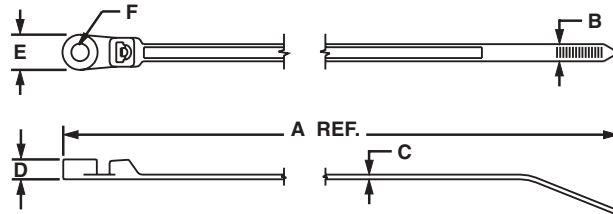

Part Number	Length A in. (mm)	Width B in. (mm)	Thickness C in. (mm)	Boss Height D in. (mm)	Boss Width E in. (mm)	Hole Dia. F in. (mm)	Screw Size (Metric)	Max. Bundle Dia. in. (mm)	Min. Loop Tensile Strength Lbs. (N)	Recommended PANDUIT® Installation Tool Part No.	Packaging*			
											Std. Pkg. Qty.	Std. Ctn. Qty.	Bulk Pkg. Qty.	Bulk Ctn. Qty.
<b>MINIATURE CROSS SECTION</b>														
<b>PLC1M-S4-C</b>	4.3 (110)	.100 (2.5)	.045 (1.2)	.153 (3.9)	.239 (6.1)	.118 (3.0)	#4 (M2.5)	.75 (20)	18 (80)	GTS, GS2B, PTS, PPTS or STS2	100	1000	1000	50000
<b>INTERMEDIATE CROSS SECTION</b>														
<b>PLC1.5I-S8-C</b>	6.1 (156)	.135 (3.4)	.045 (1.2)	.166 (4.2)	.335 (8.5)	.172 (4.4)	#8 (M4)	1.25 (32)	40 (178)	GTS, GS2B, PTS, PPTS or STS2	100	1000	1000	25000
<b>STANDARD CROSS SECTION</b>														
<b>PLC2S-S6-C</b>	7.9 (201)	.190 (4.8)	.047 (1.2)	.160 (4.1)	.373 (9.5)	.145 (3.7)	#6 (M3)	1.84 (47)	50 (222)	GTS, GS2B, GTH, GS4H, PTS, PPTS, STS2 or STH2	100	1000	1000	10000
<b>PLC2S-S10-C</b>	7.9 (201)					#10 (M5)	100				1000	1000	10000	
<b>PLC3S-S10-C</b>	12.0 (305)		.052 (1.3)	.220 (5.6)		.206 (5.2)	#10 (M5)	3.00 (76)			100	1000	1000	5000
<b>PLC4S-S10-C</b>	15.0 (381)		#10 (M5)	4.00 (102)		100	1000	1000			5000			
<b>HEAVY CROSS SECTION</b>														
<b>PLC2H-S25-L</b>	9.0 (228)	.300 (7.6)	.075 (1.9)	.265 (6.7)	.500 (12.7)	.260 (6.6)	1/4 (M6)	2.00 (51)	120 (534)	GTH, GS4H, GS4EH, PPTEH STH2 or ST2EH	50	500	250	2500
<b>PLC4H-S25-L</b>	15.1 (384)							4.00 (102)			50	500	250	2500

\*Order the number of pieces required in multiples of package quantities.  
For colors and other materials, see pages 24-26.  
All part numbers shown in standard package quantities unless denoted by ‡.

# PANDUIT® Nylon 6.6 Marker and Flag Ties (PLF/PLM Series)

## PAN-TY® Nylon 6.6 Marker and Flag Ties

Marker and Flag Ties fasten and identify bundles at the same time. They can be marked with *PANDUIT®* Marker Pens or you can use *PANDUIT®* Custom Hot Stamping Service.

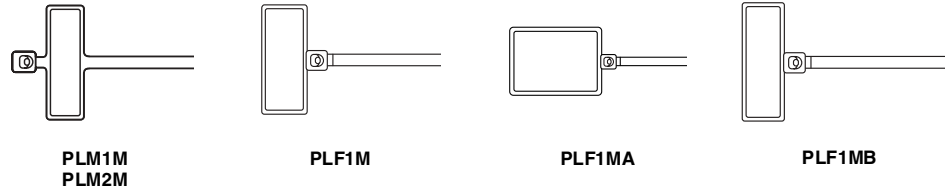
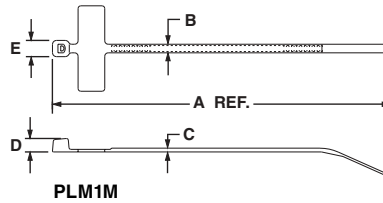
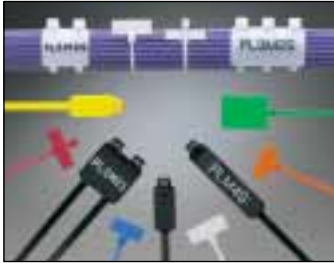

Part Number	Length A in. (mm)	Width B in. (mm)	Thickness C in. (mm)	Head Height D in. (mm)	Head Width E in. (mm)	Write-on Area in. (mm)	Max. Bundle Dia. in. (mm)	Min. Loop Tensile Strength Lbs. (N)	Recommended <i>PANDUIT®</i> Installation Tool Part No.	Packaging*			
										Std. Pkg. Qty.*	Std. Ctn. Qty.	Bulk Pkg. Qty.	Bulk Ctn. Qty.

### MINIATURE CROSS SECTION

<b>PLF1M-C</b>	4.3 (109)	.098 (2.5)	.045 (1.1)	.154 (3.9)	.180 (4.6)	.31 x .75 (7.9 x 19.1)	.87 (22)	18 (80)	GTS, GS2B, PTS, PPTS or STS2	100	1000	1000	25000
<b>PLF1MA-C</b>	5.1 (130)					.76 x 1.04 (19.1 x 26.4)				100	1000	1000	25000
<b>PLF1MB-C</b>	4.0 (101)					.31 x .92 (7.9 x 23.4)				100	1000	1000	25000
<b>PLM1M-C</b>	3.9 (99)					.26 x .95 (6.6 x 24.1)				100	1000	1000	10000
<b>PLM2M-C</b>	8.0 (203)					2.00 (51)				100	1000	1000	10000

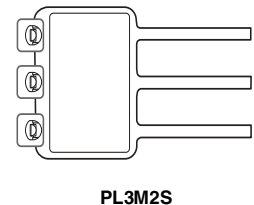
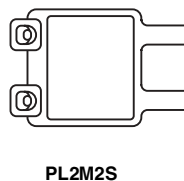
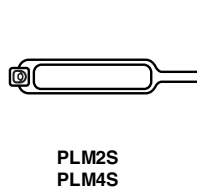

Part Number	Length A in. (mm)	Width B in. (mm)	Thickness C in. (mm)	Head Height D in. (mm)	Head Width E in. (mm)	Write-on Area in. (mm)	Max. Bundle Dia. in. (mm)	Min. Loop Tensile Strength Lbs. (N)	Recommended <i>PANDUIT®</i> Installation Tool Part No.	Packaging*			
										Std. Pkg. Qty.*	Std. Ctn. Qty.	Bulk Pkg. Qty.	Bulk Ctn. Qty.

### STANDARD CROSS SECTION

<b>PLM2S-C</b>	7.4 (188)	.185 (4.7)	.052 (1.3)	.220 (5.6)	.320 (8.1)	.44 x .87 (11.1 x 22.1)	1.75 (45)	50 (222)	GTS, GS2B, GTH, GS4H, PTS, PPTS, STS2 or STH2	100	1000	500	10000	
<b>PLM4S-C</b>	14.6 (371)					.44 x 2.00 (11.1 x 50.8)				4.00 (102)	100	1000	500	5000
<b>PL2M2S-L</b>	7.4 (188)					.87 x 1.07 (22.1 x 27.2)				1.75 (45)	50	500	500	2500
<b>PL3M2S-L</b>	7.4 (188)					.87 x 1.79 (22.1 x 45.5)				1.75 (45)	50	500	500	2500

Marker Ties are also available in weather resistant black nylon for outdoor use. May be marked with *PANDUIT®* PX-10 White Marking Pen found on [page 105](#).

**Custom Hot Stamping Available; See page 52.**

# PANDUIT® Nylon 6.6 Winged Push Mount Ties (PLWP/PRWP Series)

## PAN-TY® Nylon 6.6 Winged Push Mount Ties

Push mount ties are used to attach a cable bundle to a surface such as a flat panel. The anchor is easily pressed into a pre-drilled hole and locks in place. The wings provide constant tension when installed, creating a stable, secure fixture and rattle-free installation.

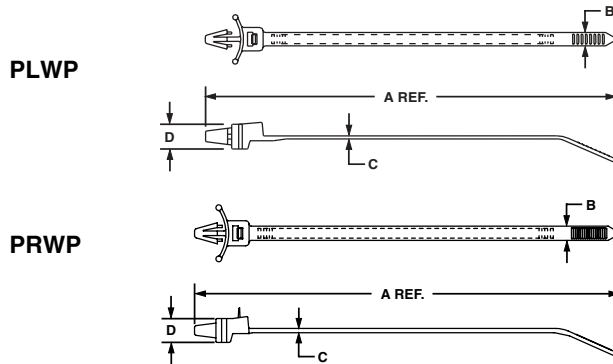

### Winged Nylon 6.6 Push Mount Ties — Locking Style (PLWP)



Part Number	Length A in. (mm)	Width B in. (mm)	Thickness C in. (mm)	Head Height D in. (mm)	Nominal Hole Dia. in. (mm)	Max. Panel Thickness in. (mm)	Max. Bundle Dia. in. (mm)	Min. Loop Tensile Strength Lbs. (N)	Recommended PANDUIT® Installation Tool Part No.	Packaging*			
										Std. Pkg. Qty.	Std. Ctn. Qty.	Bulk Pkg. Qty.	Bulk Ctn. Qty.
<b>MINIATURE CROSS SECTION</b>													
<b>PLWP1M-C</b>	4.3 (109)	.098 (2.5)	.044 (1.1)	.220 (5.6)	.187 (4.7)	.093 (2.4)	.87 (22)	18 (80)	GTS, GS2B, PTS, PPTS or STS2	100	1000	500	5000

### INTERMEDIATE CROSS SECTION

<b>PLWP1.5I-C</b>	6.0 (152)	.135 (3.4)	.045 (1.2)	.280 (7.1)	.187 (4.7)	.093 (2.4)	1.25 (32)	40 (178)	GTS, GS2B, PTS, PPTS or STS2	100	1000	500	5000
-------------------	--------------	---------------	---------------	---------------	---------------	---------------	--------------	-------------	------------------------------------	-----	------	-----	------

### STANDARD CROSS SECTION

<b>PLWP1S-C</b>	5.2 (132)	.190 (4.8)	.052 (1.3)	.370 (9.4)	.252 (6.4)	.105 (2.7)	1.00 (25)	50 (222)	GTS, GS2B, GTH, GS4H, PTS, PPTS, STS2 or STH2	100	1000	500	5000	
<b>PLWP1SA-D‡</b>	5.1 (130)				.093 (2.4)	—				—	500	5000		
<b>PLWP1SB-D‡</b>	5.2 (132)				.157 (4.0)	—	—			500	5000			
<b>PLWP1.5S-D‡</b>	6.8 (173)				.252 (6.4)	.105 (2.7)	1.50 (38)			500	5000			
<b>PLWP1.5SA-D‡</b>	6.7 (170)				.187 (4.7)	.093 (2.4)						—	—	500
<b>PLWP2S-C</b>	7.8 (198)				.252 (6.4)	.105 (2.7)	1.75 (45)			500	5000			
<b>PLWP2SA-D‡</b>	7.7 (196)				.093 (2.4)	—						—	500	5000
<b>PLWP2SB-D‡</b>	7.8 (198)				.157 (4.0)	—						—	500	5000

### HEAVY CROSS SECTION

<b>PLWP2H-TL‡</b>	8.9 (226)	.300 (7.6)	.075 (1.9)	.370 (9.4)	.266 (6.8)	.105 (2.7)	2.00 (51)	120 (534)	GTH, GS4H, STH2 or PPTEH	—	—	250	2500
<b>PLWP3H-TL‡</b>	12.0 (305)						3.00 (76)			—	—	250	2500

### Winged Nylon 6.6 Push Mount Ties — Releasable Style (PRWP)

#### STANDARD CROSS SECTION

<b>PRWP1S-C</b>	5.2 (132)	.190 (4.8)	.052 (1.3)	.370 (9.4)	.266 (6.8)	.105 (2.7)	1.00 (25)	50 (222)	Hand Installed Only	100	1000	500	5000
<b>PRWP1SA-C</b>	5.1 (130)				.093 (2.4)	100				1000	500	5000	
<b>PRWP1SB-D‡</b>	5.2 (132)				.157 (4.0)	—	—			500	5000		
<b>PRWP1.5S-D‡</b>	6.8 (173)				.252 (6.4)	.105 (2.7)	1.50 (38)			500	5000		
<b>PRWP2S-D‡</b>	7.8 (198)				.093 (2.4)	—						—	500

#### HEAVY CROSS SECTION

<b>PRWP2H-TL ‡</b>	8.9 (226)	.300 (7.6)	.075 (1.9)	.370 (9.4)	.266 (6.8)	.105 (2.7)	2.00 (51)	120 (534)	Hand Installed Only	—	—	250	2500
--------------------	--------------	---------------	---------------	---------------	---------------	---------------	--------------	--------------	------------------------	---	---	-----	------

\*Order the number of pieces required in multiples of package quantities.  
For colors and other materials, see pages 24-26.  
All part numbers shown in standard package quantities unless denoted by ‡.

# PANDUIT® Heat Stabilized Nylon 6.6 Push Mount Ties (PLWP/PRLWP Series)

## PAN-TY® Center Mounted Heat Stabilized Nylon 6.6 Winged Push Mount Ties

Center mounted winged push mount cable ties center the bundle on all bundle diameters.

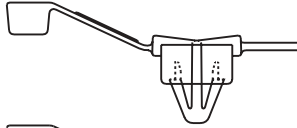
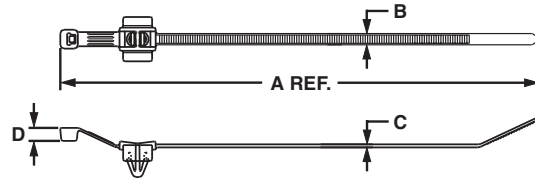

**PLWP30, 40, 50SC** winged push mount cable ties are for normal wire bundles.

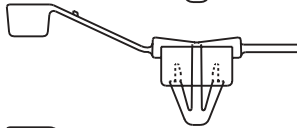

**PLWP40SD** winged push mount cable ties with convoluted tubing bump that prevents lateral and axial movement on convoluted tubing.

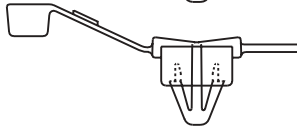

**PLWP50SE** winged push mount cable ties with convoluted tubing bump that prevents lateral movement on convoluted tubing.

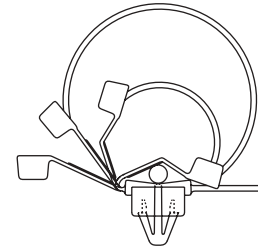

**BUNDLE DIAMETERS**  
from .12" to 1.97"  
(3mm to 50mm)



Part Number	Length A in. (mm)	Width B in. (mm)	Thickness C in. (mm)	Head Height D in. (mm)	Nominal Hole Dia. in. (mm)	Max. Panel Thickness in. (mm)	Max. Bundle Dia. in. (mm)	Min. Loop Tensile Strength Lbs. (N)	Recommended PANDUIT® Installation Tool Part No.	Packaging*			
										Std. Pkg. Qty.	Std. Ctn. Qty.	Bulk Pkg. Qty.	Bulk Ctn. Qty.

### STANDARD CROSS SECTION

<b>PLWP30SC-D30‡</b>	5.8 (147)	.190 (4.8)	.050 (1.3)	.220 (5.6)	.266 (6.8)	.118 (3.0)	1.18 (30)	50 (222)	GTS, GS2B, GTH, GS4H, PTS, PPTS, STS2 or STH2	—	—	500	5000
<b>PLWP40SC-D30‡</b>	7.0 (178)						1.58 (40)			—	—	500	5000
<b>PLWP50SC-D30‡</b>	8.2 (208)						1.97 (50)			—	—	500	5000
<b>PLWP40SD-D30‡</b>	7.0 (178)						1.58 (40)			—	—	500	5000
<b>PLWP50SE-D30‡</b>	8.2 (208)						1.97 (50)			—	—	500	5000

## Ladder Style Heat Stabilized Nylon 6.6 Winged Push Mount Ties

Unique releasable ladder design eliminates the need for multiple clamp sizes.

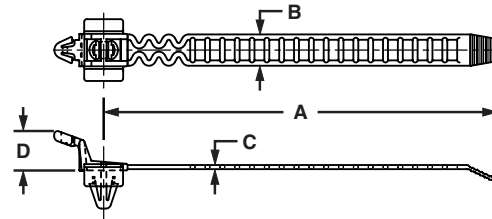

Part Number	Length A in. (mm)	Width B in. (mm)	Thickness C in. (mm)	Head Height D in. (mm)	Nominal Hole Dia. in. (mm)	Max. Panel Thickness in. (mm)	Max. Bundle Dia. in. (mm)	Min. Loop Tensile Strength Lbs. (N)	Recommended PANDUIT® Installation Tool Part No.	Packaging*			
										Std. Pkg. Qty.	Std. Ctn. Qty.	Bulk Pkg. Qty.	Bulk Ctn. Qty.

### STANDARD CROSS SECTION

<b>PRLWP30S-D30‡</b>	4.7 (119)	.380 (9.7)	.050 (1.3)	.470 (12)	.256 (6.5)	.118 (3.0)	1.43 (36)	35 (156)	Hand Installed Only	—	—	500	5000
<b>PRLWP50S-D30‡</b>	7.1 (180)						2.18 (55)			—	—	500	5000

# PANDUIT® Nylon 6.6 Push Mount Ties (PLUP/PLP Series)

## PANDUIT® Umbrella Winged Push Mount Cable Ties



The anchor snaps into a hole in a light gauge metal or plastic panel. No screws or other fasteners required. The umbrella shaped disc stabilizes the anchor and insures a tight, rattle-free fit. In addition, the umbrella disc provides a dust-tight and semi-liquid tight seal against the panel surface. The material is heat stabilized, black Nylon 6.6.

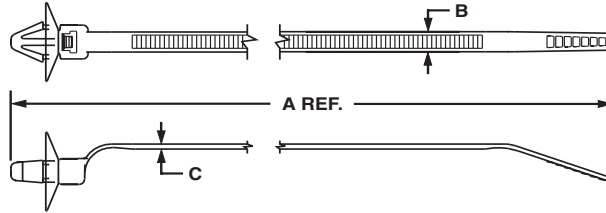

Part Number	A Length in. (mm)	B Width in. (mm)	C Thickness in. (mm)	Nominal Hole Diameter in. (mm)	Max. Panel Thickness in. (mm)	Max. Bundle Diameter in. (mm)	Min. Loop Tensile Strength Lbs. (N)	Recommended PANDUIT® Installation Tool Part No.	Packaging*				
									Std. Pkg. Qty.	Std. Ctn. Qty.	Bulk Pkg. Qty.	Bulk Ctn. Qty.	
<b>STANDARD CROSS SECTION</b>													
<b>PLUP40S-D30‡</b>	7.0 (177)	.190 (4.8)	.047 (1.2)	.266 (6.8)	.050 (1.3)	1.57 (40)	49 (218)	GTS, GS2B, GTH, GS4H, PTH or PPTS	—	—	500	5000	
<b>•PLUP40SE-D30‡</b>									—	—	500	5000	

‡For use with Corrugated Loom Tubing.

## PAN-Ty® Nylon 6.6 Push Mount Ties (Style PLP)

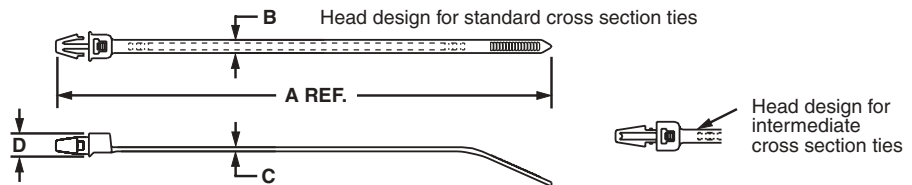

### Economical Push Mount Tie Style



Part Number	A Length in. (mm)	B Width in. (mm)	C Thickness in. (mm)	D Head Height in. (mm)	Nominal Hole Diameter in. (mm)	Max. Panel Thickness in. (mm)	Maximum Bundle Diameter in. (mm)	Min. Loop Tensile Strength Lbs. (N)	Recommended PANDUIT® Installation Tool Part No.	Packaging*			
										Std. Pkg. Qty.	Std. Ctn. Qty.	Bulk Pkg. Qty.	Bulk Ctn. Qty.
<b>PLP1.5I-M‡</b>	6.1 (156)	.135 (3.4)	.045 (1.1)	.236 (6.0)	.187 (4.7)	.090 (2.4)	1.25 (31.8)	40 (178)	GTS, GS2B, PTS, PPTS or STS2	—	—	1000	25000

### INTERMEDIATE CROSS SECTION

<b>PLP1.5I-M‡</b>	6.1 (156)	.135 (3.4)	.045 (1.1)	.236 (6.0)	.187 (4.7)	.090 (2.4)	1.25 (31.8)	40 (178)	GTS, GS2B, PTS, PPTS or STS2	—	—	1000	25000
-------------------	--------------	---------------	---------------	---------------	---------------	---------------	----------------	-------------	------------------------------	---	---	------	-------

### STANDARD CROSS SECTION

<b>PLP1S-C</b>	5.3 (134)	.180 (4.6)	.50 (1.3)	.354 (9.0)	.250 (6.4)	.130 (3.2)	1.00 (25)	50 (222)	GTS, GS2B, GTH, GS4H, PTS, PPTS, STS2 or STH2	100	1000	1000	10000
<b>PLP1.5S-M‡</b>	6.7 (170)						1.50 (38)			—	—	1000	10000
<b>PLP2S-C</b>	7.9 (200)						1.75 (45)			100	1000	1000	10000

\*Order the number of pieces required in multiples of package quantities.  
For colors and other materials, see pages 24-26.  
All part numbers shown in standard package quantities unless denoted by ‡.

# PANDUIT® Weather Resistant Nylon 6.6 Cable Ties (PLT Series)

## PAN-TY® Weather Resistant Nylon Cable Ties

Weather resistant nylon has greater resistance to ultraviolet light which damages natural nylon. Where adverse outdoor conditions exist, see technical/application data section ([pages 64-65](#)) to select proper cable tie material for specific applications.

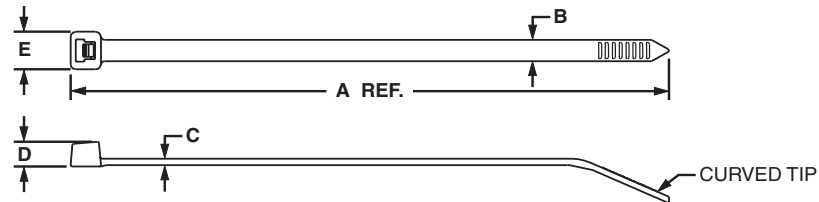

### SUBMINIATURE AND MINIATURE CROSS SECTION



Part Number	Length A in. (mm)	Width B in. (mm)	Thickness C in. (mm)	Head Height D in. (mm)	Head Width E in. (mm)	Max. Bundle Dia. in. (mm)	Min. Loop Tensile Strength Lbs. (N)	Recommended PANDUIT® Installation Tool Part No.	Packaging*			
									Std. Pkg. Qty.	Std. Ctn. Qty.	Bulk Pkg. Qty.	Bulk Ctn. Qty.
<b>PLT.6SM-C0</b>	2.8 (71)	.070 (1.8)	.030 (.8)	.095 (2.4)	.125 (3.2)	.60 (15)	8 (36)	GTS, PTS or STS2	100	1000	1000	50000
<b>PLT1M-C0</b>	3.9 (99)	.098 (2.5)	.043 (1.1)	.154 (3.9)	.180 (4.6)	.87 (22)	18 (80)	GTS, GS2B, PTS, PPTS or STS2	100	1000	1000	50000
<b>PLT1.5M-C0</b>	5.6 (142)								100	1000	1000	50000
<b>PLT2M-C0</b>	8.0 (203)								100	1000	1000	25000

### INTERMEDIATE CROSS SECTION

<b>PLT1.5I-C0</b>	5.6 (142)	.142 (3.6)	.045 (1.1)	.180 (4.6)	.240 (6.1)	1.38 (35)	40 (178)	GTS, GS2B, PTS, PPTS or STS2	100	1000	1000	25000
<b>PLT2I-C0</b>	8.0 (203)					2.00 (51)			100	1000	1000	25000
<b>PLT2.5I-C0</b>	9.7 (246)	.145 (3.7)	.052 (1.3)	.180 (4.6)	.280 (6.6)	2.50 (64)	50 (222)	GTS, GS2B, GTH, GS4H, PTS, PPTS, STS2 or STH2	100	1000	1000	10000
<b>PLT3I-C0</b>	11.4 (290)					3.00 (76)			100	1000	1000	10000
<b>PLT4I-C0</b>	14.5 (368)					4.00 (102)			100	1000	1000	10000

### STANDARD CROSS SECTION

<b>PLT1S-C0</b>	4.8 (122)	.190 (4.8)	.052 (1.3)	.220 (5.6)	.316 (8.0)	1.00 (25)	50 (222)	GTS, GS2B, GTH, GS4H, PTS, PPTS, STS2 or STH2	100	1000	1000	10000
<b>PLT1.5S-C0</b>	6.2 (157)					1.50 (38)			100	1000	1000	10000
<b>PLT2S-C0</b>	7.4 (188)					1.88 (48)			100	1000	1000	10000
<b>PLT2.5S-C0</b>	9.8 (249)					2.50 (64)			100	1000	1000	10000
<b>PLT3S-C0</b>	11.5 (292)					3.00 (76)			100	1000	1000	10000
<b>PLT4S-C0</b>	14.5 (368)					4.00 (102)			100	1000	1000	5000
<b>PLT4.5S-C0</b>	15.5 (394)					4.50 (114)			100	1000	1000	5000
<b>PLT5S-C0</b>	17.5 (445)	5.00 (127)	100	500	1000	5000						

# PANDUIT® Weather Resistant Cable Ties (PLT Series)

## PAN-Ty® Weather Resistant Nylon Cable Ties

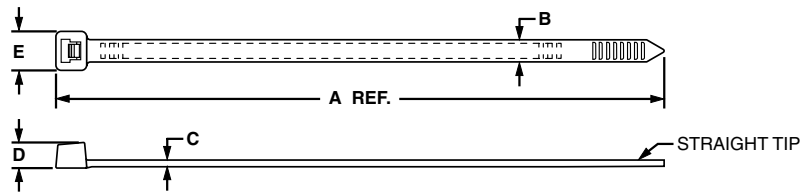

Part Number	Length A in. (mm)	Width B in. (mm)	Thickness C in. (mm)	Head Height D in. (mm)	Head Width E in. (mm)	Max. Bundle Dia. in. (mm)	Min. Loop Tensile Strength Lbs. (N)	Recommended PANDUIT® Installation Tool Part No.	Packaging*			
									Std. Pkg. Qty.	Std. Ctn. Qty.	Bulk Pkg. Qty.	Bulk Ctn. Qty.
<b>LIGHT-HEAVY CROSS SECTION</b>												
PLT6LH-L0	21.9 (556)	.300 (7.6)	.075 (1.9)	.325 (8.3)	.480 (12.2)	6.00 (152)	120 (534)	GTH, GS4H, GS4EH PPTEH or STH2	50	500	100	2000
PLT7LH-L0	24.7 (627)								50	500	100	2000
PLT8LH-L0	27.6 (701)								50	500	100	2000
PLT9LH-L0	30.5 (775)								50	500	100	2000

<b>HEAVY CROSS SECTION</b>												
PLT2H-L0	8.1 (206)	.300 (7.6)	.075 (1.9)	.290 (7.4)	.480 (12.2)	2.00 (51)	120 (534)	GTH, GS4H, GS4EH PPTEH or STH2	50	500	100	1000
PLT2.5H-L0	9.8 (251)								50	500	250	2500
PLT3H-L0	11.4 (290)								50	500	250	2500
PLT4H-L0	14.5 (368)								50	500	250	2500
PLT5H-L0	17.7 (450)	.350 (8.9)	.078 (2.0)	.340 (8.6)	.560 (14.2)	5.00 (127)	175 (778)	GTH, GS4H, GS4EH PPTEH or STH2	50	500	250	2500
PLT6H-L0	20.9 (530)								50	500	250	2000
PLT8H-L0	30.6 (779)								50	500	100	1000
PLT13H-Q0	43.3 (1100)								25	500	100	500

## PAN-Ty® Locking Weather Resistant Nylon Lashing Ties

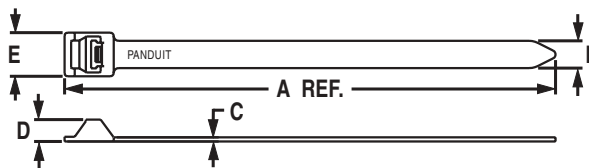

Part Number	Length A in. (mm)	Width B in. (mm)	Thickness C in. (mm)	Head Height D in. (mm)	Head Width E in. (mm)	Max. Bundle Dia. in. (mm)	Min. Loop Tensile Strength Lbs. (N)	Recommended PANDUIT® Installation Tool Part No.	Packaging*			
									Std. Pkg. Qty.	Std. Ctn. Qty.	Bulk Pkg. Qty.	Bulk Ctn. Qty.
<b>EXTRA-HEAVY CROSS SECTION</b>												
PLT2EH-Q0	9.0 (229)	.500 (12.7)	.075 (1.9)	.400 (10.2)	.800 (20.3)	2.00 (51)	250 (1112)	GS4EH PPTEH or STH2	25	250	100	1000
PLT5EH-Q0	20.1 (511)								50	250	100	1000
PLT6EH-Q0	22.2 (564)								25	250	100	1000
PLT8EH-Q0	28.3 (719)		25						250	100	1000	
PLT10EH-Q0	34.2 (869)		25						250	100	500	
PLT12EH-Q0	40.1 (1019)		25						250	100	500	

\*Order the number of pieces required in multiples of package quantities.  
For colors and other materials, see pages 24-26.  
All part numbers shown in standard package quantities unless denoted by ‡

# PANDUIT® Weather Resistant Cable Ties (PRT Series)

## PAN-TY® Releasable Weather Resistant Nylon Lashing Ties

The extended tab end of releasable cable ties permits easy release and reuse even after tie has been pulled up snug by hand. Releasable ties are particularly useful where changes are anticipated during development, production or servicing in the field.

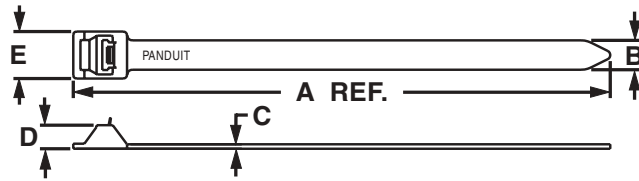

Part Number	Length A in. (mm)	Width B in. (mm)	Thickness C in. (mm)	Head Height D in. (mm)	Head Width E in. (mm)	Max. Bundle Dia. in. (mm)	Min. Loop Tensile Strength Lbs. (N)	Recommended PANDUIT® Installation Tool Part No.	Packaging*					
									Std. Pkg. Qty.	Std. Ctn. Qty.	Bulk Pkg. Qty.	Bulk Ctn. Qty.		
<b>EXTRA-HEAVY CROSS SECTION</b>														
<b>PRT2EH-Q0</b>	9.0 (229)	.500 (12.7)	.075 (1.9)	.400 (10.2)	.800 (20.3)	2.00 (51)	250 (1112)	Hand Installed Only	25	250	100	1000		
<b>PRT5EH-Q0</b>	20.1 (510)								25	250	100	1000		
<b>PRT6EH-Q0</b>	22.2 (564)								25	250	100	1000		
<b>PRT8EH-Q0</b>	28.3 (719)		25						250	100	1000			
<b>PRT10EH-Q0</b>	34.2 (869)		25						250	100	500			
<b>PRT12EH-Q0</b>	40.1 (1019)		25						250	100	500			
			.085 (2.2)			8.00 (203)								
						10.00 (254)								
						12.00 (305)								

## Lashing Tie Mounting Clip

Converts PANDUIT® PAN-TY® Lashing Ties into clamps. Easily snaps in place for a secure clamp. Used with Lashing Ties (see pages 7, 8, 15 and above).

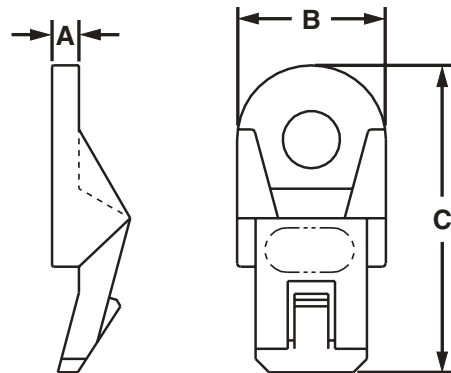
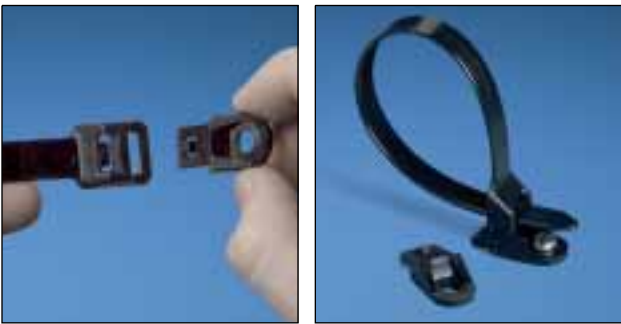

Part Number	Dimensions in. (mm)			Material	Color	Where Used	Mounting Method	Packaging*					
	Height A in. (mm)	Width B in. (mm)	Length C in. (mm)					Std. Pkg. Qty.	Std. Ctn. Qty.	Bulk Pkg. Qty.	Bulk Ctn. Qty.		
<b>MCEH-S25-C0</b>	.13 (3.3)	.67 (17.0)	1.38 (35)	Weather Resistant Nylon 6.6	Black	Outdoors or Indoors	1/4" (M6) screw (except flathead)	—	—	100	1000		





# PANDUIT® Weather Resistant Cable Ties (PRT Series)

## Releasable Cable Ties (PRT Series)

The extended tab end of releasable cable ties permits easy release and reuse even after tie has been pulled up snug by hand. Releasable ties are particularly useful where changes are anticipated during development, production or servicing in the field.

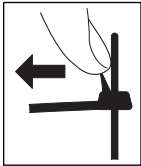

To release, grasp the head of the cable tie, deflect release tab and pull the cable tie away from the bundle.

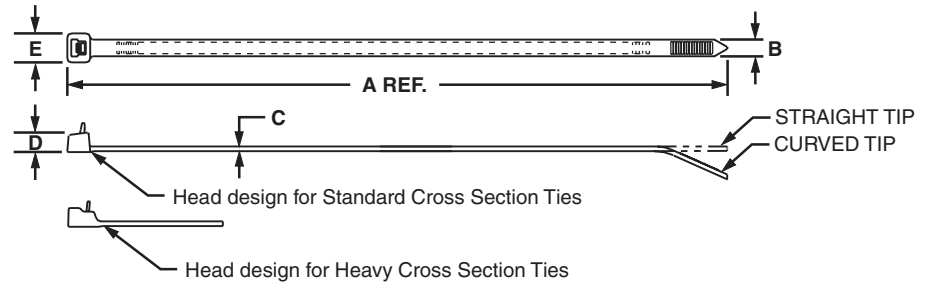

Part Number	Cross Section	Length A in. (mm)	Width B in. (mm)	Thickness C in. (mm)	Head Height D in. (mm)	Head Width E in. (mm)	Max. Bundle Dia. in. (mm)	Min. Loop Tensile Strength Lbs. (N)	Recommended PANDUIT® Installation Tool Part No.	Packaging*			
										Std. Pkg. Qty.	Std. Ctn. Qty.	Bulk Pkg. Qty.	Bulk Ctn. Qty.
<b>STANDARD CROSS SECTION</b>													
PRT1S-C0	Std.	4.8 (122)	.190 (4.8)	.052 (1.3)	.219 (5.6)	.316 (8.0)	1.00 (25)	50 (222)	Hand Installed Only	100	1000	100	10000
PRT1.5S-C0		6.3 (160)								100	1000	100	10000
PRT2S-C0		7.4 (188)								100	1000	100	10000
PRT3S-C0		11.5 (292)								100	1000	100	10000
PRT4S-C0		14.5 (368)								100	1000	100	5000
<b>HEAVY CROSS SECTION</b>													
PRT2H-L0	Hvy.	8.4 (213)	.300 (7.6)	.075 (1.9)	.300 (7.6)	.480 (12.2)	2.00 (51)	80 (356)	Hand Installed Only	50	500	250	2500
PRT3H-L0		11.4 (290)								50	500	250	2500
PRT4H-L0		14.5 (368)								50	500	250	2500

\*Order the number of pieces required in multiples of package quantities.  
 For colors and other materials, see pages 24-26.  
 All part numbers shown in standard package quantities unless denoted by ‡

# PANDUIT® Weather Resistant Nylon 6.6 Clamp Ties (PLC Series)

## PAN-TY® Weather Resistant Nylon Clamp Ties

Clamps are used to attach a bundle to another surface such as a control panel, wall or ceiling using another fastener. The design allows for bundling before or after screwing clamp in place.

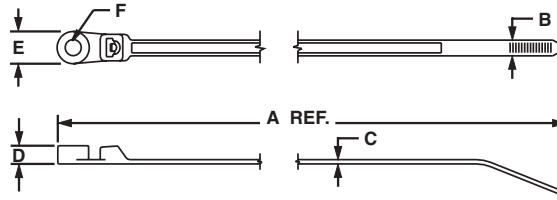

Part Number	Length A in. (mm)	Width B in. (mm)	Thickness C in. (mm)	Boss Height D in. (mm)	Boss Width E in. (mm)	Nominal Hole Dia. F in. (mm)	Screw Size	Max. Bundle Dia. in. (mm)	Min. Loop Tensile Strength Lbs. (N)	Recommended PANDUIT® Installation Tool Part No.	Packaging*			
											Std. Pkg. Qty.	Std. Ctn. Qty.	Bulk Pkg. Qty.	Bulk Ctn. Qty.

### MINIATURE CROSS SECTION

<b>PLC1M-S4-C0</b>	4.3 (110)	.100 (2.5)	.045 (1.2)	.153 (3.9)	.239 (6.1)	.118 (3.0)	#4 (M2.5)	.75 (20)	18 (80)	GTS, GS2B, PTS, PPTS or STS2	100	1000	1000	50000
--------------------	--------------	---------------	---------------	---------------	---------------	---------------	--------------	-------------	------------	------------------------------	-----	------	------	-------

### INTERMEDIATE CROSS SECTION

<b>PLC1.5I-S8-C0</b>	6.1 (156)	.135 (3.4)	.045 (1.2)	.166 (4.2)	.335 (8.5)	.172 (4.4)	#8 (M4)	1.25 (32)	40 (178)	GTS, GS2B, PTS, PPTS or STS2	100	1000	1000	25000
----------------------	--------------	---------------	---------------	---------------	---------------	---------------	------------	--------------	-------------	------------------------------	-----	------	------	-------

### STANDARD CROSS SECTION

<b>PLC2S-S6-C0</b>	7.9 (201)	.190 (4.8)	.047 (1.2)	.160 (4.1)	.390 (9.5)	.145 (3.7)	#6 (M3)	1.84 (47)	50 (222)	GTS, GS2B, GTH, GS4H, PTS, PPTS, STS2 or STH2	100	1000	1000	10000
<b>PLC2S-S10-C0</b>	100										1000	1000	10000	
<b>PLC3S-S10-C0</b>	12.0 (305)										100	1000	1000	5000
<b>PLC4S-S10-C0</b>	15.0 (381)										100	1000	1000	5000

### HEAVY CROSS SECTION

<b>PLC2H-S25-TL0‡</b>	9.0 (228)	.300 (7.6)	.075 (1.9)	.265 (6.7)	.500 (12.7)	.260 (6.6)	1/4 (M6)	2.00 (51)	120 (534)	GTH, GS4H, GS4EH, PPTEH or STH2	—	—	250	2500
<b>PLC4H-S25-L0</b>	15.1 (384)										50	500	250	2500

### NATURAL POLYPROPYLENE CABLE TIES (Refer to drawing on page 19)

Part Number	Length A in. (mm)	Width B in. (mm)	Thickness C in. (mm)	Head Height D in. (mm)	Head Width E in. (mm)	Max. Bundle Dia. in. (mm)	Min. Loop Tensile Strength Lbs. (N)	Recommended PANDUIT® Installation Tool Part No.	Tool Setting' (except STS2/STH2)	Packaging*			
										Std. Pkg. Qty.	Std. Ctn. Qty.	Bulk Pkg. Qty.	Bulk Ctn. Qty.

### MINIATURE CROSS SECTION

<b>PLT1M-M109</b>	3.9 (99)	.098 (2.5)	.043 (1.1)	.154 (3.9)	.180 (4.6)	.87 (22)	11 (49)	GTS, GS2B, PTS, PPTS or STS2	2	—	—	1000	50000
-------------------	-------------	---------------	---------------	---------------	---------------	-------------	------------	------------------------------	---	---	---	------	-------

### INTERMEDIATE CROSS SECTION

<b>PLT1.5I-M109</b>	5.6 (142)	.142 (3.6)	.045 (1.2)	.180 (4.6)	.240 (6.1)	1.38 (35)	18 (80)	GTS, GS2B, PTS, PPTS or STS2	3	—	—	1000	25000
---------------------	--------------	---------------	---------------	---------------	---------------	--------------	------------	------------------------------	---	---	---	------	-------

### STANDARD CROSS SECTION

<b>PLT2S-M109</b>	7.4 (188)	.190 (4.8)	.052 (1.3)	.220 (5.6)	.316 (8.0)	1.88 (48)	30 (133)	GTS, GS2B, GTH, GS4H, PTS, PPTS, STS2 or STH2	5 (GTS, GS2B, PTS, PPTS) 2 (GTH, GS4H)	—	—	1000	10000
<b>PLT3S-M109</b>	11.5 (292)									—	—	1000	10000
<b>PLT4S-M109</b>	14.5 (368)									—	—	1000	5000

### HEAVY CROSS SECTION

<b>PLT2H-TL109</b>	8.1 (206)	.300 (7.6)	.075 (1.9)	.290 (7.4)	.480 (12.2)	2.00 (51)	50 (222)	GTH, GS4H, PPTEH or STH2	5	—	—	250	2500
<b>PLT3H-TL109</b>	11.4 (290)									—	—	250	2500
<b>PLT4H-TL109</b>	14.5 (368)									—	—	250	2500

NOTE 1: For best results, use tool tensions at the low end of the adjustment range, i.e. Std. Cable Ties installed at tool setting 5 to arrive at optimum installation tension.

# PANDUIT® Polypropylene Cable Ties (PLT / PRT Series)

## PAN-Ty® Weather Resistant Polypropylene Cable Ties

For chemical resistance in outdoor applications that are unsuitable for nylon and that do not require high loop tensile strengths. Color is black.

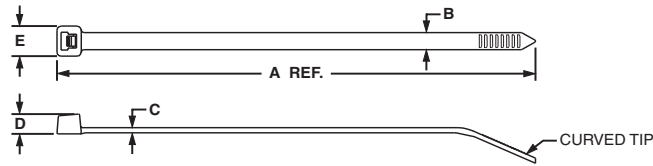

Part Number	Length A in. (mm)	Width B in. (mm)	Thickness C in. (mm)	Head Height D in. (mm)	Head Width E in. (mm)	Max. Bundle Dia. in. (mm)	Min. Loop Tensile Strength Lbs. (N)	Recommended PANDUIT® Installation Tool Part No.	Tool Setting¹ (except STS2/ STH2)	Packaging*			
										Std. Pkg. Qty.	Std. Ctn. Qty.	Bulk Pkg. Qty.	Bulk Ctn. Qty.
<b>MINIATURE CROSS SECTION</b>													
<b>PLT1M-M100</b>	3.9 (99)	.098 (2.5)	.043 (1.1)	.154 (3.9)	.180 (4.6)	.87 (22)	11 (49)	GTS, GS2B, PTS, PPTS or STS2	2	—	—	1000	5000
<b>INTERMEDIATE CROSS SECTION</b>													
<b>PLT1.5I-M100</b>	5.6 (142)	.142 (3.6)	.045 (1.1)	.180 (4.6)	.240 (6.1)	1.38 (35)	18 (80)	GTS, GS2B, PTS, PPTS or STS2	3	—	—	1000	2500
<b>STANDARD CROSS SECTION</b>													
<b>PLT2S-M100</b>	7.4 (188)	.190 (4.8)	.052 (1.3)	.220 (5.6)	.316 (8.0)	1.88 (48)	30 (133)	GTS, GS2B, GTH, GS4H, PTS, PPTS, STS2 or STH2	5 (GTS, GS2B, PTS, PPTS)	—	—	1000	10000
<b>PLT3S-M100</b>	11.5 (292)				.337 (8.6)	3.00 (76)			—	—	1000	10000	
<b>PLT4S-M100</b>	14.5 (368)				4.00 (102)	2 (GTH, GS4H)			—	—	1000	5000	
<b>HEAVY CROSS SECTION</b>													
<b>PLT2H-TL100</b>	8.1 (206)	.300 (7.6)	.075 (1.9)	.290 (7.4)	.480 (12.2)	2.00 (51)	50 (222)	GTH, GS4H, PPTHEH or STH2	5	—	—	250	2500
<b>PLT3H-TL100</b>	11.4 (290)					3.00 (76)				—	—	250	2500
<b>PLT4H-TL100</b>	14.5 (368)					4.00 (102)				—	—	250	2500

NOTE 1: For best results, use tool tensions at the low end of the adjustment range, i.e. Std. Cable Ties installed at tool setting 5 to arrive at optimum installation tension.

## PAN-Ty® Releasable Polypropylene Cable Ties

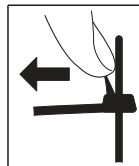

To release, grasp the head of the cable tie, deflect release tab and pull the cable tie away from the bundle.

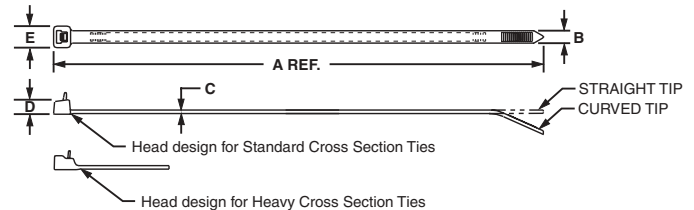

Part Number	Length A in. (mm)	Width B in. (mm)	Thickness C in. (mm)	Head Height D in. (mm)	Head Width E in. (mm)	Max. Bundle Dia. in. (mm)	Min. Loop Tensile Strength Lbs. (N)	Recommended PANDUIT® Installation Tool Part. No.	Packaging*				
									Std. Pkg. Qty.	Std. Ctn. Qty.	Bulk Pkg. Qty.	Bulk Ctn. Qty.	
<b>EXTRA-HEAVY CROSS SECTION — WEATHER RESISTANT POLYPROPYLENE</b>													
<b>PRT5EH-C100</b>	20.1 (510)	.500 (12.7)	.075 (1.9)	.400 (10.2)	.800 (20.3)	5.00 (127)	90 (400)	Hand Installed		100	1000	—	—
<b>PRT6EH-C100</b>	22.2 (564)					6.00 (152)				100	1000	—	—

¹Order the number of pieces required in multiples of package quantities.  
All part numbers shown in standard package quantities unless denoted by ‡

# PANDUIT® Flame Retardant Nylon 6.6 Cable Ties

## PAN-TY® Flame Retardant Nylon 6.6 Cable Ties and Marker Ties

- Flame Retardant Nylon 6.6 meets the requirements of UL94V-0
- Can be used with flame retardant cable tie mounts (see pages 86 and 89)

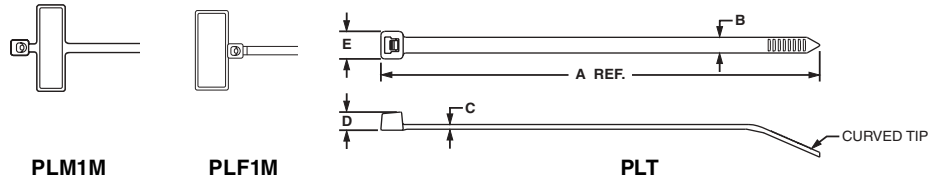
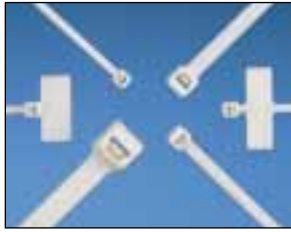

Part Number	Length A in. (mm)	Width B in. (mm)	Thickness C in. (mm)	Head Height D in. (mm)	Head Width E in. (mm)	Marker Write-on Area in. (mm)	Max. Bundle Dia. in. (mm)	Min. Loop Tensile Strength Lbs. (N)	Recommended PANDUIT® Installation Tool Part No.	Packaging*			
										Std. Pkg. Qty.	Std. Ctn. Qty.	Bulk Pkg. Qty.	Bulk Ctn. Qty.
<b>MINIATURE CROSS SECTION</b>													
<b>PLF1M-M69‡</b>	4.3 (109)	.098 (2.5)	.045 (1.1)	.154 (3.9)	.180 (4.6)	.31 x .75 (7.9 x 19.1)	.87 (22)	18 (80)	GTS, GS2B, PTS, PPTS or STS2	—	—	1000	25000
<b>PLM1 M-M69‡</b>	3.9 (99)		.035 (.9)			.26 x .95 (6.6 x 24.1)	.75 (20)			—	—	1000	25000
<b>PLT1M-M69‡</b>	4.0 (102)		.043 (1.1)		.188 (4.8)	—	.87 (22)			—	—	1000	25000
<b>PLT2M-M69‡</b>	8.0 (203)		2.00 (51)				—			—	1000	25000	
<b>INTERMEDIATE CROSS SECTION</b>													
<b>PLT1.5I-M69‡</b>	5.6 (142)	.142 (3.6)	.044 (1.1)	.177 (4.5)	.239 (6.1)	—	1.38 (35)	40 (178)	GTS, GS2B, PTS, PPTS or STS2	—	—	1000	25000
<b>PLT2I-M69‡</b>	8.0 (203)	.142 (3.6)					2.00 (51)			—	1000	25000	
<b>STANDARD CROSS SECTION</b>													
<b>PLT2S-M69‡</b>	7.4 (188)	.190 (4.8)	.052 (1.3)	.220 (5.6)	.320 (8.1)	—	1.88 (48)	50 (222)	GTS, GS2B, GTH, GS4H, PTS, PPTS, STS2 or STH2	—	—	1000	10000
<b>PLT4S-M69‡</b>	14.5 (368)		.052 (1.3)				.337 (8.6)			4.00 (102)	—	1000	5000
<b>HEAVY CROSS SECTION</b>													
<b>PLT4H-TL69‡</b>	14.6 (371)	.300 (7.6)	.075 (1.9)	.290 (7.4)	.480 (12.2)	—	4.00 (102)	120 (534)	GTH, GS4H, GS4EH, PPTEH or STH2	—	—	250	2500

# PANDUIT® Weather Resistant Nylon 12 Cable Ties

## PAN-TY® Weather Resistant Nylon 12 Cable Ties

- For high moisture, corrosive environments and low temperatures
- For indoor use or weather resistant applications

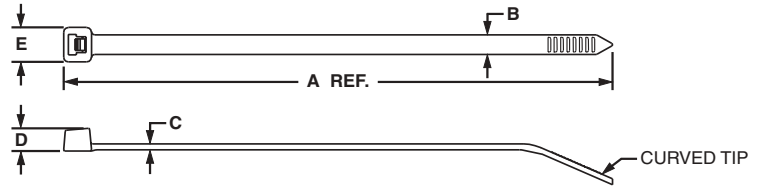

Part Number	Length A in. (mm)	Width B in. (mm)	Thickness C in. (mm)	Head Height D in. (mm)	Head Width E in. (mm)	Max. Bundle Dia. in. (mm)	Min. Loop Tensile Strength Lbs. (N)	Recommended PANDUIT® Installation Tool Part No.	Packaging*			
									Std. Pkg. Qty.	Std. Ctn. Qty.	Bulk Pkg. Qty.	Bulk Ctn. Qty.
<b>INTERMEDIATE CROSS SECTION</b>												
<b>PLT1.5I-M120‡</b>	5.6 (142)	.142 (3.6)	.045 (1.1)	.180 (4.6)	.240 (6.1)	1.38 (35)	25 (111)	GTS, GS2B, PTS, PPTS or STS2	—	—	1000	25000
<b>STANDARD CROSS SECTION</b>												
<b>PLT2S-M120‡</b>	7.4 (188)	.190 (4.8)	.052 (1.3)	.220 (5.6)	.316 (8.0)	1.88 (48)	40 (178)	GTS, GS2B, GTH, GS4H, PTS, PPTS, STS2 or STH2	—	—	1000	10000
<b>PLT4S-M120‡</b>	14.5 (368)				.337 (8.6)	4.00 (102)			—	—	1000	5000
<b>LIGHT-HEAVY CROSS SECTION</b>												
<b>PLT8LH-C120‡</b>	27.6 (701)	.300 (7.6)	.075 (1.9)	.290 (7.4)	.480 (12.2)	8.00 (203)	90 (400)	GTH, GS4H, GS4EH, PPTEH or STH2	—	—	100	2000
<b>HEAVY CROSS SECTION</b>												
<b>PLT4H-TL120‡</b>	14.5 (368)	.300 (7.6)	.075 (1.9)	.290 (7.4)	.480 (12.2)	4.00 (102)	90 (400)	GTH, GS4H, GS4EH, PPTEH or STH2	—	—	250	2500

\*Order the number of pieces required in multiples of packaging quantities.  
All part numbers shown in standard package quantities unless denoted by ‡.

# PANDUIT® HALAR\*\* and TEFZEL\*\*\* Cable Ties

## PAN-TY® HALAR\*\* Fluoropolymer Cable Ties



HALAR\*\* Cable Ties are UL Listed and UL Recognized as: Suitable for use in Air Handling Spaces per NEC, Section 300-22 (c) and (d). Many inspectors look for the distinctive maroon color. HALAR\*\* cable ties have a low smoke density rating and an excellent flammability rating of UL94V-0. Other applications include nuclear plants, chemical environments, telecommunications equipment, aerospace, high and low temperature environments.

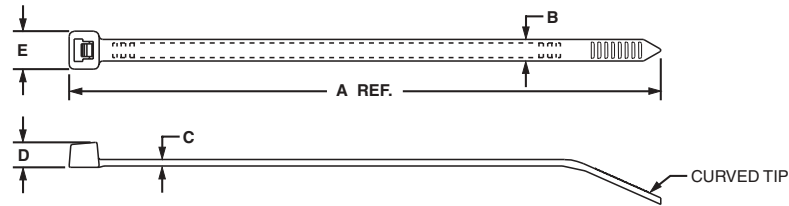

Part Number	Length A in. (mm)	Width B in. (mm)	Thickness C in. (mm)	Head Height D in. (mm)	Head Width E in. (mm)	Max. Bundle Dia. in. (mm)	Min. Loop Tensile Strength Lbs. (N)	Recommended PANDUIT® Installation Tool Part No.	Packaging*			
									Std. Pkg. Qty.	Std. Ctn. Qty.	Bulk Pkg. Qty.	Bulk Ctn. Qty.

### MINIATURE CROSS SECTION

<b>PLT1M-C702</b>	4.0 (102)	.098 (2.5)	.043 (1.1)	.186 (4.7)	.188 (4.8)	.87 (22)	18 (80)	GTS, GS2B, PTS, PPTS or STS2	100	1000	1000	25000
-------------------	--------------	---------------	---------------	---------------	---------------	-------------	------------	------------------------------	-----	------	------	-------

### STANDARD CROSS SECTION

<b>PLT2S-C702</b>	7.4 (188)	.190 (4.8)	.055 (1.4)	.240 (6.1)	.320 (8.1)	1.88 (48)	50 (222)	GTS, GS2B, GTH, GS4H, PTS, PPTS, STS2 or STH2	100	1000	1000	10000
<b>PLT3S-C702</b>	11.6 (295)		.059 (1.5)			3.00 (76)			100	1000	1000	5000

\*\*HALAR is a registered trademark of Solvay Solexis, Inc.

## PAN-TY® TEFZEL\*\*\* Fluoropolymer Cable Ties



TEFZEL\*\*\* cable ties are ideal for applications requiring resistance to environmental stresses such as chemical attack, gamma radiation, ultraviolet radiation and extreme temperatures. In addition, TEFZEL\*\*\* has a UL Flammability rating of UL94V-0. TEFZEL\*\*\* ties have a distinctive aqua blue color.

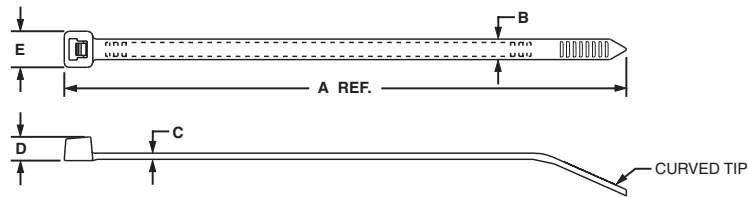

Part Number	Length A in. (mm)	Width B in. (mm)	Thickness C in. (mm)	Head Height D in. (mm)	Head Width E in. (mm)	Max. Bundle Dia. in. (mm)	Min. Loop Tensile Strength Lbs. (N)	Recommended PANDUIT® Installation Tool Part No.	Packaging*			
									Std. Pkg. Qty.	Std. Ctn. Qty.	Bulk Pkg. Qty.	Bulk Ctn. Qty.

### MINIATURE CROSS SECTION

<b>PLT1M-C76</b>	4.0 (102)	.098 (2.5)	.043 (1.1)	.186 (4.7)	.188 (4.8)	.87 (22)	18 (80)	GTS, GS2B, PTS, PPTS or STS2	100	1000	1000	25000
------------------	--------------	---------------	---------------	---------------	---------------	-------------	------------	------------------------------	-----	------	------	-------

### INTERMEDIATE CROSS SECTION

<b>PLT2I-C76</b>	8.0 (203)	.135 (3.4)	.045 (1.1)	.180 (4.6)	.240 (6.1)	2.00 (51)	25 (111)	GTS, GS2B, PTS, PPTS or STS2	100	1000	1000	10000
------------------	--------------	---------------	---------------	---------------	---------------	--------------	-------------	------------------------------	-----	------	------	-------

### STANDARD CROSS SECTION

<b>PLT2S-C76</b>	7.4 (188)	.190 (4.8)	.055 (1.4)	.240 (6.1)	.320 (8.1)	1.88 (48)	50 (222)	GTS, GS2B, GTH, GS4H, PTS, PPTS, STS2 or STH2	100	1000	1000	10000
<b>PLT3S-C76</b>	11.6 (295)		3.00 (76)			100			1000	1000	5000	
<b>PLT4S-C76</b>	14.6 (371)		4.00 (102)			100			1000	1000	5000	

### HEAVY CROSS SECTION

<b>PLT3H-L76</b>	11.5 (292)	.300 (7.6)	.075 (1.9)	.360 (9.1)	.480 (12.2)	3.00 (78)	120 (534)	GTH, GS4H, GS4EH, PPTEH or STH2	50	500	250	2500
<b>PLT4H-L76</b>	14.6 (371)					4.00 (102)			50	500	250	2500

\*\*\*TEFZEL is a registered trademark of E. I. DuPont de Nemours Co.

\*Order the number of pieces required in multiples of package quantities. All part numbers shown in standard package quantities unless denoted by †.

## PAN-TY® Nylon 6.6 Fluorescent Ties

Designed for packaging and color-coding applications. Ties are offered in four “hot” colors: Orange, Yellow, Green and Pink.

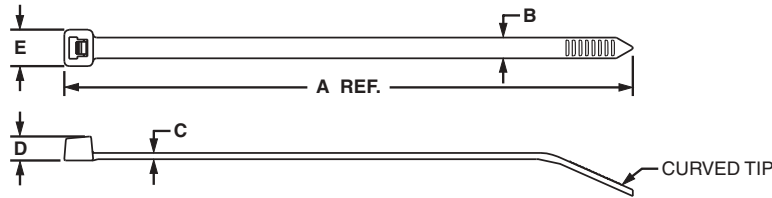

Part Number	Color	Length A in. (mm)	Width B in. (mm)	Thickness C in. (mm)	Head Height D in. (mm)	Head Width E in. (mm)	Max. Bundle Dia. in. (mm)	Min. Loop Tensile Strength Lbs. (N)	Recommended PANDUIT® Installation Tool Part No.	Packaging*			
										Std. Pkg. Qty.	Std. Ctn. Qty.	Bulk Pkg. Qty.	Bulk Ctn. Qty.

### MINIATURE CROSS SECTION

PLT1M-M53	Orange	3.9 (99)	.098 (2.5)	.043 (1.1)	.154 (3.9)	.180 (4.6)	.87 (22)	18 (80)	GTS, GTH, GS2B, PTS, PPTS or STS2	—	—	1000	50000
PLT1M-M54	Yellow									—	—	1000	50000
PLT1M-M55	Green									—	—	1000	50000
PLT1M-M59	Pink									—	—	1000	50000

### INTERMEDIATE CROSS SECTION

PLT2I-M53	Orange	8.0 (203)	.142 (3.6)	.045 (1.1)	.180 (4.6)	.240 (6.1)	2.00 (51)	30 (133)	GTS, GTH, GS2B, PTS, PPTS or STS2	—	—	1000	25000
PLT2I-M54	Yellow									—	—	1000	25000
PLT2I-M55	Green									—	—	1000	25000
PLT2I-M59	Pink									—	—	1000	25000

### STANDARD CROSS SECTION

PLT2S-M53	Orange	7.4 (188)	.190 (4.8)	.052 (1.3)	.220 (5.6)	.316 (8.0)	1.88 (48)	50 (222)	GTS, GS2B, GTH, GS4H, PTS, PPTS, STS2 or STH2	—	—	1000	10000					
PLT2S-M54	Yellow									—	—	1000	10000					
PLT2S-M55	Green									—	—	1000	10000					
PLT2S-M59	Pink									—	—	1000	10000					
PLT3S-M53	Orange	11.5 (292)				.190 (4.8)	.052 (1.3)			.220 (5.6)	.337 (8.6)	3.00 (76)	50 (222)	GTS, GS2B, GTH, GS4H, PTS, PPTS, STS2 or STH2	—	—	1000	10000
PLT3S-M54	Yellow														—	—	1000	10000
PLT3S-M55	Green														—	—	1000	10000
PLT3S-M59	Pink														—	—	1000	10000

\*Order the number of pieces required in multiples of package quantities.  
All part numbers shown in standard package quantities unless denoted by ‡.

# PANDUIT® Part Number Suffix Codes for All PAN-TY® Cable Ties

## Part Number System (Example of PLT2S-C)

PLT                      2                      S                      —                      C

### Part Description:

P = PANDUIT®  
(at beginning of P/N)  
L = Locking  
T = Tie  
C = Clamp  
F = Flag  
M = Marker  
R = Releasable  
W = Wing  
P = Push Mount  
U = Umbrella

### Size:

Approximate  
Maximum Bundle  
Diameter in Inches

### Cross Section:

SM = Subminiature  
M = Miniature  
I = Intermediate  
S = Standard  
LH = Light-Heavy  
H = Heavy  
EH = Extra-Heavy

### Screw Hole Size: (Clamp Ties Only)

-S4 = #4 (M2.5)  
-S6 = #6 (M3)  
-S8 = #8 (M4)  
-S10 = #10 (M5)  
-S25 = 1/4 (M6)

### Package Size:

Q = 25  
L = 50  
C = 100  
TL = 250  
D = 500  
M = 1000  
XMR = 2 reels/5000 ea.

### Color:

See Material/Color  
chart. Not all ties  
available in all colors.

## Material/Color Chart

Material/Color	PANDUIT® Suffix*	Mil Spec Suffix**
Nylon 6.6 — Natural (See Note)	✓	9
Weather Resistant Nylon 6.6 — Black	0	N/A
Weather Resistant Nylon 6.6 — Black (meets MIL Spec.)	00	0
Nylon 6.6 — Brown	1	1
Nylon 6.6 — Red	2	2
Nylon 6.6 — Orange	3	3
Nylon 6.6 — Yellow	4	4
Nylon 6.6 — Green	5	5
Nylon 6.6 — Blue	6	6
Nylon 6.6 — Purple	7	7
Nylon 6.6 — Gray	8	8
Nylon 6.6 — White	10	N/A
Nylon 6.6 — Telephone Gray	14	N/A
Nylon 6.6 — Black	20	N/A

Material/Color	PANDUIT® Suffix*	Mil Spec Suffix**
Heat Stabilized Nylon 6.6 — Black	30	N/A
Heat Stabilized Nylon 6.6 — Natural	39	N/A
Nylon 6.6 — Fluorescent Orange	53	N/A
Nylon 6.6 — Fluorescent Yellow	54	N/A
Nylon 6.6 — Fluorescent Green	55	N/A
Nylon 6.6 — Fluorescent Pink	59	N/A
Flame Retardant Nylon 6.6 — Black	60	N/A
Flame Retardant Nylon 6.6 — Ivory	69	N/A
TEFZEL*** — Aqua Blue	76	N/A
Weather Resistant Polypropylene — Black	100	N/A
Natural Polypropylene — Green	109	N/A
Nylon 12 — Black	120	N/A
Heat Stabilized Weather Resistant Nylon 6.6 — Black	300	N/A
HALAR**** — Maroon	702	N/A

\*NOTE: ✓ designates PANDUIT® standard Natural Nylon 6.6 color/material. No suffix required in part number.

\*\*NOTE: MIL SPEC Color (suffix) per AS33671 (Formerly MS3367) and SAE AS33681 (Formerly MS3368).

\*\*\*TEFZEL is a registered trademark of E. I. DuPont de Nemours Co.

\*\*\*\*HALAR is a registered trademark of Solvay Solexis, Inc.

Standard Packaging			Bulk Packaging		
Part Number	Natural Nylon 6.6	Available Color/ Material (Suffix)	Part Number	Natural Nylon 6.6	Available Color/ Material (Suffix)
PLC1M-S4-C	✓	0	PLC1M-S4-M	✓	0, 30
PLC1.5I-S8-C	✓	0	PLC1.5I-S8-M	✓	0, 30
PLC2S-S6-C	✓	0	PLC2S-S6-M	✓	0
PLC2S-S10-C	✓	0, 14	PLC2S-S10-M	✓	0, 20, 30
PLC3S-S10-C	✓	0	PLC3S-S10-M	✓	0
PLC4S-S10-C	✓	0	PLC4S-S10-M	✓	0, 30
PLC2H-S25-L	✓		PLC2H-S25-TL	✓	0, 30
PLC4H-S25-L	✓	0	PLC4H-S25-TL	✓	0, 30
PLF1M-C	✓	0	PLF1M-M	✓	0, 2, 3, 4, 6, 10, 69
PLF1MA-C	✓	3, 4	PLF1MA-M	✓	0, 2, 3, 4, 5, 6, 10
PLF1MB-C	✓		PLF1MB-M	✓	
PLM1M-C	✓	0	PLM1M-M	✓	0, 1, 2, 3, 4, 5, 6, 7, 8, 10, 69
PLM2M-C	✓		PLM2M-M	✓	0, 4, 6
PLM2S-C	✓	0, 4	PLM2S-D	✓	0, 2, 3, 4, 5, 6, 8
PLM4S-C	✓		PLM4S-D	✓	0, 2, 4, 6



# PANDUIT® Part Number Suffix Codes for All PAN-TY® Cable Ties

Standard Packaging			Bulk Packaging		
Part Number	Natural Nylon 6.6	Available Color/ Material (Suffix)	Part Number	Natural Nylon 6.6	Available Color/ Material (Suffix)
PL2M2S-L	✓	0	PL2M2S-D	✓	0, 4, 10
PL3M2S-L	✓		PL3M2S-D	✓	0, 4
PLP1.5I-C	✓		PLP1.5I-M	✓	0, 30
			PLP1S-M	✓	0, 30
			PLP1.5S-M	✓	
PLP2S-C	✓		PLP2S-M	✓	0, 30
PLT.6SM-C	✓	0	PLT.6SM-M	✓	0, 30
PLT.7M-C	✓		PLT.7M-M	✓	0, 30
PLT1M-C	✓	0, 00, 1, 2, 3, 4, 5, 6, 7, 8, 10, 14, 30, 76, 702	PLT1M-M	✓	0, 00, 1, 2, 3, 4, 5, 6, 7, 8, 10, 14, 20, 30, 53, 54, 55, 59, 60, 69, 76, 100, 109, 300, 702
			PLT1M-XMR	✓	0, 1, 2, 3, 4, 5, 6, 7, 8, 10, 30
PLT1.5M-C	✓	0	PLT1.5M-M	✓	0, 00, 1, 2, 3, 4, 5, 6, 7, 8, 10, 14, 20, 30
			PLT1.5M-XMR	✓	0, 00, 30
PLT2M-C	✓	0	PLT2M-M	✓	0, 1, 2, 3, 4, 5, 6, 7, 8, 10, 20, 30, 69
PLT1.5I-C	✓	0, 1, 2, 3, 4, 5, 6, 7, 8, 10, 20, 30	PLT1.5I-M	✓	0, 00, 1, 2, 3, 4, 5, 6, 7, 8, 10, 20, 30, 69, 100, 109, 120, 300
PLT2I-C	✓	0, 14, 30, 76	PLT2I-M	✓	0, 1, 2, 3, 4, 5, 6, 7, 8, 10, 14, 20, 30, 53, 54, 55, 59, 69, 76, 300
PLT2.5I-C	✓	0	PLT2.5I-M	✓	0, 20
PLT3I-C	✓	0, 14	PLT3I-M	✓	0, 2, 3, 4, 5, 6, 8, 10, 14, 20, 30
PLT4I-C	✓	0, 14	PLT4I-M	✓	0, 2, 5, 6, 14, 20, 30
PLT1S-C	✓	0	PLT1S-M	✓	0, 30, 38, 300
PLT1.5S-C	✓	0	PLT1.5S-M	✓	0, 30
PLT2S-C	✓	0, 00, 1, 2, 3, 4, 5, 6, 7, 8, 10, 20, 30, 76, 702	PLT2S-M	✓	0, 00, 1, 2, 3, 4, 5, 6, 7, 8, 10, 20, 30, 38, 39, 53, 54, 55, 59, 60, 69, 76, 100, 109, 120, 300, 702
PLT2.5S-C	✓	0	PLT2.5S-M	✓	0, 30
PLT3S-C	✓	0, 00, 2, 20, 30, 76, 702	PLT3S-M	✓	0, 00, 1, 2, 3, 4, 5, 6, 7, 8, 10, 20, 30, 53, 54, 55, 59, 76, 100, 109, 702
PLT4S-C	✓	0, 00, 2, 3, 4, 5, 6, 8, 20, 30, 76	PLT4S-M	✓	0, 00, 1, 2, 3, 4, 5, 6, 7, 8, 10, 14, 20, 30, 69, 76, 100, 109, 120, 300
PLT4.5S-C	✓	0	PLT4.5S-M	✓	0
PLT5S-C	✓	0	PLT5S-M	✓	0, 2, 3, 4, 5, 6, 8, 30
PLT6LH-L	✓	0	PLT6LH-C	✓	0
PLT7LH-L	✓	0	PLT7LH-C	✓	0, 30
PLT8LH-L	✓	0	PLT8LH-C	✓	0, 120
PLT8LH-Q		0			
PLT9LH-L	✓	0	PLT9LH-C	✓	0, 30
PLT10LH-L	✓		PLT10LH-C	✓	
PLT2H-L	✓	0	PLT2H-TL	✓	0, 2, 4, 6, 30, 100, 109, 300
PLT2.5H-L	✓	0	PLT2.5H-TL	✓	0
PLT3H-L	✓	0, 76	PLT3H-TL	✓	0, 30, 76, 100, 109
PLT4H-L	✓	0, 00, 76	PLT4H-TL	✓	0, 00, 1, 2, 3, 4, 5, 6, 10, 20, 30, 69, 76, 100, 109, 120, 300
PLT4H-C	✓	0			
PLT5H-L	✓	0	PLT5H-C	✓	0, 30
PLT6H-L	✓	0	PLT6H-C	✓	0, 30
PLT8H-Q		0	PLT8H-C	✓	0, 00, 30
PLT8H-L	✓	0			
PLT13H-Q	✓	0	PLT13H-C	✓	0, 3
PLT2EH-Q		0	PLT2EH-C	✓	0

# PANDUIT® Part Number Suffix Codes for All PAN-TY® Cable Ties

Standard Packaging			Bulk Packaging		
Part Number	Natural Nylon 6.6	Available Color/ Material (Suffix)	Part Number	Natural Nylon 6.6	Available Color/ Material (Suffix)
			<b>PLT3EH-NB-C</b>		0
<b>PLT5EH-Q</b>	✓	0	<b>PLT5EH-C</b>	✓	0
			<b>PLT5EH-NB-C</b>		0
<b>PLT6EH-Q</b>	✓	0	<b>PLT6EH-C</b>	✓	0
			<b>PLT6EH-NB-C</b>		0
<b>PLT8EH-Q</b>		0	<b>PLT8EH-C</b>	✓	0
<b>PLT10EH-Q</b>		0	<b>PLT10EH-C</b>	✓	0
<b>PLT12EH-Q</b>		0	<b>PLT12EH-C</b>	✓	0
			<b>PLUP40S-D</b>		30
			<b>PLUP40SE-D</b>	✓	30
<b>PLWP1M-C</b>	✓		<b>PLWP1M-D</b>	✓	0, 30
<b>PLWP1.5I-C</b>	✓		<b>PLWP1.5I-D</b>	✓	30
<b>PLWP1S-C</b>	✓	0	<b>PLWP1S-D</b>	✓	0, 20, 30
			<b>PLWP1SA-D</b>	✓	
			<b>PLWP1SB-D</b>	✓	
			<b>PLWP1.5S-D</b>	✓	30
			<b>PLWP1.5SA-D</b>	✓	
<b>PLWP2S-C</b>	✓	0	<b>PLWP2S-D</b>	✓	0, 30
			<b>PLWP2SA-D</b>	✓	
			<b>PLWP2SB-D</b>	✓	
			<b>PLWP2H-TL</b>	✓	0, 30
			<b>PLWP3H-TL</b>	✓	0
			<b>PLWP30SC-D</b>		30
			<b>PLWP40SC-D</b>		30
			<b>PLWP40SD-D</b>		30
			<b>PLWP50SC-D</b>		30
			<b>PLWP50SE-D</b>		30
			<b>PRLWP30S-D</b>		30
			<b>PRLWP50S-D</b>		30
<b>PRT1S-C</b>	✓	0	<b>PRT1S-M</b>	✓	0
<b>PRT1.5S-C</b>	✓	0	<b>PRT1.5S-M</b>	✓	0, 30
<b>PRT2S-C</b>	✓	0	<b>PRT2S-M</b>	✓	0, 2, 3, 4, 6, 7
<b>PRT3S-C</b>	✓	0	<b>PRT3S-M</b>	✓	0
<b>PRT4S-C</b>	✓	0	<b>PRT4S-M</b>	✓	0, 2, 3, 4, 6
<b>PRT2H-L</b>	✓	0	<b>PRT2H-TL</b>	✓	0
<b>PRT3H-L</b>	✓	0	<b>PRT3H-TL</b>	✓	0
<b>PRT4H-L</b>	✓	0	<b>PRT4H-TL</b>	✓	0
<b>PRT2EH-Q</b>		0	<b>PRT2EH-C</b>	✓	0, 100
<b>PRT5EH-Q</b>	✓	0	<b>PRT5EH-C</b>	✓	0, 100
<b>PRT6EH-Q</b>	✓	0	<b>PRT6EH-C</b>	✓	0, 100
<b>PRT8EH-Q</b>		0	<b>PRT8EH-C</b>	✓	0, 100
<b>PRT10EH-Q</b>		0	<b>PRT10EH-C</b>	✓	0
<b>PRT12EH-Q</b>		0	<b>PRT12EH-C</b>	✓	0
<b>PRWP1S-C</b>	✓		<b>PRWP1S-D</b>	✓	0
			<b>PRWP1SA-D</b>	✓	
			<b>PRWP1SB-D</b>	✓	
			<b>PRWP1.5S-D</b>	✓	0, 20, 30
			<b>PRWP2S-D</b>	✓	0
			<b>PRWP2H-TL</b>	✓	
			<b>PRST30S-S14-M</b>		30

## DOME-TOP® Barb Ty Cable Tie Features/Benefits

### 1. DOME-TOP® Head

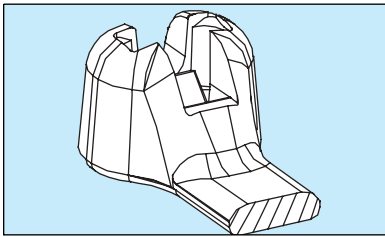

- Unique patented design
- Round smooth edges
- No irritation to installer's hands

### 2. Stainless Steel Barb

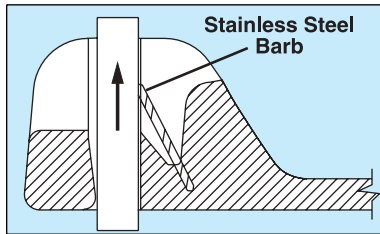

- Made of 316 corrosion resistant stainless steel
- Provides consistent performance and reliability for users who prefer a cable tie with a metal barb
- Infinitely adjustable for tight bundles through its entire bundle range

### 3. Low Threading Force

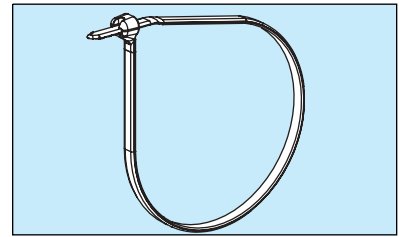

- Reduces installer fatigue
- Increases productivity

### 4. High Tensile Strength

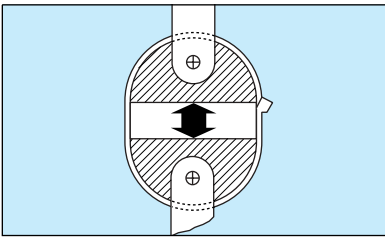

- Exceeds industry and Aerospace Standard SAE (AS23190) standards
- Available in four loop tensile strengths from 18 lbs. (80N) to 120 lbs. (534N) to provide a wide selection

### 5. Anti-Slip Strap Body

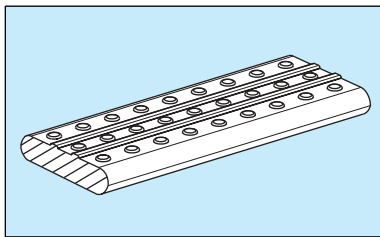

- Ribbed and stippled strap body prevents axial and lateral movement

### 6. Finger Tip Grip

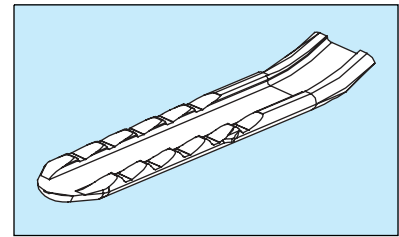

- Exclusively designed finger grip is available on all sizes of DOME-TOP® Barb Ty Cable Ties to assure positive grip during threading of the tie

### 7. Curved Tip

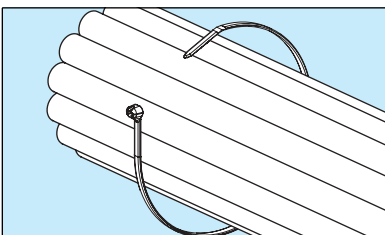

- Orients tip toward head to speed installation; lowers installed cost
- Faster initial threading
- Easier to pick up from flat surfaces

### 8. Material/Size Availability

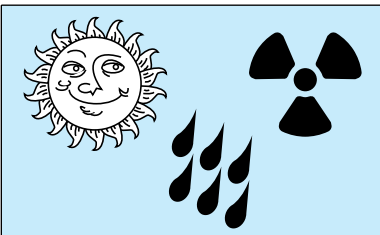

- Available in lengths from 4.0" (102mm) to 30.7" (780mm) to meet a variety of applications
- Several materials available for special environments: Natural 6.6 nylon, weather resistant black 6.6 nylon, heat stabilized 6.6 nylon and 11 different colors

# PANDUIT® DOME-TOP® Barb Ty Cable Ties (BT Series)

## DOME-TOP® Barb Ty Nylon 6.6 Locking Cable Ties

- Available in Miniature, Intermediate, Standard and Light-Heavy cross sections
- Bundle diameters up to 9.00" (229mm)
- Available in natural, weather resistant and heat stabilized nylon and 11 different colors
- Tool or hand installed



Side View Front View

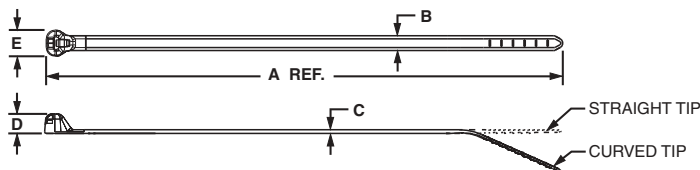

Part Number	Length A in. (mm)	Width B in. (mm)	Thickness C in. (mm)	Head Height D in. (mm)	Head Width E in. (mm)	Max. Bundle Dia. in. (mm)	Min. Loop Tensile Strength Lbs. (N)	Recommended PANDUIT® Installation Tool Part No.	Packaging*			
									Std. Pkg. Qty.*	Std. Ctn. Qty.	Bulk Pkg. Qty.	Bulk Ctn. Qty.

### MINIATURE CROSS SECTION

<b>BT1M-C</b>	4.0 (102)	.095 (2.4)	.036 (0.9)	.156 (4.0)	.172 (4.4)	.90 (23)	18 (80)	GTS, GS2B, PTS, PPTS or STS2	100	1000	1000	50000
<b>BT1.5M-C</b>	6.3 (160)								100	1000	1000	25000
<b>BT2M-C</b>	7.9 (201)		.046 (1.2)		.182 (4.6)	2.00 (51)			100	1000	1000	25000
<b>BT4M-C</b>	14.2 (361)		4.00 (102)		100	1000			1000	10000		

### INTERMEDIATE CROSS SECTION

<b>BT1.5I-C</b>	6.1 (155)	.141 (3.6)	.041 (1.0)	.185 (4.7)	.248 (6.3)	1.50 (38)	40 (178)	GTS, GS2B, PTS, PPTS or STS2	100	1000	1000	25000
<b>BT2I-C</b>	8.0 (203)								2.00 (51)	100	1000	1000
<b>BT3I-C</b>	11.3 (287)		.049 (1.2)		3.00 (76)	100			1000	1000	10000	
<b>BT4I-C</b>	14.3 (363)		4.00 (102)		100	1000			1000	10000		

### STANDARD CROSS SECTION

<b>BT2S-C</b>	8.0 (203)	.185 (4.7)	.045 (1.2)	.220 (5.6)	.320 (8.1)	2.00 (51)	50 (222)	GTS, GS2B, GTH, GS4H, PTS, PPTS, STS2 or STH2	100	1000	1000	10000
<b>BT3S-C</b>	12.0 (305)								3.00 (76)	100	1000	1000
<b>BT4S-C</b>	15.1 (384)		.052 (1.3)		4.00 (102)	100			1000	1000	10000	

### LIGHT-HEAVY CROSS SECTION (STRAIGHT TIP)

<b>BT2LH-L</b>	8.7 (221)	.275 (7.0)	.065 (1.7)	.320 (8.1)	.520 (13.2)	2.00 (51)	120 (534)	GTH, GS4H, GS4EH, PPTEH, STH2 or ST2EH	50	500	250	2500
<b>BT3LH-L</b>	11.8 (300)					3.00 (76)			50	500	250	2500
<b>BT4LH-L</b>	14.9 (378)					4.00 (102)			50	500	250	2500
<b>BT5LH-L</b>	18.1 (460)					5.00 (127)			50	500	100	2000
<b>BT6LH-L</b>	21.2 (538)					6.00 (152)			50	500	100	2000
<b>BT7LH-L</b>	24.4 (620)					7.00 (178)			50	500	100	2000
<b>BT8LH-L</b>	27.5 (699)					8.00 (203)			50	500	100	1000
<b>BT9LH-L</b>	30.7 (780)					9.00 (229)			50	500	100	1000

# PANDUIT® Weather Resistant *DOME-TOP*® Barb Ty Cable Ties (BT Series)

## *DOME-TOP*® Barb Ty Weather Resistant Nylon 6.6 Locking Cable Ties

- Available in Miniature, Intermediate, Standard and Light-Heavy cross sections
- Bundle diameters up to 9.00" (229mm)
- Weather resistant nylon has greater resistance to ultraviolet light which damages natural nylon
- Tool or hand installed



Side View

Front View

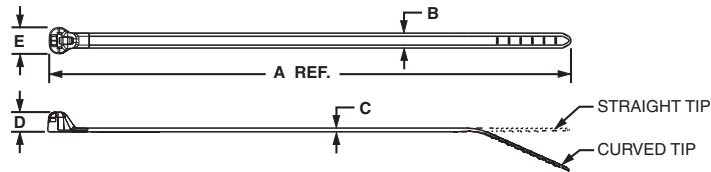

Part Number	Length A in. (mm)	Width B in. (mm)	Thickness C in. (mm)	Head Height D in. (mm)	Head Width E in. (mm)	Max. Bundle Dia. in. (mm)	Min. Loop Tensile Strength Lbs. (N)	Recommended PANDUIT® Installation Tool Part No.	Packaging*			
									Std. Pkg. Qty.	Std. Ctn. Qty.	Bulk Pkg. Qty.	Bulk Ctn. Qty.

### MINIATURE CROSS SECTION

<b>BT1M-C0</b>	4.0 (102)	.095 (2.4)	.036 (0.9)	.156 (4.0)	.172 (4.4)	.90 (23)	18 (80)	GTS, GS2B, PTS, PPTS or STS2	100	1000	1000	50000
<b>BT1.5M-C0</b>	6.3 (160)								100	1000	1000	25000
<b>BT2M-C0</b>	7.9 (201)								100	1000	1000	25000
<b>BT4M-C0</b>	14.2 (361)								100	1000	1000	10000

### INTERMEDIATE CROSS SECTION

<b>BT1.5I-C0</b>	6.1 (155)	.141 (3.6)	.041 (1.0)	.185 (4.7)	.248 (6.3)	1.50 (38)	40 (178)	GTS, GS2B, PTS, PPTS or STS2	100	1000	1000	25000
<b>BT2I-C0</b>	8.0 (203)								100	1000	1000	25000
<b>BT3I-C0</b>	11.3 (287)								100	1000	1000	10000
<b>BT4I-C0</b>	14.3 (363)								100	1000	1000	10000

### STANDARD CROSS SECTION

<b>BT2S-C0</b>	8.0 (203)	.185 (4.7)	.045 (1.2)	.220 (5.6)	.320 (8.1)	2.00 (51)	50 (222)	GTS, GS2B, GTH, GS4H, PTS, PPTS, STS2 or STH2	100	1000	1000	10000
<b>BT3S-C0</b>	12.0 (305)								100	1000	1000	10000
<b>BT4S-C0</b>	15.1 (384)								100	1000	1000	5000

### LIGHT-HEAVY CROSS SECTION (STRAIGHT TIP)

<b>BT2LH-L0</b>	8.7 (221)	.275 (7.0)	.065 (1.7)	.320 (8.1)	.520 (13.2)	2.00 (51)	120 (534)	GTH, GS4H, GS4EH, PPTEH, STH2, or ST2EH	50	500	250	2500
<b>BT3LH-L0</b>	11.8 (300)								50	500	250	2500
<b>BT4LH-L0</b>	14.9 (378)								50	500	250	2500
<b>BT5LH-L0</b>	18.1 (460)								50	500	100	2000
<b>BT6LH-L0</b>	21.2 (538)								50	500	100	2000
<b>BT7LH-L0</b>	24.4 (620)								50	500	100	2000
<b>BT8LH-L0</b>	27.5 (699)								50	500	100	1000
<b>BT9LH-L0</b>	30.7 (780)								50	500	100	1000

\*Order the number of pieces required in multiples of package quantities.  
 For colors and other materials, see pages 34-35.  
 All part numbers shown in standard package quantities unless denoted by ‡

# PANDUIT® DOME-TOP® Barb Ty Heat Stabilized Cable Ties (BT Series)

## DOME-TOP® Barb Ty Heat Stabilized Nylon 6.6 — Natural Color

- Available in Miniature, Intermediate, Standard and Light-Heavy cross sections
- Bundle diameters up to 4.00" (102mm)
- Temperature rating: -40°F (-40°C) to 239°F (115°C)



Side View



Front View

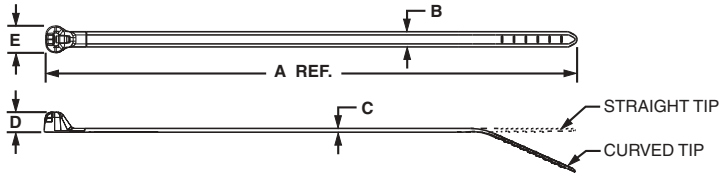

Part Number	Length A in. (mm)	Width B in. (mm)	Thickness C in. (mm)	Head Height D in. (mm)	Head Width E in. (mm)	Max. Bundle Dia. in. (mm)	Min. Loop Tensile Strength Lbs. (N)	Recommended PANDUIT® Installation Tool Part No.	Packaging*				
									Std. Pkg. Qty.	Std. Ctn. Qty.	Bulk Pkg. Qty.	Bulk Ctn. Qty.	
<b>MINIATURE CROSS SECTION</b>													
<b>BT1M-M39‡</b>	4.0 (102)	.095 (2.4)	.036 (0.9)	.156 (4.0)	.172 (4.4)	.90 (23)	18 (80)	GTS, GS2B, PTS, PPTS or STS2	—	—	1000	50000	
<b>INTERMEDIATE CROSS SECTION</b>													
<b>BT1.5I-M39‡</b>	6.1 (155)	.141 (3.6)	.041 (1.0)	.185 (4.7)	.248 (6.3)	1.50 (38)	40 (178)	GTS, GS2B, PTS, PPTS or STS2	—	—	1000	25000	
<b>STANDARD CROSS SECTION</b>													
<b>BT2S-M39‡</b>	8.0 (203)	.185 (4.7)	.045 (1.2)	.220 (5.6)	.320 (8.1)	2.00 (51)	50 (222)	GTS, GS2B GTH, GS4H, PTS, PPTS, STS2 or STH2	—	—	1000	10000	
<b>BT3S-M39‡</b>	12.0 (305)		.052 (1.3)						—	—	1000	10000	
<b>BT4S-M39‡</b>	15.1 (384)		—						—	1000	5000		
<b>LIGHT-HEAVY CROSS SECTION (STRAIGHT TIP)</b>													
<b>BT4LH-TL39‡</b>	14.9 (378)	.275 (7.0)	.065 (1.7)	.320 (8.1)	.520 (13.2)	4.00 (102)	120 (534)	GTH, GS4H, GS4EH, PPTEH, STH2 or ST2EH	—	—	250	2500	

## DOME-TOP® Barb Ty Nylon 6.6 Winged Push Mount Ties

Push mount ties are used to attach a cable bundle to a surface such as a flat panel. The anchor is easily pressed into a pre-drilled hole and locks in place. The wings provide constant tension when installed, creating a stable, secure fixture and rattle-free installation.

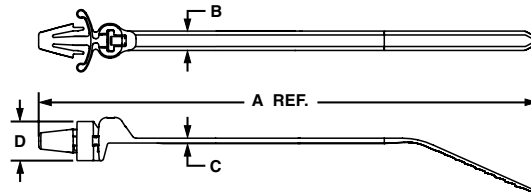

Part Number	Length A in. (mm)	Width B in. (mm)	Thickness C in. (mm)	Head Height D in. (mm)	Nominal Hole Dia. in. (mm)	Max. Panel Thickness in. (mm)	Max. Bundle Dia. in. (mm)	Min. Loop Tensile Strength Lbs. (N)	Recommended PANDUIT® Installation Tool Part No.	Packaging*			
										Std. Pkg. Qty.	Std. Ctn. Qty.	Bulk Pkg. Qty.	Bulk Ctn. Qty.
<b>INTERMEDIATE CROSS SECTION</b>													
<b>BW1.5I-D</b>	6.6 (168)	.141 (3.6)	.041 (1.0)	.280 (7.1)	.187 (4.7)	.093 (2.4)	1.50 (38)	40 (178)	GTS, GS2B, PTS, PPTS or STS2	—	—	500	5000
<b>STANDARD CROSS SECTION</b>													
<b>BW2S-D</b>	8.5 (216)	.185 (4.7)	.052 (1.3)	.370 (9.4)	.250 (6.4)	.156 (4.0)	2.00 (51)	50 (222)	GTS, GS2B GTH, GS4H, PTS, PPTS, STS2 or STH2	—	—	500	5000

# PANDUIT® DOME-TOP® Barb Ty Clamp Ties

## DOME-TOP® Barb Ty Nylon 6.6 Clamp Ties



Side View



Front View

- Used to secure a bundle to another surface
- The design allows for bundling before or after screwing clamp in place
- Available in Miniature, Intermediate, Standard and Light-Heavy cross sections
- Bundle diameters up to 4.00" (102mm)
- Available in natural, weather resistant and heat stabilized black nylon

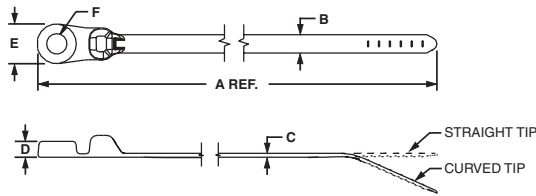

Part Number	Length A in. (mm)	Width B in. (mm)	Thickness C in. (mm)	Boss Height D in. (mm)	Boss Width E in. (mm)	Nominal Hole Dia. F in. (mm)	Screw Size (Metric)	Max. Bundle Dia. in. (mm)	Min. Loop Tensile Strength Lbs. (N)	Recommended PANDUIT® Installation Tool Part No.	Packaging*			
											Std. Pkg. Qty.	Std. Ctn. Qty.	Bulk Pkg. Qty.	Bulk Ctn. Qty.
<b>MINIATURE CROSS SECTION</b>														
BC1MS4-M‡	4.6 (117)	.095 (2.4)	.046 (1.2)	.156 (4.0)	.234 (5.9)	.124 (3.15)	#4 (M2.5)	.90 (23)	18 (80)	GTS, GS2B, PTS, PPTS or STS2	100	1000	1000	50000
BC2M-S4-M‡	8.3 (211)	.095 (2.4)	.046 (1.2)	.156 (4.0)	.234 (5.9)	.124 (3.15)	#4 (M2.5)	2.0 (51)			100	1000	1000	25000
<b>INTERMEDIATE CROSS SECTION</b>														
BC1.5I-S8-M‡	6.6 (168)	.141 (3.6)	.041 (1.0)	.166 (4.2)	.330 (8.4)	.180 (4.57)	#8 (M4)	1.5 (38)	40 (178)	GTS, GS2B, PTS, PPTS or STS2	100	1000	1000	25000
<b>STANDARD CROSS SECTION</b>														
BC2S-S10-C	8.5 (216)	.185 (4.7)	.052 (1.3)	.160 (4.1)	.400 (10.2)	.206 (5.2)	#10 (M5)	2.00 (51)	50 (222)	GTS, GS2B, GTH, GS4H, PTS, PPTS, STS2 or STH2	100	1000	500	10000
BC3S-S10-D	12.5 (318)							3.00 (76)			—	—	500	10000
BC4S-S10-C	15.6 (396)							4.00 (102)			100	1000	500	5000
<b>LIGHT-HEAVY CROSS SECTION (STRAIGHT TIP)</b>														
BC4LH-S25-L	15.5 (394)	.275 (7.0)	.065 (1.7)	.265 (6.7)	.520 (13.2)	.260 (6.6)	1/4 (M6)	4.00 (102)	120 (534)	GTH, GS4H, GS4EH, PPTEH, STH2 or ST2EH	50	500	250	2500

## DOME-TOP® Barb Ty Weather Resistant Nylon Clamp Ties



Part Number	Length A in. (mm)	Width B in. (mm)	Thickness C in. (mm)	Boss Height D in. (mm)	Boss Width E in. (mm)	Nominal Hole Dia. F in. (mm)	Screw Size (Metric)	Max. Bundle Dia. in. (mm)	Min. Loop Tensile Strength Lbs. (N)	Recommended PANDUIT® Installation Tool Part No.	Packaging*			
											Std. Pkg. Qty.	Std. Ctn. Qty.	Bulk Pkg. Qty.	Bulk Ctn. Qty.
<b>STANDARD CROSS SECTION</b>														
BC2S-S10-C0	8.5 (216)	.185 (4.7)	.052 (1.3)	.160 (4.1)	.400 (10.2)	.206 (5.2)	#10 (M5)	2.00 (51)	50 (222)	GTS, GS2B, GTH, GS4H, PTS, PPTS, STS2 or STH2	100	500	1000	10000
BC3S-S10-D0	12.5 (318)							3.00 (76)			—	—	1000	10000
BC4S-S10-C0	15.6 (396)							4.00 (102)			100	500	1000	5000
<b>LIGHT-HEAVY CROSS SECTION</b>														
BC4LH-S25-L0	15.5 (394)	.275 (7.0)	.065 (1.7)	.265 (6.7)	.520 (13.2)	.260 (6.6)	1/4 (M6)	4.00 (102)	120 (534)	GTH, GS4H, GS4EH, PPTEH, STH2 or ST2EH	50	500	250	2500

\*Order the number of pieces required in multiples of package quantities.  
For colors and other materials, see pages 34-35.  
All part numbers shown in standard package quantities unless denoted by ‡.

# PANDUIT® DOME-TOP® Barb Ty Marker and Flag Ties (BM/BF Series)

## DOME-TOP® Barb Ty Nylon 6.6 Marker and Flag Ties

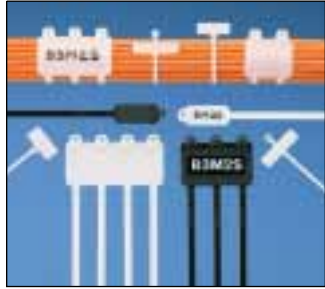

- Used to fasten and identify bundles at the same time
- They can be marked with *PANDUIT*® Marker Pens, Custom Hot Stamping Service on [page 52](#) or Computer Printable Labels
- Available in Miniature and Standard Cross Section
- Bundle diameters up to 4.00" (102mm)
- Available in natural and weather resistant nylon

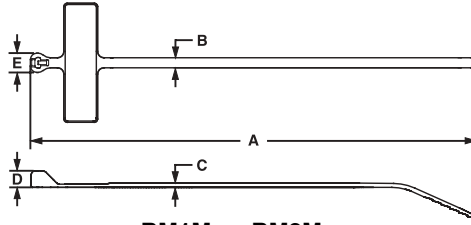

BM1M BM2M



Part Number	Length A in. (mm)	Width B in. (mm)	Thickness C in. (mm)	Head Height D in. (mm)	Head Width E in. (mm)	Marker Write-on Area in. (mm)	Max. Bundle Dia. in. (mm)	Min. Loop Tensile Strength Lbs. (N)	Recommended <i>PANDUIT</i> ® Installation Tool Part No.	Packaging*			
										Std. Pkg. Qty.	Std. Ctn. Qty.	Bulk Pkg. Qty.	Bulk Ctn. Qty.
<b>MINIATURE CROSS SECTION</b>													
<b>BM1M-C</b>	4.2 (107)	.095 (2.4)	.046 (1.2)	.156 (4.0)	.182 (4.6)	.29 x 1.09 (7.4) x (27.7)	.90 (23)	18 (80)	GTS, GS2B PTS, PPTS or STS2	100	1000	1000	25000
<b>BM2M-C</b>	7.9 (201)						2.00 (51)			100	1000	1000	25000

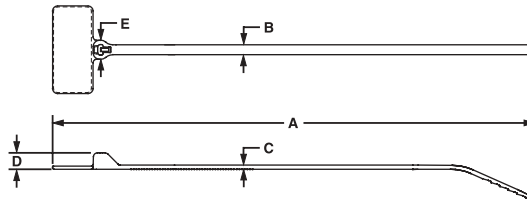

BF1M BF2M

Part Number	Length A in. (mm)	Width B in. (mm)	Thickness C in. (mm)	Head Height D in. (mm)	Head Width E in. (mm)	Marker Write-on Area in. (mm)	Max. Bundle Dia. in. (mm)	Min. Loop Tensile Strength Lbs. (N)	Recommended <i>PANDUIT</i> ® Installation Tool Part No.	Packaging*			
										Std. Pkg. Qty.*	Std. Ctn. Qty.	Bulk Pkg. Qty.	Bulk Ctn. Qty.
<b>MINIATURE CROSS SECTION</b>													
<b>BF1M-C</b>	4.6 (117)	.095 (2.4)	.046 (1.2)	.156 (4.0)	.182 (4.6)	.36 x .81 (9.1) x (20.6)	.90 (23)	18 (80)	GTS, GS2B, PTS, PPTS or STS2	100	1000	1000	25000
<b>BF2M-C</b>	8.3 (211)						2.00 (51)			100	1000	1000	25000

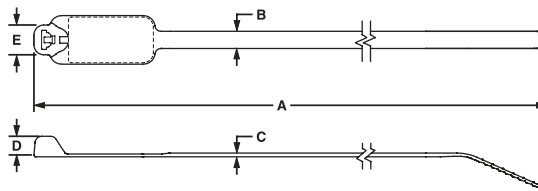

BM2S BM4S

Part Number	Length A in. (mm)	Width B in. (mm)	Thickness C in. (mm)	Head Height D in. (mm)	Head Width E in. (mm)	Marker Write-on Area in. (mm)	Max. Bundle Dia. in. (mm)	Min. Loop Tensile Strength Lbs. (N)	Recommended <i>PANDUIT</i> ® Installation Tool Part No.	Packaging*			
										Std. Pkg. Qty.	Std. Ctn. Qty.	Bulk Pkg. Qty.	Bulk Ctn. Qty.
<b>STANDARD CROSS SECTION</b>													
<b>BM2S-C</b>	8.0 (203)	.185 (4.7)	.045 (1.2)	.220 (5.6)	.320 (8.1)	.49 x .91 (12.4) x (23.1)	2.00 (51)	50 (222)	GTS, GS2B GTH, GS4H, PTS, PPTS or STH2	100	1000	500	10000
<b>BM4S-C</b>	15.1 (384)		.052 (1.3)			.50 x 2.13 (12.7) x (54.1)	4.00 (102)			100	1000	500	10000



**DOME-TOP® Barb Ty Nylon 6.6 Marker Ties (con't)**

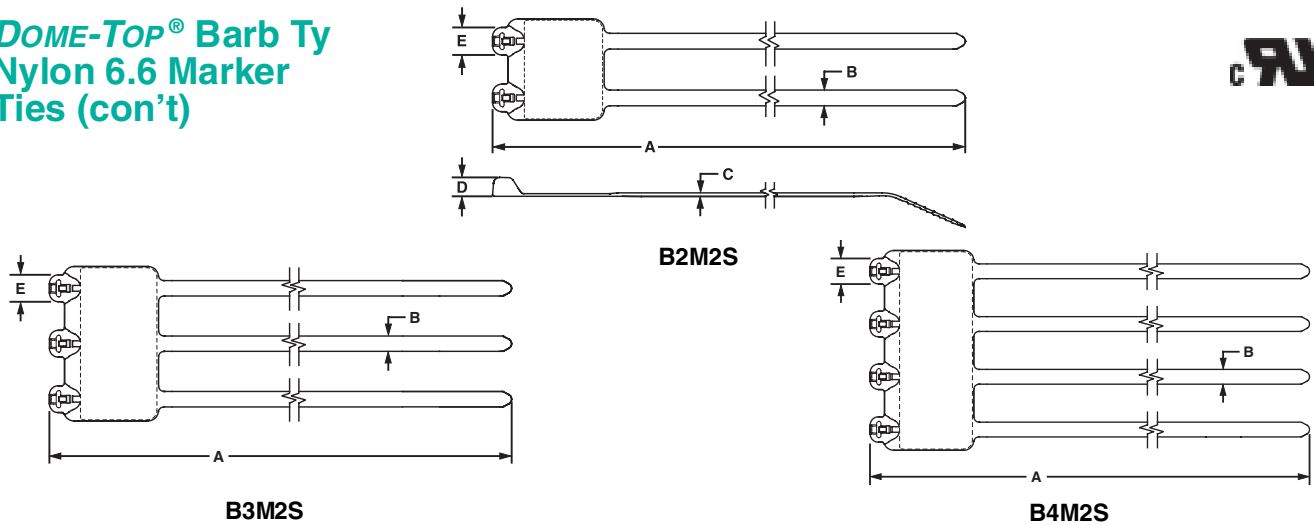

Part Number	Length A in. (mm)	Width B in. (mm)	Thickness C in. (mm)	Head Height D in. (mm)	Head Width E in. (mm)	Marker Write-On Area in. (mm)	Max. Bundle Dia. in. (mm)	Min. Loop Tensile Strength Lbs. (N)	Recommended PANDUIT® Installation Tool Part No.	Packaging*				
										Std. Pkg. Qty.*	Std. Ctn. Qty.	Bulk Pkg. Qty.	Bulk Ctn. Qty.	
<b>STANDARD CROSS SECTION</b>														
<b>B2M2S-D‡</b>						11.5 x .91 (29.2) x (23.1)				GTS, GS2B, GTH, GS4H, PTS, PPTS, STS2 or STH2	50	500	500	2500
<b>B3M2S-TL‡</b>	8.0 (203)	.185 (4.7)	.045 (1.2)	.220 (5.6)	.320 (8.1)	1.81 x .91 (46.0) x (23.1)	2.00 (51)	50 (222)			50	500	250	2500
<b>B4M2S-TL‡</b>						2.47 x .91 (62.7) x (23.1)					50	500	250	2500

**DURA-TY™ Weather Resistant Cable Ties**



- Ideal for all outdoor messenger strand applications including telephone, cable TV, traffic signals and outside plant power services
- Weather Resistant Acetal strap body and head
- Double stainless steel Type 302 locking barbs
- High tensile strength and high impact resistance
- Excellent chemical and moisture resistance
- 250 lbs. Minimum loop tensile strength
- Meets Telcordia TR-TSY-000789
- May be used with Stackable Cable Spacers SACS50-T100 (see page 107)

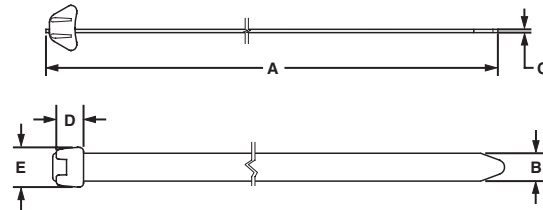

Part Number	Description	Length (A) in. (mm)	Strap Width (B) in. (mm)	Thickness (C) in. (mm)	Head Height in. (mm)	Head Width in. (mm)	Max Bundle Dia. in. (mm)	Min. Loop Tensile Strength N (Lbs.)	Recommended PANDUIT® Installation Tool Part No.	Packaging*			
										Std. Pkg. Qty.	Std. Ctn. Qty.	Bulk Pkg. Qty.	Bulk Ctn. Qty.
<b>DT4EH-L0</b>	Cable Tie	13.5 (343)	.500 (12.7)	.059 (1.5)	.490 (12.4)	.718 (18.2)	3.87 (98)	250 (1112)	GTH, GS4H, ST2EH or GS4EH	50	1000	—	—
<b>DT8EH-Q0</b>		27.0 (686)								25	500	—	—
<b>DTREH-LR0</b>	50' Reel of Strapping	600.0 (15,240)	—	—	—	As Needed	—	1		20	—	—	
<b>DTHEH-Q0</b>	Bag of 25 Cable Tie Heads	—	—	—	.490 (12.4)	.718 (18.2)	—	—		25	500	—	—
<b>DTKEH-0</b>	DURA-TY™ Kit 50 ft. Reel of Strapping	600.0 (15,240)	.500 (12.7)	.059 (1.5)	.490 (12.4)	.718 (18.2)	As Needed	250 (1112)		1	20	—	—

\*Order the number of pieces required in multiples of package quantities.  
For colors and other materials, see pages 34-35.  
All part numbers shown in standard package quantities unless denoted by ‡

# PANDUIT® Part Number Suffix Codes for all DOME-TOP® Barb Ty and DURA-TY™ Cable Ties

## Part Number System (Example of BT1M-C)

BT

1

M

— C

### Part Description:

BT = Barb Ty  
BC = Barb Clamp  
BF = Barb Flag  
BM = Barb Marker  
BW = Barb Wing  
DT = DURA-TY™

### Size:

Approximate  
Maximum Bundle  
Diameter in Inches

### Cross Section:

M = Miniature  
I = Intermediate  
S = Standard  
LH = Light-Heavy  
EH = Extra-Heavy

### Screw Hole Size: (Clamp Ties Only)

-S4 = #4 (M2.5)  
-S6 = #6 (M3)  
-S8 = #8 (M4)  
-S10 = #10 (M5)  
-S25 = 1/4 (M6)

### Package Size:

Q = 25  
L = 50  
C = 100  
TL = 250  
D = 500  
M = 1000  
LR = 50' Reel  
0 = DT Kit

### Color:

See Material/Color  
chart. Not all ties  
available in all colors.

## Material/Color Chart

Material/Color	PANDUIT® Suffix*	Mil Spec Suffix**	Material/Color	PANDUIT® Suffix*	Mil Spec Suffix**
Nylon 6.6 — Natural (See Note)	✓	9	Nylon 6.6 — Blue	6	6
Weather Resistant Nylon 6.6 — Black	0	N/A	Nylon 6.6 — Purple	7	7
Nylon 6.6 — Brown	1	1	Nylon 6.6 — Gray	8	8
Nylon 6.6 — Red	2	2	Nylon 6.6 — White	10	N/A
Nylon 6.6 — Orange	3	3	Nylon 6.6 — Telephone Gray	14	N/A
Nylon 6.6 — Yellow	4	4	Nylon 6.6 — Black	20	N/A
Nylon 6.6 — Green	5	5	Heat Stabilized Nylon 6.6 — Black	30	N/A
			Heat Stabilized Nylon 6.6 — Natural	39	N/A

\* NOTE: ✓ designates PANDUIT® standard Natural Nylon 6.6 color/material. No suffix required in part number.

\*\* NOTE: MIL SPEC Color (suffix) per AS33671 (Formerly MS3367) and SAE AS33681 (Formerly MS3368).

Standard Packaging			Bulk Packaging		
Part Number	Natural Nylon 6.6	Available Color/Material (Suffix)	Part Number	Natural Nylon 6.6	Available Color/Material (Suffix)
			BC1M-S4-M	✓	0
			BC2M-S4-M	✓	0
			BC1.5I-S8-M	✓	0
BC2S-S10-C	✓	0	BC2S-S10-D	✓	0
			BC3S-S10-D	✓	0
BC4S-S10-C	✓	0	BC4S-S10-D	✓	0, 30
BC4LH-S25-L	✓	0	BC4LH-S25-TL	✓	0
BF1M-C	✓		BF1M-M	✓	0
BF2M-C	✓		BF2M-M	✓	0
BM1M-C	✓		BM1M-M	✓	0
BM2M-C	✓		BM2M-M	✓	0
BM2S-C	✓		BM2S-D	✓	0
BM4S-C	✓		BM4S-D	✓	0
BT1M-C	✓	0, 30	BT1M-M	✓	0, 1, 2, 3, 4, 5, 6, 7, 8, 10, 30, 39
BT1.5M-C	✓	0	BT1.5M-M	✓	0, 30
BT2M-C	✓	0	BT2M-M	✓	0, 2, 3, 4, 5, 6, 8, 30
BT4M-C	✓	0	BT4M-M	✓	0
BT1.5I-C	✓	0	BT1.5I-M	✓	0, 1, 2, 3, 4, 5, 6, 7, 8, 10, 30, 39
BT2I-C	✓	0	BT2I-M	✓	0, 30
BT3I-C	✓	0	BT3I-M	✓	0, 30
BT4I-C	✓	0	BT4I-M	✓	0, 14

**PANDUIT®** Part Number Suffix Codes for all *DOME-TOP®* Barb Ty and *DURA-TY™* Cable Ties

Standard Packaging			Bulk Packaging		
Part Number	Natural Nylon 6.6	Available Color/ Material (Suffix)	Part Number	Natural Nylon 6.6	Available Color/ Material (Suffix)
BT2S-C	✓	0	BT2S-M	✓	0, 1, 2, 3, 4, 5, 6, 7, 8, 10, 20, 30, 39
BT3S-C	✓	0, 2	BT3S-M	✓	0, 30, 39
BT4S-C	✓	0	BT4S-M	✓	0, 2, 3, 4, 5, 6, 7, 8, 10, 30, 39
BT2LH-L	✓	0	BT2LH-TL	✓	0
BT3LH-L	✓	0	BT3LH-TL	✓	0
BT4LH-L	✓	0	BT4LH-TL	✓	0, 30, 39
BT5LH-L	✓	0	BT5LH-C	✓	0
BT6LH-L	✓	0	BT6LH-C	✓	0
BT7LH-L	✓	0	BT7LH-C	✓	0
BT8LH-L	✓	0	BT8LH-C	✓	0
BT9LH-L	✓	0	BT9LH-C	✓	0
			BW1.5I-D	✓	
			BW2S-D	✓	0
			B2M2S-D	✓	0
			B3M2S-TL	✓	0
			B4M2S-TL	✓	0
<sup>1</sup> DTHEH-Q		0			
<sup>1</sup> DTKEH		0			
<sup>1</sup> DTREH-LR		0			
<sup>1</sup> DT4EH-L		0			
<sup>1</sup> DT8EH-Q		0			

NOTE 1: *DURA-TY™* Weather Resistant Acetal Strap Body and Head.

## CONTOUR-TY® Cable Ties Nylon 6.6 and Weather Resistant Nylon 6.6



- Head designed for no protrusion of cut-off tie
- Tie configuration limits exposure to sharp edges to protect adjacent cables and installers arms and hands
- Low profile head reduces overall bundle size
- Locking wedge is fully enclosed to insure consistent strength and lasting performance
- Fully rounded edges on head and strap protect cable insulation/jacket
- Rounded tip and aggressive grip for faster initial threading

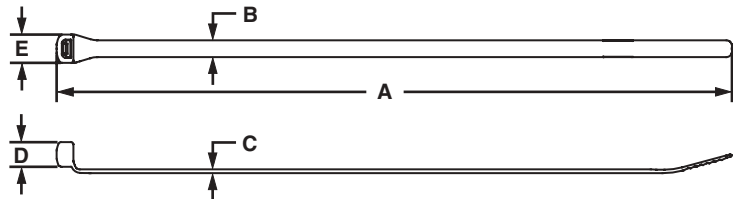

Part Number	Length A in. (mm)	Width B in. (mm)	Thickness C in. (mm)	Head Height D in. (mm)	Head Width E in. (mm)	Max. Bundle Dia. in. (mm)	Min. Loop Tensile Strength Lbs. (N)	Recommended PANDUIT® Installation Tool Part No.	Packaging*			
									Std. Pkg. Qty.	Std. Ctn. Qty.	Bulk Pkg. Qty.	Bulk Ctn. Qty.

### MINIATURE CROSS SECTION

CBR1M-M‡	4.1 (104)	.098 (2.5)	.038 (1.0)	.208 (5.3)	.195 (5.0)	1.00 (25)	18 (80)	GTS, GS2B, PTS or PPTS	—	—	1000	50000
CBR1M-M0‡					.209 (5.3)	1.50 (38)			—	—	1000	50000
CBR1.5M-M‡	5.6 (142)	.042 (1.1)							—	—	1000	50000
CBR1.5M-M0‡												

### INTERMEDIATE CROSS SECTION

CBR1.5I-M‡	5.9 (150)	.140 (3.6)	.040 (1.0)	.250 (6.4)	.250 (6.4)	1.50 (38)	40 (178)	GTS, GS2B, PTS or PPTS	—	—	1000	25000
CBR1.5I-M0‡					.262 (6.7)	3.00 (76)			—	—	1000	10000
CBR3I-M‡	10.4 (264)	.052 (1.3)							—	—	1000	10000
CBR3I-M0‡												

### STANDARD CROSS SECTION

CBR2S-M‡	7.6 (193)	.190 (4.8)	.044 (1.1)	.290 (7.1)	.332 (8.4)	2.00 (51)	50 (222)	GTS, GS2B, PTS or PPTS	—	—	1000	10000
CBR2S-M0‡					.400 (102)	3.00 (76)			—	—	1000	5000
CBR3S-M‡	10.8 (274)	.052 (1.3)							—	—	1000	5000
CBR3S-M0‡												

### HEAVY-STANDARD CROSS SECTION

CBR2HS-D‡	8.0 (203)	.250 (6.4)	.058 (1.4)	.326 (8.2)	.388 (9.9)	2.00 (51)	85 (378)	GTH or GS4H	—	—	500	5000
CBR2HS-D0‡												

### LIGHT-HEAVY CROSS SECTION

CBR4LH-TL‡	14.6 (371)	.300 (7.6)	.070 (1.8)	.400 (10.2)	.490 (12.4)	4.00 (102)	120 (534)	GTH, GS4H or PPTEH	—	—	250	2500
CBR4LH-TL0‡						6.00 (152)			—	—	100	2000
CBR6LH-C‡	20.9 (531)											
CBR6LH-C0‡												

**BELT-TY™** In-Line Cable Ties Nylon 6.6

- Head designed for no protrusion of cut-off tie
- Low profile head (35% lower than conventional 90° entry cable ties)
- Fully rounded edges on head and strap
- Rounded tip and aggressive grip
- Finger grip shaped head
- Curved tip
- Protects adjacent cables and protects workers arms and hands
- Avoids snags and reduces overall bundle size
- No sharp edges in contact with cable insulation
- Easy to grip for assembly
- Positive grip when threading tie
- Material: Nylon 6.6

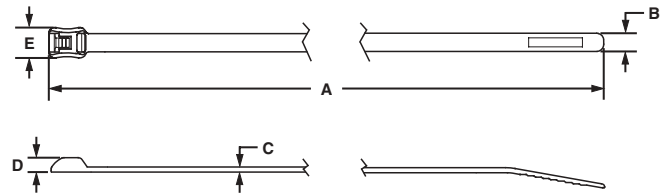

- Parallel-entry cable ties that thread like a belt (at 180°) with the same performance of conventional (90° entry) cable ties
- The *BELT-TY™* In-Line Cable Tie design reduces the long cut-off danger of an incorrectly applied conventional cable tie



Part Number	Length A in. (mm)	Width B in. (mm)	Thickness C in. (mm)	Head Height D in. (mm)	Head Width E in. (mm)	Max. Bundle Dia. in. (mm)	Min. Loop Tensile Strength Lbs. (N)	Recommended <i>PANDUIT®</i> Installation Tool Part No.	Packaging*			
									Std. Pkg. Qty.	Std. Ctn. Qty.	Bulk Pkg. Qty.	Bulk Ctn. Qty.
<b>MINIATURE CROSS SECTION</b>												
<b>ILT1M-M‡</b>	4.8 (122)	.098 (2.5)	.044 (1.1)	.110 (2.8)	.190 (4.8)	1.10 (28)	18 (80)	GTS, GS2B, PTS or PPTS	—	—	1000	50,000
<b>INTERMEDIATE CROSS SECTION</b>												
<b>ILT1.5I-M‡</b>	5.4 (137)	.142 (3.6)	.052 (1.3)	.130 (3.3)	.260 (6.6)	1.38 (35)	30 (133)	GTS, GS2B, PTS or PPTS	—	—	1000	25,000
<b>STANDARD CROSS SECTION</b>												
<b>ILT2S-M‡</b>	8.3 (211)	.190 (4.8)	.052 (1.3)	.140 (3.6)	.316 (8.0)	1.88 (48)	50 (222)	GTS, GS2B, GTH, GS4H, PTS or PPTS	—	—	1000	10,000
<b>ILT3S-M‡</b>	11.5 (292)					3.00 (76)			—	—	1000	5000
<b>ILT4S-M‡</b>	14.7 (373)					4.00 (102)			—	—	1000	5000
<b>LIGHT-HEAVY CROSS SECTION</b>												
<b>ILT4LH-TL‡</b>	14.8 (376)	.300 (7.6)	.075 (1.9)	.250 (6.4)	.475 (12.1)	4.00 (102)	120 (534)	GTH, GS4H or PPTEH	—	—	250	2500
<b>ILT6LH-C‡</b>	21.2 (538)					6.00 (152)			—	—	100	500

\*Order the number of pieces required in multiples of package quantities.  
 For colors and other materials, see page 39.  
 All part numbers shown in standard package quantities unless denoted by ‡.

# PANDUIT® IN-LINE Nylon 6.6 Cable Ties

## IN-LINE Weather Resistant Nylon 6.6 Cable Ties



Colors can be used to install foam padding for playground applications.



UV Black can be used in any outdoor application.

- Wide tie body and high tensile strength are ideal for any application including playground equipment
- For playground installations, the head is inverted and the body is captured between the tie and foam for safety
- Flexible, easy to handle and easily installed without special tools
- Available in 13 UV weather resistant colors for color coordination and UV stability

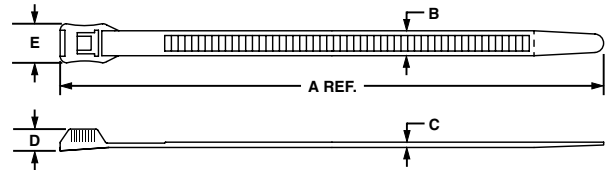

Part Number	Description	Length A in. (mm)	Width B in. (mm)	Thickness C in. (mm)	Head Height D in. (mm)	Head Width E in. (mm)	Max. Bundle Dia. in. (mm)	Min. Loop Tensile Strength Lbs. (N)	Packaging*			
									Std. Pkg. Qty.	Std. Ctn. Qty.	Bulk Pkg. Qty.*	Bulk Ctn. Qty.*

### Cable Tie Colors

IT9100-CUV2‡	UV Red	14.1 (358)	.350 (8.9)	.065 (1.7)	.300 (7.6)	.556 (14.1)	3.94 (100)	124 (550)	—	—	100	1000
IT9100-CUV4‡	UV Yellow								—	—	100	1000
IT9100-CUV4A‡	UV Butterscotch								—	—	100	1000
IT9100-CUV5A‡	UV Green								—	—	100	1000
IT9100-CUV5B‡	UV Hunter Green								—	—	100	1000
IT9100-CUV6‡	UV Dark Blue								—	—	100	1000
IT9100-CUV6A‡	UV Light Blue								—	—	100	1000
IT9100-CUV6B ‡	UV Cobalt Blue								—	—	100	1000
IT9100-CUV7A‡	UV Purple								—	—	100	1000
IT9100-CUV8‡	UV Silver								—	—	100	1000
IT9100-CUV11‡	UV Teal								—	—	100	1000
IT9100-CUV16B ‡	UV Pink								—	—	100	1000
IT9115-CUV2‡	UV Red								15.3 (389)	.350 (8.9)	.065 (1.7)	.300 (7.6)
IT9115-CUV4‡	UV Yellow	—	—	100	1000							
IT9115-CUV4A ‡	UV Butterscotch	—	—	100	1000							
IT9115-CUV5A‡	UV Green	—	—	100	1000							
IT9115-CUV5B‡	UV Hunter Green	—	—	100	1000							
IT9115-CUV6‡	UV Dark Blue	—	—	100	1000							
IT9115-CUV6A‡	UV Light Blue	—	—	100	1000							
IT9115-CUV6B‡	UV Cobalt Blue	—	—	100	1000							
IT9115-CUV7A‡	UV Purple	—	—	100	1000							
IT9115-CUV8‡	UV Silver	—	—	100	1000							
IT9115-CUV11‡	UV Teal	—	—	100	1000							
IT9115-CUV16B‡	UV Pink	—	—	100	1000							

### Black Cable Ties

IT940-C0‡	UV Black	6.8 (173)	.350 (8.9)	.065 (1.7)	.300 (7.6)	.556 (14.1)	1.57 (40)	124 (550)	—	—	100	1000
IT965-C0‡	UV Black	10.1 (257)					2.58 (65)		—	—	100	1000
IT9100-C0‡	UV Black	14.1 (358)					3.94 (100)		—	—	100	1000
IT9115-C0‡	UV Black	15.3 (388)					4.53 (115)		—	—	100	1000
IT9150-C0‡	UV Black	20.1 (511)					5.91 (150)		—	—	100	1000
IT9250-C0‡	UV Black	33.0 (838)	.075 (1.9)	.320 (8.1)	9.84 (250)	—	—	100	1000			

# PANDUIT® Part Number Suffix Code for All Parallel Entry Cable Ties

## Part Number System (Example of ILT1M-M)

ILT

1

M

—

M

### Part Description:

CBR = *CONTOUR-TY*®  
 ILT = *BELT-TY*™ In-Line Tie  
 IT = In-Line Tie

### Size:

Approximate  
 Maximum Bundle  
 Diameter in  
 Inches

### Cross Section:

M = Miniature  
 I = Intermediate  
 S = Standard  
 HS = Heavy-Standard  
 LH = Light-Heavy

### Package Size:

C = 100  
 TL = 250  
 D = 500  
 M = 1000

### Color:

See Material/Color  
 chart. Not all ties  
 available in all colors.

## Material/Color Chart

Material/Color	PANDUIT® Suffix*	Mil Spec Suffix**
Nylon 6.6 — Natural (See Note)	✓	9
Weather Resistant Nylon 6.6 — Black	0	N/A
Ultraviolet Red	UV2	N/A
Ultraviolet Yellow	UV4	N/A
Ultraviolet Butterscotch	UV4A	N/A
Ultraviolet Green	UV5A	N/A
Ultraviolet Hunter Green	UV5B	N/A

Material/Color	PANDUIT® Suffix*	Mil Spec Suffix**
Ultraviolet Dark Blue	UV6	N/A
Ultraviolet Light Blue	UV6A	N/A
Ultraviolet Cobalt Blue	UV6B	N/A
Ultraviolet Purple	UV7A	N/A
Ultraviolet Silver	UV8	N/A
Ultraviolet Teal	UV11	N/A
Ultraviolet Pink	UV16B	N/A
Ultraviolet Tan	UV18	N/A

\* NOTE: ✓ designates PANDUIT® standard Natural Nylon 6.6 color/material. No suffix required in part number.

\*\* NOTE: MIL SPEC Color (suffix) per AS33671 (Formerly MS3367) and SAE AS33681 (Formerly MS3368).

Standard Packaging			Bulk Packaging		
Part Number	Natural Nylon 6.6	Available Color/ Material (Suffix)	Part Number	Natural Nylon 6.6	Available Color/ Material (Suffix)
			CBR1M-M	✓	0
			CBR1.5M-M	✓	0
			CBR2M-M	✓	0
			CBR1.5I-M	✓	0
			CBR3I-M	✓	0
			CBR4I-M	✓	0
			CBR2S-M	✓	0, 39
			CBR3S-M	✓	0
			CBR4S-M	✓	0
			CBR2HS-D	✓	0
			CBR4LH-TL	✓	0
			CBR6LH-C	✓	0
			ILT1M-M	✓	0
			ILT1.5I-M	✓	0
ILT2S-C	✓	0	ILT2S-M	✓	0
ILT3S-C	✓	0	ILT3S-M	✓	0
ILT4S-C	✓	0	ILT4S-M	✓	0
			ILT4LH-TL	✓	0
			ILT6LH-C	✓	0
			IT940-C		0
			IT965-C		0
			IT9100-C		0, UV2, UV4, UV6, UV6A, UV7A, UV8, UV16B
			IT9115-C		0, UV2, UV4, UV4A, UV5A, UV5B, UV6, UV6A, UV6B, UV7A, UV8, UV11, UV16B, UV18
			IT9150-C		0
			IT9250-C		0

## TAK-TY® Hook & Loop Cable Ties

- Releasable and reusable hundreds of times
- No risk of over tensioning and damaging high performance cabling
- No installation tool needed
- No waste — excess can be wrapped around bundle
- Cinch ties — Pass hook portion through plastic cinch ring. Pull end of tie against ring to tension. Secure hook portion against loop portion of tie body to fasten
- Loop and Strip ties have hooks on one side and loops on the other, so it adheres to itself; wrap around bundle and secure end of tie on the body
- HLM-15R can be used with ABM3H-A-L, ABM4H-A-L, TM3S8-C, TM3S10-C and TM3S25-C mounts
- Loop and Strip ties (in black and maroon) are UL Listed for use in air handling spaces per NEC section 300-22 (c) and (d) and are UL94V-2 flame rated



Color Chart		
Color	Part Number Suffix	Example
Black	0	HLT2I-X0
Red	2	HLT2I-X2
Orange	3	HLT2I-X3
Yellow	4	HLT2I-X4
Green	5	HLT2I-X5
Blue	6	HLT2I-X6
Gray	8	HLT2I-X8
White	10	HLT2I-X10
Maroon	12	HLT2I-X12

### HLC Series

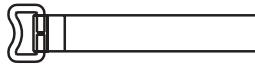

### HLT/HLTP Series

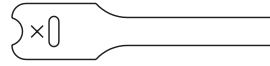

### HLS/HLSP/HLM Series

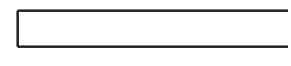

### CINCH TIES — CINCH RING PROVIDES EXTRA STRENGTH AND BUNDLE TIGHTNESS

Part Number	Length in. (mm)	Width in. (mm)	Thickness in. (mm)	Head Width in. (mm)	Min. Bundle Dia. in. (mm)	Max. Bundle Dia. in. (mm)	Min. Loop Tensile Strength* Lbs. (N)	Packaging**	
								Std. Pkg. Qty.	Std. Ctn. Qty.
<b>HLC3S-X0</b>	12.0 (305)	.750 (19.1)	.10 (2.5)	1.10 (27.9)	2.00 (51)	3.00 (76)	50 (222)	10	100
<b>HLC5S-X0</b>	18.0 (457)							10	100

### LOOP TIES — SLOT ALLOWS FOR PRE-WRAPPING OF BUNDLES

Part Number	Length in. (mm)	Width in. (mm)	Thickness in. (mm)	Head Width in. (mm)	Min. Bundle Dia. in. (mm)	Max. Bundle Dia. in. (mm)	Min. Loop Tensile Strength* Lbs. (N)	Packaging**	
								Std. Pkg. Qty.	Std. Ctn. Qty.
<b>HLT2I-X0</b>	8.0 (203)	.50 (12.7)	.10 (2.5)	1.00 (25.4)	.25 (6)	1.91 (49)	40 (178)	10	100
<b>HLT3I-X0</b>	12.0 (305)							10	100

### UL LISTED LOOP TIES \*\* — LARGER

<b>HLTP2I-X12</b>	8.0 (203)	.50 (12.7)	.10 (2.5)	1.00 (25.4)	.25 (6)	1.91 (49)	40 (178)	10	100
<b>HLTP3I-X12</b>	12.0 (305)							10	100

### STRIP TIES — ROLLS PERFORATED IN CONVENIENT 6", 12" AND 18" STRIPS

Part Number	Length in. (mm)	Width in. (mm)	Thickness in. (mm)	Head Width in. (mm)	Min. Bundle Dia. in. (mm)	Max. Bundle Dia. in. (mm)	Min. Loop Tensile Strength* Lbs. (N)	Packaging**	
								Std. Pkg. Qty.	Std. Ctn. Qty.
<b>HLS1.5S-X0</b>	6.0 (152)	.750 (19.1)	.10 (2.5)	—	.25 (6)	1.50 (38)	50 (222)	10	100
<b>HLS3S-X0</b>	12.0 (305)							10	100
<b>HLS5S-X0</b>	18.0 (457)							10	100

### UL LISTED STRIP TIES \*\* — LARGER

<b>HLSP1.5S-X12</b>	6.0 (152)	.750 (19.1)	.10 (2.5)	—	.25 (6)	1.50 (38)	50 (222)	10	100
<b>HLSP3S-X12</b>	12.0 (305)							10	100
<b>HLSP5S-X12</b>	18.0 (457)							10	100

### 15' & 75' ROLLS — CAN BE CUT TO DESIRED LENGTH, ELIMINATING WASTE

Part Number	Length in. (mm)	Width in. (mm)	Thickness in. (mm)	Head Width in. (mm)	Min. Bundle Dia. in. (mm)	Max. Bundle Dia. in. (mm)	Min. Loop Tensile Strength* Lbs. (N)	Packaging**	
								Std. Pkg. Qty.	Std. Ctn. Qty.
<b>HLM-15R0</b>	180.0 (4572)	.33 (8.4)	.10 (2.5)	—	.25 (6)	Various	18 (80)	1	10
<b>HLS-15R0</b>	180.0 (4572)	.750 (19.1)					1	10	
<b>HLS-75R0</b>	900.0 (22,860)	.750 (19.1)					1	10	

\*Minimum 2" overlap required to achieve loop tensile rating (HLC, HLT, HLS, HLM series).

\*\*Available in -0 (Black) rated 18lbs. (80N).



# PANDUIT® TAK-TY® Hook & Loop Grommet Cinch Ties

## TAK-TY® Hook & Loop Grommet Cinch Ties

- Sturdy brass grommet and washer provides strength and high visibility for mounting in poor lighting conditions
- 1/4" (M6) diameter mounting hole fits drywall screws up to #12 screw size
- Grommet allows for mounting of the cinch ties prior to cable installation for easier handling of cable bundles with tie pre-positioned and anchored
- No sharp edges to damage cables
- Releasable and Reusable



Part Number	Length in. (mm)	Width in. (mm)	Thickness in. (mm)	Head Width in. (mm)	Max. Bundle Dia. in. (mm)	Min. Loop Tensile Strength Lbs. (N)*	Packaging**			
							Std. Pkg. Qty.**	Std. Ctn. Qty.**	Bulk Pkg. Qty.	Bulk Ctn. Qty.
<b>GCTC SERIES — GROMMET CINCH TIE CENTER MOUNT (Centers bundle over mounting point)</b>										
GCTC3S-X0	12.0 (305)	.750 (19.1)	.10 (2.5)	1.10 (27.9)	3.00 (76.2)	30 (133)	10	100	—	—
GCTC5S-X0	18.0 (457)				5.00 (127)	50 (222)	10	100	—	—
<b>GCTE SERIES — GROMMET CINCH TIE END MOUNT (Offsets bundle next to mounting point)</b>										
GCTE2S-X0	10.5 (267)	.750 (19.1)	.10 (2.5)	1.10 (27.9)	2.20 (55.8)	50 (222)	10	100	—	—
GCTE4S-X0	16.5 (419)				4.10 (104.1)		10	100	—	—

\*Tensile Strength achieved with 2" overlap.

# PANDUIT® Part Number Suffix Codes for All Hook & Loop Cable Ties

## Part Number System (Example of HLC3S-X0)

HLC	3	S	—	X	0
<b>Part Description:</b> HL = Hook & Loop HLC = H&L Cinch Tie HLT = H&L Tie HLTP* = H&L Tie Plenum HLS = H&L Strip HLSP* = H&L Strip Plenum HLM = H&L Strip Miniature GCT = Grommet Cinch Tie	<b>Size:</b> Approximate Maximum Bundle Diameter in Inches	<b>Cross Section:</b> I = Intermediate S = Standard		<b>Package Size:</b> X = 10 15R = 15' Roll 75R = 75' Roll	<b>Color:</b> See Material/ Color chart. Not all ties available in all colors.

## Material/Color Chart

Color	PANDUIT® Suffix
Black	0
Red	2
Orange	3
Yellow	4
Green	5

Color	PANDUIT® Suffix
Blue	6
Gray	8
White	10
Maroon	12

Standard Packaging	
Part Number	Available Color/ Material (Suffix)
GCTC3S-X	0
GCTC5S-X	0
GCTE2S-X	0
GCTE4S-X	0
HLC3S-X	0
HLC5S-X	0
HLM-15R	0, 2, 3, 4, 5, 6, 8, 10
HLS-15R	0, 2, 3, 4, 5, 6, 8, 10
HLS-75R	0, 2, 3, 4, 5, 6, 8, 10
HLS1.5S-X	0, 2, 3, 4, 5, 6, 8, 10
HLS3S-X	0, 2, 3, 4, 5, 6, 8, 10
HLS5S-X	0, 2, 3, 4, 5, 6, 8, 10
HLT2I-X	0, 2, 3, 4, 5, 6, 8, 10
HLT3I-X	0, 2, 3, 4, 5, 6, 8, 10
*HLSP1.5S-X	0,12
*HLSP3S-X	0,12
*HLSP5S-X	0,12
*HLTP2I-X	0,12
*HLTP3I-X	0,12

\*HLSP and HLTP are unique Hook & Loop style ties that are UL Listed for use in air-handling spaces per NEC section 300-22 (c) and (d) and are UL94V-2 flame rated. Available in Black (-X0) and Maroon (-X12).

# PANDUIT® STA-STRAP® Cable Ties (SSC/SST Series)

## STA-STRAP® Nylon 6.6 Cable Ties

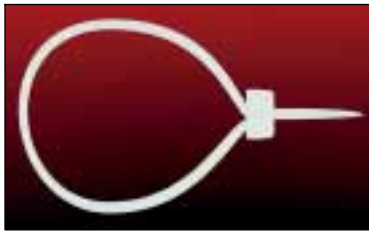

- STA-STRAP® Cable Ties — Use for normal bundling and through-panel applications
- STA-STRAP® Clamp Ties — Only clamp that can be pre-mounted before tying bundle
- Low profile head for use in compact areas
- Two piece design provides low thread force to reduce installer fatigue
- Lower weight than comparable one-piece ties
- Releasable (prior to final tensioning and cut-off) — Helpful in assembly

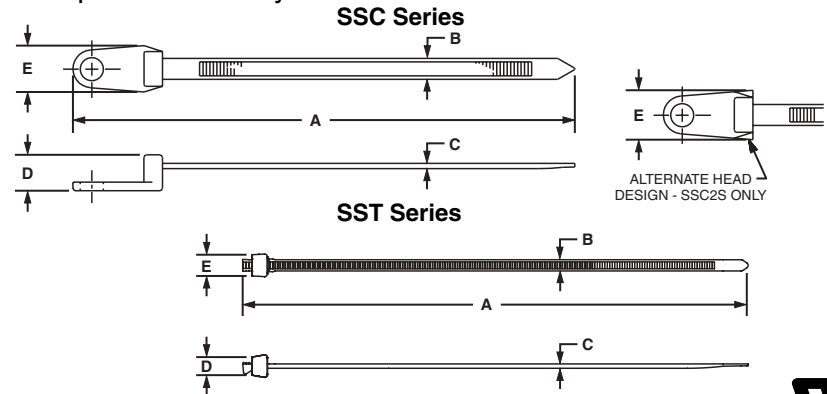

### STA-STRAP® Clamp Head Cable Ties — SSC Series

Part Number	Length A in. (mm)	Width B in. (mm)	Thickness C in. (mm)	Boss Height D in. (mm)	Boss Width E in. (mm)	Max. Bundle Dia. in. (mm)	Min. Loop Tensile Strength Lbs. (N)	Screw Size	Recommended PANDUIT® Installation Tool Part No.	Packaging*			
										Std. Pkg. Qty.	Std. Ctn. Qty.	Bulk Pkg. Qty.	Bulk Ctn. Qty.

#### STANDARD CROSS SECTION

SSC2S-S10-C	7.4 (187)	.180 (4.6)	.045 (1.2)	.310 (7.9)	.430 (10.9)	1.75 (45)	50 (222)	#10 (M5)	GTS, GS2B, GTH, GS4H, PTS or PPTS	100	100	1000	1000
-------------	--------------	---------------	---------------	---------------	----------------	--------------	-------------	-------------	-----------------------------------	-----	-----	------	------

#### HEAVY CROSS SECTION

SSC4H-S25-L	15.6 (395)	.300 (7.6)	.065 (1.5)	.460 (11.7)	.53 (13.5)	4.00 (102)	120 (534)	1/4 (M6)	GTH, GS4H, GS4EH or PPTEH	50	500	500	2500
-------------	---------------	---------------	---------------	----------------	---------------	---------------	--------------	-------------	---------------------------	----	-----	-----	------

### STA-STRAP® Cable Ties — SST Series

Part Number	Length A in. (mm)	Width B in. (mm)	Thickness C in. (mm)	Head Height D in. (mm)	Head Width E in. (mm)	Max. Bundle Dia. in. (mm)	Min. Loop Tensile Strength Lbs. (N)	Recommended PANDUIT® Installation Tool Part No.	Packaging*			
									Std. Pkg. Qty.	Std. Ctn. Qty.	Bulk Pkg. Qty.	Bulk Ctn. Qty.

#### MINIATURE CROSS SECTION

SST1M-C	4.0 (102)	.095 (2.4)	.035 (.9)	.150 (3.8)	.175 (4.5)	.78 (20)	18 (80)	GTS, GS2B, PTS or PPTS	100	1000	1000	50000
SST1.5M-C	5.5 (140)		.037 (.9)			1.25 (32)			100	1000	1000	50000

#### INTERMEDIATE CROSS SECTION

SST1.5I-C	5.3 (137)	.135 (3.4)	.037 (.9)	.210 (5.3)	.240 (6.1)	1.25 (32)	40 (178)	GTS, GS2B, PTS or PPTS	100	1000	1000	25000
SST2I-C	8.1 (206)		.040 (1.0)			2.00 (50)			100	1000	1000	25000
SST3I-C	11.0 (279)		3.00 (76)			100			1000	1000	10000	

#### STANDARD CROSS SECTION

SST2S-C	6.7 (172)	.180 (4.6)	.045 (1.2)	.250 (6.4)	.310 (7.9)	1.75 (45)	50 (222)	GTS, GS2B, GTH, GS4H, PTS, PPTS, STS2 or STH2	100	1000	1000	15000
SST3S-C	11.0 (279)		.048 (1.2)			3.00 (76)			100	1000	1000	10000
SST4S-C	15.0 (381)		.253 (6.4)			.350 (8.9)			4.00 (102)	100	1000	1000

#### HEAVY CROSS SECTION

SST4H-D‡	14.8 (376)	.300 (7.6)	.067 (1.7)	.325 (8.3)	.460 (11.7)	4.00 (102)	120 (534)	GTH, GS4H, GS4EH or PPTEH	—	—	500	2500
SST8H-D‡	27.5 (699)					8.00 (203)			—	—	500	2000

\*Order the number of pieces required in multiples of package quantities.  
 For colors and other materials, see page 45.  
 All part numbers shown in standard package quantities unless denoted by ‡.

## STA-STRAP® Chassis/Panel Mount Tie — Weather Resistant Heat Stabilized Nylon 6.6



### Applications:

- Run cable and hose along truck frame rails
- Secure a bundle under a chassis assembly
- Manage wire harnesses in the cab and sleeper
- Use a through-hole in frame/chassis to mount

### Solution:

PANDUIT® STA-STRAP® Chassis Mount Ties are uniquely designed to secure a bundle directly to a chassis or panel utilizing a through-hole.

### Features:

- Eliminates the need for separate fasteners to reduce costs and decrease installation time
- Remains adjustable and releasable until tie is tensioned and cut-off
- Installs easily with PANDUIT® hand-operated tools
- Engages clearance hole with optional centering pilot (2 designs) to prevent tie from shifting or abrading during vehicle operation

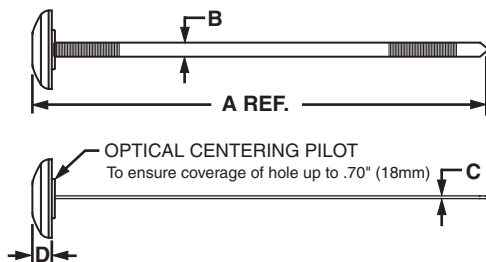

Without Pilot      With Pilot      With Long Centering Pilot

- Optional Long Centering Pilot
- Pilot ears protect strap body from clearance hole edges

### Three Easy Steps...

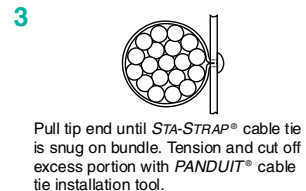
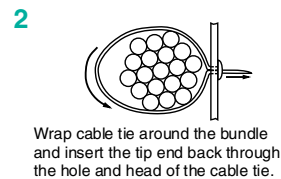
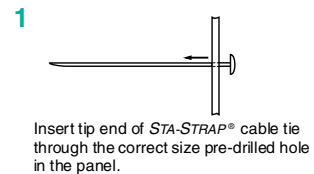

### HEAVY CROSS SECTION

Part Number	A Length in. (mm)	B Width in. (mm)	C Thickness in. (mm)	D Head Height in. (mm)	Recommended Panel Hole Dia. in. (mm)	Maximum Bundle Diameter in. (mm)	Min. Loop Tensile Strength Lbs. (N)	Recommended PANDUIT® Installation Tool Part No.	Packaging*				
									Std. Pkg. Qty.	Std. Ctn. Qty.	Bulk Pkg. Qty.	Bulk Ctn. Qty.	
<b>WITHOUT PILOT</b>													
<b>SSPM2.5H-L300</b>	10.1 (257)	.30 (7.6)	.062 (1.6)	.248 (6.3)	.316 to .820 (8.0 to 21)	2.76 (70)	120 (534)	GTH, GS4H, GS4EH, PPTEH, STH2 or ST2EH	50	2500	250	2500	
<b>SSPM4H-L300</b>	14.8 (376)								50	2500	250	2500	
<b>WITH PILOT</b>													
<b>SSPM2.5HP-L300</b>	10.1 (257)	.30 (7.6)	.062 (1.6)	.248 (6.3)	.440 to .820 (11.2 to 21)	2.76 (70)	120 (534)	GTH, GS4H, GS4EH, PPTEH, STH2 or ST2EH	50	2500	250	2500	
<b>SSPM4HP-L300</b>	14.8 (376)								50	2500	250	2500	
<b>WITH LONG CENTERING PILOT</b>													
<b>SSPM4HLP-TL300‡</b>	14.8 (376)	.30 (7.6)	.062 (1.6)	.248 (6.3)	.440 to .820 (11.2 to 21)	4.00 (102)	120 (534)	GTH, GS4H, GS4EH, PPTEH, STH2 or ST2EH	—	—	250	2500	



# PANDUIT® Part Number Suffix Codes for All STA-STRAP® Cable Ties

## Part Number System (Example of SST1M-C)

SST

1

M

—

C

### Part Description:

SST = STA-STRAP® Tie  
 SSC = STA-STRAP® Clamp  
 SSPM = STA-STRAP® Panel Mount  
 SSB = STA-STRAP® Bow-Ty  
 SSM = STA-STRAP® Marker

### Size:

Approximate  
 Maximum Bundle  
 Diameter in  
 Inches

### Cross Section:

M = Miniature  
 I = Intermediate  
 S = Standard  
 LH = Light-Heavy  
 H = Heavy  
 HH = Heavy Head

### Screw Hole Size: (Clamp Ties Only)

-S6 = #6 (M3)  
 -S10 = #10 (M5)  
 -S25 = 1/4 (M6)

### Package Size:

L = 50  
 C = 100  
 TL = 250  
 D = 500  
 M = 1000

### Color:

See  
 Material/  
 Color chart.  
 Not all ties  
 available in  
 all colors.

## Material/Color Chart

Material/Color	PANDUIT® Suffix*	Mil Spec Suffix**
Nylon 6.6 — Natural (see note)	✓	9
Weather Resistant Nylon 6.6 — Black	0	N/A
Nylon 6.6 — Black	20	N/A

Material/Color	PANDUIT® Suffix*	Mil Spec Suffix**
Heat Stabilized Nylon 6.6 — Black	30	N/A
Heat Stabilized Weather Resistant Nylon 6.6 — Black	300	N/A

\*NOTE: ✓ designates PANDUIT® standard Natural Nylon 6.6 color material. No suffix required in part number.

\*\*NOTE: MIL SPEC Color (suffix) per AS33671 (Formerly MS3367) and SAE AS33681 (Formerly MS3368).

Standard Packaging			Bulk Packaging		
Part Number	Natural Nylon 6.6	Available Color/ Material (Suffix)	Part Number	Natural Nylon 6.6	Available Color/ Material (Suffix)
SSPM2.5H-L		300	SSPM2.5H-TL		300
SSPM2.5HP-L		300	SSPM2.5HP-TL		300
SSPM4H-L		300	SSPM4H-TL		300
SSPM4HP-L		300	SSPM4HP-TL		300
			SSPM4HLP-TL		300
SSC2S-S10-C	✓		SSC2S-S10-M	✓	0, 30
SSC2S-S6-C	✓		SSC2S-S6-M	✓	0
SSC4S-S10-C	✓		SSC4S-S10-M	✓	0
SSC4H-S25-L	✓		SSC4H-S25-D	✓	0
SSM2S-C	✓		SSM2S-D	✓	0
			SSM4S-D	✓	
SST1M-C	✓	0	SST1M-M	✓	0, 20, 30
SST1.5M-C	✓		SST1.5M-M	✓	0, 20, 30
SST1.5I-C	✓		SST1.5I-M	✓	0
SST2I-C	✓		SST2I-M	✓	0, 20
SST3I-C	✓	0	SST3I-M	✓	0
SST4I-C	✓		SST4I-M	✓	0
			SST1.5S-M	✓	0
SST2S-C	✓	0	SST2S-M	✓	0, 20, 30
SST3S-C	✓	0	SST3S-M	✓	0, 20, 30
SST4S-C	✓	0	SST4S-M	✓	0, 2, 30
			SST2H-D	✓	0
SST4H-L	✓	0	SST4H-D	✓	0, 30
			SST4HH-D		30
SST8H-L	✓	0	SST8H-D	✓	0, 30
SSB2S-C	✓		SSB2S-M	✓	0, 30

**PANDUIT® Stud Mounted Heat Stabilized Nylon 6.6 Cable Ties**

Base portion pushes onto a threaded stud and the tie portion wraps around the bundle. The wire bundle is centered over the stud.

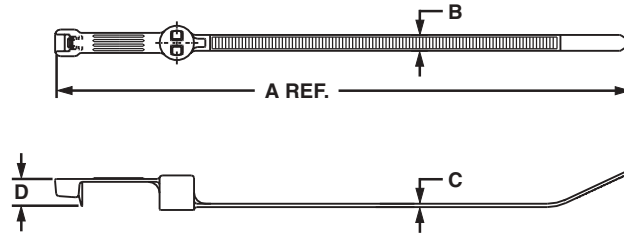

Part Number	Length A in. (mm)	Width B in. (mm)	Thickness C in. (mm)	Head Height D in. (mm)	Recommended Stud Size in. (mm)	Max. Bundle Dia. in. (mm)	Min. Loop Tensile Strength Lbs. (N)	Recommended PANDUIT® Installation Tool Part No.	Packaging*			
									Std. Pkg. Qty.	Std. Ctn. Qty.	Bulk Pkg. Qty.	Bulk Ctn. Qty.
<b>STANDARD CROSS SECTION</b>												
PLST30SC-D30‡	5.74 (146)	.19 (4.8)	.050 (1.3)	.41 (10.5)	10-24 (5)	1.18 (30)	50 (222)	GTS, GS2B GTH, GS4H, PTS, PPTS, STS2 or STH2	—	—	500	5000
PLST50SC-D30‡	8.14 (207)					1.97 (50)			—	—	500	5000
<b>HEAVY CROSS SECTION</b>												
PLST4HS25-TL300‡	15.3 (389)	.300 (7.6)	.075 (1.9)	.265 (6.7)	1/4-20 (6)	4.00 (102.1)	120 (534)	GTH, GS4H, GS4EH or PPTEH	—	—	250	2500

**Ladder Style Stud Mounted Cable Tie Heat Stabilized Nylon 6.6**

The ties can be removed from the stud by turning counterclockwise. Adjustable and releasable.

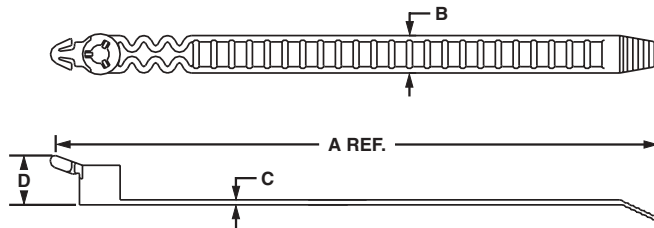
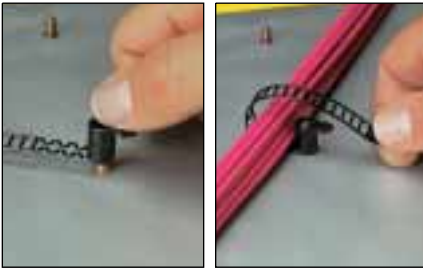

Part Number	Length A in. (mm)	Width B in. (mm)	Thickness C in. (mm)	Head Height D in. (mm)	Recommended Stud Size in. (mm)	Max. Bundle Dia. in. (mm)	Min. Loop Tensile Strength Lbs. (N)	Recommended PANDUIT® Installation Tool Part No.	Packaging*			
									Std. Pkg. Qty.	Std. Ctn. Qty.	Bulk Pkg. Qty.	Bulk Ctn. Qty.
<b>STANDARD CROSS SECTION</b>												
PRST30S-S14-M30‡	5.2 (132)	.38 (9.7)	.050 (1.3)	.59 (15)	10-24 (5)	1.18 (30)	35 (156)	Hand Installed Only	—	—	1000	10000

## PANDUIT® Multiple Loop Cable Ties — Nylon 6.6



**UL**  
C **UL** US  
Except PLB4H-0

### Applications:

- Underhood hose and harness routing
- Areas where bundles must be secured parallel to each other or another element

### Solution

Looking for a labor saving alternative to cushioned clamps when securing hoses and wire bundles? PANDUIT® Multiple Loop Cable Ties are the perfect solution.

### Features and Benefits:

- Offers multiple loop capability
- Prevents bundle damage with a wire strap body that spreads the clamping forces
- Provides high tensile strength to route bundles securely
- Installs easily by hand — use PANDUIT® tooling for repeatable tension and cut-off
- Reduces part number inventory with a single product to cover multiple bundle sizes

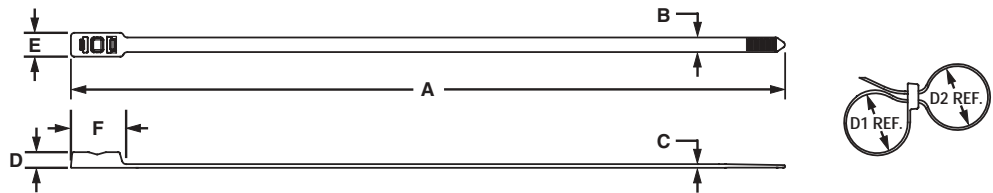

Part Number	Max. Combined Bundle dia. D1 & D2 in. (mm)	Length A in. (mm)	Width B in. (mm)	Thickness C in. (mm)	Head Height D in. (mm)	Head Width E in. (mm)	Head Length F in. (mm)	Min. Loop Tensile Strength Lbs. (N)	Recommended PANDUIT® Installation Tool Part No.	Packaging*			
										Std. Pkg. Qty.	Std. Ctn. Qty.	Bulk Pkg. Qty.	Bulk Ctn. Qty.

### STANDARD CROSS SECTION

<b>PLB2S-C</b>	1.8 (46)	7.6 (193)	.19 (4.8)	.052 (1.3)	.220 (5.6)	.320 (8.1)	.465 (11.8)	50 (222)	GTS, GS2B, GTH, GS4H, PTS, PPTS, STS2 or STH2	100	1000	1000	10000
<b>PLB3S-C</b>	3.0 (76)	11.8 (300)				.337 (8.6)				100	1000	1000	10000
<b>PLB4S-C</b>	4.1 (104)	14.8 (376)				100				1000	1000	5000	

### HEAVY CROSS SECTION

<b>PLB4H-TL‡</b>	3.6 (91)	14.7 (373)	.300 (7.6)	.075 (1.9)	.322 (8.2)	.490 (12.4)	1.1 (27.9)	120 (534)	GTH, GS4H, GS4EH, or PPTEH	—	—	250	2500
<b>PLB4H-TL0‡</b>										—	—	250	2500



## PANDUIT® Multiple Loop Cable Ties — Weather Resistant Nylon 6.6

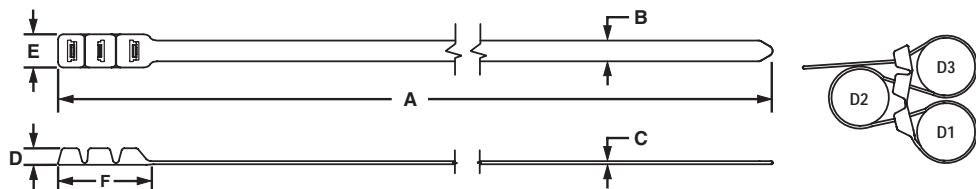

Part Number	Max. Combined Bundle Dia. D1, D2 & D3 in. (mm)	Length A in. (mm)	Width B in. (mm)	Thickness C in. (mm)	Head Height D in. (mm)	Head Width E in. (mm)	Head Length F in. (mm)	Min. Loop Tensile Strength Lbs. (N)	Recommended PANDUIT® Installation Tool Part No.	Packaging*			
										Std. Pkg. Qty.	Std. Ctn. Qty.	Bulk Pkg. Qty.	Bulk Ctn. Qty.

### EXTRA-HEAVY CROSS SECTION

<b>PL3B5EH-C0‡</b>	5.0 (127)	20.0 (508)	.500 (12.7)	.075 (1.9)	.400 (10.2)	.800 (20.3)	1.8 (45.7)	125 (556)	GS4EH or PPTEH	—	—	100	1000
--------------------	-----------	------------	-------------	------------	-------------	-------------	------------	-----------	----------------	---	---	-----	------

\*Order the number of pieces required in multiples of package quantities.  
For colors and other materials, see page 50.  
All part numbers shown in standard package quantities unless denoted by ‡.

## Double Hose Clamp Weather Resistant Nylon 6.6

The Double Hose Clamp can be used on gasoline, hydraulic or pneumatic hoses. It holds each hose individually to prevent abrasion and holds them together to prevent twisting.

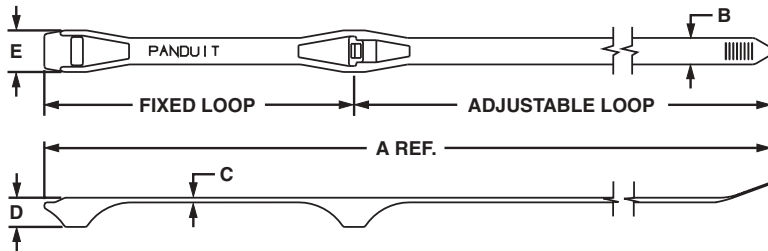

Part Number	Length A in. (mm)	Width B in. (mm)	Thickness C in. (mm)	Head Height D in. (mm)	Head Width E in. (mm)	Loop Diameters		Min. Loop Tensile Strength Lbs. (N)	Recommended PANDUIT® Installation Tool Part No.	Packaging*			
						Fixed Loop in. (mm)	Adjustable Loop in. (mm)			Std. Pkg. Qty.	Std. Ctn. Qty.	Bulk Pkg. Qty.	Bulk Ctn. Qty.
DHC1.12x1.75-D0	11.0 (279)	.28 (7.1)	.050 (1.3)	.31 (7.9)	.44 (11.2)	1.12 (28.4)	1.0 to 1.75 (25 to 44)	100 (445)	GTH, GS4H, STH2 or ST2EH	—	—	500	2500

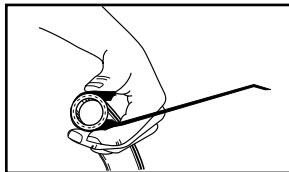

1. Wrap clamp around hose.

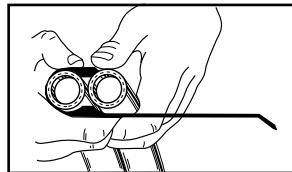

2. Position second hose in clamp.

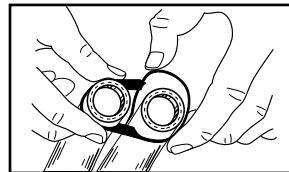

3. Loop tail around second hose and thread tail through both spacer heads.

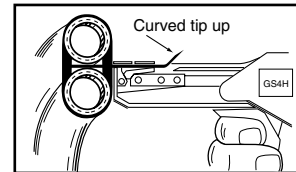

4. Tension and cut off with PANDUIT® tool.



## Polyethylene Cable Marker Strap



For identifying telephone and fiber optic cable. Replaces costly and cumbersome lead marking tags. Lightweight and easy-to-install. Can be used as wrap-around or “flag” marker. Can also be used in underground identification applications. Custom hot stamping is available (see page 52).

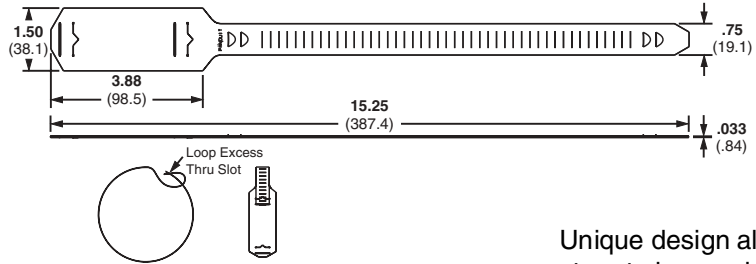

Unique design allows strap to be used as:



WRAP-AROUND MARKER  
(Min. Dia.: 1.27")



“FLAG” MARKER  
(Min. Dia.: .25")

Part Number	Color	Marking Area in. (mm.)	Max. Bundle Dia. in. (mm)	Recommended PANDUIT® Installation Tool Part No.	Packaging*	
					Std. Pkg. Qty.	Std. Ctn. Qty.
CM4S-L2	Red	1.50 x 2.62 (38.1 x 66.5)	4.38 (111)	Hand Installed Only	50	500
CM4S-L8	Gray				50	500

\*Order the number of pieces required in multiples of package quantities.  
For colors and other materials, see page 50.  
All part numbers shown in standard package quantities unless denoted by ‡.

# PANDUIT® Part Number Suffix Codes for All PANDUIT® Specialty Cable Ties

## Part Number System (Example of PLST4HS25-TL)

PLST                      4                      H                      S25                      –                      TL

**Part Description:**

CM4S = Cable Marker Strap  
 DHC = Double Hose Clamp  
 PLST = Lock. Stud Mounted  
 PLB = Locking Bow Tie  
 PRST = Releas. Stud Mounted  
 (Ladder Style)

**Size:**

Approximate  
 Maximum Bundle  
 Diameter in Inches

**Cross Section:**

S = Standard  
 H = Heavy  
 EH = Extra-Heavy

**Stud Size:**

-S25 = 1/4" (M6)  
 -SC = .20" (5mm)

**Package Size:**

L = 50  
 C = 100  
 TL = 250  
 D = 500

**Color:**

See Material/  
 Color chart. Not  
 all ties available  
 in all colors.

## Material/Color Chart

Material/Color	PANDUIT® Suffix*	Mil Spec Suffix**	Material/Color	PANDUIT® Suffix*	Mil Spec Suffix**
Natural Nylon 6.6 (See Note)	✓	9	Nylon 6.6 — Gray	8	8
Weather Resistant Nylon 6.6	0	N/A	Heat Stabilized Black Nylon 6.6	30	N/A
Nylon 6.6 — Red	2	2	Heat Stabilized Weather Resistant Nylon 6.6	300	N/A

\*NOTE: ✓ designates PANDUIT® standard Natural Nylon 6.6 color/material. No suffix required in part number.

\*\*NOTE: MIL SPEC Color (suffix) per AS33671 (Formerly MS3367) and SAE AS33681 (Formerly MS3368).

Standard Packaging			Bulk Packaging		
Part Number	Natural Nylon 6.6	Available Color/ Material (Suffix)	Part Number	Natural Nylon 6.6	Available Color/ Material (Suffix)
CM4S-L		2, 8			
			DHC1.12X1.75-D		0
PLB2S-C	✓	0	PLB2S-M	✓	0, 30
PLB3S-C	✓	0	PLB3S-M	✓	0, 30
PLB4S-C	✓		PLB4S-M	✓	0, 30
			PLB4H-TL	✓	0, 30
			PL3B5EH-C		0
			PLST4HS25-TL		300
			PLST30SC-D		30
			PLST50SC-D		30
			PRST40SC-D		30

**Aerospace and Military Standard cross reference to *PANDUIT®* part numbers**

The *PANDUIT®* Cable Ties and Marker Ties listed in the table below meet all the testing requirements of Aerospace Standard SAE-AS23190A (formerly MIL-S-23190E) and the dimensional requirements of Aerospace Standards SAE-AS33671 (formerly MS3367) and SAE-AS33681 (formerly MS3368).

<b>Cable Ties</b>				
<b>Current MIL Std. Part Number*</b>	<b><i>PAN-TY®</i> Cable Tie Part Number</b>	<b><i>DOME-TOP®</i> Barb Ty Cable Tie Part Number</b>	<b><i>STA-STRAP®</i> Cable Tie Part Number</b>	<b><i>BELT-TY™</i> In-Line Cable Tie Part Number</b>
MS3367-1-*	PLT2S	BT2S	SST2S	—
MS3367-2-*	PLT4S	BT4S	SST4S	—
MS3367-3-*	PLT4H	BT4LH	SST4H	—
MS3367-4-*	PLT.7M	—	—	—
MS3367-4-*	PLT1M	BT1M	SST1M	—
MS3367-5-*	PLT1.5I	BT1.5I	SST1.5I	—
MS3367-6-*	PLT8LH	BT8LH	SST8H	—
MS3367-6-*	—	BT9LH	—	—
MS3367-7-*	PLT3S	BT3S	SST3S	—
MS3367-23-*	—	—	—	ILT2S
MS3367-24-*	—	—	—	ILT4S
MS3367-25-*	—	—	—	ILT4LH
MS3367-26-*	—	—	—	ILT1M
MS3367-27-*	—	—	—	ILT1.5I
MS3367-29-*	—	—	—	ILT3S

<b>Marker Ties</b>		
<b>Current MIL Std. Part Number*</b>	<b><i>PAN-TY®</i> Cable Tie Part Number</b>	<b><i>DOME-TOP®</i> Barb Ty Cable Tie Part Number</b>
MS3368-1-*	PLM2S	BM2S
MS3368-2-*	PLM4S	BM4S
MS3368-3-*	PL2M2S	B2M2S
MS3368-4-*	PL3M2S	B3M2S
MS3368-5-*	PLM1M	BM1M

The *PANDUIT®* Installation Tools listed in the table below meet all the testing requirements of MIL-T-81306 and the dimensional requirements of MS90387.

<b>Installation Tools</b>	
<b>Current MIL Std. Part Number*</b>	<b>Tool Part Number</b>
MS90387-1	GTS, GS2B
MS90387-2	GS4H
MS90387-3	GS4MT

\* Color Code (See Material/Color Chart located in the back of each product line section).

## PANDUIT® Custom Hot Stamping Program

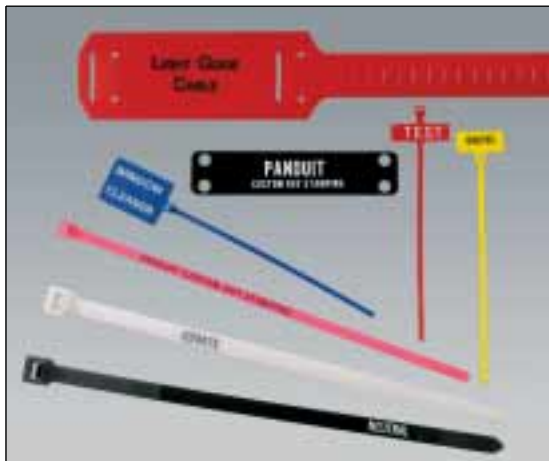

**A custom program to mark nylon cable ties, marker ties and marker plates to suit your application requirements . . .**

- Economical
- Convenient
- 1/8" (3mm), 3/16" (4.8mm), 5/64" (2mm) and 7/64" (2.8mm) characters are available
- Standard Type Style: News Gothic
- Character sizes can be mixed from line-to-line
- Alphanumeric and sequential numbering for serialization are available
- Sequential numbering available in 3/32" (2.4mm), 9/64" (3.6mm), and 1/8" (3mm) characters
- Seven colors of hot stamping to make your message stand out — Black, Blue, Green, Red, Yellow, Orange and White
- Special logos, type styles and sizes can be provided (when camera ready artwork is supplied)
- Minimum order: 5,000 pieces per part number and message

### Cable Tie Cross Sections

INTERMEDIATE  
(Locking)

STANDARD  
(Locking and Releasable)

LIGHT-HEAVY AND HEAVY  
(Locking and Releasable)

EXTRA-HEAVY  
(Locking and Releasable)



### Marker Tie Cross Sections

MINIATURE  
(Locking)

STANDARD  
(Locking)



NOTE: Most cable ties and marker ties are available in colors (See information at the back of each tie section).

**Contact Your Local PANDUIT® Distributor for Details**

# PANDUIT® PAN-POUCH™ Telephone Cable Identification Kit

## PANDUIT® PAN-POUCH™ Telephone Cable Identification Kit



The *PAN-POUCH™* system provides a fast, convenient method of identifying binder groups on both sides of a splice in PIC cable. It consists of striped *PAN-TY®* Cable Ties in 25 color combinations which match the universally accepted Even-Count Color Code. In addition, solid color ties are available for identification of “Super Groups” in cable containing more than 600 pairs. Cable ties have maximum bundle diameter of .82" (21mm). Each 50 pc. package fits into *PAN-POUCH™* over Pocket Pouch.

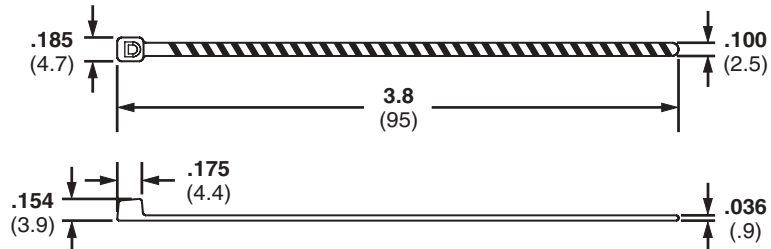

## Nylon 6.6 Cable Ties



Part Number	Cable Tie Color	Color Stripe	Packaging*	
			Std. Pkg. Qty.	Std. Ctn. Qty.
PLT1M-L6-10	Blue	White	50	1000
PLT1M-L3-10	Orange		50	1000
PLT1M-L5-10	Green		50	1000
PLT1M-L1-10	Brown		50	1000
PLT1M-L8-10	Slate		50	1000
PLT1M-L6-2	Blue	Red	50	1000
PLT1M-L3-2	Orange		50	1000
PLT1M-L5-2	Green		50	1000
PLT1M-L1-2	Brown		50	1000
PLT1M-L8-2	Slate		50	1000
PLT1M-L6-0	Blue	Black	50	1000
PLT1M-L3-0	Orange		50	1000
PLT1M-L5-0	Green		50	1000
PLT1M-L1-0	Brown		50	1000
PLT1M-L8-0	Slate		50	1000

Cable ties in other solid colors (sold in 100 pc. packages) see pages 24-26.

Part Number	Cable Tie Color	Color Stripe	Packaging*	
			Std. Pkg. Qty.	Std. Ctn. Qty.
PLT1M-L6-4	Blue	Yellow	50	1000
PLT1M-L3-4	Orange		50	1000
PLT1M-L5-4	Green		50	1000
PLT1M-L1-4	Brown		50	1000
PLT1M-L8-4	Slate		50	1000
PLT1M-L6-7	Blue	Violet	50	1000
PLT1M-L3-7	Orange		50	1000
PLT1M-L5-7	Green		50	1000
PLT1M-L1-7	Brown		50	1000
PLT1M-L8-7	Slate*		50	1000
PLT1M-L2	Red	—	50	1000
PLT1M-L0	Black*		50	1000
PLT1M-L4	Yellow*		50	1000
PLT1M-L6	Blue*	—	50	1000
PLT1M-L3	Orange*		50	1000
PLT1M-L5	Green*		50	1000
PLT1M-L1	Brown*		50	1000
PLT1M-L8	Slate*		50	1000

\*Not included in filled *PAN-POUCH™*.



## Pouches

*PAN-POUCH™* is 10 1/2" x 38" (267mm x 965mm) made of 2 ply laminated black nylon/vinyl and folds to 10 1/2" x 6" (266mm x 152mm) for easy storage. The pouch can be easily hung from cable by using Hook & Loop fasteners.



Pocket Pouch holds five (50 pc.) packages.

Part Number	Description	Pouch Material	Packaging*
			Std. Pkg. Qty.
PPC25x50F	<i>PAN-POUCH™</i> filled with 1250 cable ties. 50 each of all 24 striped ties plus solid red.	2 ply Laminated Black Nylon/Vinyl	1
PPC25x50	Empty <i>PAN-POUCH™</i>		1
PP5x50F	Pocket Pouch filled with 250 cable ties. 50 each: blue, orange, green, brown and slate all with white stripe.	Vinyl	1

\*Order by the number of pieces required in multiples of package quantities. All part numbers shown in standard package quantities unless denoted by †.

## Cable Tie Kits in Plastic Boxes — KP-506A/KP-506A-0 Cable Ties and Accessories Kit



## KP-509 Designer's Kit



## Cable Tie Kits in Steel Boxes — K-504 Cable Ties and Accessories Kit



## K-205 Cable Ties and Terminal Kit



Part Number	Description	Std. Pkg. Qty.*
KP-506A	Contains natural nylon ties for indoor use: (100) PLT1M-C Cable Ties (100) PLT1.5I-C Cable Ties (100) PLT2S-C Cable Ties (50) ABM2S-A Mounts (1) Plastic Kit Box	1
KP-506A-0	Contains weather resistant cable ties and mounts for outdoor use: (100) PLT1M-C0 Black Weather Resistant Cable Ties (100) PLT1.5I-C0 Black Weather Resistant Cable Ties (100) PLT2S-C0 Black Weather Resistant Cable Ties (50) ABM2S-AT-0 Black Weather Resistant Mounts (1) Plastic Kit Box	1
KP-509	A special collection of cable ties and wiring accessories for prototyping and new product development. Contains (over 600 pieces): Including PAN-TY® Cable Ties (in different styles, sizes, colors and materials); 25 different cable tie mounts; 30 different wiring accessories; (1) Plastic Kit Box	1
KB-550	Assortment Pack contains natural and weather resistant PAN-TY® nylon cable ties: (15) PLT1M Cable Ties (10) PLT1M Black Weather Resistant Cable Ties (15) PLT1.5I Cable Ties (10) PLT1.5I Black Weather Resistant Cable Ties (15) PLT2S Cable Ties (10) PLT2S Black Weather Resistant Cable Ties (15) PLT3S Cable Ties (10) PLT3S Black Weather Resistant Cable Ties	1
KB-551	Assortment Pack contains natural and weather resistant DOME-TOP® Barb Ty nylon cable ties: (15) BT1M Cable Ties (10) BT1M Black Weather Resistant Cable Ties (15) BT1.5I Cable Ties (10) BT1.5I Black Weather Resistant Cable Ties (15) BT2S Cable Ties (10) BT2S Black Weather Resistant Cable Ties (15) BT3S Cable Ties (10) BT3S Black Weather Resistant Cable Ties	1
K-504	Contains cable ties, adhesive backed mounts and cable tie installation tool: (100) PLT1M-C Cable Ties (100) PLT1.5I-C Cable Ties (100) PLT2S-C Cable Ties (100) PLC2S-S10-C Clamp Ties (100) TM2S8-C Mounts (100) ABM2S-A-C Mounts (1) STS2 Tool (1) Steel Kit Box	1
SR2	2-Drawer Slide Rack to hold K-504 Kit or K-1100 Series Terminal Kits. See PANDUIT® Terminal Catalog, SA101N21B-NL.	1
K-205	Contains 300 cable ties, 600 terminals and 2 installation tools: (100) PLT1M-C Cable Ties (100) PLT1.5I-C Cable Ties (100) PLT2S-C Cable Ties (1) GTS Cable Tie Installation Tool (100) PV18-6LF-C Terminals (100) PV14-8LF-C Terminals (100) PV14-10LF-C Terminals (50) PV10-10LF-L Terminals (100) BSV18X-C Splices (100) BSV14X-C Splices (50) BSV10X-L Splices (1) CT-100 Crimping Tool (1) Steel Kit Box	1

## Cable Tie Installation Tools

The **PANDUIT®** Selection. . . **PANDUIT®** offers the greatest selection of job-matched tools:



Tool Controlled Tension and Cutoff Tools



Pneumatic Tool Controlled Tension and Cutoff Tools



Operator Controlled Tension and Cutoff Tools



PAT1M/PAT1.5M Automatic Cable Tie Installation Systems

### Choosing the right tool increases productivity. . .

Whatever the need; Original Equipment Manufacturer (high, medium, low volume), maintenance/repair or construction; **PANDUIT®** has the tool to help lower your total installed cost. The following chart can be used as a guide for tool selection:

Tool	Cable Tie Cross Section	Cable Tie Usage		Operation	Typical Application(s)
		Per Minute	Per Year		
GTS	SM, M, I or S	4-6	Under 50,000	Hand	Low to Medium Volume OEM tie usage, maintenance/repair or construction
GS2B	M, I, or S				
GTH	S, HS, LH or H				
GS4H	or H				
GS4H/B	S, HS, LH or H				
GS4H121W	S, HS, LH or H				
GS4EH	LH, H or EH	1-4	Under 10,000	Hand	Maintenance/repair or construction
STS2	M, I or S				
STH2	S, LH or H				
ST2EH	LH, H or EH				
STHV	LH or H	5-8	Up To 250,000	Pneumatic	Medium to High Volume OEM tie usage where a variety of tie sizes are needed.
PTS	SM, M, I or S				
PPTS	M, I, or S				
PPTEH	LH, H or EH	30-40	250,000 and above	Pneumatic/ Electric	High Volume OEM tie usage
PAT1M/PAT1.5M Systems (Automatic)	M				

## Hand-Operated Tools — Tool-Controlled Tension and Cut-Off



The most preferred hand-operated cable tie tools in the industry. These tools are versatile and can be used for production, maintenance or construction applications. These tools will tension and cut off excess tie material flush to the head by squeezing trigger handle.

### For PANDUIT® Cable Ties up to 1/2" (12.7mm) wide

- Lightweight and balanced
- Requires no special maintenance
- Easy to change tension adjustment and easy to operate
- Proven features to help lower installed costs; a combination of design, operating and construction features provide a long service life
- Replacement blades available

	Part Number	Description	Std. Pkg. Qty.*
	GTS	Installs PANDUIT® Subminiature, Miniature, Intermediate and Standard cross section cable ties. Qualified Product Listed per Mil. Std. MS90387-1 and Mil. Spec. MIL-T-81306A. Plastic molded housing. Ergonomic design.  Color Identification: Trigger Handle: Black Selector Knob: Black Weight: 8.8 oz. (249g)	1
	GS2B	Installs PANDUIT® Miniature, Intermediate and Standard cross section cable ties. Qualified Product Listed per Mil. Std. MS90387-1 and Mil. Spec. MIL-T-81306A.  Color Identification: Trigger Handle: Black Selector Knob: Black Weight: 11.5 oz. (327g)	1
	GTH	Installs PANDUIT® Standard, Heavy-Standard, Light-Heavy and Heavy cross section cable ties. Plastic molded housing. Ergonomic design.  Color Identification: Trigger Handle: Red Selector Knob: Red Weight: 11.2 oz. (318g)	1
	GS4H	Installs PANDUIT® Standard, Heavy-Standard, Light-Heavy and Heavy cross section cable ties. Durable powder coat finish. Qualified Product Listed per Mil. Std. MS90387-2 and Mil. Spec. MIL-T-81306A.  Color Identification: Trigger Handle: Red Selector Knob: Red Weight: 16 oz. (454g)	1
	GS4H/B	Installs PANDUIT® Standard, Heavy-Standard, Light-Heavy and Heavy cross section cable ties. Durable powder coat finish. High tension, factory set, non-adjustable.  Color Identification: Trigger Handle: Blue Weight: 16 oz. (454g)	1
	GS4H121W	Installs PANDUIT® Standard, Heavy-Standard, Light-Heavy and Heavy cross section cable ties. This tool provides greater tension, especially on 175 lb. strength ties, which results in tighter bundles. Durable powder coat finish.  Color Identification: Trigger Handle: Green Selector Knob: Green Weight: 16 oz. (454g)	1
	GS4EH	Installs PANDUIT® Light-Heavy, Heavy and Extra-Heavy cross section cable ties. Durable powder coat finish.  Color Identification: Trigger Handle: Blue Selector Knob: Blue Weight: 15 oz. (426g)	1







\*Order the number of pieces required in multiples of package quantities.

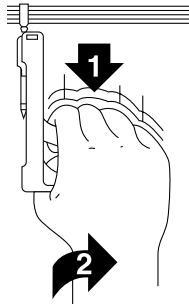

# PANDUIT® Hand-Operated Tools

## Hand Operated Tools— Installer-Controlled Tension and Cut-Off

PANDUIT® offers an economical series of tools for maintenance or construction applications — the user determines the required cable tie tension and the tools provide a cut-off. Used with the full line of PANDUIT® Cable Ties.

Part Number	Description	Std. Pkg. Qty.*
	<p>Installs PANDUIT® Miniature, Intermediate or Standard cross section cable ties. See STH2 operation below.</p> <p>Color Identification: Black Weight: 2 1/2 oz. (71g)</p>	1
 <ul style="list-style-type: none"> <li>• Inexpensive, maintenance-free, all purpose tools</li> <li>• Ergonomic handle design and short handle span</li> <li>• Top loading feature for right or left-handed users</li> </ul>	<p>Installs PANDUIT® Standard, Heavy-Standard, Light-Heavy or Heavy cross section cable ties.</p> <p>Color Identification: Red Weight: 2 1/2 oz. (71g)</p> <p>INSTALLATION PROCEDURE FOR STS2 AND STH2 TOOLS</p> <ol style="list-style-type: none"> <li>1. Install cable tie around bundle. Tension tie by squeezing tool handle.</li> <li>2. Reduce tension slightly and twist tool 1/4 turn either direction for cut-off of cable tie.</li> </ol> 	1
 <ul style="list-style-type: none"> <li>• Durable all steel construction</li> <li>• Comfortable rubber handles</li> </ul>	<p>Installs PANDUIT® Light-Heavy, Heavy or Extra-Heavy cross section cable ties.</p> <p>Color Identification: Black Handles Weight: 16 oz. (454g)</p> <p>After installing tie around bundle and tensioning, tool is twisted a 1/4 turn “in either direction” to cut off excess tie.</p> 	1
 <ul style="list-style-type: none"> <li>• Durable all steel construction</li> <li>• “Travel stop” helps prevent pinched fingers</li> </ul>	<p>Installs PANDUIT® Light-Heavy and Heavy cross section cable ties.</p> <p>Color Identification: All Yellow Weight: 14 oz. (399g)</p> <p>After installing tie around bundle, the handles are squeezed to provide tension. A separate lever cuts excess tie.</p> 	1

\*Order the number of pieces required in multiples of packaging quantities.

## Pneumatic Hand Tools Tool-Controlled Tension and Cut-Off

PANDUIT® pneumatic tools tension and cut off excess tie after it is hand-installed around the bundle, minimizing operator fatigue. Tools are rugged, yet lightweight.

### For PANDUIT® Cable Ties up to 1/2" (12.7mm) wide

- Easy to change tension adjustment
- Requires no special training to use
- Durable, lightweight, easy to operate and designed to reduce operator fatigue
- Tensions and cuts off excess tie in a fraction of a second
- Operates on non-lubricated air, without special maintenance



## Filter Regulator and Hose



Part Number	Description	Std. Pkg. Qty.*
PTS	Installs Subminiature, Miniature, Intermediate or Standard cross section cable ties.  Color identification: (Knob) Black Weight: 17.3 oz. (490g) Replacement parts can be part of a scheduled maintenance program Plastic molded housing Ergonomic design	1
PPTS	Installs Miniature, Intermediate or Standard cross section cable ties.  Color identification: (Knob) Black Weight: 18 oz. (510g) Replacement parts can be part of a scheduled maintenance program Powder coat finish	1
PPTEH	Installs Light-Heavy, Heavy and Extra-Heavy cross section cable ties.  Color Identification: (Knob) Blue Weight: 52 oz. (1476g) Replacement parts can be part of a scheduled maintenance program Powder coat finish	1
PPH10	10' (3m) Hose Assembly (regulator to tool). Includes a 1/8" NPT male connector (to regulator) and 1/8" female quick disconnect fitting (to tool).	1
PL289N1	Filter/Regulator .5 micron (max.) element, regulated range 3-100 PSIG, 1/8" ports.	1

Note: PTS, PPTS and PPTEH tools require the PPH10 hose and PL289N1 Filter/Regulator for proper operation.

## Adjustment Features

Each cross section of cable ties can be installed with a variety of tensions to meet the application. The proper tension range is marked on each package of cable ties.

### Fast and Easy Selection



GTS Tool — *Tension Setting Dial*



GS2B Tool — *Tension Setting Knob*

### Tool Tension Lock Kits

Certain applications require a locking device on the selector knob (one cross-section size and tension only).

Part Number	Description	Std. Pkg. Qty.*
<b>KGSTSL</b>	Tension Locking Kit for GTS.	10
<b>KGHTL</b>	Tension Locking Kit for GTH.	
<b>KPTSL</b>	Tension Locking Kit for PTS.	
<b>TTLK3</b>	Tool Tension Lock Kit. Each kit contains (1) #4-40 selection locking screw (with head), (1) selection locking clip, and (1) #4-40 tension locking screw (headless). For use with GS-Family Tools.	
<b>Blade Replacement Kits</b>		
<b>KGTSBLD</b>	Blade Replacement Kit for GTS, PTS.	1
<b>KGTHBLD</b>	Blade Replacement Kit for GTH.	
<b>K2-BLD2</b>	Blade Replacement Kit for GS2B and PPTS (all versions).	
<b>K4H-BLD</b>	Blade Replacement Kit for GS4H series (3-screw blade guard only).	
<b>KPTEHB</b>	Blade Replacement Kit for PTEH series.	
<b>Gripper Replacement Kits</b>		
<b>KPTEHG</b>	Gripper Replacement Kit for PTEH series.	1
<b>KPTSG</b>	Gripper Replacement Kit for PPTS.	
<b>KST2EHG</b>	Gripper Replacement Kit for ST2EH.	
<b>GHH</b>	Specifically designed to hold GTS, and GS (series) or PPTS tools. Used wherever the hand tools are used—construction sites to assembly lines for a convenient and handy place for the tool.	1

### Repair Parts

Can be part of a scheduled maintenance plan or use only when cutoffs are not clean and crisp.

### Hand Tool Accessory



GHH — Holster

\*Order the number of pieces required in multiples of package quantities.

# PANDUIT® Fully Automatic Cable Tie Installation Systems

## PAT1M/PAT1.5M Reel-Fed Systems for Miniature Cross Section Cable Ties (18 lb. (80N) minimum loop tensile)



- The system consists of the tool head, dispenser, feeder hose and continuously molded, reel-fed cable ties (5000 ties per reel). Each system will install a cable tie in less than one second
- Choice of two tool head sizes for bundle diameters up to .82" (21mm) or up to 1.3" (33mm)
- The dispenser and hose are designed to operate with either tool head for maximum versatility and economy
- The system design permits complete mobility in the use of the tool and location of the dispenser
- The system operates on 65 psig (minimum) non-lubricated, filtered air and 100-240 VAC 150 or 60 Hz—Automatically adjusts within this range
- Optional bench mount shown on page 61
- Choice of 3 materials

### Tool Heads



Part Number	Description	Std. Pkg. Qty.*
PAT1M	Tool Head for cable ties up to .82" (21mm) bundle diameter (PLT1M-XMR).	1
PAT1.5M	Tool Head for cable ties up to 1.3" (33mm) bundle diameter (PLT1.5M-XMR).	1

- Lightweight, no counter-balance required
- Slim, ergonomically designed handle for operator comfort and greater productivity. Reduces potential for repetitive motion injuries
- Right or left hand operation
- Durable, one-piece cable tie tip collector (for cut-off tips)
- Includes tension adjustment
- Built-in safety interlock prevents false triggering if anything obstructs jaw path

### Dispenser



PDM	Stationary dispenser for 100 VAC, 120 VAC and 230 VAC.	1				
<ul style="list-style-type: none"> <li>• LCD display monitors performance. If an error occurs an alarm is sounded</li> <li>• On-line HELP menu</li> <li>• Multi-language capability via LCD display (English, Spanish, German, Italian or French)</li> <li>• Cable tie reels are easily loaded into the dispenser, reducing downtime</li> <li>• Audible reload signal when reel is empty</li> <li>• Minimum maintenance required</li> <li>• Power cord included</li> </ul>		<table border="1"> <thead> <tr> <th colspan="2">Specifications</th> </tr> </thead> <tbody> <tr> <td> <b>Pneumatic</b> <ul style="list-style-type: none"> <li>• Operates at 65 psig minimum</li> <li>• 7 scfm flow minimum</li> <li>• Operates on non-lubricated air</li> </ul> </td> <td> <b>Electrical</b> <ul style="list-style-type: none"> <li>• 100-240 VAC</li> <li>• 50 or 60 Hz.</li> <li>• Less than 1 amp</li> <li>• Approx. 20 watts (AVG)</li> </ul> </td> </tr> </tbody> </table>	Specifications		<b>Pneumatic</b> <ul style="list-style-type: none"> <li>• Operates at 65 psig minimum</li> <li>• 7 scfm flow minimum</li> <li>• Operates on non-lubricated air</li> </ul>	<b>Electrical</b> <ul style="list-style-type: none"> <li>• 100-240 VAC</li> <li>• 50 or 60 Hz.</li> <li>• Less than 1 amp</li> <li>• Approx. 20 watts (AVG)</li> </ul>
Specifications						
<b>Pneumatic</b> <ul style="list-style-type: none"> <li>• Operates at 65 psig minimum</li> <li>• 7 scfm flow minimum</li> <li>• Operates on non-lubricated air</li> </ul>	<b>Electrical</b> <ul style="list-style-type: none"> <li>• 100-240 VAC</li> <li>• 50 or 60 Hz.</li> <li>• Less than 1 amp</li> <li>• Approx. 20 watts (AVG)</li> </ul>					

### Feeder Hose



#### Choose one:

PHM1	3.2' (1m) Feeder Hose.	1
PHM2	6.5' (2m) Feeder Hose.	1
PHM3	9.8' (3m) Feeder Hose.	1

- Transfers cable ties and signal from dispenser to tool head
- Available in three lengths for either tool head
- Reversible
- Large electrical connectors for quick, easy and secure connections

### Other Components



PDH10-37	Air hose from filter/regulator to dispenser/. 9.8' (3m). Includes standard air fittings.	1
PL283N1	Filter/regulator 25 micron (max.) element, 3/8" ports.	1

**PATMBM Bench Mount used with PAT1M/PAT1.5M Automatic Systems for Miniature Cross Section Cable Ties (18 lb., 80N minimum loop tensile)**



**For Operations Where the Application is Brought to the Tool**

- Used with either PAT1M or PAT1.5M tool head
- Supplied with a foot-actuated pedal to allow operator to work with both hands
- A tool can be installed in the mount in seconds
- Supplied with a four-hole base plate
- The bench mount operates on 65 psi non-lubricated, filtered air which pilots off of the dispenser

In addition to tool head, dispenser, feeder hose and cable ties on reels; order the following:

Part Number	Description	Pkg. Qty.
PATMBM	Bench mount and foot pedal for PAT1M/PAT1.5M system, four-hole base plate.	1

**Cable Ties for PAT1M/PAT1.5M Systems**

Continuously molded cable ties in sizes, color and material options to meet the application.



**Cable Ties on Reels**



- Miniature cross section cable ties
- Self-locking
- UL Recognized
- 5000 ties/reel

Part Number	Color	Max. Bundle Diameter in. (mm)	Length in. (mm)	Width in. (mm)	Min. Loop Tensile Strength Lbs. (N)	Use with PANDUIT® Installation System
<b>Nylon 6.6 (for indoor use) up to 185°F (85°C)</b>						
PLT1M-XMR	Natural	.82 (21)	4.0 (102)	.100 (2.5)	18 (80)	PAT1M
PLT1M-XMR1	Brown					
PLT1M-XMR2	Red					
PLT1M-XMR3	Orange					
PLT1M-XMR4	Yellow					
PLT1M-XMR5	Green					
PLT1M-XMR6	Blue					
PLT1M-XMR7	Purple					
PLT1M-XMR8	Gray					
PLT1M-XMR10	White					
PLT1.5M-XMR	Natural	1.31 (33)	5.6 (142)			PAT1.5M
<b>Weather Resistant Nylon (for outdoor use) up to 185°F (85°C)</b>						
PLT1M-XMR0	Black	.82 (21)	4.0 (102)	.100 (2.5)	18 (80)	PAT1M
PLT1.5M-XMR0		1.31 (33)	5.6 (142)			PAT1.5M
<b>Heat Stabilized Nylon (for indoor use) up to 238°F (115°C)</b>						
PLT1M-XMR30	Black	.82 (21)	4.0 (102)	.100 (2.5)	18 (80)	PAT1M
PLT1.5M-XMR30		1.31 (33)	5.6 (142)			PAT1.5M

Flammability Rating: UL 94V-2, ATB < sec. per ASTM-D635.

## Selecting the Proper Cable Tie Material for Your Application



By using this information as a guide, the user will be better equipped to select the best suited cable tie and material to perform its intended function over a long period of time.

For long life and dependable service, there are many factors to consider when selecting the proper cable tie for each application. Since it is impossible for *PANDUIT*® to provide data on all the various combinations of conditions which may arise, it is suggested that this data be used as a guide. Sample cable ties should be tested under actual end-use conditions to determine the correct cable tie for the application.

To select the optimum cable tie for a specific application, the following table can be used as a quick reference. First, determine the most critical design criteria and then read across the table to find which material is most suitable to meet this need (10 = Most Suitable and 1 = Least Suitable). Next, review the other criteria by scanning in a vertical direction on the chart and then make your final selection.

Design Criteria	Natural 6.6 Nylon	Weather Resistant 6.6 Nylon	Heat Stabilized Black 6.6 Nylon	Heat Stabilized Natural 6.6 Nylon	Heat Stabilized Weather Resistant 6.6 Nylon	Flame Retardant Black 6.6 Nylon	Flame Retardant 6.6 Nylon	Weather Resistant Nylon 12	Natural Polypropylene	Weather Resistant Polypropylene	TEFZEL ***	HALAR**	Weather Resistant Acetal	Stainless Steel*
Part Number Suffix Material Designation		-0	-30	-39	-300	-60	-69	-120	-109	-100	-76	-702	N/A	
Loop Tensile Strength	7	7	7	7	7	7	7	6	5	5	7	5	9	10
Low Temperature Service	6	6	6	6	6	5	5	6	6	6	7	7	6	10
High Temperature Service	5	5	6	6	6	5	5]	5	5	5	8	7	3	10
Flammability	6	6	6	6	6	8	8	3	2	2	9	9	2	10
Ultraviolet Resistance	1	6	4	1	6	1	1	7	1	6	9	9	9	10
Radiation Resistance	3	3	3	3	3	3	3	4	5	5	9	9	3	10
Overall Chemical Resistance	6	6	6	6	6	6	6	8	8	8	10	10	5	9
-Hydrocarbons	9	9	9	9	9	9	9	9	6	6	10	10	9	10
-Chlorinated Hydrocarbons	7	7	7	7	7	7	7	8	5	5	10	10	8	10
-Acids	2	2	2	2	2	2	2	6	9	9	10	10	2	10
-Bases	7	7	7	7	7	7	7	7	9	9	10	10	2	8
-Salts	3	3	3	3	3	3	3	8	10	10	10	10	4	9
Relative Price	Low	Low	Low	Low	Med.	Med.	Med.	Med.	Low	Low	High	High	Med.	High

### Example No. 1:

Application	Selection
If the application requires high radiation ( $2 \times 10^6$ rads) resistance, excellent resistance to hydrocarbons and the price is not critical.	The best choice is TEFZEL*** or stainless steel. The price is higher than other materials, but both have high ratings in resistance to radiation and hydrocarbons.

### Example No. 2:

Application	Selection
If the application requires a low cost material, good ultraviolet resistance and good resistance to acid rains.	The best choice is weather resistant polypropylene. Cost is low; it has a rating of 6 in ultraviolet resistance and a rating of 9 in resistance to acids.

# PANDUIT® Material Selection Guide

To select the proper cable tie for your application, start at the left of the chart and answer the “Yes” and “No” questions until you arrive at the correct material to use.

## Suggested Material to use

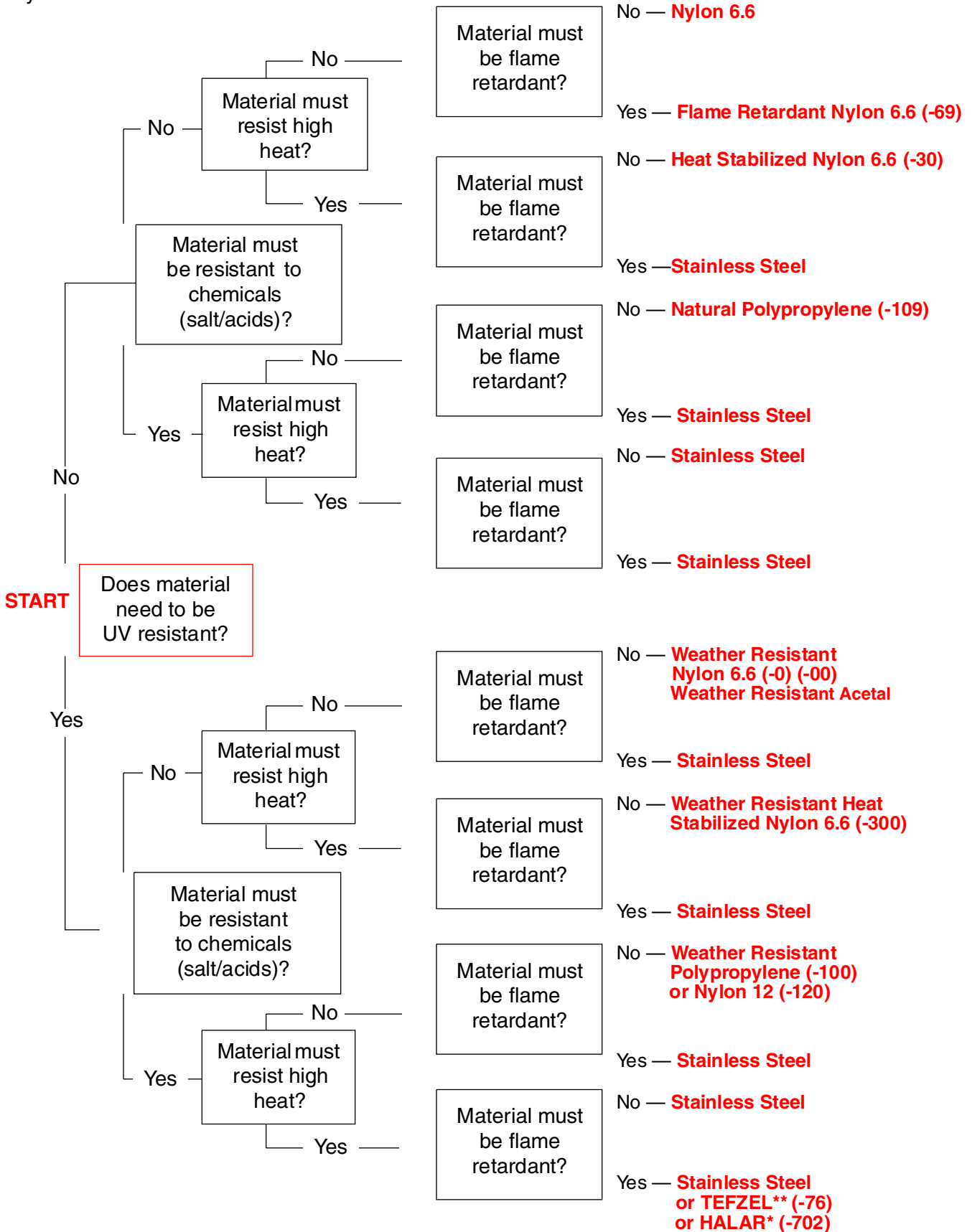

\*\*HALAR is a registered trademark of Solvay Solexis, Inc.  
 \*\*\* TEFZEL is a registered trademark of E. I. DuPont de Nemours Co.

## Weathering

Ultraviolet light (which is a component of sunlight) attacks, over a period of time, most plastic materials and reduces their properties by breaking the molecular chain. The material breakdown is accompanied by reductions in tensile strength and elongation, increased brittleness, color changes and loss of surface gloss.

Carbon black, which is used in *PANDUIT*® nylon and polypropylene cable ties, is one of the most effective stabilizers known today. A uniform dispersion of carbon black provides good ultraviolet light resistance without adversely affecting physical properties. The addition of carbon black, or any other ultraviolet light stabilizer, prolongs the useful life of plastic products used outdoors, but it does not totally eliminate the destructive effects of the light. Some plastics, such as TEFZEL\*\* or HALAR\*, are intrinsically very resistant to ultraviolet light and do not require stabilizing additives.



## Weathering Test Methods

In order to monitor the effects of ultraviolet light and the effectiveness of ultraviolet stabilizers, *PANDUIT*®, in conformance with industry standards, adopted two methods of weatherability testing: Outdoor Aging and Accelerated Weather Aging.

### Outdoor Aging

The Outdoor Aging method is probably the best and most realistic method of the two. It is conducted in accordance with ASTM D1435 Standard Practice for Outdoor Weathering of Plastics, and allows the material to be affected by not only ultraviolet light, but by all other outdoor elements as well. Although this may more closely approximate an actual application, two drawbacks do exist. The period of time required to produce property decay and material failure may be quite long, and varying adverse chemical environments cannot be tested.

### Accelerated Weather Aging

Accelerated weathering tests are conducted to estimate the rate of degradation due to a combination of ultraviolet light, temperature and moisture. The methods used are in accordance with the following standards:

- ASTM D1499, Operating Light and Water Exposure Apparatus (Carbon-Arc type) for exposure to plastics
- ASTM G53, Operating Light and Water Exposure (Fluorescent U.V. Condensation type) for exposure of non-metallic materials

The condition specified in ASTM D1499 utilizes a carbon arc to simulate natural sunshine and a water spray. The test chamber is operated 20 hrs/day with a two hour cycle of 108 minutes of simulated sunshine and 12 minutes of sunshine and water spray. The temperature of a black body inside the chamber is approximately 63°C (145°F) during the “Sunshine Only” portion of the cycle. Humidity is not controlled inside the chamber.

The test chamber per ASTM G53 uses fluorescent sun lamps to generate ultraviolet light only. A heated water pan produces condensation during a portion of the cycle. The daily cycle is composed of 20 hours of light followed by 4 hours of condensation. Black body temperatures during the light cycle are 50°C (122°F) and 40°C (104°F) during the condensation cycle.

*PANDUIT*® has also designed a special chamber which is used to simulate the effect of acid rain and ultraviolet light on cable tie materials. The effect of other common chemicals, such as road salt, are also evaluated in this chamber.

These methods are effective in quickly determining the ultraviolet light resistance of the various cable tie materials, but it must be emphasized that there are no exact correlations between accelerated aging and actual outdoor exposure.



**Material Failure Testing**

Property decay can lead to three different modes of failure: loss of strength, loss of toughness or change in appearance. The critical mode for any given application would depend upon the application and the requirements it places upon the material itself.

Loss of strength is monitored by tensile testing samples of the material before and after it has been weathered. This test will reveal the decreasing strength accompanied by extended weathering.

Loss of toughness can be monitored by measuring changes in elongation and impact strength. As ultraviolet light exposure time increases and the material becomes brittle, its elongation and impact strength are greatly reduced. It is important to note that brittle failures can occur even when the tensile strength shows no change.

Although change in appearance is normally not a failure mode for cable ties, the plastic does tend to discolor and lose its surface gloss as exposure increases. These changes can be measured by color difference using Adams units which are similar to National Bureau of Standard units.

*PANDUIT®* has its own weathering test program to determine estimated life of various cable tie materials. This includes examining many previously aged samples obtained throughout the world.

In all cases, the amount of property decay increased with increasing exposure to ultraviolet light. The principal signs of degradation were found to be brittleness, cracking and loss of surface gloss. It was also determined that the time for failure to occur was shorter than indicated from industry tests performed on material samples. This discrepancy is in part due to the fact that cable ties were tested in an end use, stressed condition, while most plastic resin suppliers conduct weathering tests using unstressed test bars.

Four cable tie materials (TEFZEL\*\*, HALAR\*, Weather Resistant ACETAL and Stainless Steel) have superior ultraviolet light resistance. In tests conducted to date, all have shown no significant signs of degradation.

Determining the outdoor life expectancy of any material is difficult since there are other factors, besides ultraviolet light stability, which have to be considered. These factors are listed below and should be considered before specifying a cable tie material.

**TABLE A — External Factors Which Affect the Life of a Cable Tie**

FACTORS	DECREASED LIFE
Chemicals	Applications which have chemicals present can reduce the life. <b>This is the most detrimental factor to the life of a tie.</b>
Bundle Diameter	As the bundle diameter is reduced, the tie has more bending stress. A thick strap on small diameter has more stress.
Loading	If the tie is under high loading, this will add additional stress on the tie body.
Thickness	A thinner tie will have a decreased life since surface cracks will penetrate the thickness of the tie faster.
Vibration	Applications with high vibrations will cause impact which will propagate any surface cracks.
Degree of Exposure	No shield or shade, southern exposure, higher altitudes and high temperatures decrease the life of the cable tie.
Moisture	Dry environments cause nylon 6.6 ties to become more brittle. High humidity plus high temperatures can result in degradation due to hydrolysis in nylon.
Galvanized Metals	Acid rain and acid moisture acting on galvanized metals release chemicals known to attack nylon 6.6.

WEATHERING LIFE EXPECTANCY	
Materials (P/N Suffix)	Years*
Natural Polypropylene (-109)	1
Natural Nylon 6.6	1-2
Flame Retardant Black Nylon 6.6 (-60)	1-2
Flame Retardant Nylon 6.6 (-69)	1-2
Heat Stabilized Nylon 6.6 (-30)	4-5
Heat Stabilized Natural Nylon 6.6 (-39)	1-2
Weather Resistant Nylon 6.6 (-0 & -00)	7-9
Heat Stabilized Weather Resistant Nylon 6.6 (-300)	7-9
Weather Resistant Polypropylene (-100)	7-9
Weather Resistant Nylon 12 (-120)	12-15
TEFZEL** (-76)	>15
HALAR* (-702)	>15
Acetal	>20
Stainless Steel (MLT prefix)	>30

\*Based on assumption of minimum loading, no chemical attack and impact-free conditions.

\*HALAR is a registered trademark of Solvay Solexis, Inc.  
 \*\*TEFZEL is a registered trademark of E. I. DuPont de Nemours Co.

## Flammability

A number of test procedures have been developed which can be used for the evaluation and comparison of various materials to support combustion.

### UL94 Vertical Burning Test

Samples of a material, with dimensions 127mm by 12.7mm and the thickness of the intended end use product, are tested in an unaged “as manufactured” state and in an aged state (7 days at 158°F, 70°C). The test requires the placement of a precisely controlled flame under a vertically supported specimen for a 10 second period. The flame is removed and the duration of flaming is recorded. If the flame extinguishes, the specimen is immediately subjected to a second 10 second ignition period. Duration of flaming is again recorded. A piece of surgical cotton is placed under the specimen. If drips ignite the cotton, this fact is also recorded.



### Materials Classed 94V-0

Materials classed 94V-0 shall:

- Not have any specimens which burn with flaming combustion for more than 10 seconds after either application of the test flame
- Not have a total flaming combustion time exceeding 50 seconds for the 10 flame applications for each set of five specimens
- Not have any specimens which burn with flaming or glowing combustion up to the holding clamp
- Not have any specimens which drip flaming particles that ignite the dry absorbent surgical cotton located 12" (305mm) below the test specimen
- Not have any specimens with glowing combustion which persists for more than 30 seconds after the second removal of the test flame

### Materials Classed 94V-1

Materials classed 94V-1 shall:

- Not have any specimens which burn with flaming combustion for more than 30 seconds after either application of the test flame
- Not have a total flaming combustion time exceeding 250 seconds for the 10 flame applications for each set of five specimens
- Not have any specimens which burn with flaming or glowing combustion up to the holding clamp
- Not have any specimens which drip flaming particles that ignite the dry absorbent surgical cotton located 12" (305mm) below the test specimen
- Not have any specimens with glowing combustion which persists for more than 60 seconds after the second removal of the test flame

### Materials Classed 94V-2

- Not have any specimens which burn with flaming combustion for more than 30 seconds after either application of the test flame
- Not have a total flaming combustion time exceeding 250 seconds for the 10 flame applications for each set of five specimens
- Not have any specimens which burn with flaming or glowing combustion up to the holding clamp
- Be permitted to have specimens that drip flaming particles which burn only briefly, some of which ignite the dry absorbent surgical cotton placed 12" (305mm) below the test specimen
- Not have any specimens with glowing combustion which persists for more than 60 seconds after the second removal of the test flame

**ASTM D 635**

Samples of a material, with dimensions 125mm by 12.5mm and the thickness of the intended end use product, are tested in an unaged “as manufactured” state. A precisely controlled flame is applied to the specimen and a stopwatch is started. The flame is applied for 30 seconds. The stopwatch is stopped when burning or glowing combustion ceases or when the flame has proceeded to a mark 100mm from the free end. Ten specimens are tested.

- Burning Rate
- If two or more specimens have burned to the 100mm mark then Average Burning Rate (cm/min.) shall be reported as the average of the burning rates of all specimens which have burned to the 100mm mark
- Average Time of Burning and Average Extent of Burning
- Average time of burning and average extent of burning of the sample shall be reported if none of ten samples or no more than one of twenty specimens have burned to the 100mm mark
- Average Time of Burning (ATB):
- Average Extent of Burning (AEB):

$$ATB,s = \frac{\sum_0^{10} (t - 30s)}{\text{Number of Specimens}}$$

Rounded to the nearest 5 sec.

$$AEB,mm = \frac{\sum_0^{10} (100 - \text{unburned length})}{\text{Number of Specimens}}$$

Rounded to the nearest 5mm

**Flammability Ratings**

Materials	UL94	ASTM D635
Natural Nylon 6.6	94V-2 (1/16")	AEB = 20mm ATB = 5 seconds
Weather Resistant Nylon 6.6 (-00)	94V-2 (1/16")	AEB = 20mm ATB = 5 seconds
Weather Resistant Nylon 6.6 (-0)	94V-2 (1/16")	AEB = 20mm ATB = 5 seconds
Heat Stabilized Nylon 6.6 (-30)	94V-2 (1/16")	AEB = 20mm ATB = 5 seconds
Heat Stabilized Natural Nylon 6.6 (-39)	94V-2 (1/16")	AEB = 20mm ATB = 5 seconds
Heat Stabilized Weather Resistant Nylon 6.6 (-300)	94V-2 (1/16")	AEB = 20mm ATB = 5 seconds
Flame Retardant Black Nylon 6.6 (-60)	94V-0 (1/64")	AEB = 15mm ATB < 5 seconds
Flame Retardant Nylon 6.6 (-69)	94V-0 (1/64")	AEB = 15mm ATB < 5 seconds
Weather Resistant Nylon 12 (-120)	Not Recognized	Ave. Burning Rate 1.6cm/min.
Natural Polypropylene (-109)	Not Recognized	Ave. Burning Rate 2 cm/min.
Weather Resistant Polypropylene (-100)	94 HB (.94mm)	Ave. Burning Rate 2 cm/min.
TEFZEL** (-76)	94V-0(1/16")	AEB < 15mm ATB < 5 seconds
HALAR* (-702)	94V-0(1/16")	AEB = 15 min. ATB < 5 seconds*
Weather Resistant ACETAL (DT Series)	94 HB (1.5mm)	Ave. Burning Rate 2.8 cm/min.
Stainless (MLT prefix)	Not Applicable	Not Applicable

Rating based on 1/8" thick test samples

\*HALAR is a registered trademark of Solvay Solexis, Inc.  
\*\*TEFZEL is a registered trademark of E. I. DuPont de Nemours Co.

## Radiation

Installed cable ties of various materials have been exposed to different amounts of radiation to determine the maximum acceptable limit. These tests were conducted by PANDUIT® mainly to determine the acceptability for use in various areas of nuclear power plants (accumulated over 40 year life). See Table B (page 69) for radiation resistance rating.



## Moisture

Many plastics when exposed to high relative humidity absorb water and, as such, the tensile strength of the material can change dramatically. Nylon 6.6 when exposed to 100% relative humidity, will absorb as much as 8.5% water which will reduce tensile strength by 50% when compared to a dry cable tie. Polypropylene, HALAR\*, Type 12 Nylon, TEFZEL\*\* and ACETAL are low water absorbing materials and, as such, the effect of water is minimal. See Table B (page 69) for moisture absorption.



## Temperature

Plastic materials normally undergo property loss during exposure to high temperature due to oxidation. The Maximum Continuous Use Temperature for cable tie materials depends upon the time at the elevated temperature as well as other environmental conditions. Initially, plastics become more flexible and weaker when exposed to high temperatures. After a period of time, oxidation may occur which will cause embrittlement, making plastic cable ties more susceptible to failure from impact and vibration.

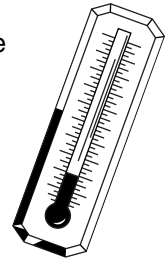

The Maximum Continuous Use Temperature, otherwise known as the Relative Thermal Index (mechanical without impact) is determined per UL746B. It is one indicator of a materials ability to retain a particular physical property when exposed to elevated temperatures over an extended period of time. It is based on the assumption that there is no loading, no chemical attack and impact free condition. The Maximum Continuous Use Temperatures for cable tie materials are listed in Table B (see page 69).

Low temperature exposure will also make most plastics more brittle during the exposure, but little property loss occurs when the material is returned to room temperatures. The Minimum Continuous Use Temperatures for cable tie materials are listed in Table B (see page 69).

## Tensile Strength

Most cable ties are selected based on material, length and minimum loop tensile strength. Minimum loop tensile strength was established under SAE Aerospace Standard AS23190. Each cross section cable tie (Miniature-M, Intermediate-I, Standard-S, Heavy-H and Extra Heavy-EH) has a different loop tensile strength when tested per AS23190.

The cable tie is first conditioned at 49°C (120°F), 20% relative humidity for 24 hours, then the cable tie is installed on a split mandrel and the halves of the mandrel separated at a rate of 1" (25.4mm) per minute (Fig.1). The separating force required to unlock or break the cable tie is the loop tensile strength. Loop tensile strength is dependent both on the locking design and the tensile strength (psi) of the material. As an example, the tensile strength of polypropylene material is approximately 1/2 to 1/3 of nylon 6.6; thus the loop tensile strength of a given cross section tie made of polypropylene would be much less than a tie made of nylon 6.6. This is another property to be considered when selecting a cable tie. The various representative loop tensile strengths are listed in Table B (page 69).

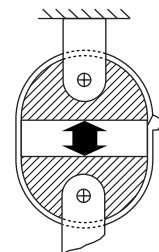

Fig. 1

**TABLE B**

Design Criteria	Natural 6.6 Nylon	Weather Resistant 6.6 Nylon	Heat Stabilized Black 6.6 Nylon	Heat Stabilized Natural 6.6 Nylon	Heat Stabilized Weather Resistant 6.6 Nylon	Flame Retardant Black 6.6 Nylon	Flame Retardant 6.6 Nylon	Weather Resistant Nylon 12	Natural Polypropylene	Weather Resistant Polypropylene	TEFZEL**	HALAR*	Weather Resistant Acetal	Stainless Steel
Part Number Suffix/ Material Designation	None	-0 and -00	-30	-39	-300	-60	-69	-120	-109	-100	-76	-702	N/A	N/A
Tensile Strength 73°F (psi)	12,000 (Note 1)	12,000 (Note 1)	12,000 (Note 1)	12,000 (Note 1)	12,000 (Note 1)	12,000 (Note 1)	12,000 (Note 1)	8,100 (Note 1)	4,100 (Note 1)	4,100 (Note 1)	7,500 (Note 1)	7,000 (Note 1)	6,500 (Note 2)	90,000 (Note 3)
Color	Natural	Black	Black	Natural	Black	Black	Ivory	Black	Green	Black	Aqua	Maroon	Black	Stainless
UL Flammability	See Page 66													
Oxygen Index	28	28	26	26	26	34	34	NA	NA	NA	30	60	NA	NA
Radiation Resistance	1 x 10 <sup>5</sup> Rads	1 x 10 <sup>5</sup> Rads	1 x 10 <sup>5</sup> Rads	1 x 10 <sup>5</sup> Rads	1 x 10 <sup>5</sup> Rads	1 x 10 <sup>5</sup> Rads	1 x 10 <sup>5</sup> Rads	3.5 x 10 <sup>5</sup> Rads	1 x 10 <sup>5</sup> Rads	1 x 10 <sup>5</sup> Rads	2 x 10 <sup>8</sup> Rads	2 x 10 <sup>8</sup> Rads	6 x 10 <sup>5</sup> Rads	2 x 10 <sup>8</sup> Rads
Water Absorption (24 hours)	1.2%	1.2%	1.2%	1.2%	1.2%	1.1%	1.1%	0.3%	0.1%	0.1%	<0.03%	<0.05%	<0.45%	None
Ultraviolet Light Resistance	Poor	Good	Fair	Poor	Good	Poor	Poor	Good	Poor	Good	Very Good	Very Good	Excellent	Excellent
Max. Continuous Use Temperature (Note 4)	185°F 85°C	185°F 85°C	239°F 115°C	239°F 115°C	212°F 100°C (Note 5)	212°F 100°C	212°F 100°C	194°F 90°C	238°F 115°C	238°F 115°C	338°F 170°C	302°F 150°C	185°F 85°C	1000°F 537°C (Note 6)
Min. Continuous Use Temperature (Note 7)	-40°F -40°C	-40°F -40°C	-40°F -40°C	-40°F -40°C	-40°F -40°C	-40°F -40°C	-40°F -40°C	-40°F -40°C	-40°F -40°C	-40°F -40°C	-50°F -46°C	-50°F -46°C	-40°F -40°C	-112°F -80°C
Minimum Loop Tensile Strength @ 120°F 20% RH	Submin.	12 lb.	12 lb.	N/A	N/A	N/A	N/A	N/A	N/A	N/A	N/A	N/A	N/A	N/A
	Min.	18 lb.	18 lb.	18 lb.	18 lb.	18 lb.	18 lb.	18 lb.	12 lb.	12 lb.	18 lb.	18 lb.	N/A	N/A
	Int.	40 lb.	40 lb.	40 lb.	40 lb.	30 lb.	30 lb.	40 lb.	25 lb.	N/A	25 lb.	N/A	N/A	N/A
	Std. Hvy.-Std. Hvy.	50 lb. 85 lb. 120/ 175 lb.	50 lb. 85 lb. 120/ 175 lb.	50 lb. N/A 120/ 175 lb.	50 lb. N/A 120/ 175 lb.	50 lb. N/A 120 lb.	50 lb. N/A 120 lb.	50 lb. N/A 120 lb.	40 lb. N/A 90 lb.	30 lb. N/A 50 lb.	30 lb. N/A 50 lb.	50 lb. N/A 120 lb.	50 lb. N/A N/A	N/A N/A N/A
EH DH	250 lb.	250 lb.	250 lb.	250 lb.	N/A	N/A	N/A	N/A	90 lb.	90 lb.	N/A	N/A	250 lb.	N/A 600 lb.
Tool Installed	GTS GTH GS4H GS4EH STS2 STH2 ST2EH ST2EH STHV PTS PPTS PPTS PPTEH	GTS GTH GS4H GS4EH STS2 STH2 ST2EH ST2EH STHV PTS PPTS PPTS PPTEH	GTS GTH GS4H GS4EH STS2 STH2 ST2EH ST2EH STHV PTS PPTS PPTEH	GTS GTH GS4H GS4EH STS2 STH2 ST2EH ST2EH STHV PTS PPTS PPTEH	GTS GTH GS4H GS4EH STS2 STH2 ST2EH ST2EH STHV PTS PPTS PPTEH	GTS GTH GS4H GS4EH STS2 STH2 ST2EH ST2EH STHV PTS PPTS PPTEH	GTS GTH GS4H GS4EH STS2 STH2 ST2EH ST2EH STHV PTS PPTS PPTEH	GTS GTH GS4H GS4EH STS2 STH2 ST2EH ST2EH STHV PTS PPTS	GTS GTH GS4H GS4EH STS2 STH2 ST2EH ST2EH STHV PTS PPTS	GTS GTH GS4H GS4EH STS2 STH2 ST2EH ST2EH STHV PTS PPTS	GTS GTH GS4H GS4EH STS2 STH2 ST2EH ST2EH STHV PTS PPTS	GTS GTH GS4H GS4EH STS2 STH2 ST2EH ST2EH STHV PTS PPTS	GTH GS4H GS4EH ST2EH	GS4MT ST2MT PPTMT HTMT

NOTE 1: ASTM D638  
 NOTE 2: Telcordia TR-TSY-000789  
 NOTE 3: ASTM E8  
 NOTE 4: See page 68 — Temperature  
 NOTE 5: Estimated  
 NOTE 6: (-321) goes to 1700° (923°C)  
 NOTE 7: After installation

\*HALAR is a registered trademark of Solvay Solexis, Inc.  
 \*\*TEFZEL is a registered trademark of E. I. DuPont de Nemours Co.

## TABLE C Chemical Resistance

Many factors combine to determine the useful life of a cable tie material and none is as important as chemical exposure. Various chemicals will have different effects on plastics depending on such things as chemical concentrations, temperature, stress and ultraviolet light. Table C is an excellent guideline for the selection of the best cable tie material. It should be noted that the exposure temperature for this chemical resistance chart is 70°F.



### Resistance of PANDUIT® Cable Tie Materials to Chemical Attack at 70°F

— = Not Tested  
E = Excellent  
S = Satisfactory  
B = Slight Attack  
U = Attacked

<sup>1</sup> (NOTE 1) = Pitting occurs under some conditions  
<sup>2</sup> (NOTE 2) = Attack may occur if sulfuric acid present  
Aq. = Aqueous  
C.S. = Cold Saturated

Agent	Percent Concentration	* Nylon 6.6	Nylon 12	Polypropylene	TEFZEL***	HALAR**	304 Stainless Steel	316 Stainless Steel
Acetaldehyde	90	S	—	B	E	E	—	—
Acetic Acid	97	U	U	E	E	E	E	E
Acentic Acid	10	B	S	E	E	E	E	E
Acetic Anyhdride	90	—	S	E	E	E	E	E
Acetone	100	E	E	E	E	E	E	E
Acetophenone	100	—	—	S	E	E	E	E
Acetylene	100	—	—	E	E	E	E	E
Aluminum Chloride	10	S	E	E	E	E	U	B
Aluminum Fluoride	10	S	E	E	E	E	U	B
Aluminum Hydroxide	Aq. C.S.	—	E	E	E	E	E	E
Aluminum Potassium Sulfate	10	S	E	E	E	E	E <sup>1</sup>	E
Ammonia	All	—	E	E	E	E	E	E
Ammonium Carbonate	1 to 5	—	E	—	E	E	E	E
Ammonium Chloride	10 to 25	U	E	E	E	E	E <sup>1</sup>	E
Ammonium Hydroxide	10	E	—	—	E	E	—	—
Ammonium Nitrate	100	—	E	E	E	E	E	E
Ammonium Sulfate	10	—	E	E	E	E	E <sup>1</sup>	E <sup>1</sup>
Amyl Acetate	100	—	—	B	E	E	E	E
Aniline	100	—	S	E	E	E	E	E
Antimony Trichloride	All	U	—	E	E	E	E	E
Arsenic Acid	1 to 80	—	—	E	E	E	E	E
Barium Carbonate	All	—	E	E	E	E	E	E
Barium Chloride	All	—	E	E	E	E	E <sup>1</sup>	E
Barium Sulfate	All	—	E	E	E	E	E	E
Barium Sulfide	All	—	E	E	E	E	E	E
Benzene	100	E	E	B	E	E	E	E
Benzoic Acid	100	U	E	E	E	E	E	E
Benzoyl Chloride	100	—	—	B	E	E	—	—
Benzyl Alcohol	100	—	—	E	E	E	—	—
Boric Acid	All	U	E	E	E	E	S	—
Bromine	100	U	U	U	E	E	U	U
Butadiene	100	—	—	B	E	E	E	E
Butane	100	—	E	E	E	E	E	E
Butanediol	100	—	—	E	E	E	—	—
Butyl Acetate	100	—	E	B	E	E	—	—
N. Butyl Alcohol	100	—	E	E	E	E	E	E
Butyl Phthalate	100	—	—	E	E	E	—	—
Butyraldehyde	100	—	—	E	E	E	—	—
Butyric Acid	10 to 100	U	—	E	E	E	E	E
Calcium Carbonate	Aq. C.S.	—	—	E	E	E	E	E
Calcium Chlorate	Aq. C.S.	—	—	E	E	E	E	E
Calcium Chloride	5	B	E	E	E	E	E <sup>1</sup>	E <sup>1</sup>

\*Includes all 6.6 Nylons (such as Weather Resistant, Heat Stabilized and Flame Retardant).

\*\*HALAR is a registered trademark of Solvay Solexis, Inc.

\*\*\*TEFZEL is a registered trademark of E. I. DuPont de Nemours Co.

**Table C — (cont.)**

**Resistance of PANDUIT® Cable Tie Materials to Chemical Attack at 70°F**

Agent	Percent Concentration	* Nylon 6.6	Nylon 12	Polypropylene	TEFZEL***	HALAR**	304 Stainless Steel	316 Stainless Steel
Calcium Hydroxide	50	—	—	E	E	E	E	E
Calcium Hypochlorite	2	U	—	E	E	E	E'	E'
Calcium Nitrate	50	—	E	E	E	E	—	—
Calcium Sulfate	2	B	—	E	E	E	E	E
Carbon Tetrachloride	100	E	E	U	E	E	E	E
Carbon Tetrachloride	Aq. 10	—	—	—	—	E	B'	E'
Chlorine	Dry	—	U	U	E	E	B	B
Chlorine	Wet	—	U	B	E	E	U	U
Chloroacetic Acid	10 to 50	U	—	E	E	E	U	B
Chlorobenzene	100	—	B	E	E	E	—	—
Chloroform	100	E	B	B	E	E	E	E
Chlorosulphonic Acid	10 to 100	U	U	U	S	E	U	U
Chromic Acid	10 to 50	U	U	E	E	E	B	B
Citric Acid	10 to 50	S	S	E	—	E	E	E
Copper Chloride	1 to 10	U	—	E	E	E	E' to U	E' to B'
Copper Cyanide	Aq. C.S.	—	—	E	E	E	E	E
Copper Nitrate	50	—	—	E	E	E	E	E
Cresol	100	U	U	—	E	E	E	E
Crotonaldehyde	100	—	—	E	E	E	—	—
Cyclohexane	100	—	E	B	E	E	E	—
Cyclohexanol	100	—	E	E	E	E	E	—
Cyclohexanone	100	—	E	B	E	E	E	—
Dibutyl Phthalate	100	—	—	E	E	E	—	—
Dichloroethane	100	—	—	E	—	E	E	E
Dichloroethylene	100	—	—	B	E	E	—	—
Diesel Fuel	100	—	E	B	E	E	E	E
Diethyl Ether	100	—	E	E	E	E	E	E
Diglycolic Acid	Aq.C.S.	—	—	E	E	E	—	—
Disobutyl Ketone	100	—	—	E	E	E	—	—
Dimethyl Amine	100	—	—	E	E	E	—	—
Dimethyl Formamide	100	—	E	E	E	E	E	—
Dimethyl Sulfate	100	—	—	B	E	E	—	—
Diocetyl Phthalate	100	—	—	E	E	E	E	—
1, 4-Dioxane	100	—	S	B	E	E	E	—
Ethyl Acetate	100	E	E	S	E	E	E	E
Ethyl Alcohol	100	E	E	E	E	E	E	E
Ethyl Chloride	100	—	—	B	E	E	E	E
Ethylene Chloride	100	E	B	B	E	E	E	E
Ethylene Glycol	100	E	E	E	E	E	E	E
Ethylene Oxide	100	—	—	B	E	E	—	—
Fatty Acids	100	—	—	E	E	E	—	—
Ferric Chloride	50	U	—	E	E	E	U	U
Ferric Hydroxide	All	—	—	E	E	E	E	E
Ferric Nitrate	All	—	—	E	E	E	E	E
Ferrous Chloride	Aq. C.S.	U	—	E	E	E	U	B
Ferrous Sulfate	10	—	—	E	E	E	E'	E
Fluorine (Dry)	100	—	—	U	E	—	U	U
Formaldehyde	40	E	S	E	E	E	E'	E
Formic Acid	All	U	U	E	E	E	E	E
Freons	100	E	—	—	E	E	—	—
Fuel Oil	100	—	E	—	E	E	E	E
Furfural	100	E	—	—	E	E	E	E
Gallic Acid	Aq. C.S.	—	—	—	E	E	E	E
Gasoline	100	E	—	B	E	E	E	E
Glycerin	100	—	E	E	—	E	E	E

\*Includes all 6.6 Nylons (such as Weather Resistant, Heat Stabilized and Flame Retardant).

\*\*HALAR is a registered trademark of Solvay Solexis, Inc.

\*\*\*TEFZEL is a registered trademark of E. I. DuPont de Nemours Co.

**Table C — (cont.)**

**Resistance of PANDUIT® Cable Tie Materials to Chemical Attack at 70°F**

Agent	Percent Concentration	* Nylon 6.6	Nylon 12	Polypropylene	TEFZEL***	HALAR**	304 Stainless Steel	316 Stainless Steel
Glycolic Acid <sup>b</sup>	40	U	—	E	E	E	—	—
Heptane	100	—	E	E	E	E	E	E
Hexane	100	—	E	E	E	E	E	E
Hydrobromic Acid	All	U	U	E	E	E	U	U
Hydrochloric Acid	All	U	U	E	E	E	U	U
Hydrocyanic Acid	All	—	U	E	E	E	B	B
Hydrofluoric Acid	All	U	U	E	E	E	U	U
Hydrofluorosilicic Acid	30	—	U	E	E	E	U	U
Hydrogen Peroxide	30	U	S	S	E	E	S	E
Hydrogen Sulfide	Dry	—	—	E	E	E	E	E
Hydrogen Sulfide	Wet	U	—	E	E	E	B <sup>2</sup>	E <sup>2</sup>
Hydroquinone	100	—	—	E	E	E	—	—
Iodine	100	—	—	E	E	E	U	U
Iodoform	100	—	—	—	E	E	E	E
Isopropyl Alcohol	100	E	E	E	E	E	E	E
Jet Fuel	100	E	—	E	E	E	E	E
Lactic Acid	10	E	S	E	E	E	E	E
Lanolin	10	E	E	E	E	E	E	E
Lead Acetate	Aq. C.S.	—	—	E	E	E	E	E
Linseed Oil	100	E	E	E	E	E	E	E
Magnesium Carbonate	Aq. C.S.	—	E	E	E	E	E	E
Magnesium Chloride	Aq. C.S.	B	E	E	E	E	E <sup>1</sup>	E <sup>1</sup>
Magnesium Nitrate	Aq. C.S.	—	E	E	E	E	E	E
Maleic Acid	100	—	—	E	E	E	—	—
Malic Acid	Aq. C.S.	—	—	E	E	E	E	E
Mercuric Chloride	Dilute	—	E	E	E	E	U	U
Mercury	100	—	E	E	E	E	E	E
Methyl Alcohol	100	E	E	E	E	E	E	E
Methyl Bromide	100	—	—	U	E	E	—	—
Methyl Chloride	100	—	—	B	E	E	—	E
Methyl Chloroform	100	E	—	B	E	E	—	—
Methyl Ethyl Ketone	100	—	E	B	E	E	E	E
Methyl Isobutyl Ketone	100	E	—	B	E	E	E	E
Methylene Chloride	100	B	U	B	E	E	E	E
Naptha	100	—	—	E	E	E	E	E
Naphthalene	100	—	S	E	E	E	E	E
Nickel Chloride	Aq. C.S.	—	E	E	E	E	E <sup>1</sup>	E <sup>1</sup>
Nickel Sulfate	Aq. C.S.	—	E	E	E	E	E <sup>1</sup>	E <sup>1</sup>
Nitric Acid	10 to 30	U	U	E	E	E	E	E
Nitric Acid	30 to 68	U	U	U	S	E	E	E
Nitro Benzene	100	—	B	B	E	E	E	E
Nitro Methane	100	E	—	—	E	E	—	—
Nitrous Acid	5	—	—	—	E	E	E	E
Oleic Acid	100	—	B	E	E	E	E	E
Oxalic Acid	10	—	B	E	E	E	E	E
Oxygen	All	—	—	E	E	E	—	—
Paraffin	100	E	E	E	E	E	E	E
Perchloroethylene	100	—	—	B	E	E	E	E
Petroleum Ether	100	—	E	E	E	E	E	E
Phenol	90	U	U	E	E	E	E	E
Phosphoric Acid	10	U	U	E	E	E	E	E
Phosphorus Pentoxide	100	—	U	E	E	E	—	—
Phosphorus Trichloride	100	—	U	B	E	E	E	E
Phthalic Acid	50	—	—	B	E	E	E	E
Pictic Acid	1	—	—	E	E	E	E	E

\*Includes all 6.6 Nylons (such as Weather Resistant, Heat Stabilized and Flame Retardant).

\*\*HALAR is a registered trademark of Solvay Solexis, Inc.

\*\*\*TEFZEL is a registered trademark of E. I. DuPont de Nemours Co.



**Table C — (cont.)**

**Resistance of PANDUIT® Cable Tie Materials to Chemical Attack at 70°F**

Agent	Percent Concentration	* Nylon 6.6	Nylon 12	Polypropylene	TEFZEL***	HALAR**	304 Stainless Steel	316 Stainless Steel
Potassium Borate	1	—	—	E	E	E	—	—
Potassium Bromide	Aq. C.S.	—	—	E	E	E	E <sup>1</sup>	E <sup>1</sup>
Potassium Carbonate	Aq. C.S.	—	B	E	E	E	E	E
Potassium Chlorate	Aq. C.S.	—	S	E	E	E	E	E
Potassium Chloride	5	—	E	E	E	E	E <sup>1</sup>	E <sup>1</sup>
Potassium Dichromate	Aq. C.S.	—	U	E	E	E	E	E
Potassium Ferrocyanide	25	—	—	E	E	E	E	E
Potassium Hydroxide	30	B	—	E	E	E	B	B
Potassium Iodide	Aq. C.S.	—	E	E	—	E	E	E
Potassium Nitrate	Aq. C.S.	—	E	E	E	E	E	E
Potassium Perchlorate	1	—	—	E	E	E	—	—
Potassium Permanganate	5	U	U	E	E	E	E	E
Potassium Persulfate	All	—	—	E	E	E	—	—
Potassium Sulfate	Aq. C.S.	—	E	E	E	E	E	E
Potassium Sulfide	Aq. C.S.	—	—	E	E	E	E	E
Propionic Acid	50	—	—	E	E	E	—	—
Propyl Alcohol	100	E	—	E	E	E	E	E
Pyridine	100	—	E	B	E	E	B	B
Sea Water	100	—	E	E	E	E	E <sup>1</sup>	E
Silver Chloride	Aq. C.S.	—	E	E	E	E	U	U
Silver Nitrate	10	—	E	E	E	E	E	E
Sodium Acetate	Aq. C.S.	E	—	E	E	E	E <sup>1</sup>	E
Sodium Benzoate	Aq. C.S.	—	—	E	E	E	—	—
Sodium Bicarbonate	Aq. C. S.	E	E	E	E	E	E	E
Sodium Bisulfate	10	—	—	E	E	E	E	E
Sodium Bisulfite	Aq. C.S.	—	S	E	E	E	E	E
Sodium Borate	Aq. C.S.	—	—	E	E	E	E	E
Sodium Carbonate	2	E	E	E	E	E	E	E
Sodium Chlorate	25	—	B	E	E	E	E	E
Sodium Chloride	10	E	E	E	E	E	E <sup>1</sup>	E <sup>1</sup>
Sodium Chromate	Aq. C.S.	U	—	E	E	E	E	E
Sodium Fluoride	5	—	—	E	E	E	E <sup>1</sup>	E <sup>1</sup>
Sodium Hydroxide	10	E	E	E	E	E	E	E
Sodium Hypochlorite	5	S	B	E	E	E	B <sup>1</sup>	E <sup>1</sup>
Sodium Hyposulfite	Aq. C.S.	—	—	—	E	E	E	E
Sodium Nitrate	5	E	E	E	E	E	E	E
Sodium Nitrite	Aq. C.S.	—	B	E	E	E	E	E
Sodium Perborate	Aq. C.S.	—	S	E	E	E	—	B
Sodium Perchlorate	10	—	—	—	E	E	E	E
Sodium Phosphate	5	—	E	E	E	E	E	E
Sodium Sulfate	5	—	E	E	E	E	E	E
Sodium Sulfide	5	—	E	E	E	E	E <sup>1</sup>	E
Sodium Thiosulfate	25	—	E	E	E	E	E <sup>2</sup>	E <sup>2</sup>
Stannic Chloride	Aq. C.S.	U	—	E	E	E	U	B
Stannous Chloride	Aq. C.S.	—	E	E	E	E	B	S
Stearic Acid	100	—	B	E	E	E	E	E
Succinic Acid	100	—	S	E	E	E	—	—
Sulfur	100	—	E	E	E	E	S	B
Sulfur Dioxide	All	U	—	B	E	E	E	E
Sulfuric Acid	5	U	B	E	E	E	B	E
Sulfuric Acid	50	U	U	E	E	E	U	B
Sulfuric Acid	Concentrate	U	U	B	E	E	B	B

\*Includes all 6.6 Nylons (such as Weather Resistant, Heat Stabilized and Flame Retardant).

\*\*HALAR is a registered trademark of Solvay Solplex, Inc.

\*\*\*TEFZEL is a registered trademark of E. I. DuPont de Nemours Co.

**Table C — (cont.)**

**Resistance of *PANDUIT®* Cable Tie Materials to Chemical Attack at 70°F**

Agent	Percent Concentration	* Nylon 6.6	Nylon 12	Polypropylene	TEFZEL ***	HALAR**	304 Stainless Steel	316 Stainless Steel
Sulfurous Acid	10	E	—	E	E	E	B <sup>1</sup>	E <sup>1</sup>
Tannic Acid	10	—	E	E	E	E	E	E
Tartaric Acid	50	—	S	E	E	E	E	E
Tetrahydrofuran	100	—	B	B	E	E	E	E
Toluene	100	E	E	B	E	E	E	E
Trichloroacetic Acid	10	U	—	S	E	E	U	U
Trichloroethylene	100	—	U	B	E	E	E <sup>1</sup>	E <sup>1</sup>
Turpentine	100	—	S	U	E	E	E	E
Urea	50	—	E	E	E	E	—	—
Vinyl Acetate	100	—	—	E	E	E	—	—
Xylene	100	E	—	U	E	E	E	E
Zinc Chloride	70	U	E	E	E	E	E	E
Zinc Nitrate	Aq. C.S.	—	E	E	E	E	E	E
Zinc Sulfate	Aq. C.S.	—	E	E	E	E	E	E



The owner-operator concept makes employees responsible for their areas of the manufacturing process.

*PANDUIT®* Total Quality Assurance (TQA) initiative spans more than two decades. During that time we have furnished quality training to all levels of our employees, enabling them to participate in our Excellence Through Quality (ETQ) program of continuous quality improvement.

Our quality policies and major improvement projects are chosen and monitored by the Corporate Process Improvement Committee. This group is comprised of the top management representatives from each of *PANDUIT®* business segments.



Operator inspection is an important *PANDUIT®* TQA procedure.

*PANDUIT®* Engineering and Manufacturing groups work together to design quality into the products and the production processes. Service quality is equally important and our customer service group takes the lead in assuring superior performance from the supporting departments.



Members of ETQ Teams search for ways to improve product quality.

Our high degree of product and service quality is due in part to heavy investment in technology by *PANDUIT®*. However, people are really the foundation for our quality achievements. We believe in Quality at the Source.

By introducing Quality at the Source throughout the company, we have provided the training, supplied the necessary equipment and moved the responsibility for performance to the employees doing the work. Their pride in product and service is demonstrated every day in how we serve our customers.

*PANDUIT®* ISO 9001 and QS-9000 registrations serve notice to our customers that we support their business through our reliable quality systems. When necessary to meet the needs of specific industries, we incorporate additional quality requirements in our systems.

At *PANDUIT®*, our commitment is Total Quality Assurance.



**PANDUIT® Products are on Display at Your  
Local PANDUIT® Distributor**



**Your local PANDUIT® Distributor carries top quality PANDUIT® products and offers many advantages and services to help lower your transaction costs:**

- Local stock for fast delivery and “Just-In-Time” requirements. Reduces your inventory costs.
- One stop for all your electrical needs because he stocks products from many manufacturers. One purchase order, less administrative and freight costs.
- Well trained personnel to answer any questions and to make sure you have the right product for the right job.

# PANDUIT® Stainless Steel Cable Ties and Accessories

## PAN-STEEL® Self-Locking Stainless Steel Ties



PANDUIT® *NO-SLIP*™ line of Stainless Steel Self-Locking Ties have a unique low-insertion force head design that keeps the tie locked, before or after tightening, regardless of its orientation or how tightly it is installed. With features like high strength, corrosion resistance, extreme temperature tolerance, fully rounded edges and special styles, these stainless steel ties are an excellent choice for a wide variety of applications and are designed to install easily for long service life under adverse conditions. All ties can be installed using PANDUIT® standard installation tools, or simply installed by hand.



### Ties — Standard Sizes



Standard, Light Heavy and Heavy

- Fully rounded edge design eliminates sharp edges for added protection and safety
- Available in a loop tensile strength of 200 lbs. for standard cross-section ties, 250 lbs. for light heavy cross section ties and 450 lbs. for heavy cross section ties
- Superior strength for most bundling applications
- Available in type 304 and 316 stainless steel which provides excellent resistance to temperature extremes, corrosion, weather and UV radiation

Part Number	Max. Bundle Dia. In. (mm)	Length In. (mm)	Width In. (mm)	Min. Loop Tensile Strength Lbs. (N)	Std. Pkg. Qty.*	Std. Ctn. Qty.
<b>MLT1S-CP</b>	1.00 (25)	5.0 (127)	.18 (4.6)	200 (890)	100	500
<b>MLT2S-CP</b>	2.00 (51)	7.9 (201)			100	500
<b>MLT2.7S-CP</b>	2.70 (69)	10.2 (259)			100	500
<b>MLT4S-CP</b>	4.00 (102)	14.3 (362)			100	500
<b>MLT6S-CP</b>	6.00 (152)	20.5 (521)			100	500
<b>MLT8S-CP</b>	8.00 (203)	26.8 (679)			100	500
<b>MLT2LH-LP</b>	2.00 (51)	7.9 (201)	.25 (6.4)	250 (1112)	50	250
<b>MLT4LH-LP</b>	4.00 (102)	14.3 (362)			50	250
<b>MLT6LH-LP</b>	6.00 (152)	20.5 (521)			50	250
<b>MLT8LH-LP</b>	8.00 (203)	26.8 (679)			50	250
<b>MLT2H-LP</b>	2.00 (51)	7.9 (201)			50	250
<b>MLT4H-LP</b>	4.00 (102)	14.3 (362)			50	250
<b>MLT6H-LP</b>	6.00 (152)	20.5 (521)	.31 (7.9)	450 (2000)	50	250
<b>MLT8H-LP</b>	8.00 (203)	26.8 (679)			50	250
<b>MLT10H-LP</b>	10.00 (254)	33.0 (838)			50	250
<b>MLT12H-Q</b>	12.00 (305)	42.0 (1067)			25	125

### Banding System



- For applications that require bundling various bundle diameters
- Provides versatility on job sites for any diameter with minimum inventory
- 304 Stainless Steel (316 available)

#### CUSTOM LENGTH BANDING SYSTEM

Part Number	Length	Width	Min. Loop Tensile Strength	Std. Pkg. Qty.	Std. Ctn. Qty.
<b>MBS-TLR</b>	250' (76m)	.18 (4.6)	100 (445)	1	n/a
<b>MBS-MR</b>	1000' (305m)			1	n/a
<b>MBH-TLR</b>	250' (76m)	.31 (7.9)	250 (1112)	1	n/a
<b>MBH-MR</b>	1000' (305m)			1	n/a

#### BANDING HEADS

Part Number	Length	Width	Min. Loop Tensile Strength	Std. Pkg. Qty.	Std. Ctn. Qty.
<b>MTHS-C</b>	n/a	n/a	.18 (4.6)	100 (445)	100
<b>MTHH-C</b>	n/a	n/a	.31 (7.9)	250 (1112)	100

\*Order the number of reels required in multiples of standard package quantities.

### WAVE-TY™ Superior Grip Steel Ties

- Loop tensile strength of 450 lbs. Provides superior strength for increased performance and reliability
- Available in 304 and 316 stainless steel
- The unique wave-form spring maintains a high tension grip on non-resilient objects; provides the strength of steel and the high tension of a steel spring



#### WAVE-TY™

Part Number	Max. Bundle Dia. In. (mm)	Length In. (mm)	Width In. (mm)	Min. Loop Tensile Strength Lbs. (N)	Std. Pkg. Qty.*	Std. Ctn. Qty.
<b>MLT2.7WH-LP</b>	2.70 (69)	10.2 (259)	.31 (7.9)	450 (2000)	50	250
<b>MLT4WH-LP</b>	4.00 (102)	14.2 (360)			50	250
<b>MLT6WH-LP</b>	6.00 (152)	20.4 (520)			50	250
<b>MLT8WH-LP</b>	8.00 (203)	26.8 (679)			50	250
<b>MLT10WH-LP</b>	10.00 (254)	33.0 (838)			50	250

\*Order the number of ties required in multiples of standard package quantities.

### Coated Stainless Steel Ties



- For communication and electrical cable
- The strength of steel, the protection of nylon; the nylon coating provides fully rounded plastic edges to protect cables
- Available with a loop tensile strength of 250 lbs.
- Base metal is 316 grade stainless steel for excellent resistance to temperature extremes, corrosion, weather, chemicals, salt sprays and UV radiation

#### NYLON 11 COATED 316 STAINLESS STEEL

Part Number	Max. Bundle Dia. In. (mm)	Length In. (mm)	Width In. (mm)	Min. Loop Tensile Strength Lbs. (N)	Std. Pkg. Qty.*	Std. Ctn. Qty.
<b>MLTC2H-LP316</b>	2.00 (50)	7.9 (201)	.31 (7.9)	250 (1112)	50	250
<b>MLTC4H-LP316</b>	4.00 (102)	14.2 (360)			50	250
<b>MLTC6H-LP316</b>	6.00 (152)	20.4 (520)			50	250
<b>MLTC8H-LP316</b>	8.00 (203)	26.8 (679)			50	250
<b>MLTC10H-LP316</b>	10.00 (254)	33.0 (838)			50	250

# PANDUIT® Stainless Steel Mounts and Marking Products

## Installation Tools



- Complete line of manual and pneumatic installation tools speeds installation
- Side-entry of cable ties into the tools, makes for quick and easy installation
- Automatic tension and cut-off capabilities available on select models
- High reliability, low maintenance, long life

Part Number	Description	Std. Pkg. Qty.*
<b>PPTMT</b>	Pneumatic-operated, tool controlled tension and cut-off for production applications.	1
<b>GS4MT</b>	MIL approved. Hand-operated, tool controlled tension and cut-off.	1
<b>K4M-BLD</b>	Replacement cutter blade for GS4MT.	1
<b>K4MTG</b>	Replacement tension gripper for GS4MT.	1
<b>ST2MT</b>	Hand-operated, installer controlled tension and cut-off.	1
<b>KT2MG</b>	Replacement tension gripper for ST2MT.	1
<b>HTMT</b>	Used to tension and coil the tail of tie.	1

\*Order the number of tools required in multiples of standard package quantities.

## PAN-STEEL® Accessories



### Cushion Sleeve

- Makes rigid bundles resilient, provides tighter tensioning
- Non-conductive insulator between clamp and bundle
- Material: black, neoprene

Part Number	For Clamp Width In. mm	Sleeve Width In. (mm)	Std. Pkg. Qty.*	Std. Ctn. Qty.
<b>PCSS-B-CR</b>	.18 (4.6)	.33 (8.4)	1	—
<b>PCSH-B-CR</b>	.31 (7.9)	.47 (12)	1	—

Bulk Pkg. -CR = 100' reel

\*Order the number of reels required in multiples of standard package quantities.

## Stainless Steel Mounts



Stainless Mount  
MTM1H-C

### Mount

- Low profile
- Utilizes only one hole for mounting
- Material: 304 Stainless Steel

Part Number	For MLT Tie Width In. (mm)	Mounting Method	Hole Diameter In. (mm)	Std. Pkg. Qty.*	Std. Ctn. Qty.
<b>MTM1H-C</b>	.18 (4.6)	#8 (4) Screw	.18 (4.6)	100	1000
<b>MTM1H10-C</b>	thru .31 (7.9)	#10 (5) Screw	.21 (5.4)	100	1000
<b>MTM1H25-C</b>	.31 (7.9)	1/4" (6) Screw	.28 (7.1)	100	1000



Push-Wing Mount  
MPWM-H56-Q



Push-Button Mount  
MBM-H25-Q

Part Number	For MLT Tie Width In. (mm)	Mounting Method In. (mm)	Panel Thickness In. (mm)	Std. Pkg. Qty.*	Std. Ctn. Qty.
<b>MPWM-H56</b>	.18 (4.6) thru .31 (7.9)	Inserted into pre-drilled hole 5/16 (8)	.031 (.8)-.094 (2.4)	25	250
<b>MBM-H25-Q</b>	.18 (4.6)	Inserted into pre-drilled hole .250 (6.4)	.031 (.8)-.125 (3.2)	25	250
<b>MTM2H-Q</b>	.18 (4.6) thru .31 (7.9)	#8 (4) Screw	—	25	250
<b>MTMBH-Q</b>	.18 (4.6) thru .31 (7.9)	Pre-drill hole size Max. size .625 (15.9)	Up to .500 max. (12.7)	25	250

Material: 304 Stainless Steel

\*Order the number of pieces required in multiples of standard package quantities.



Two-Way Mount  
MTM2H-Q



Bulkhead Mount  
MTMBH-Q

## Stainless Steel Marking Products

Use *PAN-STEEL*® Ties or Stainless Steel Strapping to provide identification in harsh environments. The ties and strapping can be stamped with available tooling or custom stamped upon request. Marker plates and metal embossed tape are also available.

### Marker Plates and Tags



- Attached with *PAN-STEEL*® Ties
- 304, 316 stainless steel, brass and aluminum available
- Can be used as a flag or wrap
- Various sizes and shapes available; round, square, rectangular, etc. Part numbers available upon request
- Can be custom marked by *PANDUIT*®. See page 79 for details

Part Number	Used with Clamp/Tie Width In. (mm)	Size - In. (mm)		Std. Pkg. Qty.*	Std. Ctn. Qty.
		Width	Length		
<b>MMP350-C</b>	.18 (4.6)	.75 (19)	3.50 (89)	100	1000
<b>MMP350W38-C</b>	.18 (4.6)	.38 (10)	3.50 (89)	100	1000
<b>MMP350H-C</b>	.18 (4.6) thru .31 (7.9)	.75 (19)	3.50 (89)	100	1000

\*Order the number of pieces required in multiples of standard package quantities.

# PANDUIT® Stainless Steel Marking Products

## Metal Embossed Tape System



- Hand operated embosser with 3/16" height characters (approx. 6 characters/inch)
- Hole punch (3/16" dia.) allows tape to be used as a wrap or flag marker, held on with *PAN-STEEL*® Ties

Characters include:

A	B	C	D	E	F	G	H	I	J	K	L	M
N	O	P	Q	R	S	T	U	V	W	X	Y	Z
2	3	4	5	6	7	8	9	.	/	-		

3/8" height (approx. 6 characters per inch).

Part Number	Description	Std. Pkg. Qty.*	Std. Ctn. Qty.
MEHT	Embosser, carrying case, (1) roll each of META and METS4 tape.	1	—

### TAPE

META-X	1/2" x 16'. roll Aluminum tape.	10	50
METS3-X	1/2" x 21' roll Stainless Steel (316 Grade).	10	50
METS4-X	1/2" x 21' roll Stainless Steel (304 Grade).	10	50

\*Order the number of pieces required in multiples of standard package quantities.

## Indenter Press



- For medium volume marking of ties, strapping or plates
- Manual operation with automatic indexing
- Interchangeable character wheel makes the press versatile and economical
- Press includes fixturing device to provide high quality marking

Characters include:

A	B	C	D	E	F	G	H	I	J	K	L	M	N
O	P	Q	R	S	T	U	V	W	X	Y	Z		
&	1	2	3	4	5	6	7	8	9	0	.	/	-

Part Number	Description	Std. Pkg. Qty.*
IMP094	Press with 3/32" character wheel.	1
IMP125	Press with 1/8" character wheel.	1
IMP187	Press with 3/16" character wheel.	1
MWK094	3/32" character wheel kit.	1
MWK125	1/8" character wheel kit.	1
MWK187	3/16" character wheel kit.	1
IMP-FIX	Interchangeable fixture for MMP172 series. MT series and the aluminum marker plates.	1

\*Order the number of pieces required in multiples of standard package quantities.

## Custom Marking Capabilities on *PANDUIT*® *PAN-STEEL*® Stainless Steel Cable Ties, Strapping, Metal Marker Plates/Tags Anodized Aluminum Locks.\*



*PANDUIT*® stainless steel cable ties, strapping, stainless steel, brass and aluminum marker plates/tags and anodized aluminum locks can be custom marked for identification of equipment, cables, hoses, pipes, conduit, etc. in petrochemical plants, power plants, pulp and paper mills, breweries, and many other applications. *PANDUIT*® in-house computer controlled custom marking systems provide sharp, crisp, high quality legends. Sequential numbering for serialization is available.

\*Anodized aluminum locks can only be marked by the laser system.



### Laser Marking System:

- Used on all stainless steel cable ties, strapping, metal marker plates/tags and anodized aluminum locks
- Graphics capability and **BOLD** block letters
- Upper and lower case character capability
- Alphanumeric and sequential numbering ability

#### Character Sizes \*\* Available:

- 1/8" (3.18mm)
- 1/4" (6.35mm)
- 3/16" (4.77mm)
- 5/16" (7.94mm)
- 1/2" (12.7mm)

### Embossing System:

- Used on metal marker plates and tags which are a maximum of .020" (0.5mm) thick
- Excellent for applications that are exposed to occasional painting and excessive dirt
- Upper case "raised" character capability only
- Alphanumeric and sequential numbering ability

#### Character Sizes \*\* Available:

- 1/8" (3.18mm)
- 3/16" (4.77mm)

\*\*Other character sizes available. For complete product information, specification or character information, contact 866-405-6659.

For more complete information on Stainless Steel Products, see *PANDUIT*® Brochure SA-SSCB01.

# PANDUIT® Stainless Steel Strapping System

## Stainless Steel Strapping



- Reduces installation time and leaves no sharp edges
- Burr-free sides
- 304 Stainless Steel
- Designed for use in critical applications where radiation, weathering, corrosion and temperature extremes are a concern
- Temperature range: -112°F (-80°C) to 1000°F (538°C)
- Fast and reliable alternative to wing seals

Part Number	Thickness in. (mm)	Width in. (mm)	Min. Loop Tensile Strength lbs. (N)	Max. Bundle Dia. in. (mm)	Length in. (mm)	Recommended PANDUIT® Installation Tool Part No.	Std. Pkg. Qty.*	Std. Ctn. Qty.
MS2W38T15-L4 MS4W38T15-L4 MS6W38T15-L4 MS8W38T15-L4 MS10W38T15-L4	.015 (.38)	.38 (9.5)	500 (2225)	2.00 (51) 4.00 (102) 6.00 (152) 8.00 (203) 10.00 (254)	11.8 (300) 18.0 (457) 24.4 (620) 30.7 (780) 37.0 (940)	BT1HT or BT2MS75	50 50 50 50 50	250 250 250 250 250
MS4W50T15-L4 MS6W50T15-L4 MS8W50T15-L4 MS10W50T15-L4	.015 (.38)	.50 (12.7)	700 (3115)	4.00 (102) 6.00 (152) 8.00 (203) 10.00 (254)	18.0 (457) 24.4 (620) 30.7 (780) 37.0 (940)	BT1HT or BT2MS75	50 50 50 50	250 250 250 250
MS4W63T15-L4 MS6W63T15-L4 MS8W63T15-L4 MS10W63T15-L4	.015 (.38)	.63 (15.9)	800 (3560)	4.00 (102) 6.00 (152) 8.00 (203) 10.00 (254)	18.0 (457) 24.4 (620) 30.7 (780) 37.0 (940)	BT1HT or BT2MS75	50 50 50 50	250 250 250 250

\*Order the number of strapping, and buckles required in multiples of standard package quantities.

## The PANDUIT® Method Reduces Installation Time:



1. Place strap around the material, insert tail of strap through buckle. Pull strapping tight and bend up to hold in place. Insert tail of strapping into tool nose section. Squeeze handles to tension.



2. Once proper tension is reached, maintain tension and raise tool 90°-120° over buckle and pull down on cutter lever, cutting strap.



3. Remove tool, press cut end down and toward retaining tab.



4. Using the closure level on the handle of the tool, bend retaining tab down and over cut end. Provides finished, safe, low profile closure.



## Custom Length Strapping System



- Provides job-site versatility with minimum inventory
- Gives custom capability on larger diameters
- 304 stainless steel
- Buckle is easy to install—just slip onto strapping and turn strapping back on bundle



Part Number	Thickness In. (mm)	Approx. Width In. (mm)	Used With Buckle	Std. Pkg. Qty.*	Std. Ctn. Qty.
<b>STRAPPING</b>					
MSW38T15-CR4	.015 (.38)	.38 (9.5)	MSBW38-C4	1*	—
MSW50T15-CR4	.015 (.38)	.50 (12.7)	MSBW50-C4	1*	—
MSW63T15-CR4	.015 (.38)	.63 (15.9)	MSBW63-C4	1*	—
<b>BUCKLES</b>					
MSBW38-C4	Used with .38" width strapping.			100	1000
MSBW50-C4	Used with .50" width strapping.			100	1000
MSBW63-C4	Used with .63" width strapping.			100	1000

\*Order the number of strapping, and buckles required in multiples of standard package quantities.

## Installation Tools



Hand operated tool. Adjustable tension control and lever actuated cut-off.

Part Number	Description	Std. Pkg. Qty.*
BT1HT	Installation tool. Used for all widths of PANDUIT® PAN-STEEL® strapping. Tensions, cuts strapping, and secures the buckle tab. Ratchet-type tool provides mechanical advantage for tensioning. Easy to operate.	1

\*Order the number of pieces required in multiples of standard package quantities.



# Wiring Accessories

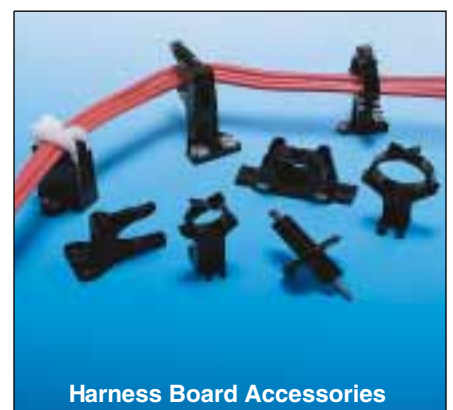
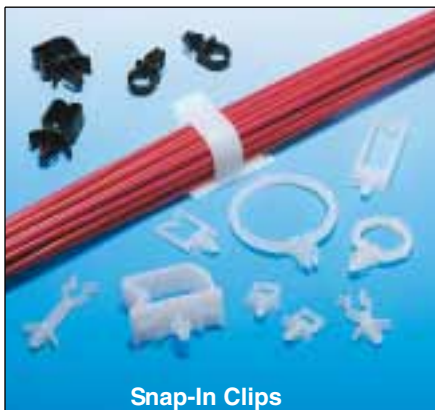

## Smart Ways to Lower Your Installed Cost

**PANDUIT® Wiring Accessories** offer you a broad range of products designed to speed installation and lower your installed costs—whatever your requirements. Plus, **PANDUIT®** provides experienced technical support to assure you get not only the best product for your application, but maximum benefit from its use.

For more information, in the U.S.A. call toll-free:

**Technical Support: 866-405-6657 or Customer Service: 800-777-3300**

## Contents

(See back of catalog for alphabetical index of part numbers referencing specific page numbers.)

<b>Selection of Styles</b> .....	<b>83</b>
<b>Cable Tie Accessories</b> .....	<b>85-107</b>
4-Way Adhesive Backed Mounts .....	85-86
4-Way Mounts Without Adhesive .....	86
Combination Adhesive Mount/Cable Tie .....	87
Adhesive Applied Mounts .....	88
Tie Mounts .....	89-92
Tie Anchor Mounts .....	93-94
Tie Plates .....	95
Right Angle Mounts/Lightening Hole Mounts .....	96
Clip-On Mounts .....	97
Push Mounts and Specialty Mounts .....	98-105
Tie Harness Mount System .....	100-101
Flat Cable Mount System .....	103
Marker Plates and Rolls/Marking Pens .....	105-106
TELCO Installation Products .....	107
<b>Wiring Accessories — used without cable ties</b> .....	<b>108-123</b>
Adjustable Releasable Clamp .....	108
Cord Clips .....	109-113
Flat Cable Mounts .....	114-115
Fixed Diameter “C” Clamps .....	116-117
Siding Clips .....	119
Snap-in Mounts/Clips .....	120-121
Circuit Board Posts and Locking Supports .....	122-123
<b>Harness Board Accessories</b> .....	<b>124-129</b>
<b>Communication Cable Management</b> .....	<b>130-133</b>
<b>Selection and Use of PANDUIT® Adhesive Mounts</b> .....	<b>134-136</b>
<b>Cable Management Bulk Package Part Numbers</b> .....	<b>137-138</b>
<b>Abrasion Protection Products</b> .....	<b>139-180</b>
Heat Shrink .....	140-161
Non-Shrink PVC Tubing .....	162-163
Spiral Wrap .....	164-167
Split Harness Wrap .....	168
Grommet Edging .....	169-171
Corrugated Loom Tubing .....	172-174
Braided Expandable Sleeving .....	175-176
Flammability Tests, Classifications, Technical Data .....	177-180
Abrasion Protection Bulk Package Part Numbers .....	181

Wiring Accessories are an integral part of *PANDUIT*® comprehensive selection of wire management products. These accessories help provide the lowest installed solution to routing, mounting, protecting wire, cable and optical fiber. These products are manufactured in an environment committed to design innovation, high quality and knowledgeable service to our customers. The key benefits of this commitment are:

- The highest quality manufacturing environment, including statistical process control to meet applicable international and domestic standards
- *PANDUIT*® teams up with a global network of Distributors to provide you with Just In Time shipping to eliminate your need for large inventories
- Fully staffed engineering and tool and die departments to assist in designing solutions to specific industry applications
- Continuous research on materials, adhesives and new technologies to provide you the latest product innovations



## Selection of Styles



### Cable Tie Accessories

These products are used with *PANDUIT*® Cable Ties to speed and simplify the mounting of wires, cables and tubing. Installation methods include adhesive-backed, user applied adhesive, screws, rivets or through-panel mount designs.



### Wiring Accessories

These products, including fixed and adjustable diameter accessories, are used without cable ties. Mounting methods include adhesive-backed, user applied adhesive, screws, rivets or through-panel designs.



### Harness Board Accessories

*PANDUIT*® unique selection of harness board accessories speeds the routing and forming of wire in harness fabrication. They hold wires at a uniform height above the board and are ideal for use with *PANDUIT*® manual and automatic cable tie tooling.



### Abrasion Protection Products

*PANDUIT*® offers a wide variety of abrasion protection products to protect wires, cables, hoses and tubing from abrasion. Heat shrink tubing, non-shrink PVC tubing, spiral wrap, grommet edging, corrugated loom tubing and braided expandable sleeving are available in a variety of sizes and materials to meet a broad range of indoor and outdoor applications.

# PANDUIT® Wiring Accessories Part Number System and Technical Data

## Part Number System Example

Part Description	Package Quantity	Color/Material
For Part Description and Mounting Method, refer to specific product tables in catalog.	X = 10 Q = 25 L = 50 C = 100 T = 200 D = 500 M = 1000	Blank = Natural 0 = Weather Resistant Black 8 = Gray 15 = Ivory 20 = Pigmented Black 30 = Heat Stabilized Nylon (Black) 69 = Flame Retardant Nylon (Natural) 76 = TEFZEL* (Blue) 100 = Polypropylene Weather Resistant (Black) 109 = Polypropylene (Green) 120 = Weather Resistant Nylon 12 (Black) 630 = Heat Stabilized Nylon 6 (Black) 639 = Heat Stabilized Nylon 6 (Natural) 702 = HALAR** (Maroon)

## Physical Properties and Colors of Wiring Accessory Materials

Design Criteria	General Purpose Nylon 6.6		Weather Resistant Nylon 6.6	Impact Modified Weather Resistant Nylon 6.6	Heat Stabilized Nylon 6.6	Flame Retardant Nylon 6.6		Glass Filled Flame Retardant Nylon 6.6
	Natural	Black	Black	Black	Black	Black	Natural	Black
Color	Natural	Black	Black	Black	Black	Black	Natural	Black
Part Number Suffix	None	20	0	0	30	60	69	None
UL Flammability — UL94	V-2	V-2	V-2	HB	V-2	V-0	V-0	V-0
Gamma Radiation Resistance	1 x 10 <sup>5</sup> Rads	1 x 10 <sup>5</sup> Rads	1 x 10 <sup>5</sup> Rads	N/A	1 x 10 <sup>5</sup> Rads	1 x 10 <sup>5</sup> Rads	1 x 10 <sup>5</sup> Rads	N/A
Water Absorption	1.2% (24 hrs)	1.2% (24 hrs)	1.2% (24 hrs)	1.2% (24 hrs)	1.2% (24 hrs)	1.1% (24hrs)	1.1% (24hrs)	0.7% (24hrs)
UV Resistance	Poor	Fair	Good	Good	Good	Poor	Poor	Poor
Maximum Continuous Use Temperature	185°F (85°C)	185°F (85°C)	185°F (85°C)	185°F (85°C)	257°F (125°C)	230°F (110°C)	230°F (110°C)	230°F (110°C)
Minimum Continuous Use Temperature	-40°F (-40°C)	-40°F (-40°C)	-40°F (-40°C)	-40°F (-40°C)	-40°F (-40°C)	-40°F (-40°C)	-40°F (-40°C)	-40°F (-40°C)

## Physical Properties and Colors of Wiring Accessory Materials

Design Criteria	Heat Stabilized Nylon 6.6		TEFZEL*	General Purpose Polypropylene	Weather Resistant Polypropylene	Polypropylene (Green)	HALAR**	General Purpose ABS		Weather Resistant ABS	Flame Retardant Polycarbonate	Acetal	PVC
	Black	Natural		White	Black	Green		White	Black	Black	Black		
Color	Black	Natural	Blue	White	Black	Green	Maroon	White	Black	Black	Black	Black	Gray, White
Part Number Suffix	630	639	76	None	100	109	702	None	20	0	None	None	8, 10
UL Flammability — UL94	HB	HB	V-0	HB	HB	HB	V-0	HB	HB	HB	V-0	HB	V-0
Gamma Radiation Resistance	N/A	N/A	2 x 10 <sup>6</sup> Rads	1 x 10 <sup>6</sup> Rads	1 x 10 <sup>6</sup> Rads	N/A	2 x 10 <sup>6</sup> Rads	N/A	N/A	N/A	N/A	N/A	N/A
Water Absorption (24 hours)	1.5% (24 hrs)	1.5% (24hrs)	<0.03% (24hrs)	0.1% (24 hrs)	0.1% (24hrs)	0.1% (24hrs)	<0.05% (24hrs)	0.3% (24hrs)	0.3% (24hrs)	0.3% (24hrs)	0.15% (24hrs)	0.43% (24 hrs)	0.3% (30 days)
UV Resistance	Fair	Poor	Excellent	Poor	Good	Poor	Excellent	Poor	Fair	Good	Good	Fair	Poor
Maximum Continuous Use Temperature	250°F (121°C)	250°F (121°C)	302°F (150°C)	221°F (105°C)	221°F (105°C)	221°F (105°C)	284°F (140°C)	150°F (65°C)	150°F (65°C)	150°F (65°C)	257°F (125°C)	194°F (90°C)	122°F (50°C)
Minimum Continuous Use Temperature	-40°F (-40°C)	-40°F (-40°C)	-50°F (-46°C)	-40°F (-40°C)	-40°F (-40°C)	-40°F (-40°C)	-50°F (-46°C)	-40°F (-40°C)	-40°F (-40°C)	-40°F (-40°C)	-40°F (-40°C)	-40°F (-40°C)	-40°F (-40°C)

Based on assumption of minimal loading, chemical attack and impact free conditions.

\*TEFZEL is a registered trademark of E. I. DuPont de Nemours Co.

\*\*HALAR is a registered trademark of Solvay Solexis, Inc.

## 4-Way Adhesive Backed Mounts



Lower your installed costs with fast, easy-to-install **PANDUIT®** adhesive-backed cable tie mounts. Four-way tie entry for easy orientation of wires or cables. **PANDUIT®** mounts are produced 2-up, 4-up, and with tear tabs for fast and easy liner removal to speed installation. For additional holding strength use #6 (M3) screws in the mounting hole(s). For specific information on adhesive properties and technical data on mount selection, see page 134-136.

**ABM1M**

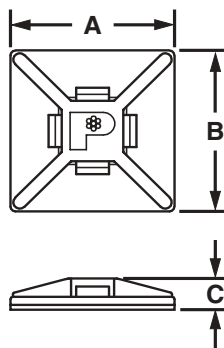

**ABMM**

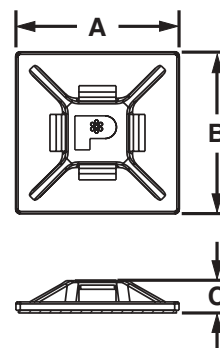

Part Number‡	Used With Cable Ties**	Dimensions in. (mm)			Material	Color	Where Used	Adhesive Type/Static Load lbs. (g)	Packaging*			
		A	B	C					Std. Pkg. Qty.	Std. Ctn. Qty.	Bulk Pkg. Qty.	Bulk Ctn. Qty.
<b>ABM1M-A-C</b>	M	.50 (12.7)	.50 (12.7)	.16 (4.0)	Nylon 6.6	White	Indoors	Rubber .13 (59)	100	500	1000	5000
ABM1M-AT-C	M	.50 (12.7)	.50 (12.7)	.16 (4.0)	Nylon 6.6	White	Indoors/ High Temp.	Acrylic .13 (59)	100	500	1000	5000
<b>ABMM-A-C</b>	M, I	.75 (19.1)	.75 (19.1)	.18 (4.6)	ABS	White	Indoors	Rubber .30 (136)	100	500	500	5000
<b>ABMM-A-C20</b>	M, I	.75 (19.1)	.75 (19.1)	.18 (4.6)	ABS	Black	Indoors	Rubber .30 (136)	100	500	—	—
ABMM-AT-C	M, I	.75 (19.1)	.75 (19.1)	.18 (4.6)	ABS	White	Indoors/ High Temp.	Acrylic .30 (136)	100	500	500	5000
ABMM-AT-C0	M, I	.75 (19.1)	.75 (19.1)	.18 (4.6)	ABS	Black	Outdoors/ High Temp.	Acrylic .30 (136)	100	500	500	5000

\*Parts shown for Std. Pkg. Qty. Order number of mounts required in multiples of package quantities.

‡Part Numbers listed are for Standard Materials in Standard Package Quantity.

For Bulk package part numbers, see page 137-138.

Cable tie cross section sizes: M = Miniature and I = Intermediate.

## 4-Way Adhesive Backed Mounts

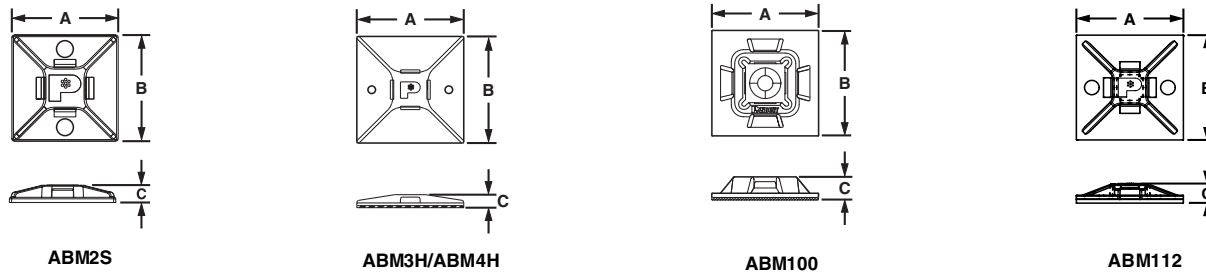

Part Number‡	Used With Cable Ties**	Dimensions in. (mm)			Material	Color	Where Used	Adhesive Type/Static Load lbs. (g)	Packaging*					
		A	B	C					Std. Pkg. Qty.	Std. Ctn. Qty.	Bulk Pkg. Qty.	Bulk Ctn. Qty.		
<b>ABM2S-A-C</b>	M, I, S	1.00 (25.4)	1.00 (25.4)	.16 (4.2)	ABS	White	Indoors	Rubber .50 (227)	100	500	500	5000		
<b>ABM2S-AT-C</b>							Indoors/High Temp.	Acrylic .50 (227)	100	500	500	5000		
<b>ABM2S-AT-C0</b>							Outdoors/High Temp.		100	500	500	5000		
<b>ABM100-A-C</b>				.23 (5.8)	Nylon 6.6	White	Indoors	Rubber .50 (227)	100	500	500	5000		
<b>ABM100-AT-C</b>							Outdoors/High Temp.	Acrylic .50 (227)	100	500	500	5000		
<b>ABM100-AT-C0</b>														
<b>ABM112-A-C</b>				1.12 (28.6)	1.12 (28.6)	.14 (4.1)	Nylon 6.6	White	Indoors	Rubber .63 (286)	100	500	500	5000
<b>ABM112-AT-C</b>									Indoors/High Temp.	Acrylic .63 (286)	100	1000	500	5000
<b>ABM112-AT-C0</b>									Outdoors/High Temp.		100	1000	500	5000
<b>ABM3H-A-L</b>	M, I, S, HS, LH, H, HLM ■	1.50 (38.1)	1.50 (38.1)	.25 (6.4)	White	Indoors		Rubber 1.12 (513)	50	500	200	1000		
<b>ABM3H-AT-L</b>						Indoors High Temp.		Acrylic 1.12 (513)	50	500	200	1000		
<b>ABM4H-A-L</b>						Indoors			Rubber 2.0 (907)	50	500	200	1000	
								<b>ABM4H-AT-L</b>		Indoors/High Temp.	Acrylic 2.0 (907)	50	500	200

### 4-WAY MOUNTS WITHOUT ADHESIVE

Part Number‡	Used With Cable Ties**	Dimensions in. (mm)			Material	Color	Where Used	Adhesive Type/Static Load lbs. (g)	Packaging*						
		A	B	C					Std. Pkg. Qty.	Std. Ctn. Qty.	Bulk Pkg. Qty.	Bulk Ctn. Qty.			
<b>ABMM-D</b>	M, I	.75 (19.1)	.75 (19.1)	.14 (3.6)	ABS	White	Indoors	User supplied adhesive	—	—	500	5000			
<b>ABM2S-S6-D</b>	M, I, S	1.00 (25.4)	1.00 (25.4)	.16 (4.2)				Nylon 6.6	#6 (M3) Screws	User supplied adhesive and/or (2) #6 (M3) Screws	—	—	500	5000	
<b>ABM100-S6-C</b>								Flame Retard. Nylon 6.6		Natural	100	1000	500	5000	
<b>ABM100-S6-C69</b>											100	1000	500	5000	
<b>ABM112-S6-C</b>				Nylon 6.6				White	100	1000	500	5000			
<b>ABM112-S6-C69</b>									Flame Retard. Nylon 6.6	Natural	100	500	500	5000	
<b>ABM3H-S6-T</b>				M, I, S, HS, LH, H, HLM ■				1.50 (38.1)	1.50 (38.1)	.21 (5.2)	Nylon 6.6	White	Indoors	User supplied adhesive and/or (2) #6 (M3) Screws	—
<b>ABM4H-S6-T</b>	2.00 (50.8)	2.00 (50.8)	—												—

■Used with PANDUIT® HLM series Hook & Loop Cable Ties found on page 40.

## Combination Adhesive Mount/Cable Tie

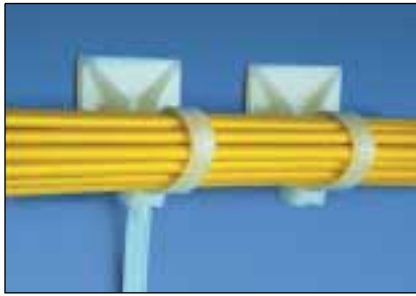

Adhesive mount and cable tie molded as one piece help reduce inventory costs. Mount portion features ramp to guide tip into tie head and holes to install two (2) optional #6 screws for added mounting strength. Available with locking or releasable tie. Extended adhesive liner release tab on mount for fast liner removal.

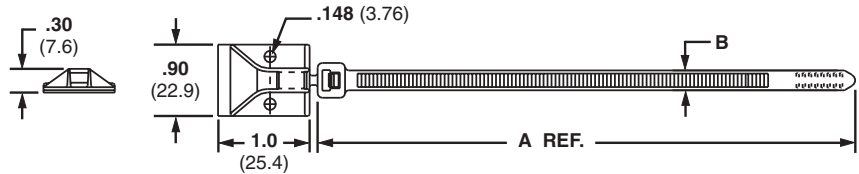

Part Number‡	Cable Tie Specifications				Recommended PANDUIT® Installation Tool	Material	Color	Adhesive Type/Static Load lbs. (g)	Packaging*			
	Length A in. (mm)	Width B in. (mm)	Max. Bundle Dia. in. (mm)	Min. Loop Tensile Strength Lbs. (N)					Std. Pkg. Qty.	Std. Ctn. Qty.	Bulk Pkg. Qty.	Bulk Ctn. Qty.
Locking PLA2S-A-Q	7.4 (188)	.19 (4.8)	1.85 (47)	50 (222)	GTS, GS2B, PPTS, PTS, STS2 or STH2	Nylon 6.6	White	Rubber .45 (204)	25	250	100	1000
Releasable PRA2S-A-Q					Hand Installed Only				25	250	100	1000

## Snap-In Cable Tie Mounts



Integral retaining notch holds cable tie head in place below bundle; eliminates protruding tie head and facilitates one hand tie threading.

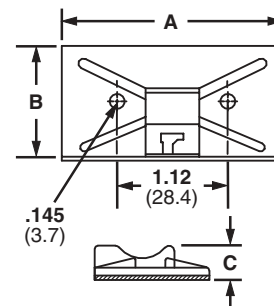

Part Number‡	Used With Cable Ties**	Dimensions in. (mm)			Material	Color	Where Used	Mounting Method	Packaging*			
		A	B	C					Std. Pkg. Qty.*	Std. Ctn. Qty.	Bulk Pkg. Qty.	Bulk Ctn. Qty.
<b>ADHESIVE BACKED</b>												
SMS-A-C	S	2.00 (50.8)	1.00 (25.4)	.31 (7.9)	ABS	White	Indoors	Rubber Adhesive Static Load 1.0 lbs. (454g)	100	500	500	5000
<b>SCREW MOUNT</b>												
SMS-S6-D	S	2.00 (50.8)	1.00 (25.4)	.31 (7.9)	ABS	White	Indoors	(2) #6 (M3) Screws	—	—	500	5000

\*Order the number of mounts required in multiples of package quantities.

‡Part Numbers listed are for Standard Materials in Standard Package Quantity. For Bulk package part numbers, see page 137-138.

\*\*Recommended cable ties: PLT1S, PLT1.5S, PLT2S, PRT1.5S, PRT2S. Cable Tie Cross Section: S = Standard.

## Epoxy Applied Mounts



These mounts are designed for application with **PANDUIT® EMA Epoxy**. Provides a fast, strong, economical method to secure wire or cable to steel, aluminum, glass, wood and most other surfaces. Especially well suited to construction and maintenance applications. Eliminates the need to drill holes.

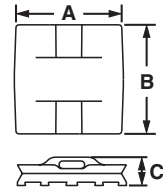

Part Number‡	Used With Cable Ties**	Dimensions in. (mm)			Material	Color	Where Used	Mounting Method	Max. Static Load lbs. (g)●	Packaging*			
		A	B	C						Std. Pkg. Qty.	Std. Ctn. Qty.	Bulk Pkg. Qty.	Bulk Ctn. Qty.
EMS-A-C	M, I, S	.98 (24.9)	.98 (24.9)	.26 (6.6)	Nylon 6.6	Natural	Indoors	EMA Epoxy	10 (4540)	100	500	500	1000
EMS-A-CO					Weather Resistant Nylon 6.6	Black	Outdoors			100	500	500	5000

## Epoxy Applied Swivel Mounts



Mount swivels 360° to assure proper orientation with harness. Four inspection holes to check adhesive coverage.

Material:  
**Base and Rivet:** Aluminum  
**Mount:** Natural Nylon 6.6 — Indoors

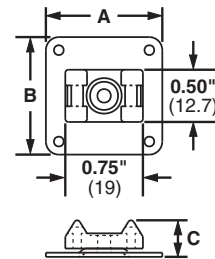

Part Number‡	Used With Cable Ties	Dimensions in. (mm)			Where Used	Mounting Method	Max. Static Load lbs. (g)●	Packaging*			
		A	B	C				Std. Pkg. Qty.	Std. Ctn. Qty.	Bulk Pkg. Qty.	Bulk Ctn. Qty.
ASMS-A-X	M, I, S	1.125 (28.6)	1.125 (28.6)	.35 (8.9)	Indoors	EMA Epoxy	10 (4540)	10	50	200	1000

## Epoxy Adhesive and Mount Kits



EMSK3-1-X0 Epoxy Kit with mounts.  
Packed in sturdy foil pouch



EMSK-12-4-12-X0 Epoxy Kit with mounts and cable ties

EMA Epoxy supplied in convenient two-compartment mixer cup with a mixer stick for each cup. Each cup contains adhesive for three (3) EMS or ASMS mounts. Epoxy hardens in about five (5) minutes. Supports about 5 lbs. after first 15 minutes. After full 24-hour curing time, bonding strength will exceed 50 lbs. on clean, grease-free surface. Note: Not recommended for polyethylene and polypropylene.



EMA EPOXY

Part Number‡	Used With Cable Ties**	Where Used	Contents of Each Kit				Packaging*	
			Epoxy Cups	Mixer Sticks	EMS Mounts	Cable Ties	Std. Pkg. Qty.	Bulk Pkg. Qty.
<b>EPOXY ADHESIVE ONLY</b>								
EMA-X	—	Indoor/ Outdoor	10	10	None	None	10 Kits	—
<b>EPOXY MOUNTING KIT WITH EMS MOUNTS</b>								
EMSK3-1-X0	M, I, S	Indoor/ Outdoor	1	1	3	None	10 Kits	100 Kits
<b>EPOXY MOUNTING KIT WITH EMS MOUNTS AND CABLE TIES</b>								
EMSK3-1-3-0	M, I, S	Indoor/ Outdoor	1	1	3	3 ea. PLT2S-0	1 Kit	10 Kits
EMSK12-4-12-X0	M, I, S		4	4	12	12 ea. PLT2S-0	10 Kits	100 Kits



## Tie Mounts — Mechanically Applied

Unique cradle design provides maximum stability and rigidity to the wire bundle. Screw or rivet installed.

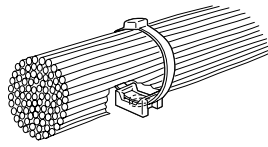

**CAI US**  
 Except  
 TM1S4-M69  
 TM2S8-C100  
 TM3S8-C69  
 TM3S8-C100

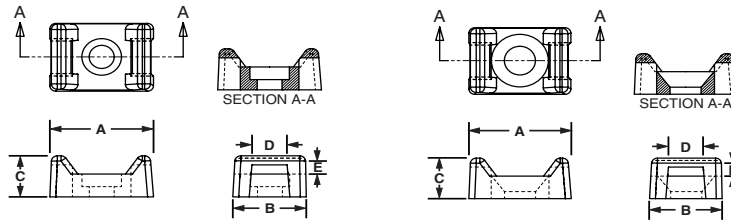

TM-S-

TM-R-

Part Number†	Used With Cable Ties**	Dimensions in. (mm)					Material	Color	Where Used	Mounting Method	Packaging*			
		A	B	C	D	E					Std. Pkg. Qty.	Std. Ctn. Qty.	Bulk Pkg. Qty.	Bulk Ctn. Qty.
TM1S4-C	M	.513 (13.0)	.316 (8.0)	.230 (5.8)	.130 (3.3)	.067 (1.7)	Nylon 6.6	Natural	Indoors	#4 (M2.5) Screw or Tapered Rivet	100	500	1000	5000
TM1S6-C		#6 (M3) Screw or Tapered Rivet	100	500	1000	5000								
TM2S6-C	#8 (M4) Screw or Tapered Rivet	100	500	1000	5000									
TM2S8-C	#6 (M3) Screw or Countersunk Rivet	100	500	1000	5000									
TM2R6-C	#8 (M4) Screw or Tapered Rivet	100	500	1000	5000									
TM3S8-C	#10 (M5) Screw or Tapered Rivet	100	500	1000	5000									
TM3S10-C	1/4 (M6) Screw or Tapered Rivet	100	500	1000	5000									
TM3S25-C	#6 (M3) Screw or Countersunk Rivet	100	500	1000	5000									
TM3R6-C														
	M, I, S	.630 (16.0)	.425 (10.8)	.275 (7.0)	.215 (5.5)	.060 (1.5)								
	M, I, S, HS, LH	.858 (21.8)	.610 (15.5)	.375 (9.5)	.320 (8.1)	.080 (2.0)	Nylon 6.6	Natural	Indoors					

Hole Diameter — in. (mm)		
Part Number	Hole Dia.	Counterbore Dia.
TM1S4	.120 (3.0)	.230 (5.8)
TM1S6	.150 (3.8)	.280 (7.1)
TM2S6	.150 (3.8)	.280 (7.1)
TM2S8	.180 (4.6)	.320 (8.1)
TM2R6	.190 (4.8)	Countersunk
TM3S8	.180 (4.6)	.320 (8.1)
TM3S10	.200 (5.1)	.390 (9.9)
TM3S25	.260 (6.6)	.510 (12.9)
TM3R6	.190 (4.8)	Countersunk

Additional Tie Mount Part Numbers Available in specified materials. All are available as standard PANDUIT® parts				
Heat Stabilized Nylon	Flame Retardant Nylon	Weather Resistant Nylon	Weather Resistant Polypropylene	TEFZEL***
TM1S4-M30 TM1S6-M30 TM2R6-M30 TM2S6-M30 TM2S8-M30 TM2S8-M69 TM3S8-M30 TM3S10-M30 TM3S25-M30	TM1S4-M69 TM1S6-M69 TM2S6-M69 TM2S8-M69 TM3S8-C69 TM3S10-M69	TM1S6-M0 TM2R6-M0 TM2S6-M0 TM2S8-M0 TM3R6-M0 TM3S10-Q0 TM3S10-M0 TM3S25-M0	TM2S8-C100 TM3S8-C100 TM3S8-M100	TM3S10-C76 TM3S8-C76 TM2S8-C76

\*\*\*TEFZEL is a registered trademark of E.I. DuPont de Nemours Co.

\*Order the number of mounts required in multiples of package quantities.  
 †Part Numbers listed are for Standard Materials in Standard Package Quantity.  
 For Bulk package part numbers, see page 137-138.  
 \*\*Cable Tie Cross Section Sizes: M = Miniature, I = Intermediate, S = Standard, HS = Heavy Standard and LH = Light-Heavy.

## Extra-Heavy Tie Mounts

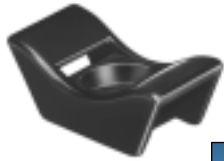

Mounts designed especially for use with *PANDUIT*® Extra-Heavy cross-section ties for mounting cable, large wire bundles or tubular shapes.

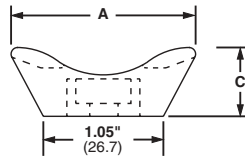

Part Number	Hole Diameter	Counterbore Diameter
TMEHS8	.18" (4.3 mm)	.51" (13.0)
TMEHS10	.20" (5.1 mm)	.51" (13.0)
TMEHS25	.26" (6.6 mm)	.51" (13.0)

Except  
TMEH-S10-C100  
TMEH-S10-C109

Part Number†	Used With Cable Ties**	Dimensions in. (mm)			Material	Color	Where Used	Mounting Method	Packaging*			
		A	B	C					Std. Pkg. Qty.	Std. Ctn. Qty.	Bulk Pkg. Qty.	Bulk Ctn. Qty.
TMEH-S8-Q0	M, I, S, HS, LH, EH, HLM ■	1.65 (42)	.74 (19)	.61 (15.5)	Weather Resistant Nylon 6.6	Black	Outdoors	#8 (M4) Screw	25	250	100	500
TMEH-S10-Q0								#10 (M5) Screw	25	250	100	500
TMEH-S25-Q0								1/4 (M6) Screw	25	250	100	500
TMEH-S10-C100					#10 (M5) Screw			—	—	100	500	
TMEH-S10-C109								—	—	100	500	

## Swivel Cable Tie Mounts

The two TM style mounts are securely fastened together with a rivet that allow both mounts to swivel. The Swivel Mount can join bundles of cable, tubing or hoses that may need to move or are not parallel. This mount is also a great way to separate bundles to avoid abrasion.

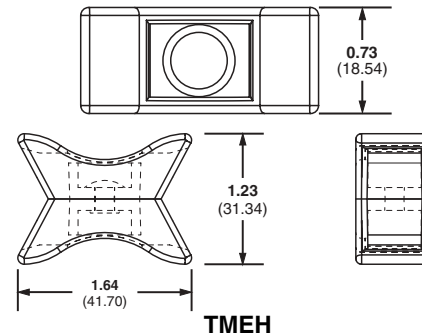
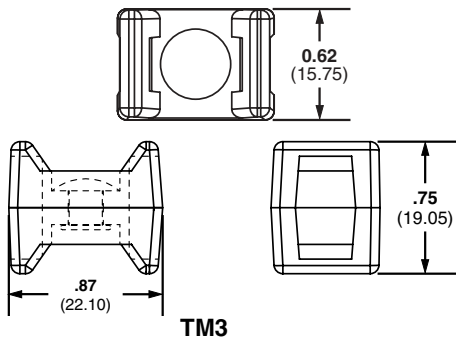
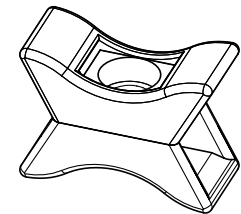
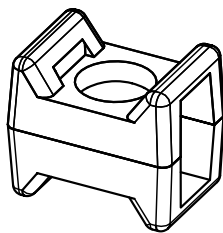

Part Number	Used With Cable Ties**	Dimensions in. (mm)	Pull Apart Force	Material	Color	Where Used	Packaging*	
							Std. Pkg. Qty.	Std. Ctn. Qty.
TM3-X2-C0	M, I, S, HS, LH	See Drawing	120 lbs.	Weather Resistant Nylon 6.6	Black	Outdoors/ Indoors	100	1000
TMEH-X2-L0	M, I, S, HS, LH, EH, HLM ■		250 lbs.				50	500

## Stud Tie Mounts

Easily applied to bolts or studs with a light hammer blow or turning of the mount. The mounts are designed for use with cable ties to mount wire bundles, air, water and hydraulic lines.

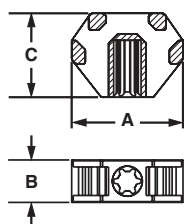

TMSTLHS Type

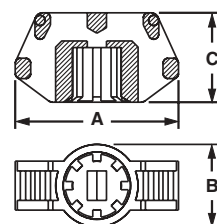

TMSTHS Type

Part Number‡	Used With Cable Ties**	Dimensions in. (mm)			Material	Color	Where Used	Mounting Method	Packaging*			
		A	B	C					Std. Pkg. Qty.	Std. Ctn. Qty.	Bulk Pkg. Qty.	Bulk Ctn. Qty.
TMSTLHS5-M0	M, I, S, HS, LH	1.25 (31.8)	.48 (12.2)	.95 (24.1)	Impact Modified Weather Resistant Nylon 6.6	Black	Outdoors	#12 Stud Dia. (5 mm)	100	1000	1000	5000
TMSTLHS6-M0								1/4" Stud Dia. (6 mm)	100	1000	1000	5000
TMSTLHS8-M0								5/16" Stud Dia. (8 mm)	100	1000	1000	5000
TMSTHS10-D0	M, I, S, HS, LH, H	1.99 (50.6)	1.01 (25.6)	1.10 (27.9)				3/8" Stud Dia. (10 mm)	100	1000	500	500
TMSTHS13-D0								1/2" Stud Dia. (13 mm)	100	1000	500	500
TMSTHS16-D0								5/8" Stud Dia. (16 mm)	100	1000	500	500
TMSTHS19-D0								3/4" Stud Dia. (19 mm)	100	1000	500	500

## Spacer Mount



Maintain a standoff from the frame rail in Chassis Tie applications. Ideal for applications where bundles must be secured away from the frame to avoid abrasion.

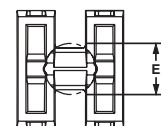
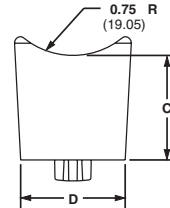
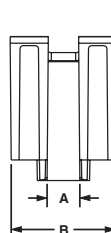

Part Number‡	Used With Cable Ties	Dimensions in. (mm)					Material	Color	Minimum Panel Thickness	Packaging*			
		A Cable Tie Channel in. (mm)	B Width in. (mm)	C Standoff Height in. (mm)	D Base Depth in. (mm)	E Recommended Panel Hole Dia. in. (mm)				Std. Pkg. Qty.	Std. Ctn. Qty.	Bulk Pkg. Qty.	Bulk Ctn. Qty.
TMSH50-T300	SSPM2.5H-L300 SSPM4H-L300	.310 (7.875)	1.00 (25.4)	1.00 (25.4)	1.00 (25.4)	.50 (12.7)	Weather Resistant Heat Stabilized Nylon 6.6	Black	0.188 (4.78)	100	1000	200	1000

\*Order the number of mounts required in multiples of package quantities.

‡Part Numbers listed are for Standard Materials in Standard Package Quantity. For Bulk package part numbers, see page 137-138.

\*\*Cable Tie Cross Section Sizes: M = Miniature, I = Intermediate, S = Standard, HS = Heavy Standard, LH = Light-Heavy and H = Heavy.

## Tie Mounts — Applied with User Supplied Adhesives

Apply cyanoacrylic or another type adhesive to mount surface. Any adhesive selected should be user-tested to assure suitability for the actual application. Mounts should be installed on a clean, dry and grease-free surface. Bond strength depends on adhesive used.

### Low Profile Mount — AM2

Low profile design keeps bundle close to mounting surface where overhead space is limited.

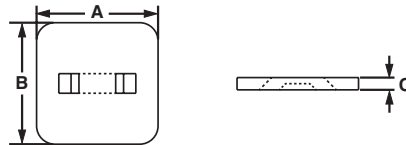

Part Number‡	Used With Cable Ties**	Dimensions in. (mm)			Material	Color	Where Used	Mounting Method	Packaging*			
		A	B	C					Std. Pkg. Qty.	Std. Ctn. Qty.	Bulk Pkg. Qty.	Bulk Ctn. Qty.
AM2-C	M, I, S	1.22 (31.2)	1.22 (31.2)	.125 (3.2)	Nylon 6.6	Natural	Indoors	User Supplied Adhesive	100	500	1000	5000

### TM1A, TM2A, TM3A

Solid flat bottom surface provides maximum adhesive area.

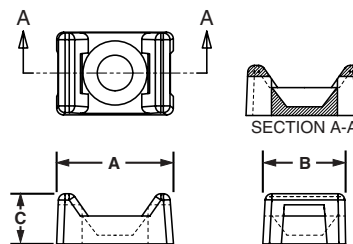
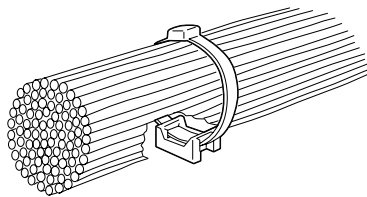
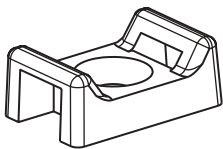

Part Number‡	Used With Cable Ties**	Dimensions in. (mm)			Material	Color	Where Used	Mounting Method	Packaging*			
		A	B	C					Std. Pkg. Qty.	Std. Ctn. Qty.	Bulk Pkg. Qty.	Bulk Ctn. Qty.
TM1A-C	M	.513 (13.0)	.316 (8.0)	.230 (5.8)	Nylon 6.6	Natural	Indoors	User Supplied Adhesive	100	1000	1000	10000
TM2A-C	M, I, S	.630 (16.0)	.425 (10.8)	.275 (7.0)					100	500	1000	5000
TM3A-C	M, I, S, HS, LH	.875 (22.2)	.620 (15.8)	.375 (9.5)					100	500	1000	5000

## Screw Applied Tie Anchor Mounts

Low profile and versatile, these screw-installed mounts can be ideal for applications where space is limited. Designed for four-way cable tie insertion, this mount can be mounted in-line or perpendicular to the wire bundle.

### TA1 Anchor

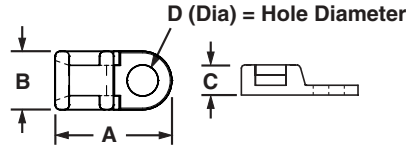
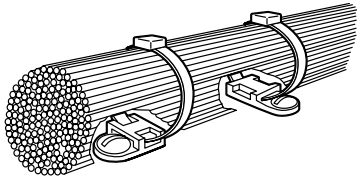

Part Number‡	Used With Cable Ties**	Dimensions in. (mm)				Material	Color	Where Used	Mounting Method	Packaging*			
		A	B	C	D					Std. Pkg. Qty.	Std. Ctn. Qty.	Bulk Pkg. Qty.	Bulk Ctn. Qty.
<b>TA1S8-C</b>	M, I, S	.75 (19.0)	.38 (9.5)	.20 (5.1)	.17 (4.3)	Nylon 6.6	Natural	Indoors	#8 (M4) Screw	100	500	1000	5000
<b>TA1S8-M0</b>						Weather Resistant Nylon 6.6	Black			—	—	1000	5000
<b>TA1S8-M30</b>						Heat Stabilized Nylon	Black			—	—	1000	5000
<b>TA1S8-M69</b>						Flame Retardant Nylon 6.6	Natural			—	—	1000	5000
<b>TA1S10-C</b>					.20 (5.1)	Nylon 6.6	Natural		#10 (M5) Screw	100	500	1000	5000
<b>TA1S10-M0</b>						Weather Resistant Nylon 6.6	Black			—	—	1000	5000

### TA2 Anchor

This mount is installed perpendicular to the wire bundle. Elongated slot permits installing the screw and adjusting mount position with the bundle attached.

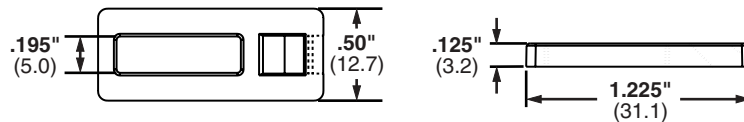
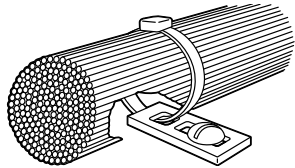

Part Number‡	Used With Cable Ties**	Dimensions in. (mm)	Material	Color	Where Used	Mounting Method	Packaging*			
							Std. Pkg. Qty.	Std. Ctn. Qty.	Bulk Pkg. Qty.	Bulk Ctn. Qty.
<b>TA2-C</b>	M, I, S	See Drawing	Nylon 6.6	Natural	Indoors	#10 (M5) Screw	100	500	1000	5000

\*Order the number of mounts required in multiples of package quantities.

‡Part Numbers listed are for Standard Materials in Standard Package Quantity.

For Bulk package part numbers, see page 137-138.

\*\*Cable Tie Cross Section Sizes: M = Miniature, I = Intermediate and S = Standard.

# PANDUIT® Cable Tie Mounts

## Screw Applied Low Profile Mounts

Designed to secure wire bundles where space is limited.

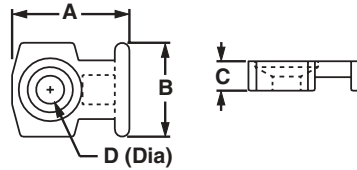
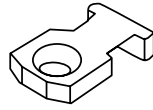
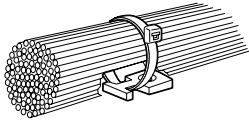

Part Number‡	Used With Cable Ties**	Dimensions in. (mm)				Material	Color	Where Used	Mounting Method	Packaging*			
		A	B	C	D					Std. Pkg Qty.	Std. Ctn. Qty.	Bulk Pkg. Qty.	Bulk Ctn. Qty.
LPMM-S2-C	M	.40 (10.2)	.32 (8.1)	.10 (2.5)	.095' (2.4)	Nylon 6.6	Natural	Indoors	#2 (M2) Flathead Screw	100	1000	1000	10,000
LPMM-S5-C	M	.40 (10.2)	.32 (8.1)	.10 (2.5)	.130 <sup>2</sup> (3.3)			Indoors	#5 (M3) Flathead Screw	100	1000	1000	10,000
LPMS-S8-C	M, I, S	.75 (19.1)	.50 (12.7)	.12 (3.0)	.170 <sup>2</sup> (4.3)			Indoors	#8 (M4) Flathead Screw	100	1000	1000	5000

NOTE 1: Combination Counterbore and Countersunk Hole (.088" (2.2) Dia. rivet can also be used).  
NOTE 2: Countersunk Hole

## Knock-In Low Profile Mounts

Secures wires to any pre-drilled panel. Can be installed in any panel thickness. Eliminates screws.

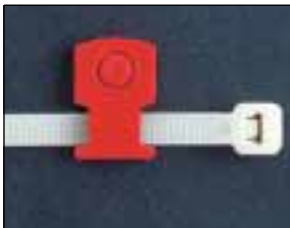

Easy to Install:

1. Push rivet in pre-drilled panel hole.
2. Use *PANDUIT*® Rivet Installation Tool (TNR) or hammer to drive the pin flush to the base. This drives the rivet into the hole and secures the mount.
3. Attach wires to the mount with cable tie.

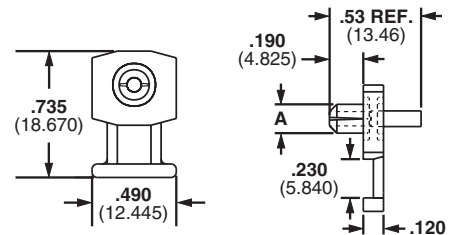

Part Number‡	Used With Cable Ties**	A	Dimensions in. (mm)	Hole Size	Material	Color	Where Used	Mounting Method	Packaging*			
									Std. Pkg. Qty.	Std. Ctn. Qty.	Bulk Pkg. Qty.	Bulk Ctn. Qty.
KIMS-H366-C2	M, I, S	.155 (3.9)	See Drawing	.144 (3.7)	Nylon 6.6	Red	Indoors	Integral Push Rivet	100	500	1000	5000
KIMS-H430-C6	M, I, S	.180 (4.6)	See Drawing	.169 (4.3)	Nylon 6.6	Blue		Integral Push Rivet	100	1000	1000	5000
KIMS-H500-C4	M, I, S	.202 (5.1)	See Drawing	.196 (5.0)	Nylon 6.6	Yellow		Integral Push Rivet	100	500	1000	5000

## Tie Plates

Screw applied. Each tie plate has a slotted mounting hole to accommodate various fastener spacings.

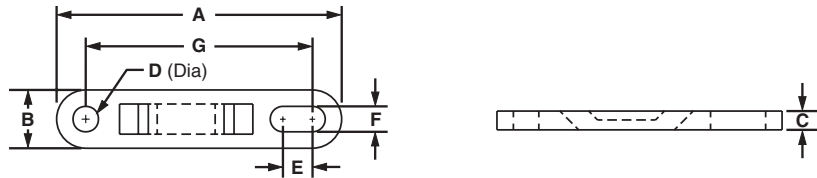

Part Number‡	Used With Cable Ties**	Dimensions in. (mm)							Color & Material	Where Used	Mounting Method ● Screw Size	Packaging*			
		A	B	C	D	E	F	G				Std. Pkg. Qty.	Std. Ctn. Qty.	Bulk Pkg. Qty.	Bulk Ctn. Qty.
TP2-C	M, I, S, HS	1.98 (50.3)	.50 (12.7)	.125 (3.2)	.200 (5.1)	.40 (10.2)	.200 (5.1)	1.60 (40.6)	Natural Nylon 6.6	Indoors	#10 (M5)	100	1000	1000	5000
TP4H-C		3.08 (78.2)	.62 (15.7)	.203 (5.2)	.270 (6.9)	.31 (7.9)	.270 (6.9)	2.50 (63.5)			1/4 (M6)	100	1000	500	2500

## Multiple Tie Plates

Screw applied. Used to secure closely spaced wire bundles.

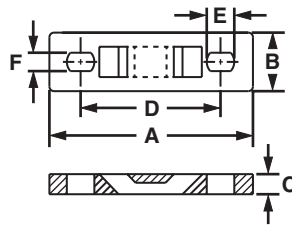
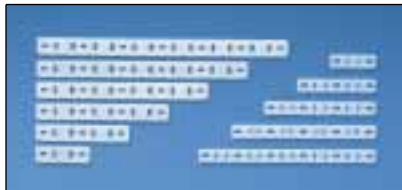
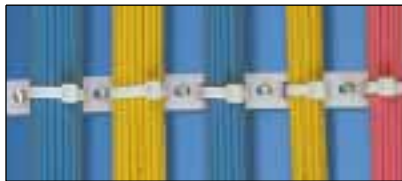

Part Number‡	No. of Bcls.	Used With Cable Ties**	Dimensions in. (mm)						Material & Where Used	Mil. Std. Part No.	Mounting Method ● Screw Size	Packaging*			
			A	B	C	D	E	F				Std. Pkg. Qty.	Std. Ctn. Qty.	Bulk Pkg. Qty.	Bulk Ctn. Qty.
MTP1S-E6-C MTP1S-E10-C	1	M, I, S	1.75 (44.5)	.50 (12.7)	.125 (3.2)	1.25 (31.8)	.220 (5.58) .330 (7.62)	.147 (3.73) .200 (5.08)	Natural Nylon 6.6, Indoors	MS3339-1	#6 (M3)	—	—	100	1000
MTP1H-E6-C MTP1H-E10-C		M, I, S, HS, LH, H	2.09 (53.1)	.62 (15.7)	.203 (5.2)	1.50 (38.1)	.220 (5.58) .300 (7.62)	.147 (3.73) .200 (5.08)		MS3339-6	#6 (M3)	—	—	100	1000
MTP2S-E6-C MTP2S-E10-C	2	M, I, S	3.00 (76.2)	.50 (12.7)	.125 (3.2)	1.25 (31.8)	.220 (5.58) .300 (7.62)	.147 (3.73) .200 (5.08)		MS3339-2	#6 (M3)	—	—	100	1000
MTP2H-E6-C MTP2H-E10-C		M, I, S, HS, LH, H	3.59 (91.2)	.62 (15.7)	.203 (5.2)	1.50 (38.1)	.220 (5.58) .300 (7.62)	.147 (3.73) .200 (5.08)		MS3339-7	#6 (M3)	—	—	100	1000
MTP3S-E6-C MTP3S-E10-C	3	M, I, S	4.25 (108.0)	.50 (12.7)	.125 (3.2)	1.25 (31.8)	.220 (5.58) .300 (7.62)	.147 (3.73) .200 (5.08)		MS3339-3	#6 (M3)	—	—	100	1000
MTP3H-E6-C MTP3H-E10-C		M, I, S, HS, LH, H	5.09 (129.3)	.62 (15.7)	.203 (5.2)	1.50 (38.1)	.220 (5.58) .300 (7.62)	.147 (3.73) .200 (5.08)		MS3339-8	#6 (M3)	—	—	100	1000
MTP4S-E6-C MTP4S-E10-C	4	M, I, S	5.50 (139.7)	.50 (12.7)	.125 (3.2)	1.25 (31.8)	.220 (5.58) .300 (7.62)	.147 (3.73) .200 (5.08)		MS3339-4	#6 (M3)	—	—	100	1000
MTP4H-E6-C MTP4H-E10-C		M, I, S, HS, LH, H	6.59 (167.4)	.62 (15.7)	.203 (5.2)	1.50 (38.1)	.220 (5.58) .300 (7.62)	.147 (3.73) .200 (5.08)		MS3339-9	#6 (M3)	—	—	100	1000
MTP5S-E6-C MTP5S-E10-C	5	M, I, S	6.75 (171.5)	.50 (12.7)	.125 (3.2)	1.25 (31.8)	.220 (5.58) .300 (7.62)	.147 (3.73) .200 (5.08)		MS3339-5	#6 (M3)	—	—	100	1000
MTP5H-E6-C MTP5H-E10-C		M, I, S, HS, LH, H	8.09 (205.5)	.62 (15.7)	.203 (5.2)	1.50 (38.1)	.220 (5.58) .300 (7.62)	.147 (3.73) .200 (5.08)		MS3339-10	#6 (M3)	—	—	100	1000
MTP6H-E6-C MTP6H-E10-C	6	M, I, S, HS, LH, H	9.59 (243.6)	.62 (15.7)	.203 (5.2)	1.50 (38.1)	.220 (5.58) .300 (7.62)	.147 (3.73) .200 (5.08)		MS3339-11	#6 (M3)	—	—	100	1000

\*Order the number of mounts required in multiples of package quantities.

‡Part Numbers listed are for Standard Materials in Standard Package Quantity. For Bulk package part numbers, see page 137-138.

\*\*Cable Tie Cross Section Sizes: M = Miniature, I = Intermediate, S = Standard, HS = Heavy Standard, LH = Light-Heavy and H = Heavy.

● For use with most common screw types except flat head.

## Right Angle Mounts

Secure wire bundles that run through bulkheads or cabinet holes, holding them away from sharp edges. Can also be used to mount wire bundles adjacent to any surface. Screw or rivet applied.

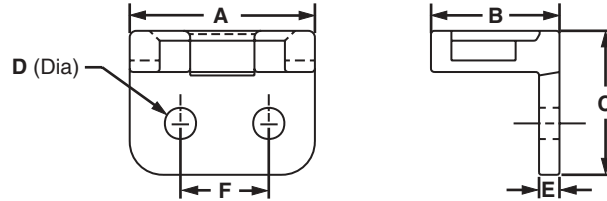

Part Number	Used With Cable Ties**	Dimensions in. (mm)						Color, Material & Where Used	Mil. Std. Part No.	Mounting Method in. (mm)	Packaging*			
		A	B	C	D	E	F				Std. Pkg. Qty.	Std. Ctn. Qty.	Bulk Pkg. Qty.	Bulk Ctn. Qty.
RAMS-S3-M	M, I, S	.56 (14.2)	.39 (9.9)	.44 (11.2)	.095 (2.4)	.06 (1.5)	.281 (7.1)	Natural Nylon 6.6, Indoors	MS3341-2	#3 (M2.5) Screw or 3/32 (2.4) Round Head Rivet	—	—	1000	5000
RAMH-S6-D	M, I, S, HS, LH and H	1.00 (25.4)	.75 (19.1)	1.00 (25.4)	.125 (3.2)	.18 (4.6)	.500 (12.7)		MS3341-1	#6 (M3) Screw or 1/8 (3.2) Round Head Rivet	—	—	500	5000
RAMH-S10-D					.200 (5.1)				—	#10 (M5) Screw or 3/16 (4.7) Round Head Rivet	—	—	500	5000

## Lightening Hole Mounts

Used to secure wire bundles which run through bulkhead lightening holes (.87" (22.1mm) diameter or larger) and keep bundles away from sharp edges. Only one screw or rivet needed.

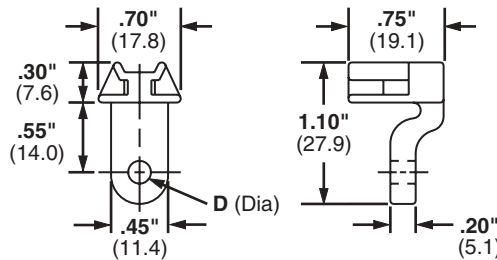

Part Number	Used With Cable Ties**	Dimensions in. (mm)	Color, Material & Where Used	Mil. Std. Part No.	Mounting Method in. (mm)	Packaging*			
		D				Std. Pkg. Qty.	Std. Ctn. Qty.	Bulk Pkg. Qty.*	Bulk Ctn. Qty.
LHMS-S5-D	M, I, S	.127 (3.2)	Natural Nylon 6.6, Indoors	—	#5 (M3) Screw or 1/8 (3.2) Rivet	—	—	500	2500
LHMS-S6-D		.145 (3.7)		MS3340-1	#6 (M3) Screw or 9/64 (3.5) Rivet	—	—	500	2500
LHMS-S10-D		.192 (4.9)		—	#10 (M5) Screw or 3/16 (4.7) Rivet	—	—	500	2500



## Metal Clip-On Mounts



The mount clips on sheet metal edges for fast mounting of harnesses with cable ties. Ties may be inserted from any of the four sides for easy harness orientation.

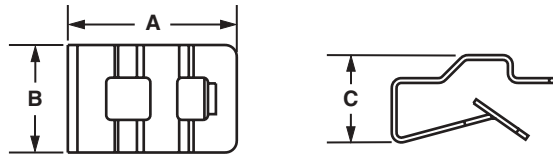

Part Number	Used With Cable Ties**	Dimensions in. (mm)			Max. Panel Thickness	Material	Where Used	Mounting Method	Packaging*			
		A	B	C					Std. Pkg. Qty.	Std. Ctn. Qty.	Bulk Pkg. Qty.	Bulk Ctn. Qty.
MCMS12-P-C	M, I, S	.88 (22.4)	.56 (14.2)	.31 (8.0)	.13 (3.2)	Zinc Plated Steel	Indoors or Outdoors	Clip-On	—	—	100	500
MCMS25-P-C				.46 (11.5)	.24 (6.1)				—	—	100	500
MCMS30-P-C				.55 (14.0)	.27 (6.9)				—	—	100	500

## Metal Mount



Screw applied aluminum mounting base for a secure support in demanding applications.

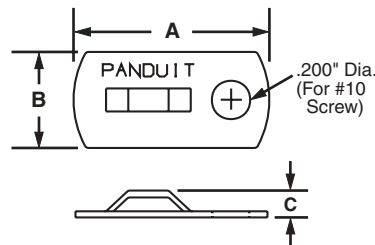

- NOTE: Mount can also be installed with a user supplied adhesive

Part Number‡	Used With Cable Ties**	Dimensions in. (mm)			Material	Where Used	Mounting Method	Max. Static Load lbs. (g)	Packaging*			
		A	B	C					Std. Pkg. Qty.	Std. Ctn. Qty.	Bulk Pkg. Qty.	Bulk Ctn. Qty.
MBMS-S10-C	M, I, S	1.00 (25.4)	.50 (12.7)	.14 (3.6)	Aluminum (Chromate Coated) MIL C. 5541 D Class 3 Coating	Indoors or Outdoors	#10 (M5) Screw	10 (4540)	100	1000	1000	10000



\*Order the number of mounts required in multiples of packaging quantities.

‡Part Numbers listed are for Standard Materials in Standard Package Quantity.

For Bulk package part numbers, see page 137-138.

\*\*Cable Tie Cross Section Sizes: M = Miniature, I = Intermediate and S = Standard.

# PANDUIT® Cable Tie Mounts

## Push Mounts — Winged Push Mounts



Push mounts require no adhesive or additional mounting hardware. They are inserted into pre-drilled holes. The winged base applies pressure on the panel wall to provide a more secure mount in high vibration applications. Can be used where only one side of the panel is accessible.

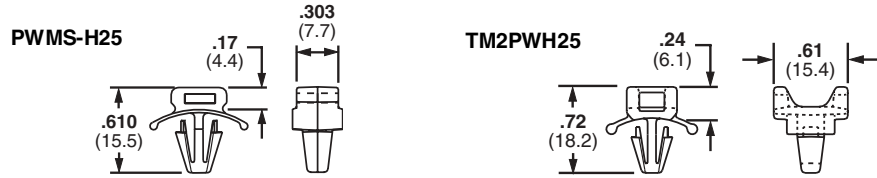

Part Number‡	Used With Cable Ties**	Dimensions in. (mm)	Panel Dimensions in. (mm)		Material	Color	Where Used	Mounting Method	Packaging*			
			Thickness Max.	Hole Diameter					Std. Pkg. Qty.	Std. Ctn. Qty.	Bulk Pkg. Qty.	Bulk Ctn. Qty.
PWMS-H25-C	M, I, S	See Drawing	.105 (2.7)	.250 (6.4)	Nylon 6.6	Natural	Indoors	Inserted into Pre-Drilled Hole	100	1000	1000	5000
PWMS-H25-M0					Weather Resistant Nylon 6.6	Black	Outdoors		—	—	1000	5000
TM2PWH25-C					Nylon 6.6	Natural	Indoors		100	500	1000	5000

Part number shown for PWMS-H25-C and TM2PWH25-C is standard package quantity.

## Push Mounts

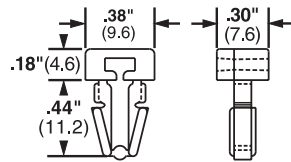

This part is a version of the mount shown above, but without tensioning wings.



Part Number‡	Used With Cable Ties**	Dimensions in. (mm)	Panel Dimensions in. (mm)		Material	Color	Where Used	Mounting Method	Packaging*			
			Thickness Max.	Hole Diameter					Std. Pkg. Qty.	Std. Ctn. Qty.	Bulk Pkg. Qty.	Bulk Ctn. Qty.
PM2H25-C	M, I, S	See Drawing	.125 (3.2)	.250 (6.4)	Nylon 6.6	Natural	Indoors	Inserted into Pre-Drilled Hole	100	500	1000	5000
PM2H25-M0					Weather Resistant Nylon 6.6	Black	Outdoors		—	—	1000	5000
PM2H25-M30					Heat Stabilized Nylon 6.6	Black	Indoors		—	—	1000	5000

Part number shown for PM2H25-C is standard package quantity.

## Push Button Mounts

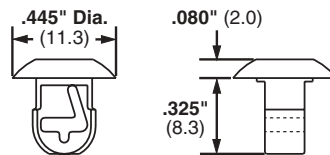

Designed for use where both sides of the panel are accessible.



Part Number‡	Used With Cable Ties**	Dimensions in. (mm)	Panel Dimensions in. (mm)		Material	Color	Where Used	Mounting Method	Packaging*			
			Thickness Max.	Hole Diameter					Std. Pkg. Qty.	Std. Ctn. Qty.	Bulk Pkg. Qty.	Bulk Ctn. Qty.
PBMS-H25-C	M, I, S	See Drawing	.125 (3.2)	.25 (6.4)	Nylon 6.6	Natural	Indoors	Inserted into Pre-Drilled Hole	100	500	1000	5000
PBMS-H25-C14						Gray			100	500	1000	5000
PBMS-H25-M0					Weather Resistant Nylon 6.6	Black	Outdoors		—	—	1000	5000
PBMS-H25-M30					Heat Stabilized Nylon 6.6		Indoors		—	—	1000	5000

Part number shown for PBMS-H25-C and PBMS-H25-C14 is Standard Package Quantity.

## Masonry Push Mounts

Used to secure wire, cable or tubing to masonry surfaces. Installed quickly into pre-drilled holes. Holds bundle securely.

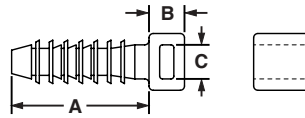

MPMS19-C0  
MPMS25-C0  
MPMH38-L0

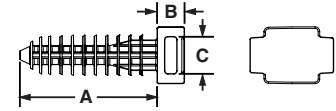

MPMWH32-L0



1. Drill hole using correct size bit.



2. Hammer mount into hole.



3. Place cable tie through mount.



4. Install wires or cable.

Part Number†	Used With Cable Ties**	Dimensions in. (mm)			Hole Dimensions in. (mm)		Material	Color	Where Used	Mounting Method	Packaging*			
		A	B	C	Drill Depth	Hole Diameter					Std. Pkg. Qty.	Std. Ctn. Qty.	Bulk Pkg. Qty.	Bulk Ctn. Qty.
MPMS19-C0	M, I, S	.97 (24.6)	.25 (6.4)	.22 (5.6)	1.25 (31.8)	.188 (5)	Impact Modified Weather-Resistant Nylon 6.6	Black	Outdoors or Indoors	Inserted into Pre-Drilled Hole	100	500	1000	5000
MPMS25-C0						.25 (6)					100	500	1000	5000
MPMH38-L0	M, I, S, HS, LH, H, and HLM ■	1.25 (31.8)	.30 (7.5)	.38 (9.6)	1.50 (38.1)	.375 (10)					50	500	500	5000
MPMWH32-L0		1.41 (35.8)	.28 (7.1)		1.75 (44.5)	.313 (8)					50	500	500	5000

## Wood Push Mount

Used to secure wire, cable, or tubing to wood surfaces. Driven into wood with hammer, barbed design holds mount in place — rated for 60 lb. pullout.

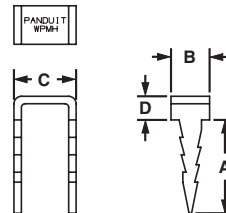

Part Number	Used With Cable Ties**	Dimensions in. (mm)				Material	Where Used	Mounting Method	Packaging*			
		A	B	C	D				Std. Pkg. Qty.	Std. Ctn. Qty.	Bulk Pkg. Qty.	Bulk Ctn. Qty.
WPMH-C	M, I, S, HS, LH, H, and HLM ■	.75 (19.1)	.31 (7.9)	.50 (12.7)	.19 (4.8)	16 gauge steel zinc plated	Outdoors or Indoors	Hammer into Wood	100	500	—	—

\*Order the number of mounts required in multiples of package quantities.

†Part Numbers listed are for Standard Materials in Standard Package Quantity. For Bulk package part numbers, see page 137-138.

■Used with PANDUIT® HLM series Hook & Loop Cable Ties found on page 40.

\*\*Cable Tie Cross Section Sizes: M = Miniature, I = Intermediate, S = Standard, HS = Heavy Standard, LH = Light-Heavy and H = Heavy.

# PANDUIT® Tie Harness Mounts used with Corrugated Loom Tubing

## Tie Harness Mounts



Tie Harness Mounts are designed to be attached to the wire harness during assembly with 2 cable ties. Ties can be installed by hand or, more efficiently, with *PANDUIT® PAT Automatic Cable Tie Tooling* (see page 60). Use with Harness Board Standoff Post (page 129). Available with or without corrugated loom tubing location tab.

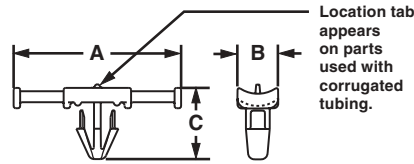

THMSP — Push Barb Style

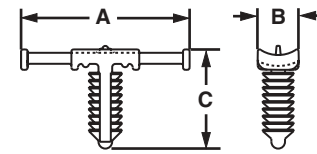

THMSC — Tree Barb Style



**FOR CORRUGATED TUBING** — A specially designed location tab on the mount shelf aligns with grooves in corrugated tubing ensuring proper mount location during assembly.

Part Number‡	Used With Cable Ties**	Dimensions in. (mm)			Panel Dimensions in. (mm)		Material	Color	Where Used	Mounting Method	Packaging*					
		A	B	C	Thickness Max.	Hole Diameter					Std. Pkg. Qty.	Std. Ctn. Qty.	Bulk Pkg. Qty.	Bulk Ctn. Qty.		
THMSP20-C	M, I, S	1.54 (39.1)	.37 (9.5)	.47 (11.9)	.16 (4.1)	.244-.283 (6.2-7.2)	Nylon 6.6	Natural	Indoors	Push Barb	100	1000	—	—		
THMSP20-C30							Heat Stabilized Nylon 6.6	Black	Indoors/ High Temp.		100	1000	—	—		
THMSP25-C				.54 (13.7)	.23 (5.8)		Nylon 6.6	Natural	Indoors		100	1000	1000	5000		
THMSP25-C30				Heat Stabilized Nylon 6.6	Black		Indoors/ High Temp.	100	1000		1000	5000				
THMSC35-C639				.46 (11.7)	.25 (6.4)		.244-.268 (6.2-6.8)	Heat Stabilized Nylon 6	Natural		Indoors/ High Temp.	Tree Barb	100	1000	1000	5000
THMSC35-C630				Black	100		1000	1000	5000							

**FOR DISCRETE WIRING** — There is no location tab for applications not requiring the use of corrugated tubing.

Part Number‡	Used With Cable Ties**	Dimensions in. (mm)			Panel Dimensions in. (mm)		Material	Color	Where Used	Mounting Method	Packaging*					
		A	B	C	Thickness Max.	Hole Diameter					Std. Pkg. Qty.	Std. Ctn. Qty.	Bulk Pkg. Qty.	Bulk Ctn. Qty.		
THMSP20F-C	M, I, S	1.54 (39.1)	.37 (9.5)	.47 (11.9)	.16 (4.1)	.244-.283 (6.2-7.2)	Nylon 6.6	Natural	Indoors	Push Barb	100	1000	—	—		
THMSP20F-C30							Heat Stabilized Nylon 6.6	Black	Indoors/ High Temp.		100	1000	—	—		
THMSP25F-C				.54 (13.7)	.23 (5.8)		Nylon 6.6	Natural	Indoors		100	1000	—	—		
THMSP25F-C30				Heat Stabilized Nylon 6.6	Black		Indoors/ High Temp.	100	1000		1000	5000				
THMSC35F-C639				.46 (11.7)	.25 (6.4)		.244-.268 (6.2-6.8)	Heat Stabilized Nylon 6	Natural		Indoors/ High Temp.	Tree Barb	100	1000	1000	5000
THMSC35F-C630				Black	100		1000	1000	5000							

## THM1SC Tie Harness Mount for Single Cable Tie — Unique Mount is Attached to Harness Automatically as Tie is Installed



- Secured with only 1 cable tie
- Can be used with auto-fed or loose piece cable ties
- Cable ties can be installed by hand with *PANDUIT®* Automatic Cable Tie Tooling Installation Systems (see page 60) or pneumatic tool (page 58) or hand operated cable tie tools (page 56)
- Winged design prevents vibration
- Barb design is easy to insert into pre-drilled hole
- 50 lb. vertical extraction force from .250" hole

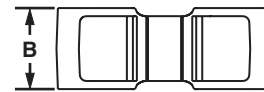
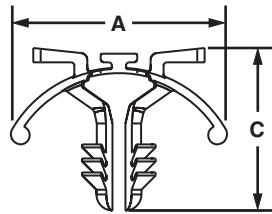

Part Number‡	Used With Cable Ties**	Dimensions in. (mm)			Panel Dimensions in. (mm)		Material	Color	Where Used	Mounting Method	Packaging*			
		A	B	C	Thickness Max.	Hole Diameter					Std. Pkg. Qty.	Std. Ctn. Qty.	Bulk Pkg. Qty.	Bulk Ctn. Qty.
THM1SC-C	M, I, S	.98 (24.8)	.38 (9.5)	.75 (19.1)	.187 (4.7)	.250 (6.5)	Nylon 6.6	Natural	Indoors	Tree Barb	100	1000	1000	5000
THM1SC-C30							Heat Stabilized Nylon 6.6	Black	Indoors/ High Temp.		100	1000	1000	5000

\*Order the number of pieces required in multiples of package quantities.

‡Part Numbers listed are for Standard Materials in Standard Package Quantity. For Bulk package part numbers, see page 137-138.

\*\*Cable Tie Cross Section Sizes: M = Miniature, I = Intermediate and S = Standard.

## Control Panel Mount

Installed behind control panel switch. Ideal for high strain areas where cable is routed from panel door to panel. Compatible with most control panel switch designs.

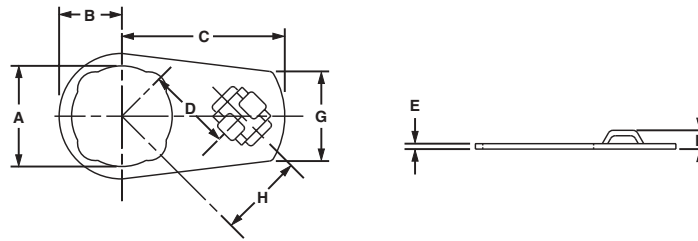

Part Number	Used With Cable Ties**	Dimensions in. (mm)								Material	Mounting Method	Packaging*			
		A	B	C	D	E	F	G	H			Std. Pkg. Qty.	Std. Ctn. Qty.	Bulk Pkg. Qty.	Bulk Ctn. Qty.
CPM87S-C	M, I, S	.89 (22.6)	.57 (14.5)	1.44 (36.6)	.75 (19.1)	.048 (1.2)	.17 (4.3)	.76 (19.3)	.75 (19.1)	Zinc Plated Steel	Control Panel Switch	—	—	100	1000
CPM122S-C		1.22 (31.0)	.75 (19.1)	2.07 (52.6)	1.12 (28.4)			.82 (20.8)	1.12 (28.4)			—	—	100	1000

## PAN-POST™ Standoff

Supports wire bundles above or away from surface.

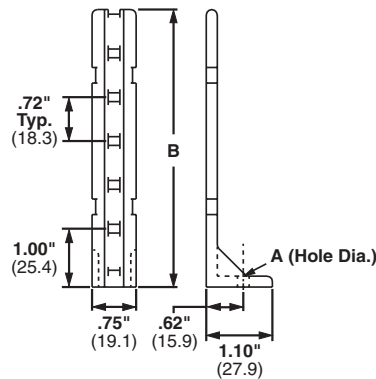

Part Number‡	Used With Cable Ties**	Dimensions in. (mm)		Color & Material	Mounting Method	Packaging*			
		A	B			Std. Pkg. Qty.	Std. Ctn. Qty.	Bulk Pkg. Qty.	Bulk Ctn. Qty.
PP1S-S10-X	M, I, S	.200 (5.1)	2.00 (50.8)	Natural Nylon 6.6	#10 (M5) Screw	10	50	100	1000
PP1S-S12-X		#12 (M5.5) Screw			10	50	100	1000	
PP2S-S10-X		.200 (5.1)	4.60 (116.8)		#10 (M5) Screw	10	50	100	1000
PP2S-S12-X		.228 (5.8)			#12 (M5.5) Screw	10	50	100	1000

## Right Angle Base RAFCB

For use in perpendicular applications. Supports cable above the mount surface.

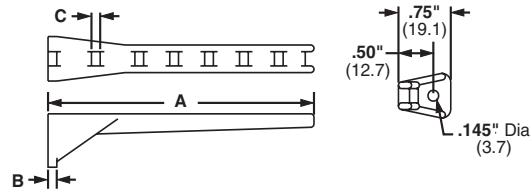

Part Number‡	For Flat Cable Widths (Up to)	A in. (mm)	B in. (mm)	C in. (mm)	Color & Material	Where Used	Mounting Method	Packaging*			
								Std. Pkg. Qty.	Std. Ctn. Qty.	Bulk Pkg. Qty.	Bulk Ctn. Qty.
RAFCB11-S6-C20	1.00 (25.4)	1.75 (44.4)	.125 (3.2)	.125 (3.2)	Black Nylon 6.6	Indoors	#6 (M3) Screw	100	500	1000	5000
RAFCB12-S6-C20	2.00 (50.8)	2.78 (70.6)						100	500	1000	4000
RAFCB13-S6-C20	3.00 (76.2)	3.81 (96.8)						100	500	1000	4000

## Flat Cable Mounting System

Secures stacked cables, folds and breakouts as well as laminated and molded bus bars.



### Base FCB

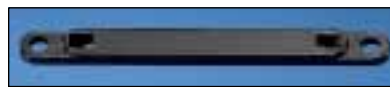
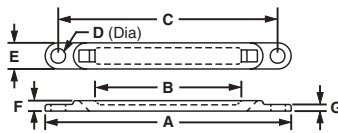

#### Mounting Application

Use one base, one corresponding size

### Plate FCP

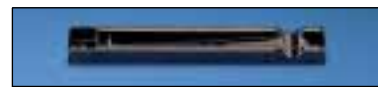
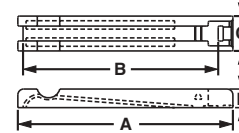

#### Bundling Application

Use two plates (same size) and one intermediate cable tie.



Part Number‡	For Flat Cable Widths (Up to)	Dimensions in. (mm)							Color & Material	Where Used	Mounting Method	Packaging*			
		A	B	C	D	E	F	G				Std. Pkg. Qty.	Std. Ctn. Qty.	Bulk Pkg. Qty.	Bulk Ctn. Qty.
FCB11-S10-C20	1.00 (25.4)	3.29 (83.5)	1.04 (26.4)	2.08 (52.8)	.150 (3.8)	.375 (9.5)	.200 (5.1)	.095 (2.4)	Black Nylon 6.6	Indoors	#10 (M5) Screw	100	1000	1000	5000
FCB12-S10-C20	2.00 (50.8)	3.50 (88.9)	2.04 (51.8)	3.10 (78.7)	.150 (3.8)	.375 (9.5)	.200 (5.1)	.095 (2.4)			#10 (M5) Screw	100	1000	1000	5000
FCB13-S10-C20	3.00 (76.2)	4.52 (114.8)	3.04 (77.2)	4.12 (104.6)	.150 (3.8)	.375 (9.5)	.200 (5.1)	.095 (2.4)			#10 (M5) Screw	100	1000	1000	5000
FCB11-A-C20	1.00 (25.4)	3.29 (83.5)	1.04 (26.4)	2.08 (52.8)	.150 (3.8)	.375 (9.5)	.200 (5.1)	.095 (2.4)	Black Nylon 6.6	Indoors	Adhesive Backed	100	1000	1000	5000
FCB12-A-C20	2.00 (50.8)	3.50 (88.9)	2.04 (51.8)	3.10 (78.7)	.150 (3.8)	.375 (9.5)	.200 (5.1)	.095 (2.4)			Adhesive Backed	100	1000	1000	5000
FCB13-A-C20	3.00 (76.2)	4.52 (114.8)	3.04 (77.2)	4.12 (104.6)	.150 (3.8)	.375 (9.5)	.200 (5.1)	.095 (2.4)			Adhesive Backed	100	1000	1000	5000
FCP11-C20	1.00 (25.4)	1.29 (32.8)	1.04 (26.4)	.375 (9.5)	—	—	.200 (5.1)	—	Black Nylon 6.6	Indoors	Cable Ties	100	1000	1000	5000
FCP12-C20	2.00 (50.8)	2.31 (58.7)	2.04 (51.8)	.375 (9.5)	—	—	.200 (5.1)	—			Cable Ties	100	1000	1000	5000
FCP13-C20	3.00 (76.2)	3.32 (84.3)	3.04 (77.2)	.375 (9.5)	—	—	.200 (5.1)	—			Cable Ties	100	1000	1000	5000

\*Order the number of mounts required in multiples of package quantities.

‡Part Numbers listed are for Standard Materials in Standard Package Quantity. For Bulk package part numbers, see page 137-138.

# PANDUIT® Cable Tie Mounts — Connector Rings

## Closed Connector Rings

Connect multiple wire bundles or hang bundles from conduit, eliminating the need for saddle clamps.

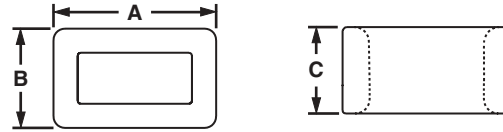
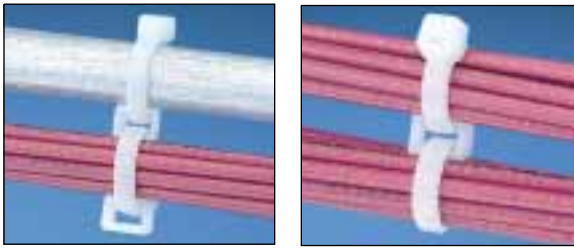

Part Number	Used With Cable Ties**	Dimensions in. (mm)			Material	Color	Where Used	Mounting Method	Packaging*			
		A	B	C					Std. Pkg. Qty.	Std. Ctn. Qty.	Bulk Pkg. Qty.	Bulk Ctn. Qty.
CR2-M	M, I, S	.33 (8.4)	.24 (6.1)	.20 (5.1)	Nylon 6.6	Natural	Indoors	Cable Ties	—	—	1000	10000
CR4H-M	M, I, S, HS, LH	.57 (14.5)	.36 (9.1)	.30 (7.6)	Weather Resistant Nylon 6.6	Black	Indoors/ Outdoors	Cable Ties	—	—	1000	10000
CR4H-M0									—	—	1000	10000

## Open Connector Ring

Designed to “add on” wire bundles without changing cable ties.

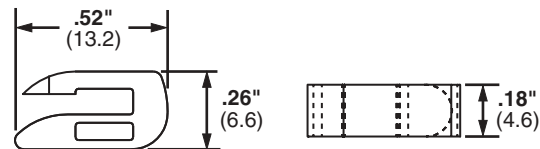

Part Number	Used With Cable Ties**	Dimensions in. (mm)	Material	Color	Where Used	Mounting Method	Packaging*			
							Std. Pkg. Qty.	Std. Ctn. Qty.	Bulk Pkg. Qty.	Bulk Ctn. Qty.
CROS-M	M, I, S	See Drawing	Nylon 6.6	Natural	Indoors	Connects to M, I, S Cable Ties	—	—	1000	5000



## Cable Spacers

Used to separate and/or hang wires, cable and hoses.

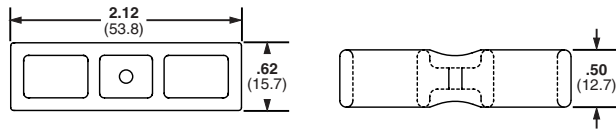
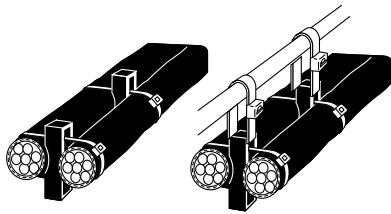

Part Number	Used With Cable Ties**	Dimensions in. (mm)	Material	Color	Where Used	Mounting Method	Packaging*			
							Std. Pkg. Qty.	Std. Ctn. Qty.	Bulk Pkg. Qty.	Bulk Ctn. Qty.
CSH-D20	M, I, S, HS, LH, H	See Drawing	Nylon 6.6	Black	Indoors	Cable Ties	—	—	500	2500
CSH-D0			Weather Resistant Nylon 6.6		Outdoors or Indoors		—	—	500	2500

## Cable Spacer — Cross

Connects two bundles at 90°. Provides .19" (4.8mm) space between bundles. Dual cradle design. Recommended max. bundle diameter (each) is .625" (15.9mm).

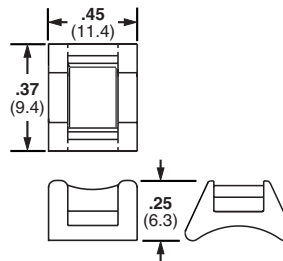

Part Number	Used With Cable Ties**	Dimensions in. (mm)	Material	Color	Where Used	Mounting Method	Packaging*			
							Std. Pkg. Qty.	Std. Ctn. Qty.	Bulk Pkg. Qty.	Bulk Ctn. Qty.
CSCS-M	M, I, S	See Drawing	Nylon 6.6	Natural	Indoors	Cable Ties	—	—	1000	10000

## Marking Pens

Provide fast drying, permanent, legible identification on nylon — where ordinary marking pens will not work.

PX-0  
PX-2



PX-10



PFX-0  
PFX-2



Part Number	Tip	Color	Description	Std. Pkg. Qty.*	Std. Ctn. Qty.
PX-0	Regular	Black	Color of ink is color of pen. Reversible tip to extend life of pen.	12	144
PX-2	Regular	Red		12	144
PX-10	Regular	White	For marking black or other dark-colored parts. Color of tip denotes color.	12	300
PFX-0	Fine	Black	For detailed marking on nylon surfaces. Color of cap and tip is color of ink.	12	144
PFX-2	Fine	Red		12	144

\*Order the number of pieces required in multiples of packaging quantities.

\*\*Cable Tie Cross Section Sizes: M = Miniature, I = Intermediate, S = Standard, HS = Heavy Standard, LH = Light-Heavy and H = Heavy.

## Marker Plates



PANDUIT® Marker Plates can be mounted in any direction, either vertically or horizontally as flags, tags, or wrap-around identification plates. They can be marked with nylon marking pens or hot stamped. See page 105 for marker pen information.

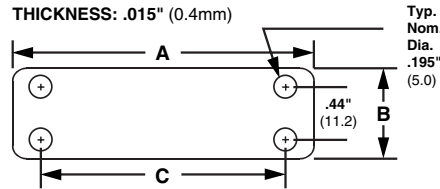

Part Number‡	Used With Cable Ties	Dimensions in. (mm)			Material	Color	Where Used	Mounting Method	Packaging*			
		A	B	C					Std. Pkg. Qty.	Std. Ctn. Qty.	Bulk Pkg. Qty.	Bulk Ctn. Qty.
MP150-C	M, I, S	1.50 (38.1)	.75 (19.0)	1.03 (26.2)	Nylon 6.6	White	Indoors	Cable Ties	100	500	1000	5000
MP175-C		1.75 (44.5)	.75 (19.0)	1.28 (32.5)					100	500	1000	5000
MP200-C		2.00 (50.8)	.75 (19.0)	1.53 (38.4)					100	500	1000	5000
MP250-C		2.50 (63.5)	.75 (19.0)	2.03 (51.6)					100	500	1000	5000
MP350-C		3.50 (88.9)	.75 (19.0)	3.03 (77.0)					100	500	1000	5000
MP250W175-C		2.50 (63.5)	1.75 (44.5)	2.03 (51.6)					100	500	1000	5000
MP150-C0	M, I, S	1.50 (38.1)	.75 (19.0)	1.03 (26.2)	Weather Resistant Nylon 6.6	Black	Outdoors	Weather Resistant Cable Ties	100	500	1000	5000
MP175-C0		1.75 (44.5)	.75 (19.0)	1.28 (32.5)					100	500	1000	5000
MP200-C0		2.00 (50.8)	.75 (19.0)	1.53 (38.4)					100	500	1000	5000
MP250-C0		2.50 (63.5)	.75 (19.0)	2.03 (51.6)					100	500	1000	5000
MP350-C0		3.50 (88.9)	.75 (19.0)	3.03 (77.0)					100	500	1000	5000

## Marker Plates on Rolls

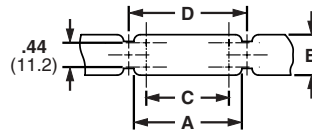

Part Number	Used With Cable Ties	Dimensions in. (mm)				Material	Color	Where Used	Mounting Method	Packaging*			
		A	B	C	D					Std. Pkg. Qty.	Std. Ctn. Qty.	Bulk Pkg. Qty.	Bulk Ctn. Qty.
MP150-R	M, I, S	1.50 (38.1)	.75 (19.0)	1.03 (26.2)	1.69 (42.9)	Nylon 6.6	White	Indoors	Cable Ties	—	—	1000	5000
MP175-R		1.75 (44.5)	.75 (19.0)	1.28 (32.5)	1.94 (49.3)					—	—	1000	5000
MP200-R		2.00 (50.8)	.75 (19.0)	1.53 (38.9)	2.19 (55.6)					—	—	1000	5000
MP250-R		2.50 (63.5)	.75 (19.0)	2.03 (51.6)	2.69 (68.3)					—	—	1000	5000

## Marker Plate Kits

Part Number	Description	Std. Pkg. Qty.*
MP150KIT-Q	Kit contains 25 MP150 marker plates, 1 PFX-0 marking pen.	1
MP250KIT-Q	Kit contains 25 MP250 marker plates, 1 PFX-0 marking pen.	1
MP350KIT-Q	Kit contains 25 MP350 marker plates, 1 PFX-0 marking pen.	1

## Stackable Cable Spacer

Just one part to inventory. Each spacer snaps by hand into another— increases spacer height by 1/2" increments. Because there is only one part, on-site sorting is eliminated. Can be used with up to 3/4" width lashed cable supports in parallel or perpendicular applications.

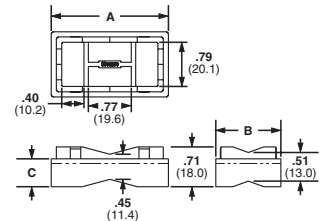
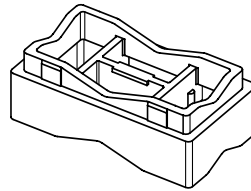

Used perpendicular to strand and cable



Used parallel to strand and cable



Underground application

Part Number	Used With Cable Ties	Dimensions in. (mm)			Material	Color	Where Used	Mounting Method	Packaging*			
		A	B	C					Std. Pkg. Qty.	Std. Ctn. Qty.	Bulk Pkg. Qty.	Bulk Ctn. Qty.
SACS50-T100	See Footnote	2.08 (52.8)	1.16 (29.5)	.50 (12.7)	Weather Resistant Polypropylene	Black	Outdoors	Cable Ties	—	—	200	2000

Stackable Spacers may be installed using Weather-Resistant Lashing Ties (see page 15), Weather-Resistant Extra-Heavy and Light-Heavy Cable Ties (see page 15), and Stainless Steel Ties (see page 77).

## Weather Resistant Polypropylene Aerial Support Tie — With integral 1/2" (12.7mm) spacer

Designed to attach coax or telephone cable to the support strand 1/4" (6.4mm) or 5/16" (7.9mm) to form the expansion loop and keep equipment and cables clear of pole hardware. One-piece construction with integral spacer reduces inventory costs of separate spacer and bands and installs faster to lower the installed cost. Releasable and reusable.

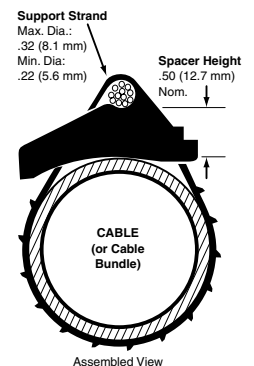
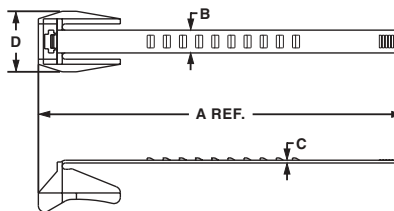

Part Number	Length A in. (mm)	Width B in. (mm)	Thickness C in. (mm)	Head Width D in. (mm)	Max. Bundle Dia. in. (mm)	Min. Loop Tensile Strength lbs. (N)	Recommended PANDUIT® Installation Tool Part Number	Packaging*	
AST10-5-C100	5.6 (142)	.448 (11.4)	.055 (1.4)	1.16 (29.5)	1.0 (25)	75 (334)	Hand Installed Only	100	1000
AST15-5-C100	6.9 (175)				1.5 (38)			100	1000
AST20-5-C100	8.4 (214)				2.0 (51)			100	1000
AST25-5-C100	10.0 (254)				2.5 (64)			100	1000

\*Order the number of pieces required in multiples of package quantities.

## Cable and Wire Mounting Devices (used without cable ties)



Wiring Accessories are an integral part of the *PANDUIT®* comprehensive selection of wire management products.

These accessories are one piece solutions that help provide the lowest installed cost for controlling, mounting and protecting wire and cable.

Mounting methods include:

- Adhesive-Backed
- Screw applied
- Rivet applied
- Push Mounts

## Adhesive Backed Mounting Devices

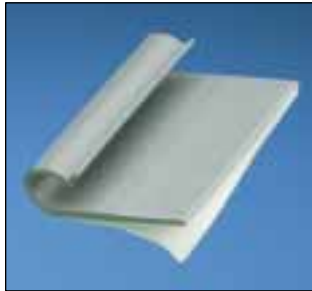

### Faster Liner Removal Speeds Installation and Lowers Installed Cost

- The adhesive backed mounts are offered either as one or two mounts per liner
- The two-up mounts are easily removed by bending the mounts away from the liner
- The individual mounts have a convenient tear tab for quick removal

## CLINCHER™ Adjustable Releasable Clamp



This clamp provides a fast and convenient method of securing bundles from .19" (4.8mm) up to .69" (17.5mm) diameter. It is available with adhesive backing or screw applied with one #6 (M3) screw.

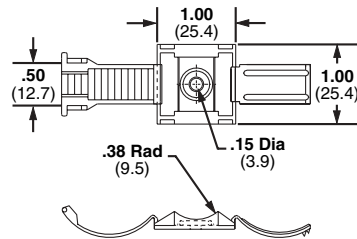

The *CLINCHER™* clamp is fast and easy to use. . .

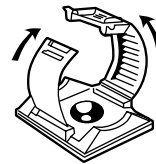

Lift tab to release

Part Number‡	Bundle Dia. in. (mm)	Material	Color	Where Used	Mounting Method	Max. Static Load lbs. (g)	Packaging*				
							Std. Pkg. Qty.	Std. Ctn. Qty.	Bulk Pkg. Qty.	Bulk Ctn. Qty.	
ARC.68-A-Q	.19-.69 (4.8-17.5)	Polypropylene	White	Indoors	Rubber Adhesive	.50 (227)	25	250	100	1000	
ARC.68-A-Q14			Gray				25	250	100	1000	
ARC.68-S6-Q			White		#6 (M3) Pan Head Screw		—	25	250	100	1000
ARC.68-S6-Q14			Gray				—	25	250	100	1000



## Adhesive Backed Cord Clips — ACC Type



Three sizes of clips to hold cords, tubing, cable, or wire bundles up to .62" (15.7mm) diameter. Bundles are easily snapped into or out of the clips.

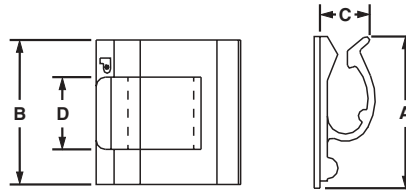

Part Number‡	Max. Bundle Dia. in. (mm)	Dimensions in. (mm)				Material	Color	Where Used	Adhesive Type	Max. Static Load lbs. (g)	Packaging*			
		A	B	C	D						Std. Pkg. Qty.	Std. Ctn. Qty.	Bulk Pkg. Qty.	Bulk Ctn. Qty.
ACC19-A-C	.19 (4.8)	.62 (15.9)	.76 (19.3)	.25 (6.5)	.39 (9.9)	Nylon 6.6	Natural	Indoors	Rubber	.20 (91)	100	500	1000	5000
ACC19-AT-C						Nylon 6.6	Natural	Indoors/ High Temp.	Acrylic		100	500	1000	5000
ACC19-A-C20						Nylon 6.6	Black	Indoors	Rubber		100	500	1000	5000
ACC19-AT-C0						Weather Resistant Nylon 6.6	Black	Outdoors/ High Temp.	Acrylic		100	500	1000	5000
ACC38-A-C	.38 (9.6)	1.00 (25.4)	1.00 (25.4)	.27 (6.9)	.49 (12.4)	Nylon 6.6	Natural	Indoors	Rubber	.50 (227)	100	500	1000	5000
ACC38-AT-C						Nylon 6.6	Natural	Indoors/ High Temp.	Acrylic		100	500	1000	5000
ACC38-A-C20						Nylon 6.6	Black	Indoors	Rubber		100	500	1000	5000
ACC38-AT-C0						Weather Resistant Nylon 6.6	Black	Outdoors/ High Temp.	Acrylic		100	500	1000	5000
ACC62-A-C	.62 (15.7)	1.24 (31.4)	1.12 (28.6)	.63 (16.1)	.74 (18.8)	Nylon 6.6	Natural	Indoors	Rubber	.70 (318)	100	500	500	5000
ACC62-AT-C						Nylon 6.6	Natural	Indoors/ High Temp.	Acrylic		100	500	500	5000
ACC62-A-C20						Nylon 6.6	Black	Indoors	Rubber		100	500	500	5000
ACC62-AT-C0						Weather Resistant Nylon 6.6	Black	Outdoors/ High Temp.	Acrylic		100	500	500	5000

## Push Mount Cord Clip



Mounts snap easily into pre-drilled holes. Integral mounting device eliminates the need for additional mounting hardware. The winged design holds mount in place in applications where vibration is present.

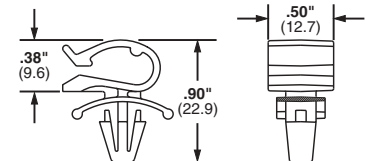

Part Number	Max. Bundle Dia. in. (mm)	Dimensions	Material	Color	Where Used	Panel Dimensions in. (mm)		Mounting Method	Packaging*			
						Max. Thickness	Hole Diameter		Std. Pkg. Qty.	Std. Ctn. Qty.	Bulk Pkg. Qty.	Bulk Ctn. Qty.
PMCC38H25-C	.38 (9.6)	See drawing	Nylon	Natural	Indoors	.105 (2.7)	.250 (6.4)	Inserted into a Pre-Drilled Hole	100	1000	1000	5000
PMCC38H25-M0			Weather Resistant Nylon 6.6	Black	Outdoors				—	—	1000	5000

\*Order the number of mounts required in multiples of packaging quantities.  
‡Part Numbers listed are for Standard Materials in Standard Package Quantity.  
For Bulk package part numbers, see page 137-138.

# PANDUIT® Cable and Wire Mounting Devices

## AJC Type

These low profile “J” clips retain cords, wires, or tubing and are available in four sizes. Their flexible design allows for easy cord insertion yet holds bundles tightly.

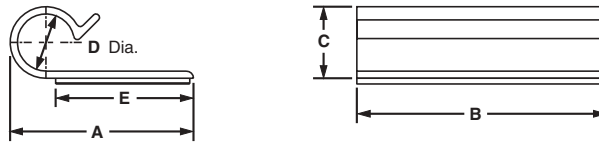
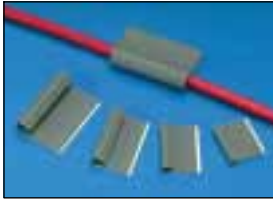

Part Number	Max. Bundle Dia. in. (mm)	Dimensions in. (mm)					Color & Material	Where Used	Mounting Method	Max. Static Load lbs. (g)	Packaging*			
		A	B	C	D	E					Std. Pkg. Qty.	Std. Ctn. Qty.	Bulk Pkg. Qty.	Bulk Ctn. Qty.
AJC19-A-C	.19 (4.8)	.89 (22.6)	1.25 (31.8)	.30 (7.6)	.19 (4.8)	.77 (19.6)	Gray, PVC	Indoors	Rubber Adhesive	.50 (227)	—	—	100	1000
AJC25-A-C	.25 (6.4)	.92 (23.4)	1.50 (38.1)	.34 (8.6)	.25 (5.8)	.77 (19.6)				.60 (272)	—	—	100	1000
AJC31-A-C	.31 (7.9)	1.23 (31.2)	1.75 (44.5)	.44 (11.2)	.31 (7.9)	1.03 (26.2)				.90 (408)	—	—	100	1000
AJC38-A-C	.38 (9.6)	1.28 (32.5)	2.00 (50.8)	.53 (13.5)	.38 (10.2)	1.03 (26.2)				1.0 (454)	—	—	100	1000

## A1C Type

Holds cords, cables and tubing. Single adhesive pad for confined areas.

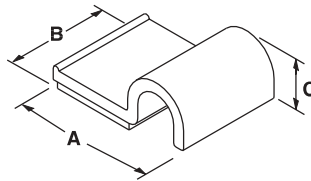
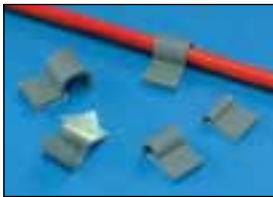

Part Number	Max. Bundle Dia. in. (mm)	Dimensions in. (mm)			Material	Color	Where Used	Mounting Method	Max. Static Load lbs. (g)	Packaging*			
		A	B	C						Std. Pkg. Qty.	Std. Ctn. Qty.	Bulk Pkg. Qty.	Bulk Ctn. Qty.
A1C12-A-C8	.12 (3.0)	.77 (19.6)	.63 (16)	.23 (5.8)	PVC	Gray	Indoors	Rubber Adhesive	.14 (64)	—	—	100	1000
A1C25-A-C8	.25 (6.4)	.91 (23.1)	.63 (16)	.38 (9.7)						—	—	100	1000
A1C38-A-C8	.38 (9.5)	1.04 (26.4)	.63 (16)	.51 (13)						—	—	100	1000
A1C50-A-C8	.50 (12.7)	1.17 (29.7)	.63 (16)	.64 (16.3)						—	—	100	1000

## A2C Type

Holds cords, cables and tubing. Two adhesive pads for added strength.

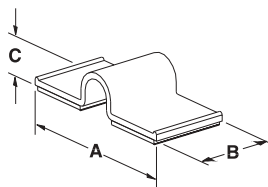

Part Number	Max. Bundle Dia. in. (mm)	Dimensions in. (mm)			Material	Color	Where Used	Mounting Method	Max. Static Load lbs. (g)	Packaging*			
		A	B	C						Std. Pkg. Qty.	Std. Ctn. Qty.	Bulk Pkg. Qty.	Bulk Ctn. Qty.
A2C12-A-C8	.12 (3.0)	1.30 (33)	.63 (16)	.23 (5.8)	PVC	Gray	Indoors	Rubber Adhesive	.37 (169)	—	—	100	1000
A2C25-A-C8	.25 (6.4)	1.43 (36.3)	.63 (16)	.36 (9.1)						—	—	100	1000
A2C38-A-C8	.38 (9.5)	1.56 (39.6)	.63 (16)	.49 (12.4)						—	—	100	1000
A2C50-A-C8	.50 (12.7)	1.72 (43.7)	.63 (16)	.61 (15.5)						—	—	100	1000

# PANDUIT® Cable and Wire Mounting Devices

## MACC Type

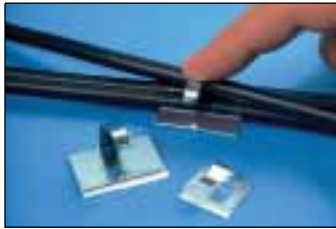

Metal adhesive backed cord clip can be opened and closed without damage to the clip, to remove or add wires quickly and easily.

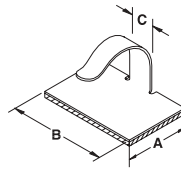

Part Number	Max. Bundle Dia. in. (mm)	Dimensions in. (mm)			Material	Color	Where Used	Mounting Method	Max. Static Load lbs. (g)	Packaging*			
		A	B	C						Std. Pkg. Qty.	Std. Ctn. Qty.	Bulk Pkg. Qty.	Bulk Ctn. Qty.
MACC25-A-C	.25 (6.4)	.53 (13.5)	.79 (20)	.28 (7.1)	Zinc Plated Steel	—	Indoors	Rubber Adhesive	.21 (95)	100	1000	—	—
MACC62-A-C	.62 (15.7)	.75 (19.1)	1.18 (30)	.28 (7.1)					.44 (200)	100	1000	—	—

## LWC Type



Holds wires, cable and tubing and is available in 6 sizes, with releasable latch. Adhesive backed and push mount styles available. Large mounting base for high bonding strength.

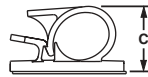
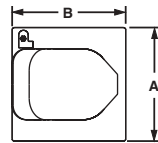

Adhesive Version

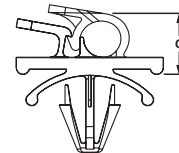

Push Mount Version



Part Number‡	Max. Bundle Dia. in. (mm)	Dimensions in. (mm)			Material	Color	Where Used	Panel Thickness in. (mm)		Mounting Method	Max. Static Load lbs. (g)	Packaging*																				
		A	B	C				Max. Thickness	Hole Diameter			Std. Pkg. Qty.	Std. Ctn. Qty.	Bulk Pkg. Qty.	Bulk Ctn. Qty.																	
LWC19-A-C	.19 (4.8)	.61 (15.5)	.85 (21.6)	.39 (9.9)	Nylon 6.6	Indoors	—	—	Rubber Adhesive	.25 (113)	100	1000	—	—																		
LWC19-A-C14											100	1000	500	5000																		
LWC19-A-C20											100	1000	—	—																		
LWC25-A-C	.25 (6.4)	1.0 (25.4)	.88 (22.2)	.45 (11.4)							Nylon 6.6	Indoors	—	—	.45 (204)	100	1000	500	5000													
LWC25-A-C14																100	1000	500	5000													
LWC25-A-C20																100	1000	—	—													
LWC38-A-C	.37 (9.5)	1.0 (25.4)	1.0 (25.4)	.56 (14.2)												Nylon 6.6	Indoors	—	—	.50 (227)	100	1000	500	5000								
LWC38-A-C14																					100	1000	500	5000								
LWC38-A-C20																					100	1000	—	—								
LWC50-A-L	.50 (12.7)	1.0 (25.4)	1.26 (32.0)	.67 (17.0)																	Nylon 6.6	Indoors	—	—	.63 (284)	50	500	200	2000			
LWC50-A-L14																										50	500	200	2000			
LWC50-A-L20																										50	500	—	—			
LWC75-A-L	.75 (19.1)	1.24 (31.5)	1.48 (37.6)	.90 (22.9)	Nylon 6.6	Indoors	—	—	.94 (425)	50																500	100	1000				
LWC75-A-L14										50																500	100	1000				
LWC75-A-L20										50																500	—	—				
LWC100-A-L	1.0 (25.4)	1.97 (50.0)	2.21 (56.1)	1.26 (32.0)						Nylon 6.6	Indoors	—	—	2.25 (1020)	50											500	100	1000				
LWC100-A-L14															50											500	100	1000				
LWC100-A-L20															50											500	—	—				
LWC19-H25-C	.19 (4.8)	.51 (12.8)	.85 (21.6)	.41 (10.4)											Nylon 6.6	Indoors	.102 (2.6)	.220 (5.6)	Inserted into Pre-Drilled Hole	—						100	1000	500	5000			
LWC19-H25-C14																										100	1000	500	5000			
LWC19-H25-C20																										100	1000	—	—			
LWC25-H25-C	.25 (6.4)	.58 (14.7)	.86 (21.8)	.47 (11.9)																	Nylon 6.6	Indoors	.102 (2.6)	.220 (5.6)	Inserted into Pre-Drilled Hole	—	100	1000	500	5000		
LWC25-H25-C14																											100	1000	500	5000		
LWC25-H25-C20																											100	1000	—	—		
LWC38-H25-C	.37 (9.5)	.58 (14.7)	.94 (23.9)	.57 (14.5)	Nylon 6.6	Indoors	.102 (2.6)	.220 (5.6)	Inserted into Pre-Drilled Hole																		—	100	1000	500	5000	
LWC38-H25-C14																												100	1000	500	5000	
LWC38-H25-C20																												100	1000	—	—	
LWC50-H25-L	.50 (12.7)	.76 (19.3)	1.25 (31.8)	.78 (19.8)						Nylon 6.6	Indoors	.102 (2.6)	.220 (5.6)	Inserted into Pre-Drilled Hole														—	50	500	200	2000
LWC50-H25-L14																													50	500	200	2000
LWC50-H25-L20																													50	500	—	—
LWC75-H25-L	.75 (19.1)	.87 (22.1)	1.45 (36.8)	.97 (24.7)											Nylon 6.6	Indoors	.102 (2.6)	.220 (5.6)	Inserted into Pre-Drilled Hole	—									50	500	100	1000
LWC75-H25-L14																													50	500	100	1000
LWC75-H25-L20																													50	500	—	—
LWC100-H25-L	1.0 (25.4)	.99 (25.1)	1.89 (47.9)	1.30 (33.0)																	Nylon 6.6	Indoors	.102 (2.6)	.220 (5.6)	Inserted into Pre-Drilled Hole	—			50	500	100	1000
LWC100-H25-L14																													50	500	100	1000
LWC100-H25-L20																													50	500	—	—

\*Order the number of mounts required in multiples of package quantities.

‡Part numbers listed are for standard materials in standard package quantity. For Bulk package part numbers, see page 137-138.

## BEC Type

Bevel Entry Clips are available in 3 sizes to hold tubing, cable or wire bundles. The beveled entry makes it easy to snap in the bundle. The clips are available in push barb or adhesive backed styles.

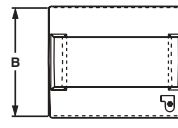
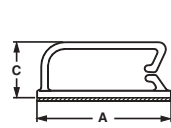

Adhesive Version

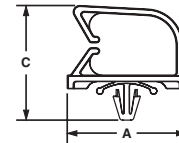

Push Mount Version



Part Number‡	Max. Bundle Dia. in. (mm)	Dimensions in. (mm)			Material	Color	Where Used	Panel Dimensions in. (mm)		Mounting Method in. (mm)	Max. Static Load lbs. (g)	Packaging*			
		A	B	C				Max. Thickness	Hole Diameter			Std. Pkg. Qty.	Std. Ctn. Qty.	Bulk Pkg. Qty.	Bulk Ctn. Qty.
BEC38-A-L	.38 (9.6)	1.46 (37.1)	1.24 (31.5)	.52 (13.2)	Nylon 6.6	Natural	Indoors	—	—	Rubber Adhesive	.91 (411)	50	500	200	1000
BEC38-A-L20					Nylon 6.6	Black	Indoors	—	—	Rubber Adhesive		50	500	200	1000
BEC38-AT-L0					Weather Resist. Nylon 6.6	Black	Outdoors	—	—	Acrylic Adhesive		50	500	200	1000
BEC62-A-L	.62 (15.7)	1.46 (37.1)	1.24 (31.5)	.79 (20.1)	Nylon 6.6	Natural	Indoors	—	—	Rubber Adhesive	.91 (411)	50	500	200	1000
BEC62-A-L20					Nylon 6.6	Black	Indoors	—	—	Rubber Adhesive		50	500	200	1000
BEC62-AT-L0					Weather Resist. Nylon 6.6	Black	Outdoors	—	—	Acrylic Adhesive		50	500	200	1000
BEC75-A-L	.75 (19)	1.46 (37.1)	1.49 (37.8)	.89 (22.6)	Nylon 6.6	Natural	Indoors	—	—	Rubber Adhesive	1.09 (493)	50	500	200	1000
BEC75-A-L20					Nylon 6.6	Black	Indoors	—	—	Rubber Adhesive		50	500	200	1000
BEC75-AT-L0					Weather Resist. Nylon 6.6	Black	Outdoors	—	—	Acrylic Adhesive		50	500	200	1000
BCECP38H25-L	.38 (9.6)	1.46 (37.1)	.73 (18.5)	1.0 (25.4)	Nylon 6.6	Natural	Indoors	.08 (1.9)	.250 (6.4)	Inserted into Pre-Drilled Hole	—	50	500	200	1000
BCECP38H25-L20						Black						50	500	200	1000
BCECP75H25-L	.75 (9.6)	1.47 (37.3)	.73 (18.5)	1.35 (34.3)		Natural						50	500	200	1000
BCECP75H25-L20						Black						50	500	200	1000

## ADCC Type

Holds two cables in high temperature applications both indoors and outdoors.

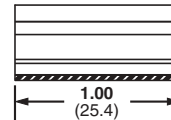
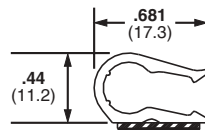

Part Number‡	Max. Bundle Dia. in. (mm)	Material	Color	Where Used	Mounting Method	Max. Static Load lbs. (g)	Packaging*	
							Std. Pkg. Qty.	Std. Ctn. Qty.
ADCC31-AT-C10	2 bundles .20-.31 (5.1-7.9)	NORYL*	White	Indoors/ Outdoors	Acrylic Adhesive	.25 (113)	100	500

\*NORYL is a registered trademark of General Electric Company.

## AMC Type

Holds a single cable and can be mounted on any flat smooth surface both indoors and outdoors.

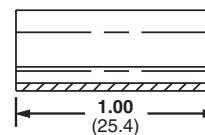
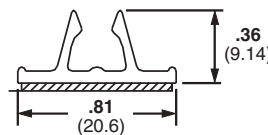

Part Number	Max. Bundle Dia. in. (mm)	Material	Color	Where Used	Mounting Method	Max. Static Load lbs. (g)	Packaging*			
							Std. Pkg. Qty.	Std. Ctn. Qty.	Bulk Pkg. Qty.	Bulk Ctn. Qty.
AMC25-AT-C10	.22-.28 (6-7)	PVC	White	Indoors/ Outdoors	Acrylic Adhesive	.40 (182)	—	—	1000	1000

\*Order the number of mounts required in multiples of package quantities.

‡Part numbers listed are for standard materials in standard package quantity. For Bulk package part numbers, see page 137-138.



# PANDUIT® Cable and Wire Mounting Devices

## VCC Type



Funnel entry design of this vertical cord clip allows for easy insertion of wires, cables and cords. Top loading for fast production operations.

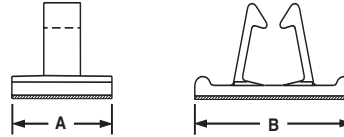

Part Number‡	Max. Bundle Dia. in. (mm)	Dimensions in. (mm)		Material	Color	Where Used	Mounting Method	Max. Static Load lbs. (g)	Packaging*			
		A	B						Std. Pkg. Qty.	Std. Ctn. Qty.	Bulk Pkg. Qty.	Bulk Ctn. Qty.
VCC25-A-C	.25 (6.4)	.50 (12.7)	1.00 (25.4)	Nylon 6.6	Natural	Indoors	Rubber Adhesive	.25 (113)	100	500	1000	5000
VCC25-A-C20					Black			100	500	1000	5000	
VCC50-A-C	.50 (12.7)	1.00 (25.4)	1.56 (39.7)		Natural			100	500	200	1000	

## Latching Clip



This versatile clip retains and supports wire for a variety of applications. Provides a quickly installed mount with a locked cover which withstands vibration yet allows easy access.

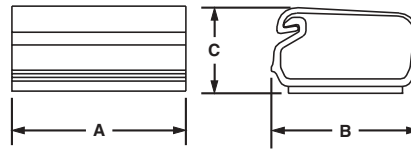

Part Number	Max. Bundle Dia. in. (mm)	Dimensions in. (mm)			Material	Color	Where Used	Mounting Method	Max. Static Load lbs. (g)	Packaging*			
		A	B	C						Std. Pkg. Qty.	Std. Ctn. Qty.	Bulk Pkg. Qty.	Bulk Ctn. Qty.
LC3-A-C8	.20 (5.0)	.75 (19)	.78 (19.8)	.47 (11.9)	PVC	Gray	Indoors	Rubber Adhesive	.22 (100)	—	—	100	1000
LC5-A-C8	.36 (9.1)	1.00 (25.4)	1.01 (25.7)	.61 (15.5)					.44 (200)	—	—	100	1000
LC10-A-L8	.93 (23.6)	1.00 (25.4)	1.51 (38.4)	.84 (21.3)					.60 (272)	—	—	50	500

## Cable Holder



Holds wires, cables and tubing and has a releasable latch. Adhesive backed and screw mount styles available. Large mounting base for high bonding strength.

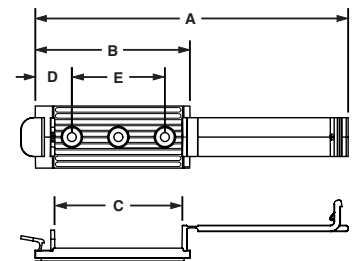

Part Number	Cable Width in. (mm)	Dimensions in. (mm)					Material	Color	Where Used	Mounting Method	Max. Static Load lbs. (g)	Packaging*	
		A	B	C	D	E						Std. Pkg. Qty.	Std. Ctn. Qty.
CH105-A-C14	2.00 (50.8)	5.04 (128.0)	2.48 (63.0)	2.06 (52.3)	.59 (15.0)	1.50 (38.1)	Nylon 6.6	Gray	Indoors	Rubber Adhesive	1.28 (582)	100	200
CH105-S6-C14										(2) #6 (M3) Screws			

\*Order the number of mounts required in multiples of package quantities.

‡Part numbers listed are standard materials in standard package quantity. For Bulk package part numbers, see page 137-138.

# PANDUIT® Cable and Wire Mounting Devices

## Adhesive Backed Flat Cable Mounts LPFCM Type — Low Profile



This low profile mount is available in 3 sizes and provides cost effective cable containment and identification for stack heights up to .105" (2.67mm). It features a matte, textured surface for either hand written identification or application of computer labels.

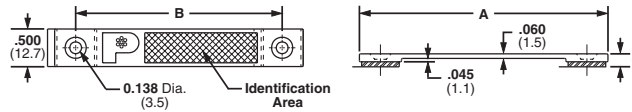

Part Number‡	Cable Width in. (mm)	Dimensions in. (mm)				Material	Color	Where Used	Mounting Method	Packaging*			
		A	B	C	D					Std. Pkg. Qty.	Std. Ctn. Qty.	Bulk Pkg. Qty.	Bulk Ctn. Qty.
LPFCM14-A-C14	1.44 (37)	2.56 (65)	2.00 (50.8)	.134 (3.4)	2.00 (50.8)	Nylon 6.6	Gray	Indoors	Rubber Adhesive/ Static Load .25 lbs (113g) or (2) #6 (M3) Screws	100	500	500	5000
LPFCM22-A-C14	2.19 (56)	3.31 (84)	2.75 (69.9)		2.75 (69.9)					100	500	500	5000
LPFCM34-A-C14	3.44 (87)	4.56 (115.8)	4.00 (101.6)		4.00 (101.6)					100	500	500	5000

## Adhesive Backed Flat Cable Mounts — FCM Type



The FCM will hold flat cable securely without damaging the cable's jacket or conductors. The four available sizes will accommodate cable up to 3.25" wide and allow cable stacking up to .17" (4.3mm). All sizes are available with or without adhesive backing.

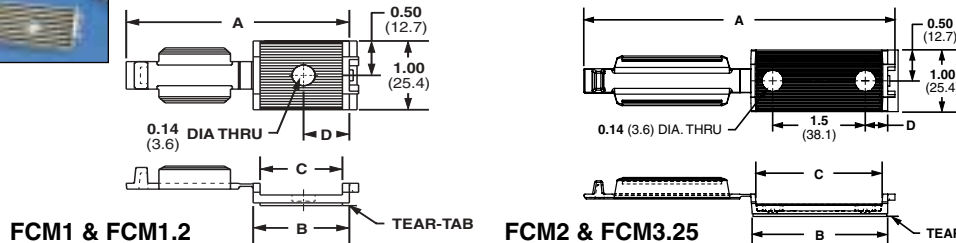

Part Number‡	Cable Width in. (mm)	Dimensions in. (mm)				Material	Color	Where Used	Mounting Method	Packaging*			
		A	B	C	D					Std. Pkg. Qty.	Std. Ctn. Qty.	Bulk Pkg. Qty.	Bulk Ctn. Qty.
<b>ADHESIVE BACKED</b> FCM1-A-C14	1.00 (25.4)	2.90 (73.7)	1.21 (30.7)	1.05 (26.7)	.61 (15.5)	Nylon 6.6	Gray	Indoors	Rubber Adhesive/ Static Load .5 lbs. (227g)	100	500	200	1000
FCM1.2-A-C14	1.20 (30.5)	3.16 (80.3)	1.37 (34.8)	1.20 (30.5)	.69 (17.5)				Rubber Adhesive/ Static Load .62 lbs. (281g)	100	500	200	1000
FCM2-A-C14	2.00 (50.8)	5.06 (128.5)	2.22 (56.4)	2.05 (52.1)	.37 (9.4)				Rubber Adhesive/ Static Load 1.0 lbs. (454g)	100	500	200	1000
FCM3.25-A-L14	3.25 (82.5)	7.30 (185.4)	3.38 (85.9)	3.23 (82.0)	.94 (23.9)				Rubber Adhesive/ Static Load 1.5 lbs. (681g)	50	500	200	1000

### SCREW MOUNTED

FCM1-S6-C14	1.00 (25.4)	2.90 (73.7)	1.21 (30.7)	1.05 (26.7)	.61 (15.5)	Nylon 6.6	Gray	Indoors	#6 (M3) Screw	100	500	200	1000
FCM1.2-S6-C14	1.20 (30.5)	3.16 (80.3)	1.37 (34.8)	1.20 (30.5)	.69 (17.5)					100	500	200	1000
FCM2-S6-C14	2.00 (50.8)	5.06 (128.5)	2.22 (56.4)	2.05 (52.1)	.94 (23.9)				(2) #6 (M3) Screws	100	500	200	1000
FCM3.25-S6-L14	3.25 (82.5)	7.30 (185.4)	3.38 (85.9)	3.23 (82.0)	.94 (23.9)					50	500	200	1000

## Adhesive Backed Flat Cable Mounts — FCH Type

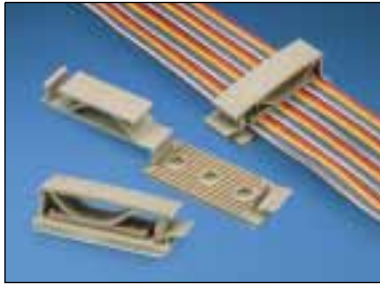

The FCH part is designed for flat cable up to a stack height of .25" (6.3mm) or discrete wire. It is available with adhesive backing or can be screw applied.

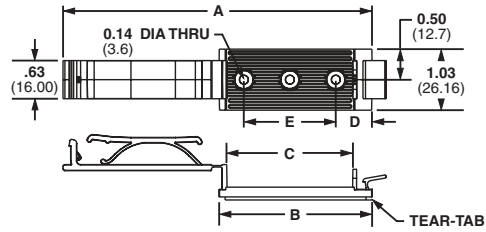

Part Number‡	Cable Width in. (mm)	Dimensions in. (mm)					Material	Color	Where Used	Mounting Method	Packaging*			
		A	B	C	D	E					Std. Pkg. Qty.	Std. Ctn. Qty.	Bulk Pkg. Qty.	Bulk Ctn. Qty.
FCH2-A-C14	2.00 (50.8)	5.00 (128.1)	2.50 (63.0)	2.10 (52.2)	.59 (15.0)	1.50 (38.1)	Nylon 6.6	Gray	Indoors	Rubber Adhesive/Static Load 1.0 lbs. (454g)	100	500	200	1000
FCH2-S6-C14										(2) #6 (M3) Screws	100	500	—	—

## Adhesive Backed Flat Cable Mounts — FCC Type

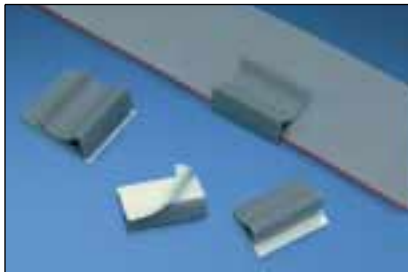

Used with any width flat cable for a maximum stack height of .17" (4.3mm).

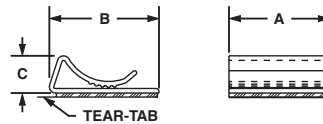

Part Number‡	Cable Width in. (mm)	Dimensions in. (mm)			Material	Color	Where Used	Mounting Method	Packaging*			
		A	B	C					Std. Pkg. Qty.	Std. Ctn. Qty.	Bulk Pkg. Qty.	Bulk Ctn. Qty.
FCC5-A-C8	Any width flat cable	1.00 (25.4)	.56 (14.1)	.29 (7.4)	PVC	Gray	Indoors	Rubber Adhesive/Static Load .25 lbs. (113g)	100	1000	500	5000
FCC-A-C8		1.00 (25.4)	1.09 (27.7)	.38 (9.7)				Rubber Adhesive/Static Load .50 lbs. (227g)	100	1000	500	5000

\*Order the number of pieces required in multiples of package quantities.

‡Part numbers listed are for standard materials in standard package quantities. For Bulk package part numbers, see page 137-138.

**PAN-CLAMP™**  
**Heavy Duty Fixed**  
**Diameter Clamp with**  
**Integrated Fastener**

PANDUIT® PAN-CLAMP™ Heavy Duty Fixed Diameter Clamps offer easy installation and economical assembly for a wide variety of applications.

- Integrated fastener replaces up to a five piece assembly
- Anchors with 70 lbs. (31.8kg) of pull out force and supports 125 lbs. (56.7kg) of shear



1. Install into 1/8" (3.2mm) thick panel or bracket with a hole diameter of 0.281" (7.1mm) typical clearance hole for 1/4" (6mm) bolts.



2. Molded barbs keep the clamp secured in the hole during assembly.



3. Rivet installs easily by hand. No special tools required.

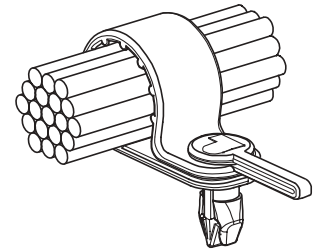
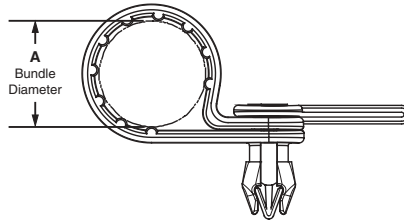
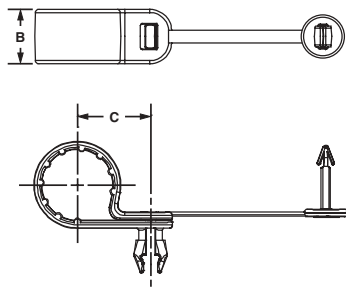

Part Number‡	Dimensions in. (mm)			Material	Color	Panel Hole Size in. (mm)	Panel Thickness in. (mm)	Packaging*			
	A	B	C					Std. Pkg. Qty.	Std. Ctn. Qty.	Bulk Pkg. Qty.	Bulk Ctn. Qty.
PC038-H25D-C0	3/8 (9.5)	.62 (15.7)	.65 (16.5)	Impact Modified Weather Resistant Nylon 6.6	Black	.275 (7.0)	.126 (3.2)	100	500	500	1000
PC050-H25D-C0	1/2 (12.7)		.71 (18.0)					100	500	500	1000
PC062-H25D-C0	5/8 (15.8)		.77 (19.6)					100	1000	500	1000
PC075-H25D-C0	3/4 (19.1)		.84 (21.3)					100	1000	500	1000
PC087-H25D-C0	7/8 (22.1)		.90 (22.9)					100	1000	500	1000
PC100-H25D-C0	1 (25.4)		.96 (24.3)					100	1000	200	1000
PC112-H25D-C0	1 1/8 (28.5)		1.02 (25.9)					100	1000	200	1000
PC125-H25D-C0	1 1/4 (31.8)		1.08 (27.4)					100	1000	200	1000

# PANDUIT® Cable and Wire Mounting Devices

## Fixed Diameter Cable Clamps



Durable nylon cable clamps are available in two widths: 3/8" wide for standard use and 1/2" wide for heavy duty use.

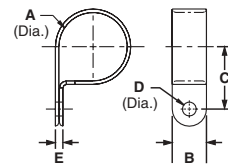

**NOTE:** All parts listed also available in black weather resistant material (-0). Bulk package only.



Part Number‡	Type of Application	Dimensions in. (mm)					Material	Color	Where Used	Mounting Method	Packaging*				
		A	B	C	D	E					Std. Pkg. Qty.	Std. Ctn. Qty.	Bulk Pkg. Qty.	Bulk Ctn. Qty.	
CCS12-S8-C	Standard	.13 (3.1)	.38 (9.5)	.33 (8.4)	.17 (4.2)		Nylon 6.6	Natural	Indoors	#8 (M4) Screw	100	500	1000	5000	
CCS19-S8-C		.19 (4.8)		.43 (10.9)	.17 (4.2)						100	500	1000	5000	
<b>CCS25-S8-C</b>		.25 (6.4)		.41 (10.4)	.17 (4.2)						100	500	1000	5000	
CCS25-S10-C		.25 (6.4)		.41 (10.4)	.20 (5.1)						100	500	1000	5000	
CCS31-S8-C		.31 (7.9)		.49 (12.4)	.17 (4.2)						100	500	1000	5000	
CCS38-S8-C		.38 (9.5)		.57 (14.5)	.17 (4.2)						100	500	1000	5000	
CCS44-S8-C		.44 (11.1)		.59 (15.0)	.17 (4.2)						100	500	1000	5000	
CCS50-S8-C		.50 (12.7)		.60 (15.2)	.17 (4.2)						100	500	1000	5000	
CCH12-S10-C	Heavy Duty	.13 (3.1)	.50 (12.7)	.36 (9.1)	.20 (5.1)		Nylon 6.6	Natural	Indoors	#10 (M5) Screw	100	500	1000	5000	
CCH19-S10-C		.19 (4.8)		.43 (10.8)							.11 (2.6)	100	500	1000	5000
<b>CCH25-S10-C</b>		.25 (6.4)		.46 (11.7)							.11 (2.6)	100	500	1000	5000
CCH31-S10-C		.31 (7.9)		.50 (12.7)							.11 (2.6)	100	500	1000	5000
<b>CCH38-S10-C</b>		.38 (9.5)		.53 (13.5)							.11 (2.6)	100	500	1000	5000
CCH44-S10-C		.44 (11.1)		.56 (14.2)							.11 (2.6)	100	500	1000	5000
<b>CCH50-S10-C</b>		.50 (12.7)		.60 (15.1)							.11 (2.6)	100	500	1000	5000
CCH56-S10-C		.56 (14.3)		.63 (15.9)							.11 (2.6)	100	500	1000	5000
CCH62-S10-C		.63 (15.9)		.66 (16.8)							.11 (2.6)	100	500	1000	5000
CCH69-S10-C		.69 (17.5)		.76 (19.2)							.11 (2.6)	100	500	500	5000
CCH75-S10-C		.75 (19.1)		.79 (19.9)							.11 (2.6)	100	500	500	5000
CCH81-S10-C		.81 (20.7)		.81 (20.7)							.11 (2.6)	100	500	500	5000
CCH87-S10-C		.87 (22.2)		.85 (21.5)							.11 (2.6)	100	500	500	5000
CCH100-S10-C		1.00 (25.4)		.91 (23.1)							.11 (2.6)	100	500	500	5000
CCH112-S10-C		1.13 (28.6)		.97 (24.6)							.13 (3.1)	—	—	100	500
CCH119-S10-C		1.19 (30.2)		1.00 (25.4)							.13 (3.1)	—	—	100	500
CCH125-S10-C		1.25 (31.8)		1.06 (26.9)							.13 (3.1)	—	—	100	500
CCH138-S10-C		1.38 (34.9)		1.13 (28.6)							.13 (3.1)	—	—	100	500
CCH150-S10-C	1.50 (38.1)	1.19 (30.2)	.13 (3.1)	—	—	100	500								

\*Order the number of pieces required in multiples of package quantities.  
 ‡Part numbers listed are for standard materials in standard package quantity (except CCH112 through CCH150).  
 For Bulk package part numbers, see page 137-138.

## Tension Wire Retainers

Wires slide into the clip and are held in place by tension.

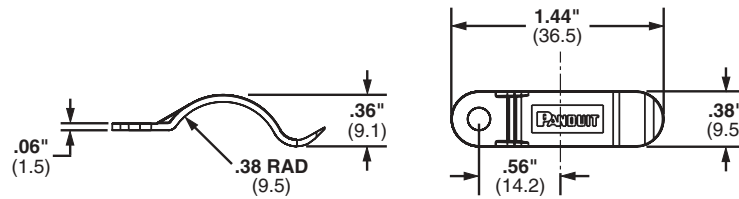

Part Number‡	Bundle Diameter in. (mm)	Dimensions in. (mm)	Material	Color	Where Used	Mounting Method	Packaging*			
							Std. Pkg. Qty.	Std. Ctn. Qty.	Bulk Pkg. Qty.	Bulk Ctn. Qty.
TWR-C	.38 (9.5)	See Drawing	Nylon 6.6	Natural	Indoors	#6 (M3) Screw	100	1000	1000	5000
TWR-C0			Weather Resistant Nylon 6.6	Black	Indoors/Outdoors		100	1000	—	—

## Tack Clips

Used for securing wire, cable and tubing to nailable surfaces. The clips are furnished with a single integral zinc plated, hardened steel nail to help speed installation.

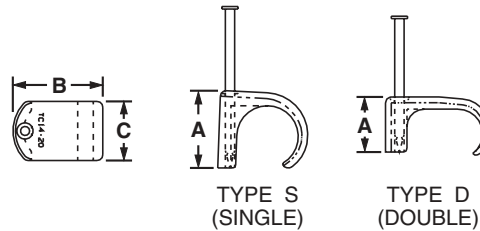

Part Number	Type	Bundle Capacity in. (mm)	Dimensions in. (mm)			Coaxial Cross RG#	Material	Color	Where Used	Mounting Method	Packaging*			
			A	B	C						Std. Pkg. Qty.	Std. Ctn. Qty.	Bulk Pkg. Qty.	Bulk Ctn. Qty.
TC3-5-C100	S	.13 dia. (3.5)	.20 (5.1)	.29 (7.4)	.23 (5.8)	187	Weather Resistant Polypropylene	Black	Indoors/Outdoors	Nail is hammered into a nailable surface such as wood or mortar joints. Do not use on concrete or brick.	—	—	100	1000
TC5-7-C100	S	.21 dia. (5)	.31 (7.9)	.39 (9.9)	.23 (5.8)	58					—	—	100	1000
TC7-10-C100	S	.26 dia. (6.5)	.38 (9.7)	.49 (12.5)	.35 (8.9)	59					—	—	100	1000
TC10-14-C100	S	.36 dia. (9.2)	.51 (13)	.59 (14.9)	.45 (11.4)	6A					—	—	100	1000
TC14-20-C100	S	.49 dia. (12)	.67 (17)	.79 (20.6)	.54 (13.7)	8A, 9B, 11					—	—	100	1000
TC5x8-C100	D	.20 x .30 (5 x 8)	.30 (8.8)	.54 (13.7)	.27 (6.8)	—					—	—	100	1000
TC6x10-C100	D	.23 x .37 (6 x 9.5)	.34 (8.6)	.62 (15.7)	.34 (8.6)	—					—	—	100	1000
TC7x14-C100	D	.26 x .46 (7 x 12)	.36 (9.1)	.70 (17.8)	.43 (10.9)	—					—	—	100	1000
TC9x18-C100	D	.38 x .65 (10 x 17)	.50 (12.7)	.89 (22.6)	.52 (13.2)	—					—	—	100	1000

## Siding Clips

Attaches coax cable to buildings having “Pittsburgh Interlok” type aluminum or steel siding. Will not corrode or stain siding. Low profile, installs without drilling or nailing.

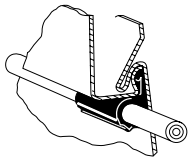

Horizontal Siding Clip

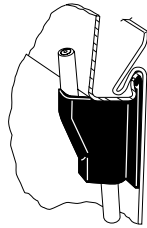

Vertical Siding Clip

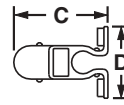
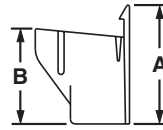

VSC Vertical Clip

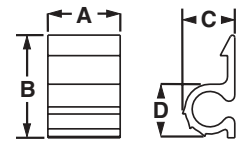

HSC Horizontal Clip

Part Number‡	Max. Cable Dia. in. (mm)	Dimensions in. (mm)				Material	Color	Mounting Method	Packaging*	
		A	B	C	D				Std. Pkg. Qty.	Std. Ctn. Qty.
HSC.25-L	.25 (6.4)	.50 (12.7)	.71 (18.0)	.34 (8.6)	.37 (9.4)	Nylon 6.6	White	Attach to Siding	50	500
HSC.25-L100						Weather Resistant Polypropylene	Black		50	500
VSC.25-L		1.26 (31.8)	.98 (25.0)	1.00 (25.4)	.70 (17.8)	Nylon 6.6	White		50	500
VSC.25-L100						Weather Resistant Polypropylene	Black		50	500

\*Order the number of pieces required in multiples of package quantities.

‡Part numbers listed are for standard materials in standard package quantity. For Bulk package part numbers, see page 137-138.

## Wire Standoffs

For retaining wires, cable, components or tubing away from panel or conductive chassis. Finger grip flanges can be easily locked or unlocked for revisions. Hand installed in pre-drilled hole.

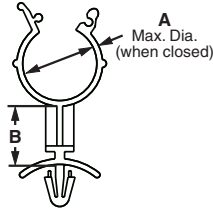
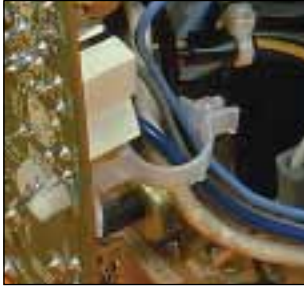

Easy to install and use.

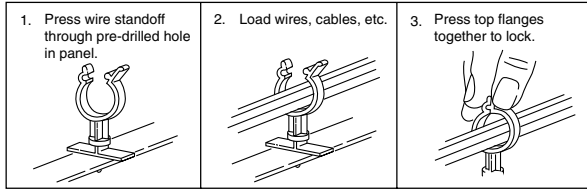

Part Number‡	Dimensions in. (mm)		Panel Dimensions in. (mm)		Material	Color	Where Used	Mounting Method	Packaging*			
	A	B	Panel Thickness	Hole Diameter					Std. Pkg. Qty.	Std. Ctn. Qty.	Bulk Pkg. Qty.	Bulk Ctn. Qty.
WS25-25-C	.25 (6.4)	.25 (6.4)	.03 to .08 (0.7 to 2.0)	.19 to .20 (4.7 to 4.9)	Nylon 6.6	Natural	Indoors	Inserted into Pre-Drilled Hole	100	1000	—	—
WS25-50-C	.25 (6.4)	.50 (12.7)							100	1000	—	—
WS25-75-C	.25 (6.4)	.75 (19.1)							100	1000	—	—
WS35-25-C	.35 (8.9)	.25 (6.4)							100	1000	—	—
WS35-50-C	.35 (8.9)	.50 (12.7)							100	1000	—	—
WS35-75-C	.35 (8.9)	.75 (19.1)							100	1000	—	—
WS50-25-C	.47 (11.9)	.25 (6.4)							100	1000	—	—
WS50-50-C	.47 (11.9)	.49 (12.7)							100	1000	—	—
WS50-75-C	.47 (11.9)	.75 (19.1)							100	1000	—	—
WS75-25-C	.78 (19.8)	.25 (6.4)							100	1000	1000	5000
WS75-50-C	.78 (19.8)	.50 (12.7)							100	1000	1000	5000
WS75-75-C	.78 (19.8)	.75 (19.1)							100	1000	1000	5000

## Snap-In Clips

The clips hold wire bundles securely. Clips are placed on the bundle then attached to the panel. Designed for pre-drilled holes.

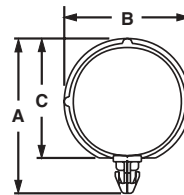

Part Number‡	Max. Bundle Dia. in. (mm)	Dimensions in. (mm)			Material	Color	Where Used	Panel Dimensions in. (mm)		Mounting Method	Packaging*			
		A	B	C				Maximum Thickness	Hole Diameter		Std. Pkg. Qty.	Std. Ctn. Qty.	Bulk Pkg. Qty.	Bulk Ctn. Qty.
SICH25-C	.25 (6.4)	.82 (20.9)	.34 (8.6)	.40 (10.2)	Nylon 6.6	Natural	Indoors	.10 (2.5)	.25 (6.4)	Inserted into Pre-Drilled Hole	100	1000	1000	5000
SICH38-C	.38 (9.6)	.98 (24.6)	.50 (12.8)	.54 (13.7)							100	1000	1000	5000
SICH50-C	.50 (12.7)	1.11 (26.2)	.62 (15.7)	.67 (17.0)							100	1000	1000	5000
SICH75-C	.75 (19)	1.40 (35.6)	1.0 (25.4)	.96 (24.4)							100	1000	1000	5000
SICH100-C	1.00 (25.4)	1.65 (41.9)	1.25 (31.8)	1.21 (30.7)							100	1000	—	—
SICH150-C	1.5 (38)	2.15 (54.6)	1.75 (44.5)	1.71 (43.4)							100	1000	—	—



## Wire Saddles



Funnel entry design for fast insertion of wires and cables. Used in pre-drilled holes.



VWS  
Vertical

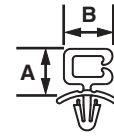

HWS  
Horizontal



Part Number‡	Max. Bundle Capacity in. (mm)	Dimensions in. (mm)		Material	Color	Where Used	Panel Dimensions in. (mm)		Mounting Method	Packaging*			
		A	B				Panel Thickness	Hole Diameter		Std. Pkg. Qty.	Std. Ctn. Qty.	Bulk Pkg. Qty.	Bulk Ctn. Qty.
VWS4218-C	.18 x .42 (5 x 11)	.58 (14.7)	.60 (15.2)	Nylon 6.6	Natural	Indoors	.03-.08 (.79 - 2.0)	.19 (4.7)	Inserted into Pre-Drilled Hole	100	500	1000	5000
VWS4238-C	.40 x .42 (10 x 11)	.78 (19.8)	.60 (15.2)							100	500	1000	5000
VWS4274-C	.74 x .42 (19 x 11)	1.14 (29.0)	.60 (15.2)							100	500	1000	5000
VWS42105-C	1.05 x .42 (27 x 11)	1.45 (36.8)	.60 (15.2)							100	500	1000	5000
HWS2819-C	.19 x .28 (5 x 7)	.42 (10.7)	.44 (11.2)							100	500	1000	5000

## Harness Clips



Integral “spring” holds wire bundles tightly. Used in pre-drilled holes. Vertical, horizontal, and edge mount versions available.

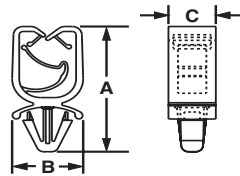

Vertical  
HCMP06B12

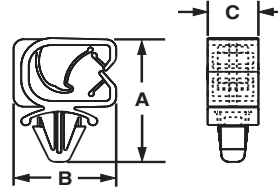

Horizontal  
HCMP06C12

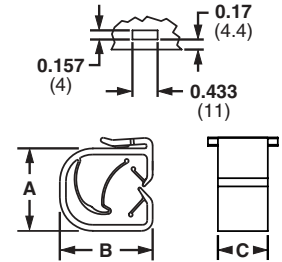

Edge Mount  
HCME06A12

Part Number‡	Max. Bundle Dia. Range in. (mm)	Dimensions in. (mm)			Material	Color	Where Used	Panel Dimensions in. (mm)		Mounting Method in. (mm)	Packaging*			
		A	B	C				Maximum Thickness	Hole Diameter		Std. Pkg. Qty.	Std. Ctn. Qty.	Bulk Pkg. Qty.	Bulk Ctn. Qty.
HCMP06B12-C20	.24-.47 (5.9-2.5)	1.25 (31.8)	.74 (18.8)	.39 (10)	Nylon 6.6	Black	Indoors	.11 (2.7)	.25 (6.4)	Inserted into Pre-Drilled Hole	100	500	1000	5000
HCMP06C12-C20		1.10 (27.9)	.80 (20.2)	100							500	1000	5000	
HCME06A12-C130		.59 (15.0)	.74 (18.7)	.39 (9.9)	Acetal	—	—	See Drawing	100	500	5000	10000		

\*Order the number of pieces required in multiples of package quantities.

‡Part numbers listed are for standard materials in standard package quantity. For Bulk package part numbers, see page 137-138.

## Wire Bundle Strap



Wire Bundle Strap provides a quick, durable and inexpensive way to contain wire, cable and tubing. It can be installed on wood, plywood, masonry and other surfaces using standard fasteners.

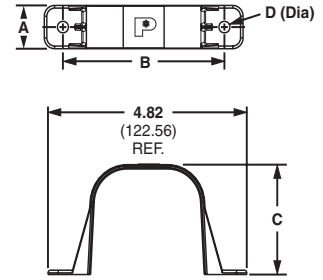

Part Number	Bundle Retaining Area in <sup>2</sup>	Material	Color	Dimensions in. (mm)				Mounting Method	Std. Pkg. Qty.*	Std. Ctn. Qty.
				A	B	C	D			
WBS6-Q	6	ABS	Natural	1.00 (25.4)	3.92 (99.6)	2.54 (64.5)	.25 (6.35)	1/4 (M6) Screw	25	125

## Circuit Board Posts



For board-to-board or board-to-chassis mounting. Posts snap into pre-drilled holes. Bell flange on bottom end provides greater stability.

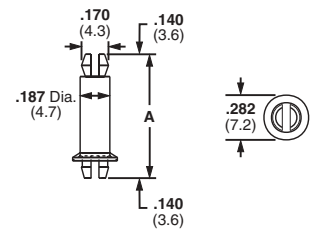

Part Number‡	Dimensions in. (mm)		Material	Color	Where Used	Mounting Method in. (mm)	Packaging*			
	Standoff Height	A					Std. Pkg. Qty.	Std. Ctn. Qty.	Bulk Pkg. Qty.	Bulk Ctn. Qty.
CBP12-C	.125 (3.2)	.405 (10.3)	Nylon 6.6	Natural	Indoors	For Circuit Boards or Chassis: .062 (1.5) thick with .158 (4.0) diameter mounting holes	100	1000	1000	5000
CBP25-C	.250 (6.4)	.530 (13.5)					100	1000	1000	5000
CBP31-C	.312 (7.9)	.592 (15.0)					100	1000	1000	5000
CBP37-C	.375 (9.5)	.655 (16.6)					100	1000	1000	5000
CBP50-C	.500 (12.7)	.780 (19.8)					100	1000	1000	5000
CBP62-C	.625 (15.9)	.905 (23.0)					100	1000	1000	5000
CBP75-C	.750 (19.1)	1.030 (26.2)					100	1000	1000	5000
CBP87-C	.875 (22.2)	1.155 (29.3)					100	1000	1000	5000
CBP100-C	1.00 (25.4)	1.280 (32.5)					100	1000	1000	5000

**Circuit Board Locking Supports**

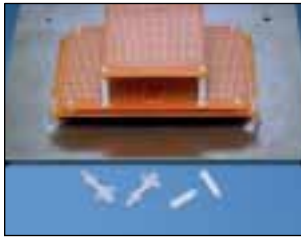

For board-to-chassis support. Snap-in design for fast assembly. Wing design on chassis mounting provides constant tension and stability.

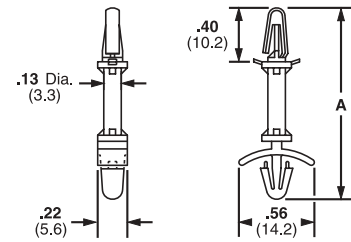

Part Number‡	Dimensions in. (mm)		Material	Color	Where Used	Mounting Method in. (mm)	Packaging*			
	Standoff Height	A					Std. Pkg. Qty.	Std. Ctn. Qty.	Bulk Pkg. Qty.	Bulk Ctn. Qty.
CBLS18-C	.187 (4.7)	.92 (23.4)	Nylon 6.6	Natural	Indoors	For Circuit Boards: .062 (1.5) thick with .158 (4.0) diameter mounting holes  For Chassis: .03 (.79) to .08 (2.0) thick with .185 (4.7) to .193 (4.9) diameter mounting holes	100	500	1000	5000
CBLS25-C	.250 (6.4)	.98 (24.9)					100	1000	1000	5000
CBLS37-C	.375 (9.5)	1.11 (28.2)					100	1000	1000	5000
CBLS50-C	.500 (12.7)	1.23 (31.2)					100	1000	1000	5000
CBLS62-C	.625 (15.9)	1.35 (34.3)					100	1000	1000	5000
CBLS75-C	.750 (19.1)	1.48 (37.5)					100	1000	1000	5000

\*Order the number of pieces required in multiples of packaging quantities.  
‡Part numbers listed are for standard materials in standard package quantity.  
For Bulk package part numbers, see page 137-138.

## Harness Board Accessories

PANDUIT® harness board accessories provide fast routing and forming of wires in harness fabrication. They hold the wires off the harness board at a uniform height for easy application of cable ties. The accessories are designed for use with various PANDUIT® cable tie installation tools. The Low accessories are used with hand-operated tools. The High accessories are used with the automatic tools. To maintain the harness at a uniform height of approx. 1.33" (33.8mm) (at the center of the harness) above the board, use RER Elastic Retainers, BR.75-E6 (or BR.5-E6), CPH.75-S8, TJF and SHH1-S8 or SHH3-S8 harness board accessories. This height is suitable for use with the PAT1M Fully Automatic Cable Tie Installation system (page 60).



### Wire Retainers — RER Type Replaceable Elastic Retainers

As wires are individually inserted, the bundle is formed. When harness is complete, it can be easily snapped out. Three sizes available for 1/2" (12.7mm), 3/4" (19.0mm) and 2 1/4" (31.8mm) bundles.

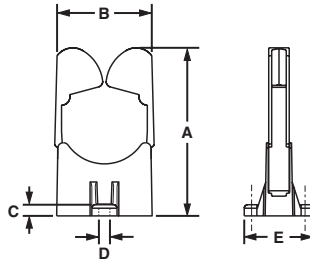

**Replacement Elastic**  
For economy, the elastic band can be replaced in the RER Elastic Retainers without removing the RER base.

Part Number	Pkg. Qty.
RER.5E-X	10
RER.75E-X	10
RER1.25E-X	10

Part Number	Max. Dia. in. (mm)	Dimensions in. (mm)					Color & Material	Mounting Method	Std. Pkg. Qty.*	Std. Ctn. Qty.
		A	B	C	D	E				
RER.5-S6-X	.50 (12.7)	1.89 (48.0)	.84 (21.3)	.18 (4.7)	.14 (3.6)	1.18 (30.0)	Black Nylon 6.6 and White Acetal	#6 (M3) Screw	10	50
RER.75-S6-X	.75 (19.0)	2.21 (56.1)	1.12 (28.4)		.14 (3.6)				10	50
RER1.25-S6-X	1.25 (31.8)	2.86 (72.6)	1.64 (41.7)		.14 (3.6)				10	50

### ER Type Elastic Retainers

ER Type retainers form wire bundles as wires are inserted. Completed bundles then snap out. Two sizes available for 1/2" (12.7) and 1 1/4" (31.7) bundles.

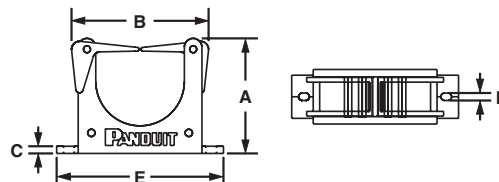

Part Number	Max. Dia. in. (mm)	Dimensions in. (mm)					Color & Material	Mounting Method	Std. Pkg. Qty.*	Std. Ctn. Qty.
		A	B	C	D	E				
ER.5-E4-X	.50 (12.7)	1.00 (25.4)	1.00 (25.4)	.13 (3.2)	.12 (3.0)	1.96 (49.8)	Black Nylon 6.6 and ABS	#4 (M2.5) Screws	10	100
ER1.25-E4-X	1.25 (31.8)	2.00 (50.8)	2.40 (61.0)		.12 (3.0)	2.90 (73.7)			10	100

## Bundle Retainers

Spring fingers with large lead in facilitate fast routing of wires and easy removal of completed harness. Overlapping feet on the BR.5 and BR.75 allow the retainers to be butted together for wire breakouts. Three sizes available for 1/2" (12.7mm), 3/4" (19.0mm) and 2.00" (50.8mm) bundles.

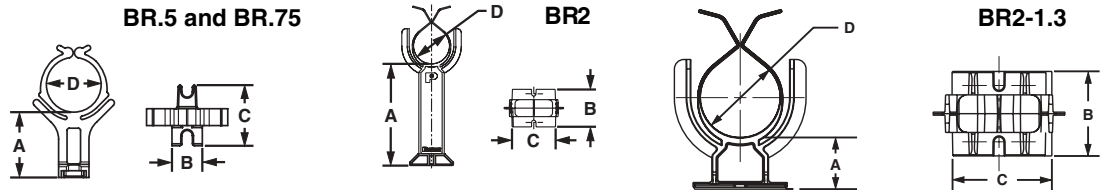

Part Number	Max. Dia. in. (mm)	Dimensions in. (mm)				Color & Material	Mounting Method	Packaging*	
		A	B	C	D			Std. Pkg. Qty.	Std. Ctn. Qty.
BR.5-E6-C	.50 (12.7)	1.07 (27.2)	.44 (11.2)	.78 (19.8)	.55 (14.0)	Black Acetal	(2) #6 (M3) Screws	100	500
BR.75-E6-C	.75 (19.0)	.95 (24.1)			.76 (19.4)			100	500
BR2-1.3-X	2.00 (50.8)	1.32 (33.5)	2.25 (57.2)	2.50 (63.5)	2.12 (54.0)		(2) 1/4 (M6) Screws	10	100
BR2-1.3-A-X							Rubber Adhesive 2.0 lbs (907g) Static Load	10	100
BR2-1.5-X		1.59 (40.4)	2.18 (55.4)	2.56 (65.0)			(2) 1/4 (M6) Screws	10	100
BR2-4-X		4.00 (101.6)						10	100
BR2-6-X		6.00 (152.4)				10		100	

## Corner Posts

Designed to pre-form tight bundles at harness corners and breakouts. The top arm pivots for easy removal of completed harness.



CPH Corner Post, High

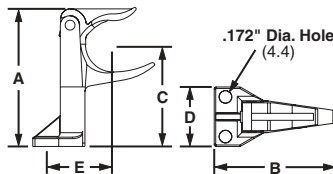

CPL Corner Post, Low

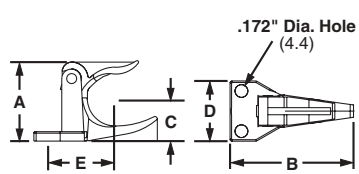

Part Number	Max. Dia. in. (mm)	Dimensions in. (mm)					Color & Material	Mounting Method	Packaging*	
		A	B	C	D	E			Std. Pkg. Qty.*	Std. Ctn. Qty.
CPH.75-S8-X	.75 (19.0)	1.88 (47.8)	1.60 (40.8)	1.35 (34.4)	.90 (22.9)	1.18 (30.0)	Black Nylon 6.6	(2) #8 (M4) Screws	10	100
CPL.75-S8-X		1.08 (27.4)	1.52 (38.6)	.56 (14.2)	.88 (22.4)	1.11 (28.2)			10	100

\*Order the number of pieces required in multiples of package quantities.

## T-Junction Fixture



In the "up" position to form harness.

In the "down" position to tie and remove harness.

Using an integrated harness board nail, the T-Junction Fixture moves to form harnesses. When the harness is complete, the fixture can be pushed down for easy harness removal.

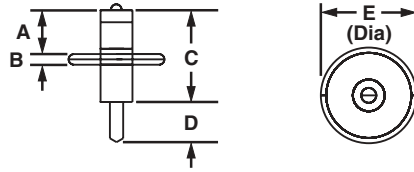

Part Number	Max. Bundle Dia. in. (mm)	Dimensions in. (mm)					Color & Material	Mounting Method	Std. Pkg. Qty.*	Std. Ctn. Qty.
		A	B	C	D	E				
TJF-X	1.34 (34.0)	.75 (19.0)	.12 (3.0)	1.39 (35.1)	.70 (17.8)	1.12 (28.4)	Black Nylon 6.6 and Nickel Plated Steel	Integral Nail	10	100

## Wire End Holder



Secures wire ends with or without terminations while harness is being fabricated. Wires can be easily added or removed from the top, but will hold the wire from axial movement. Used with #28 through #16 AWG wires.

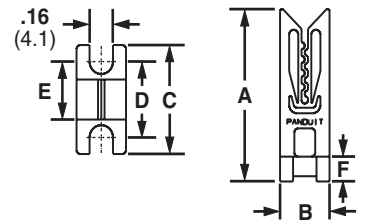

Part Number	Dimensions in. (mm)						Color & Material	Mounting Method	Std. Pkg. Qty.*	Std. Ctn. Qty.
	A	B	C	D	E	F				
WEH-E8-C	1.22 (31.0)	.37 (9.4)	.77 (20.0)	.53 (13.5)	.29 (7.4)	.18 (4.6)	Black Acetal	(2) #8 (M4) Screws	100	1000

## Harness Board Nails



Speeds routing of wires. All of the nails have a uniform driving depth insured by a collar stop. Smooth finish on the nails, will not abrade wire jackets.

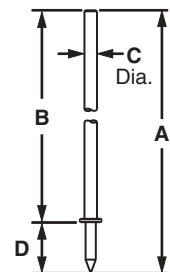

Part Number	Dimensions in. (mm)				Material	Mounting Method	Std. Pkg. Qty.*	Std. Ctn. Qty.
	A	B	C	D				
HBN.75-T	1.40 (35.6)	.75 (19.0)	.075 (1.9)	.62 (15.8)	Nickel Plated Steel	Hammered into harness board	200	1000
HBN1-T	1.65 (41.9)	1.00 (25.4)	.075 (1.9)				200	1000
HBN1.5-T	2.15 (54.6)	1.50 (38.1)	.084 (2.1)				200	1000
HBN2-T	2.65 (67.3)	2.00 (50.8)	.093 (2.4)				200	1000
HBN2.5-T	3.17 (80.5)	2.50 (63.5)	.107 (2.7)				200	1000
HBN3-T	3.67 (93.2)	3.00 (76.2)	.122 (3.1)				200	1000
HBN4-T	4.67 (118.6)	4.00 (101.6)	.142 (3.6)				200	1000

## Fanning Strip System

Assures that wires are held in a particular orientation in sophisticated wiring harnesses. Consists of fanning strip and fanning strip holder.

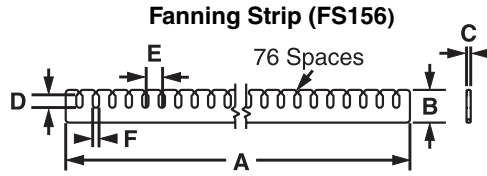

Contains evenly spaced “snap slots” to hold wires in place. No sharp edges to damage wire insulation. Becomes part of the wiring harness. Will accept wires up to 18 AWG. Used with FSH40 or FSHH holders.

## Fanning Strip Holders

**Low Holder (FSH40-X)**

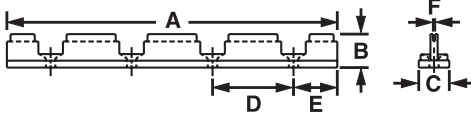

**High Holder (FSHH-X)**

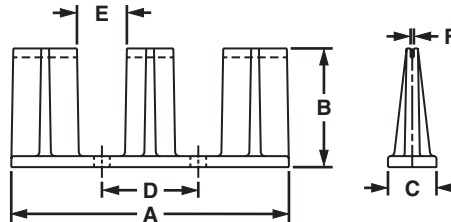

Used in conjunction with RER.75-S6, BR.75-E6 (BR.5-E6) and CPH.75-S8. Ideal for use with PAT cable tie tool.

Part Number	Dimensions in. (mm)						Color & Material	Mounting Method	Std. Pkg. Qty.*
	A	B	C	D	E	F			
FS156-C	12.1 (307.3)	.31 (7.9)	.04 (1.0)	.12 (3.0)	.156 (4.0)	.06 (1.5)	Natural Nylon 6.6	Fanning Strip Holder	100
FSH40-X	6.0 (152.4)	.62 (15.7)	.56 (14.2)	1.50 (38.1)	.75 (19.0)	.04 (1.0)	Black ABS	#8 (M4) Screws	10
FSHH-X	3.2 (81.3)	1.4 (36.0)	.60 (15.2)	1.10 (28.0)	.53 (13.5)	.04 (1.0)			10

\*Order the number of pieces required in multiples of packaging quantities.

## Spring Wire Breakout System

Separates and holds wires in a harness while the rest of the harness is being formed. The wires simply pull out from the spring when the harness is complete.

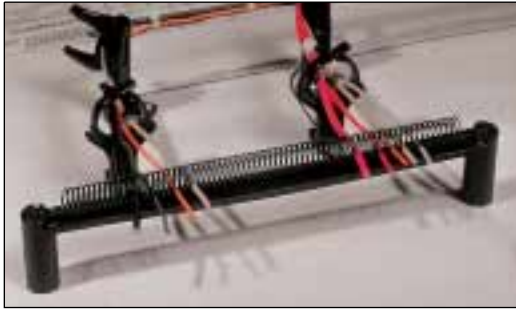

### SHH Spring Holder

Each SHH Spring Holder is supplied with (1) rigid wire piece to hold the spring laterally and two #8 (M4) 2" (50.8) hex head wood screws. Two sizes available for use with PBSC1 and PBSC6.

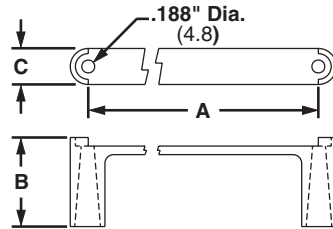

### PBSC Spring Wire Breakout

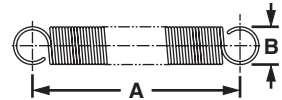

Part Number	Dimensions in. (mm)			Material in. (mm)	Color	Mounting Method	Packaging*	
	A	B	C				Std. Pkg. Qty.	Std. Ctn. Qty.
PBSC1-X	1.00 (25.4)	.44 (11.2)	—	.035 (.9) Thick Steel	—	Used with SHH1 Spring Holder	10	100
PBSC3-X	3.00 (76.2)					(2) #8 (M4) Screws	10	100
PBSC6-X	6.00 (152.4)					Used with SHH3 Spring Holder	10	100
PBSC12-X	12.00 (304.8)					(2) #8 (M4) Screws	10	100
SHH1-S8-X	1.85 (47.0)	1.30 (33)	.53 (13.4)	Nylon 6.6	Black	(2) #8 (M4) Screws used with PBSC1	10	100
SHH3-S8-X	6.85 (174.0)					(2) #8 (M4) Screws used with PBSC3 or PBSC6	10	100



## Harness Board Standoff Posts



Used to hold a push mount accessories or a push mount cable tie at a specific location on a harness board. The Standoff Post is placed over a hole in the harness board, a bolt is then threaded into the bottom of the standoff from the backside of the board and tightened. Push mount accessories are inserted into the top of the Standoff Post prior to assembly. When the assembly is complete, the harness and the attached push mount are removed from the Standoff Post.

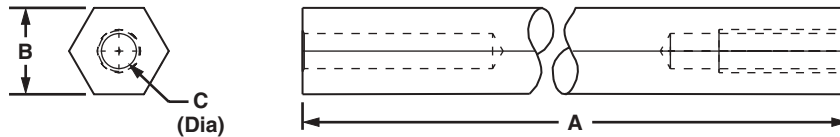

Part Number	Dimensions in. (mm)			Used With Part Numbers	Material	Mounting Method	Packaging*	
	A	B	C				Std. Pkg. Qty.	Std. Ctn. Qty.
HB2SP19-X	2.00 (50.8)	.50 (12.7)	.20 (5.2)	PLWP, PRWP, WS, VWS, HWS, TPM	Aluminum	1/4 (M6) Screw	10	100
HB4SP19-X	4.00 (101.6)						10	100
HB6SP19-X	6.00 (152.4)						10	100
HB2SP25-X	2.00 (51)	.295 (7.5)	.295 (7.5)	PLWP, PRWP, PLP, THMS, HCMP, PMCC	Aluminum	1/4 (M6) Screw	10	100
HB4SP25-X	4.00 (101.6)						10	100

\*Order the number of mounts required in multiples of package quantities.

## Optical Fiber Network Saddles



The product is designed with rounded edges for routing fiber optic cables. This feature provides a very smooth surface to eliminate the potential for snagging and putting stress on the fiber optic cable.

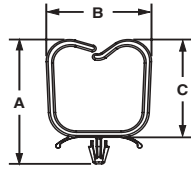

VWS Push Mount Type

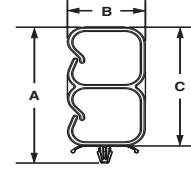
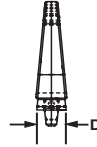

VWSDC Dual Capacity Type



Part Number‡	Max. Bundle Dia. in. (mm)	Dimensions in. (mm)				Material	Color	Where Used	Panel Dimensions in. (mm)		Mounting Method in. (mm)	Packaging*			
		A	B	C	D				Maximum Thickness	Hole Diameter		Std. Pkg. Qty.	Std. Ctn. Qty.	Bulk Pkg. Qty.	Bulk Ctn. Qty.
VWS106-C	1.06 (26.9)	1.65 (41.7)	1.18 (29.9)	1.30 (31.8)	.34 (8.6)	Nylon 6.6	Natural	Indoors	.09 (2.3)	.187 (4.7)	Inserted into Pre-Drilled Hole	100	500	1000	5000
VWS106-C20		2.64 (66.8)	1.26 (32.0)	2.36 (59.9)	.39 (9.9)		Black					100	500	1000	5000
VWSDC-C							Natural					100	1000	500	2500

## Waterfall Accessories



PANDUIT® Waterfall Accessory provides bend radius control in both vertical and horizontal directions when transferring cables from standard ladder rack. Installs easily to the rung or a stringer of the ladder rack with PANDUIT® PLT series cable ties, provided in every package. PANDUIT® Waterfall Accessories are part of a complete cable management system.

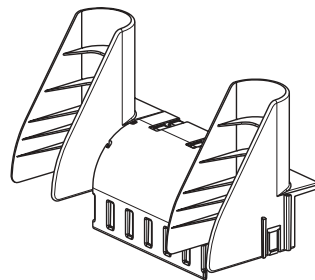

CMW-Kit

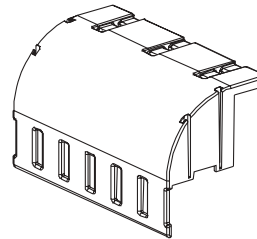

CMWB-Waterfall Base

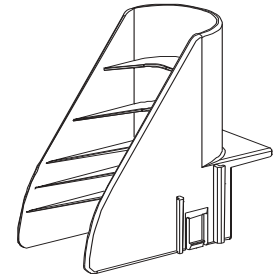

CMWW-Waterfall Wing

Part Number	Bend Radius Limit in. (mm)	Material	Color	Width in. (mm)	Height in. (mm)	Included in Package	Packaging*	
							Std. Pkg. Qty.*	Std. Ctn. Qty.
CMW-KIT	—	Glass Filled Flame Retardant Nylon 6.6	Black	9.60 (243.8)	6.07 (154.18)	One Base, Two Wings, and Three Cable Ties.	1	10
CMW-KIT10			White					
CMWB	Black		5.24 (133.1)	3.07 (77.98)	One Base and Three Cable Ties.			
CMWB10	White							
CMWW	1.0 (25.4)		Black	2.00 (50.6)	4.87 (123.7)	One Bend Radius Control Wing.		
CMWW10			White					

## Stackable Cable Rack Spacers



PANDUIT® Stackable Cable Rack Spacers separate and support cable on standard ladder racks. This product prevents pinch points between the bottom row of cable and the ladder rack rung as a result of the weight of multiple cable layers applied on top of each other. Maximize rack space by stacking products for maximum cable capacity.

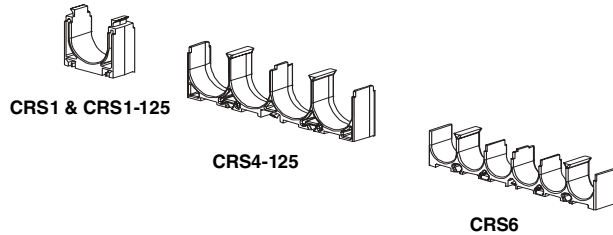

Part Number	Cable Bundles	Bundle Diameter in. (mm)	Material	Color	Mounting Method	Width in. (mm)	Stack Height in. (mm)	Packaging*	
								Std. Pkg. Qty.	Std. Ctn. Qty.
CRS4-125-X	4	1.25 (31.75)	Glass Filled Flame Retardant Nylon 6.6	Black	Standard Cross Section Cable Ties	5.24 (133.1)	1.42 (36.07)	10	100
CRS1-125-X	1					1.55 (39.4)			
CRS6-X	6	0.8 (20.32)	Polycarbonate/ABS Blend			5.25 (133.35)	1.00 (25.4)		
CRS1-X	1					1.13 (28.58)			

## Vertical D-Rings



The PANDUIT® Vertical D-Ring provides open access cable management. The front arm of the D-Ring rotates 90° to allow entire cable bundles to be inserted. Screw holes are spaced according to EIA standards and allow for installation on standard equipment racks.

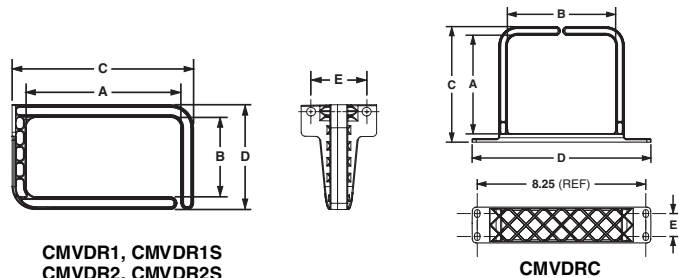

Part Number	Dimensions in. (mm)					Material	Color	Mounting Method	Packaging*	
	A	B	C	D	E				Std. Pkg. Qty.	Std. Ctn. Qty.
CMVDR1	4.80 (121.9)	1.18 (30.0)	5.72 (145.2)	2.05 (52.07)	1.75 (44.45)	Flame Retardant Polycarbonate	Black	(2) 1/4 (M6) Screws	1	10
CMVDR1S	2.4 (60.9)		3.26 (82.8)							
CMVDR2	4.80 (121.9)	2.40 (60.9)	5.72 (145.2)	3.30 (83.82)						
CMVDR2S	2.40 (60.9)	3.26 (82.8)								
CMVDRC	4.72 (119.88)	5.09 (129.29)	5.66 (143.64)	8.75 (222.25)	1.12 (28.58)					

\*Order the number of pieces required in multiples of package quantities.

## Threaded Rod Cover



PANDUIT® Threaded Rod Cover protects cables from abrasion caused by contact with threaded rod.

- Manufactured from material that meets UL94V-0 specifications
- Soft material for easy installation
- Available in 18" lengths

Part Number	For Threaded Rod Size in. (mm)	Material	Color	Packaging*	
				Std. Pkg. Qty.	Std. Ctn. Qty.
TRC18FR-X8	1/2 to 5/8 (12.7 to (15.88))	Flame Retardant Polyethylene	Gray	10	100

## TAK-TY® Hook & Loop Cable Tie Mounts



Mounting base for use with 3/4" TAK-TY® Hook & Loop Cable Ties

- For indoor use only

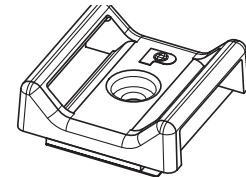
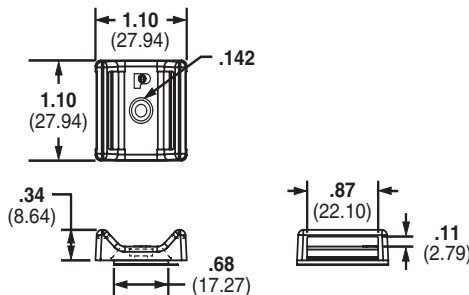

Part Number‡	Used with Cable Ties	Mounting Method	Maximum Static Load lbs. (g)	Material	Color	Packaging*	
						Std. Pkg. Qty.	Std. Ctn. Qty.
ABMT-A-C	TAK-TY® ■ Hook & Loop Cable Ties	Rubber Adhesive	.38 (172)	Nylon 6.6	Natural	100	1000
ABMT-A-C20					Black		
ABMT-S6-C		#6 (M3) Screw	Natural				
ABMT-S6-C20			Black				
ABMT-S6-C60			Black				
ABMT-S6-C69			Flame Retardant Nylon 6.6	Natural			

■Used with all PANDUIT® HLC/HLT/HLS and HLM TAK-TY® options found on page 40.

**Flat PAN-POST™ Standoff**

Used to secure cable in vertical or horizontal configurations. Mounting hole configuration meets EIA/TIA specifications for use on racks or in enclosures.

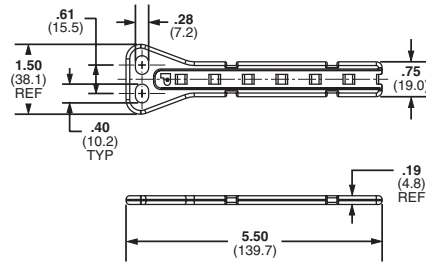

**PPF2S**

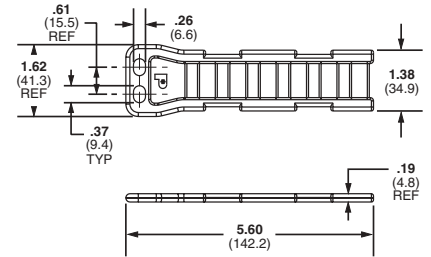

**PPF2SV**

Part Number	Used With Cable Ties**	Dimensions in. (mm)	Color & Material	Mounting Method	Packaging*	
					Std. Pkg. Qty.	Std. Ctn. Qty.
PPF2S-S25-V	M, I, S	See Drawing	Natural Nylon 6.6	(2) 1/4 (M6) Screws	5	50
PPF2S-S25-V69			Natural Flame Retardant Nylon 6.6		5	50
PPF2SV-S25-V	M, I, S, HS, LH, H, HLM■		Natural Nylon 6.6		5	50
PPF2SV-S25-V69			Natural Flame Retardant Nylon 6.6		5	50

■Used with all PANDUIT® Hook & Loop Cable Ties found on [page 40](#).

**Communication Cable Management Kit for Cabinets**

Kit of wire management accessories specifically designed for use in a network cabinet or enclosure.



Kit includes the following:

- TAK-TY® Hook & Loop cable tie (HLM-15R0)/1 roll
- Nylon Cable tie (ILT3S)/24 pieces
- Adhesive backed mounts (ABM3H-A and ABM112-A) 6 pieces each
- Flat Post Standoff (PPF2S-S25)/8 pieces
- Push mount (PWMS-H25)/6 pieces
- Vertical wire saddle (VWS106)/4 pieces

Part Number	Packaging*	
	Std. Pkg. Qty.	Std. Ctn. Qty.
CCMKIT1	1	100

\*Order the number of pieces required in multiples of package quantities.  
 †Part numbers listed are for standard materials in standard package quantities. For Bulk package part numbers, see [page 137-138](#).  
 \*\*Cable Tie Cross Section Sizes: M = Miniature, I = Intermediate, S = Standard, HS = Heavy Standard, LH = Light-Heavy and H = Heavy.

## General Introduction

PANDUIT® adhesive mounts provide a quick, economical and dependable method of supporting, routing and protecting wires or cables. Some are used with PANDUIT® cable ties and others can be used without cable ties. Adhesive backed mounts adhere to a variety of surfaces. This alternative to mechanical fasteners offers the advantage of lower installed cost with safe, easy to use, quality products.

## Applications

- To route wires in control panels and switchboards
- To support bundles of wires away from moving mechanical devices
- Routing and harnessing cables, both indoors and out, to prevent safety hazards
- To organize flat cables in many locations with low profile construction
- Ideal for supporting wire bundles where holes cannot be put into the substrate
- To separate groups of wires for identification



## Markets

- Original Equipment Manufacturers (OEM)
- Construction Industry
- Telecommunication Systems
- CATV
- Aerospace Industry
- Utilities
- Electronic Components
- Transportation Industry
- Appliance Manufacturers
- Maintenance and Repair Operations (MRO)



## General Mount Guidelines

PANDUIT® pressure sensitive adhesive (foam tape) mounts are intended to secure wire bundles or other light objects to smooth surfaces. These mounts are not designed to support excessive loads and should not be used when the maximum expected load exceeds the rated capacity of the mount.

## Choosing the Right Adhesive

PANDUIT® offers two standard pressure sensitive foam tapes which are available on most adhesive backed wiring accessories products. The general purpose tape is produced with a rubber based adhesive and is identified by an “-A” in the part number. This tape develops its strength extremely fast and can be used in environments with temperatures ranging from -20°F to +120°F. It is recommended that rubber based adhesive mounts dwell 2 hours after installation, prior to loading. Rubber based adhesive tape is the best choice for most adhesive mount applications, including powder coated surfaces.

Acrylic based adhesive tape is also available and is identified by an “-AT” in the part number. This tape is for use in environments where continuous exposure to temperatures as high as 180°F is possible. Acrylic based adhesive develops its maximum strength over a longer period of time than rubber based adhesive. It is recommended that acrylic adhesive mounts dwell 8 hours after installation, prior to loading. Acrylic based adhesive tape is a good choice for environments with prolonged exposure to UV rays or temperatures above 120°F.

PANDUIT® also offers a two-part epoxy for use in applications where excessive loading is required, or where the surface to which the mount must be applied is porous rather than smooth. This adhesive is formulated specifically for use on PANDUIT® mounts, and is packaged in pre-measured cups to insure the proper ratio of resin and hardener are mixed, eliminating wasted epoxy.

## Application Chart

Since *PANDUIT*® manufactures adhesive backed mounts with a variety of adhesive types, this chart should be used as a guideline for choosing the best adhesive for often-encountered conditions. Each type of adhesive is rated good, fair or poor for some specific mounting surfaces and/or chemical environments.

Surfaces	Rubber Based Foam Tape Mounts	Acrylic Based Foam Tape Mounts	Epoxy Applied Adhesive Mounts
Plastics	Good	Good	Good
Wood	Good	Good	Good
Glass	Fair	Good	Good
Painted Surfaces	Good	Good	Fair
Powder Coating	Good	Fair	Good
Metal	Good <sup>1</sup>	Good <sup>1</sup>	Good
Paper	Good	Good	Fair
Concrete, Stone, Masonry	Not Recommended	Not Recommended	Good
<b>Chemical Resistance</b>			
Water	Good	Good	Poor
Oil	Poor	Fair <sup>3</sup>	Good
Gasoline	Poor	Fair <sup>3</sup>	Fair
Dilute Acids	Poor	Fair <sup>3</sup>	Fair
Dilute Alkalis	Good	Fair <sup>3</sup>	Fair
Organic Solvents	Poor	Fair <sup>3</sup>	Not Recommended
Outdoor Exposure	Not Recommended	Good	Good <sup>2</sup>

1. Not recommended for use on copper or brass.
2. Mounts manufactured from outdoor material only. For specific applications, individual testing prior to extensive use is suggested.
3. Depends on concentration, exposure time and chemical composition.

## Mount Spacing

To determine the number of mounts to use in a given application, the following formula can be used as a guideline:

$$\frac{\text{Cable or weight (lbs./ft.)}}{\text{Static Load rating of Mount (lbs/mt.)}} = \text{Spacing} \frac{\text{Mounts}}{\text{Ft.}}$$

For specific applications we recommend individual testing prior to production use.

## Surface Preparation

For best results, *PANDUIT*® adhesive mounts should be applied to clean, dry, grease-free surfaces. We recommend that the surface be cleaned prior to mount installation. For rubber and acrylic based foam tape adhesives, a blend of isopropyl alcohol and water 50/50 may be used to clean most surfaces.

For epoxy type adhesives, especially masonry surfaces, be sure to clean all loose particles away before mount installation. Some surface abrasion is recommended to achieve maximum strength. A light rubbing with medium grit emery cloth or sandpaper is best. Wash after abrading.

## Proper Installation Techniques For Pressure Sensitive Adhesive Mounts

For proper installation of adhesive mounts with foam tape, simply remove the release liner and place the mount in the desired location. Avoid touching the adhesive prior to positioning the mount. Apply firm pressure to the mount for 5 seconds to insure proper adhesion.



Clean surface with a clean cloth and isopropyl alcohol.

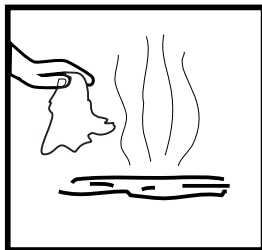

Allow surface to air dry.

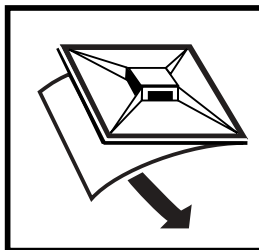

Remove the release liner, being careful not to touch the adhesive.

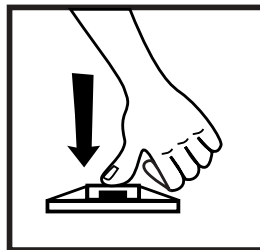

Apply full thumb pressure for at least 5 seconds.

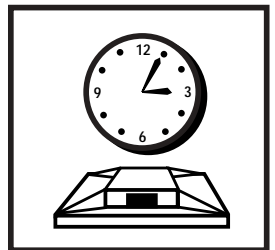

Allow mount to properly dwell.

## Epoxy Adhesive Mounts

*PANDUIT*® EMA adhesive is a two-part epoxy cement which is packaged in convenient mixer cups containing an equal amount of resin and hardener. Peel the protective covering off and pop the center of the cup in to form a mixing bowl. Each cup is supplied with a mixer stick and contains enough epoxy to properly apply three EMS mounts. The resin and hardener should be thoroughly mixed together until the epoxy is a consistent and uniform color. The mixer stick can then be used to apply the adhesive to the mount. The epoxy should be forced into the grooves on the bottom of the mount to obtain optimum bond performance. The mount should be applied to the surface with light pressure and a back-and-forth twisting motion. Hardening of the epoxy begins five minutes after mixing at room temperature.

## Proper Storage Conditions

All *PANDUIT*® adhesive products have an expiration date printed on the package label. Use the following storage guidelines:

1. For rubber and acrylic based foam tape adhesives, store in temperatures of 70°F (21°C) and 45% Relative Humidity (R.H.).
2. For epoxy type adhesives, store in temperatures of 40°F (4°C) to 75°F (25°C) and relative humidity not in excess of 45%. Storage in opened containers is not recommended. Using the guidelines above, the shelf life of foam tape is 3 years. Shelf life of epoxy is 1 year. Deviation from the recommended storage conditions may reduce the shelf life or adhesive strength. In any case, adhesive products should never be stored near heating vents or other heat sources, and storage in lower temperatures than those recommended may increase the shelf life.

## Stock Rotation

Adhesive mount inventory should be rotated in order to insure the quality of the adhesive foam tape. Each package of *PANDUIT*® adhesive backed mounts has a Quality Control Number and a best-if-used-by date on the package label. The best-if-used-by date provides the customer with an accurate way to control the rotation of inventory, and, as is the case with all *PANDUIT*® products, the Quality Control Number provides complete traceability for all components that go into a specific production run of product.



## Mount Removal

There is no simple or easy method for removing *PANDUIT*® adhesives. A thin wire or razor blade can be moved in between the surfaces when removing foam tape mounts; however, the adhesive residue will remain on the surface. Epoxy adhesives may be removed with a commercial paint stripping solution.



**Bulk Package Part Numbers**

The following is an alpha-numeric cross reference of Standard Package Wiring Accessories parts with the corresponding Bulk Package part numbers.

Standard Part No.	Bulk Part No.
<b>A</b>	
ABMM-A-C	ABMM-A-D
ABMM-AT-C	ABMM-AT-D
ABMM-AT-C0	ABMM-AT-D0
ABMS-A-C	ABMS-A-D
ABM1M-A-C	ABM1M-A-M
ABM1M-AT-C	ABM1M-AT-M
ABM100-A-C	ABM100-A-D
ABM100-AT-C	ABM100-AT-D
ABM100-AT-C0	ABM100-AT-D0
ABM100-S6-C	ABM100-S6-D
ABM100-S6-C69	ABM100-S6-D69
ABM112-A-C	ABM112-A-D
ABM112-AT-C	ABM112-AT-D
ABM112-AT-C0	ABM112-AT-D0
ABM112-S6-C	ABM112-S6-D
ABM112-S6-C69	ABM112-S6-D69
ABM2S-A-C	ABM2S-A-D
ABM2S-AT-C	ABM2S-AT-D
ABM2S-AT-C0	ABM2S-AT-D0
ABM3H-A-L	ABM3H-A-T
ABM3H-AT-L	ABM3H-AT-T
ABM4H-A-L	ABM4H-A-T
ABM4H-AT-L	ABM4H-AT-T
ACC19-A-C	ACC19-A-M
ACC19-A-C20	ACC19-A-M20
ACC19-AT-C	ACC19-AT-M
ACC19-AT-C0	ACC19-AT-M0
ACC38-A-C	ACC38-A-M
ACC38-A-C20	ACC38-A-M20
ACC38-AT-C	ACC38-AT-M
ACC38-AT-C0	ACC38-AT-M0
ACC62-A-C	ACC62-A-M
ACC62-A-C0	ACC62-A-M0
ACC62-A-C20	ACC62-A-D20
ACC62-AT-C0	ACC62-AT-M0
AM2-C	AM2-M
ARC.68-A-Q	ARC.68-A-C
ARC.68-A-Q14	ARC.68-A-C14
ARC.68-S6-Q	ARC.68-S6-C
ARC.68-S6-Q14	ARC.68-S6-C14
ASMS-A-X	ASMS-A-T
ASMS-A-X0	ASMS-A-T0
<b>B</b>	
BCS-L100	BCS-D100
BCS-C115	BCS-D115
BEC38-A-L	BEC38-A-T
BEC38-A-L20	BEC38-A-T20
BEC38-A-L0	BEC38-A-T0
BEC62-A-L	BEC62-A-T
BEC62-A-L20	BEC62-A-T20
BEC62-A-L0	BEC62-A-T0
BEC75-A-L	BEC75-A-T
BEC75-A-L20	BEC75-A-T20
BEC75-A-L0	BEC75-A-T0
BECP38H25-L	BECP38H25-T
BECP38H25-L20	BECP38H25-T20
BECP75H25-L	BECP75H25-T
BECP75H25-L20	BECP75H25-T20

Standard Part No.	Bulk Part No.
<b>C</b>	
CBLS18-C	CBLS18-M
CBLS25-C	CBLS25-M
CBLS37-C	CBLS37-M
CBLS50-C	CBLS50-M
CBLS62-C	CBLS62-M
CBLS75-C	CBLS75-M
CBP12-C	CBP12-M
CBP25-C	CBP25-M
CBP31-C	CBP31-M
CBP37-C	CBP37-M
CBP50-C	CBP50-M
CBP62-C	CBP62-M
CBP75-C	CBP75-M
CBP87-C	CBP87-M
CBP100-C	CBP100-M
CCS12-S8-C	CCS12-S8-M
CCS12-S8-C0	CCS12-S8-M0
CCS19-S8-C	CCS19-S8-M
CCS19-S8-C0	CCS19-S8-M0
CCS25-S8-C	CCS25-S8-M
CCS25-S8-C0	CCS25-S8-M0
CCS25-S10-C	CCS25-S10-M
CCS25-S10-C0	CCS25-S10-M0
CCS31-S8-C	CCS31-S8-M
CCS31-S8-C0	CCS31-S8-M0
CCS38-S8-C	CCS38-S8-M
CCS38-S8-C0	CCS38-S8-M0
CCS44-S8-C	CCS44-S8-M
CCS44-S8-C0	CCS44-S8-M0
CCS50-S8-C	CCS50-S8-M
CCS50-S8-C0	CCS50-S8-M0
CCH12-S10-C	CCH12-S10-M
CCH12-S10-C0	CCH12-S10-M0
CCH19-S10-C	CCH19-S10-M
CCH19-S10-C0	CCH19-S10-M0
CCH25-S10-C	CCH25-S10-M
CCH25-S10-C0	CCH25-S10-M0
CCH31-S10-C	CCH31-S10-M
CCH31-S10-C0	CCH31-S10-M0
CCH38-S10-C	CCH38-S10-M
CCH38-S10-C0	CCH38-S10-M0
CCH44-S10-C	CCH44-S10-M
CCH44-S10-C0	CCH44-S10-M0
CCH50-S10-C	CCH50-S10-M
CCH50-S10-C0	CCH50-S10-M0
CCH56-S10-C	CCH56-S10-M
CCH56-S10-C0	CCH56-S10-M0
CCH62-S10-C	CCH62-S10-M
CCH62-S10-C0	CCH62-S10-M0
CCH69-S10-C	CCH69-S10-D
CCH69-S10-C0	CCH69-S10-D0
CCH75-S10-C	CCH75-S10-M
CCH75-S10-C0	CCH75-S10-M0
CCH81-S10-C	CCH81-S10-M
CCH81-S10-C0	CCH81-S10-M0
CCH87-S10-C	CCH87-S10-M
CCH87-S10-C0	CCH87-S10-M0
CCH100-S10-C	CCH100-S10-M
CCH100-S10-C0	CCH100-S10-M0

Standard Part No.	Bulk Part No.
<b>E</b>	
EMA-X	STD. ONLY
EMS-A-C	EMS-A-D
EMS-A-C0	EMS-A-D0
EMSK3-1-3-0	EMSK3-1-3-X
EMSK3-1-X0	EMSK3-1-C0
EMSK12-4-12-X0	EMSK12-4-12-C0
<b>F</b>	
FCBI1-S10-C20	FCBI1-S10-M20
FCBI2-S10-C20	FCBI2-S10-M20
FCBI3-S10-C20	FCBI3-S10-M20
FCC5-A-C8	FCC5-A-D8
FCC-A-C8	FCC-A-D8
FCH2-A-C14	FCH2-A-T14
FCM1-A-C14	FCM1-A-T14
FCM1-S6-C14	FCM1-S6-T14
FCM2-A-C14	FCM2-A-T14
FCM2-S6-C14	FCM2-S6-T14
FCM1.2-A-C14	FCM1.2-A-T14
FCM1.2-S6-C14	FCM1.2-S6-T14
FCM3.25-A-L14	FCM3.25-A-T14
FCM3.25-S6-L14	FCM3.25-S6-T14
FCPI1-C20	FCPI1-M20
FCPI2-C20	FCPI2-M20
FCPI3-C20	FCPI3-M20
<b>H</b>	
HCME06A12-C130	HCME06A12-M130
HCMP06B12-C20	HCMP06B12-M20
HCMP06C12-C20	HCMP06C12-M20
HWS2819-C	HWS2819-M
<b>K</b>	
KIMS-H366-C2	KIMS-H366-M2
KIMS-H430-C6	KIMS-H430-M6
KIMS-H500-C4	KIMS-H500-M4
<b>L</b>	
LPFCM14-A-C14	LPFCM14-A-D14
LPFCM22-A-C14	LPFCM22-A-D14
LPFCM34-A-C14	LPFCM34-A-D14
LPMM-S2-C	LPMM-S2-M
LPMM-S5-C	LPMM-S5-M
LPMS-S8-C	LPMS-S8-M
LWC19-A-C	LWC19-A-M
LWC19-A-C14	LWC19-A-M14
LWC19-H25-C	LWC19-H25-M
LWC19-H25-C14	LWC19-H25-M14
LWC25-A-C	LWC25-A-D
LWC25-A-C14	LWC25-A-D14
LWC25-H25-C	LWC25-H25-D
LWC25-H25-C14	LWC25-H25-D14
LWC38-A-C	LWC38-A-D
LWC38-A-C14	LWC38-A-D14
LWC38-H25-C	LWC38-H25-D
LWC38-H25-C14	LWC38-H25-D14
LWC50-A-L	LWC50-A-T
LWC50-A-L14	LWC50-A-T14
LWC50-H25-L	LWC50-H25-T
LWC50-H25-L14	LWC50-H25-T14
LWC75-A-L	LWC75-A-C
LWC75-A-L14	LWC75-A-C14

**Bulk Package Part Numbers (continued)**

The following is an alpha-numeric cross reference of Standard Package Wiring Accessories parts with the corresponding Bulk Package part numbers.

Standard Part No.	Bulk Part No.
LWC75-H25-L	LWC75-H25-C
LWC75-H25-L14	LWC75-H25-C14
LWC100-A-L	LWC100-A-C
LWC100-A-L14	LWC100-A-C14
LWC100-H25-L	LWC100-H25-C
LWC100-H25-L14	LWC100-H25-C14
<b>M</b>	
MBMS-S10-C	MBMS-S10-M
MMS8	STD. ONLY
MP150-C	MP150-M
THRU	THRU
MP350-C	MP350-M
MP150-C0	MP150-M0
THRU	THRU
MP350-C0	MP350-M0
BULK ONLY	MP150R
	THRU
	MP250R
MPMS19-C0	MPMS19-M0
MPMH38-L0	MPMH38-D0
MPMS25-C0	MPMS25-M0
MPMWH32-L0	MPMWH32-D0
<b>P</b>	
PBMS-H25-C	PBMS-H25-M
PBMS-H25-C14	PBMS-H25-M14
PC038-H25D-C0	PC038-H25D-D0
PC050-H25D-C0	PC050-H25D-D0
PC062-H25D-C0	PC062-H25D-D0
PC075-H25D-C0	PC075-H25D-D0
PC087-H25D-C0	PC087-H25D-D0
PC100-H25D-C0	PC100-H25D-T0
PC112-H25D-C0	PC112-H25D-T0
PC125-H25D-C0	PC125-H25D-T0
PLA2S-A-Q	PLA2S-A-C
PMCC38H25-C	PMCC38H25-M
PM2H25-C	PM2H25-M
PP1S-S10-X	PP1S-S10-C
PP2S-S10-X	PP2S-S10-C
PP2S-S12-X	PP2S-S12-C
PRA2S-A-Q	PRA2S-A-C
PWMS-H25-C	PWMS-H25-M
<b>R</b>	
RAFCBI1-S6-C20	RAFCBI1-S6-M20
RAFCBI2-S6-C20	RAFCBI2-S6-M20
RAFCBI3-S6-C20	RAFCBI3-S6-M20
<b>S</b>	
SICH25-C	SICH25-M
SICH38-C	SICH38-M
SICH50-C	SICH50-M
SICH75-C	SICH75-M
SMS-A-C	SMS-A-D

Standard Part No.	Bulk Part No.
<b>T</b>	
TA1S8-C	TA1S8-M
TA1S10-C	TA1S10-M
TA2-C	TA2-M
THASS8-C	THASS8-M
THASS8-C30	THASS-M30
THASS10-C	THASS10-M
THASS10F-C30	THASS10F-M30
THASS25-C	THASS25-M
THASS25-C30	THASS25-M30
THASS8F-C	THASS8F-M
THASS8F-C30	THASS8F-M30
THASS10F-C	THASS10F-M
THASS10F-C30	THASS10F-M30
THASS25F-C	THASS25F-M
THASS25F-C30	THASS25F-M30
THAUF4-X	THAUF4-C
THM1SC-C	THM1SC-M
THM1SC-C30	THM1SC-M30
THMSC35-C30	THMSC35-M30
THMSC35-C639	THMSC35-M639
THMSC35-C630	THMSC35-M630
THMSC35F-C630	THMSC35F-M630
THMSC35F-C39	THMSC35-M39
THMSC35F-C639	THMSC35-M639
THMSC60-C30	THMSC60-M30
THMSC60-C39	THMSC60-M39
THMSC60F-C30	THMSC60F-M30
THMSC60F-C39	THMSC60F-M39
THMSC85-C30	THMSC85-M30
THMSC85-C39	THMSC85-M39
THMSP25-C	THMSP25-M
THMSP25-C30	THMSP25-M30
THMSP25F-C30	THMSP25F-M30
TMEH-S8-Q0	TMEH-S8-C0
TMEH-S10-Q0	TMEH-S10-C0
TMEH-S25-Q0	TMEH-S25-C0
TMSH50-C300	TMSH50-T300
TMSTHS10-C0	TMSTHS10-D0
TMSTHS13-C0	TMSTHS13-D0
TMSTHS16-C0	TMSTHS16-D0
TMSTHS19-C0	TMSTHS16-D0
TMSTLHS5-C0	TMSTLHS5-M0
TMSTLHS6-C0	TMSTLHS6-M0
TMSTLHS8-C0	TMSTLHS8-M0
TM1A-C	TM1A-M
TM1S4-C	TM1S4-M
TM1S6-C	TM1S6-M
TM2A-C	TM2A-M
TM2PWH25-C	TM2PWH25-M
TM2R6-C	TM2R6-M
TM2S6-C	TM2S6-M

Standard Part No.	Bulk Part No.
TM2S8-C	TM2S8-M
TM2S8-C100	TM2S8-M100
TM3A-C	TM3A-M
TM3R6-C	TM3R6-M
TM3S10-C	TM3S10-M
TM3S25-C	TM3S25-M
TM3S8-C	TM3S8-M
TM3S8-C100	TM3S8-M100
TP2-C	TP2-M
TP4H-C	TP4H-D
TWR-C	TWR-M
<b>V</b>	
VCC25-A-C	VCC25-A-M
VCC50-A-C	VCC50-A-T
VCS-25-L	VCS-25-D
VCS-25-L100	VCS-25-D100
VWS106-C	VWS106-M
VWS106-C20	VWS106-M20
VWS4218-C	VWS4218-M
VWS4238-C	VWS4238-M
VWS4274-C	VWS4274-M
VWS42105-C	VWS42105-M
VWSDC-C	VWSDC-D
<b>W</b>	
WS75-25-C	WS75-25-M
WS75-50-C	WS75-50-M
WS75-75-C	WS75-75-M

**Heat Shrink**



**PVC Non-Shrink Tubing**



**Spiral Wrap**



**Grommet Edging**

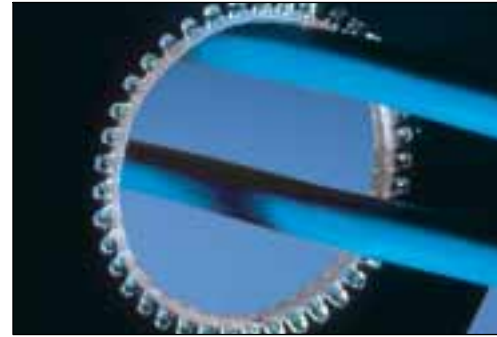

**Corrugated Loom Tubing**



**Braided Sleeving**



**Split Harness Wrap**



*Abrasion Protection for Wire, Cable, Hydraulic and Pneumatic Tubing*

---

**PANDUIT® Heat Shrink Tubing — Heat Shrink Tubing Quick Selection Guide**

Quick reference for PANDUIT® Heat Shrinking for specific location applications

CHARACTERISTICS	DRY SHRINK. HEAT SHRINK			DAMP SHRINK. HEAT SHRINK			WET SHRINK. HEAT SHRINK			
	HSTT	HSTTV	HSTTN	HSTTK	HSTTT	HSTTP	HSTTVA	HSTTRA	HSTTA	HST
U.L. Listed										X
UL Recognized	X‡	X			X		X			
CSA Certified	X‡✓	X✓					X✓			X**
VW-1 Rated		X			X		X			
Very Flexible		X	X							
Flexible	X						X	X		X
Semi-Rigid					X	X			X	X
Thin Wall	X	X	X	X	X	X	X	X	X	X
Thick Wall										X
Cross-Linked Material	X	X	X	X			X	X	X	X
Colors Available	X	X								X*
High Shrink Ratio									2.5:1	3:1
Flame Retardant	X‡	X	X	X	X	X	X	X	X	X
Adhesive Lined (Dual Wall)								X	X	X
Meets Military Specification	X	X	X	X	X			X	X	X
Below Ground Application										X
High Temp Applications(>250°F)					X	X				
Highly Chemical Resistant					X	X				
Low Coefficient of Friction						X				
Custom Cut Lengths	X	X	X	X	X	X	X	X	X	X
Standard 6" pieces	X	X						X		X
Standard 4' lengths	X	X			X	X		X	X	X
Small 25' Reels	X	X	X				X			
Large Reels	X	X	X				X			
IP Rating	62	62	62	62	—	62	66	66	66	68
Found on Page...	141-144	145-146	148	150	149	147	151	153	152	154

\*Black/Red  
 \*\*Except red  
 ‡Except clear  
 ✓Except sizes over 1"

See page 160 for IP Technical information.

**Thin Wall Heat Shrink Part Number System**

**HSTT 12 - 48 - Q 10**

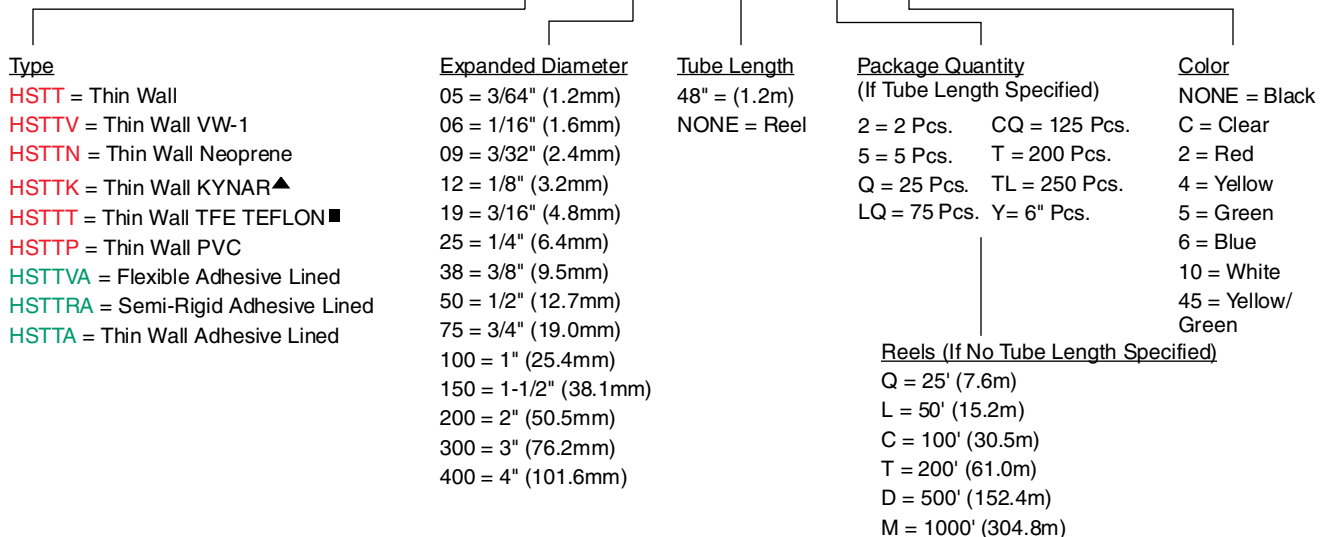





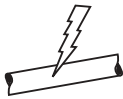
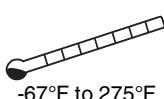

# PANDUIT® Flexible Polyolefin **DRY-SHRINK™** Heat Shrink Tubing

## HSTT Heat Shrink in 4' (1.2m) Pieces and Reels

- General purpose heat shrink tubing for dry locations
- Applications include insulating, protecting, harnessing and identifying wires



Type	Materials		
HSTT	Polyolefin Cross-Linked		
 600V	 -67°F to 275°F (-55°C to 135°C‡)	 AMS-DTL-23053/5 Class 1 or Class 2	 (Except Clear)
 Flexible	 Shrink Ratio: ▲ 2:1	 Flame Retardant (Except Clear)	 Variety of Colors

‡Maximum UL temperature range is 125°C

## HSTT in Bulk Packages — Large Reels and 4' (1.2m) Pcs. (3/64" to 3/16" Expanded I.D.)

Part Number (Black✓)	Nominal Diameter in.	Minimum Expanded I.D. in. (mm)	Maximum Recovered I.D. in. (mm)	Nominal Recovered Wall Thickness in. (mm)	Length Feet (m)	Bulk Pkg. Qty.*	Bulk Ctn. Qty.
<b>HSTT05-48-Q</b> HSTT05-48-TL HSTT05-C HSTT05-M	3/64	.046 (1.2)	.023 (0.6)	.016 (0.4)	4 (1.2) 4 (1.2) 100 (30.5) 1000 (304.8)	25 Pcs. 250 Pcs. 1 Reel 1 Reel	— — 10 Reels 2 Reels
<b>HSTT06-48-Q</b> HSTT06-48-TL HSTT06-C HSTT06-M	1/16	.063 (1.6)	.031 (0.8)	.017 (0.4)	4 (1.2) 4 (1.2) 100 (30.5) 1000 (304.8)	25 Pcs. 250 Pcs. 1 Reel 1 Reel	— — 10 Reels 2 Reels
<b>HSTT09-48-Q</b> HSTT09-48-TL HSTT09-C HSTT09-M	3/32	.093 (2.4)	.046 (1.2)	.020 (0.5)	4 (1.2) 4 (1.2) 100 (30.5) 1000 (304.8)	25 Pcs. 250 Pcs. 1 Reel 1 Reel	— — 10 Reels 2 Reels
<b>HSTT12-48-Q</b> HSTT12-48-TL HSTT12-C HSTT12-M	1/8	.125 (3.2)	.062 (1.6)	.020 (0.5)	4 (1.2) 4 (1.2) 100 (30.5) 1000 (304.8)	25 Pcs. 250 Pcs. 1 Reel 1 Reel	— — 10 Reels 2 Reels
<b>HSTT19-48-Q</b> HSTT19-48-TL HSTT19-C HSTT19-M	3/16	.187 (4.8)	.093 (2.4)	.020 (0.5)	4 (1.2) 4 (1.2) 100 (30.5) 1000 (304.8)	25 Pcs. 250 Pcs. 1 Reel 1 Reel	— — 10 Reels 2 Reels

\*Order in multiples of bulk pkg. qty.  
See page 160 for IP Technical Information.

✓For additional color information, contact PANDUIT® Technical Assistance 866-405-6657.

▲Shrink ratios are approximations; please refer to above ordering information for the exact min. Expanded and max. recovered I.D.'s.

# PANDUIT® Flexible Polyolefin *DRY-SHRINK™* Heat Shrink Tubing

## HSTT in Bulk Packages (cont.) — Large Reels and 4'(1.2m) Pcs. (1/4" to 3/4" Expanded I.D.)

Part Number (Black✓)	Nominal Diameter in.	Minimum Expanded I.D. in. (mm)	Maximum Recovered I.D. in. (mm)	Nominal Recovered Wall Thickness in. (mm)	Length Feet (m)	Bulk Pkg. Qty.*	Bulk Ctn. Qty.
<b>HSTT25-48-Q</b> HSTT25-48-TL <b>HSTT25-C</b> HSTT25-D	1/4	.250 (6.4)	.125 (3.2)	.025 (0.6)	4 (1.2) 4 (1.2) 100 (30.5) 500 (152.4)	25 Pcs. 250 Pcs. 1 Reel 1 Reel	— — 10 Reels 2 Reels
<b>HSTT38-48-Q</b> HSTT38-48-TL <b>HSTT38-C</b> HSTT38-T	3/8	.375 (9.5)	.187 (4.8)	.025 (0.6)	4 (1.2) 4 (1.2) 100 (30.5) 200 (61.0)	25 Pcs. 250 Pcs. 1 Reel 1 Reel	— — 10 Reels 2 Reels
<b>HSTT50-48-Q</b> HSTT50-48-T <b>HSTT50-C</b> HSTT50-T	1/2	.500 (12.7)	.250 (6.4)	.025 (0.6)	4 (1.2) 4 (1.2) 100 (30.5) 200 (61.0)	25 Pcs. 200 Pcs. 1 Reel 1 Reel	— — 10 Reels 2 Reels
<b>HSTT75-48-5</b> HSTT75-48-CQ <b>HSTT75-C</b> HSTT75-T	3/4	.750 (19.0)	.375 (9.5)	.030 (0.8)	4 (1.2) 4 (1.2) 100 (30.5) 200 (61.0)	5 Pcs. 125 Pcs. 1 Reel 1 Reel	— — 10 Reels 2 Reels

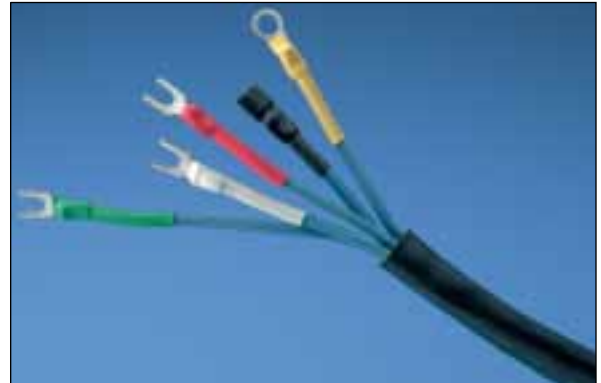

## HSTT in Bulk Packages — Large Reels and 4' (1.2m) Pcs. (1" to 4" Expanded I.D.)

Part Number (Black✓)	Nominal Diameter in.	Minimum Expanded I.D. in. (mm)	Maximum Recovered I.D. in. (mm)	Nominal Recovered Wall Thickness in. (mm)	Length Feet (m)	Bulk Pkg. Qty.*	Bulk Ctn. Qty.
<b>HSTT100-48-5</b> HSTT100-48-LQ <b>HSTT100-C</b>	1	1.00 (25.4)	.500 (12.7)	.035 (0.9)	4 (1.2) 4 (1.2) 100 (30.5)	5 Pcs. 75 Pcs. 1 Reel	— — 2 Reels
<b>HSTT150-48-5</b> <b>HSTT150-C</b>	1 1/2	1.50 (38.1)	.750 (19.0)	.040 (1.0)	4 (1.2) 100 (30.5)	5 Pcs. 1 Reel	— 2 Reels
<b>HSTT200-48-5</b> <b>HSTT200-L</b>	2	2.00 (50.8)	1.00 (25.4)	.045 (1.1)	4 (1.2) 50 (15.2)	5 Pcs. 1 Reel	— 2 Reels
HSTT300-48-2 HSTT300-L	3	3.00 (76.2)	1.50 (38.1)	.050 (1.3)	4 (1.2) 50 (15.2)	2 Pcs. 1 Reel	— —
<b>HSTT400-48-2</b> HSTT400-L	4	4.00 (101.6)	2.00 (50.8)	.055 (1.4)	4 (1.2) 50 (15.2)	2 Pcs. 1 Reel	— —

## HSTT Heat Shrink on 25' (7.6m) Reels

- General purpose heat shrink tubing for dry locations
- Featuring unique self dispensing Q-Box 25' (7.5m)

### HSTT in Standard Packages

Part Number (Black✓)	Nominal Diameter in.	Minimum Expanded I.D. in. (mm)	Maximum Recovered I.D. in. (mm)	Nominal Recovered Wall Thickness in. (mm)	Length Feet (m)	Std. Pkg. Qty.*	Std. Ctn. Qty.
<b>HSTT05-Q</b>	3/64	.046 (1.2)	0.23 (0.6)	.016 (0.4)	25 (7.6)	1 Reel	10 Reels
<b>HSTT06-Q</b>	1/16	.063 (1.6)	.031 (0.8)	.017 (0.4)	25 (7.6)	1 Reel	10 Reels
<b>HSTT09-Q</b>	3/32	.093 (2.4)	.046 (1.2)	.020 (0.5)	25 (7.6)	1 Reel	10 Reels
<b>HSTT12-Q</b>	1/8	.125 (3.2)	.062 (1.6)	.020 (0.5)	25 (7.6)	1 Reel	10 Reels
<b>HSTT19-Q</b>	3/16	.187 (4.8)	.093 (2.4)	.020 (0.5)	25 (7.6)	1 Reel	10 Reels
<b>HSTT25-Q</b>	1/4	.250 (6.4)	.125 (3.2)	.025 (0.6)	25 (7.6)	1 Reel	10 Reels
<b>HSTT38-Q</b>	3/8	.375 (9.5)	.187 (4.8)	.025 (0.6)	25 (7.6)	1 Reel	10 Reels
<b>HSTT50-Q</b>	1/2	.500 (12.7)	.250 (6.4)	.025 (0.6)	25 (7.6)	1 Reel	10 Reels
<b>HSTT75-Q</b>	3/4	.750 (19.0)	.375 (9.5)	.030 (0.8)	25 (7.6)	1 Reel	10 Reels

## HSTT Heat Shrink Standard Packs of Heat Shrink — 6" (152.4mm) Pieces



Small package holds unused tube and fits easily in a tool box

- General purpose heat shrink tubing for dry locations
- Applications include insulating, protecting, harnessing and identifying wires



### HSTT in Standard Packages

Part Number (Black✓)	Nominal Diameter in.	Minimum Expanded I.D. in. (mm)	Maximum Recovered I.D. in. (mm)	Nominal Recovered Wall Thickness in. (mm)	Length in. (mm)	Std. Pkg. Qty.*	Std. Ctn. Qty.
<b>HSTT06-Y</b>	1/16	.063 (1.6)	.031 (0.8)	.017 (0.4)	6 (152.4)	26 pcs.	10 Pkgs.
<b>HSTT09-Y</b>	3/32	.093 (2.4)	.046 (1.2)	.020 (0.5)	6 (152.4)	24 pcs.	10 Pkgs.
<b>HSTT12-Y</b>	1/8	.125 (3.2)	.062 (1.6)	.020 (0.5)	6 (152.4)	20 pcs.	10 Pkgs.
<b>HSTT19-Y</b>	3/16	.187 (4.8)	.093 (2.4)	.020 (0.5)	6 (152.4)	18 pcs.	10 Pkgs.
<b>HSTT25-Y</b>	1/4	.250 (6.4)	.125 (3.2)	.025 (0.6)	6 (152.4)	14 pcs.	10 Pkgs.
<b>HSTT38-Y</b>	3/8	.375 (9.5)	.187 (4.8)	.025 (0.6)	6 (152.4)	12 pcs.	10 Pkgs.
<b>HSTT50-Y</b>	1/2	.500 (12.7)	.250 (6.4)	.025 (0.6)	6 (152.4)	10 pcs.	10 Pkgs.
<b>HSTT75-Y</b>	3/4	.750 (19.0)	.375 (9.5)	.030 (0.8)	6 (152.4)	8 pcs.	10 Pkgs.
<b>HSTT100-Y</b>	1	1.00 (25.4)	.500 (12.7)	.035 (0.9)	6 (152.4)	6 pcs.	10 Pkgs.

\*Order in multiples of std. pkg. qty.

✓For additional color information, contact PANDUIT® Technical Assistance 866-405-6657.

▲Shrink ratios are approximations; please refer to above ordering information for the exact min. expanded and max. recovered I.D.'s.

# PANDUIT® Flexible Polyolefin *DRY-SHRINK™* Heat Shrink Tubing

## Standard Packs of Heat Shrink — 6" (152.4mm) Pieces

Small package holds unused tube and fits easily in a tool box

- Assorted colors and diameters available



## HSTT — Combination: Black and Colors — Single Diameter

Part Number	Nominal Diameter in.	Minimum Expanded I.D. in. (mm)	Maximum Recovered I.D. in. (mm)	Black No. Pcs.	Each Color No. Pcs.	Std. Pkg. Qty.*	Std. Ctn. Qty.
<b>HSTT06-YK1</b>	1/16	.063 (1.6)	.031 (0.8)	8	3	26 pcs.	10 Pkgs.
<b>HSTT09-YK1</b>	3/32	.093 (2.4)	.046 (1.2)	6	3	24 pcs.	10 Pkgs.
<b>HSTT12-YK1</b>	1/8	.125 (3.2)	.062 (1.6)	2	3	20 pcs.	10 Pkgs.
<b>HSTT19-YK1</b>	3/16	.187 (4.8)	.093 (2.4)	6	2	18 pcs.	10 Pkgs.
<b>HSTT25-YK1</b>	1/4	.250 (6.4)	.125 (3.2)	2	2	14 pcs.	10 Pkgs.
<b>HSTT38-YK1</b>	3/8	.375 (9.5)	.187 (4.8)	6	1	12 pcs.	10 Pkgs.
<b>HSTT50-YK1</b>	1/2	.500 (12.7)	.250 (6.4)	4	1	10 pcs.	10 Pkgs.
<b>HSTT75-YK1</b>	3/4	.750 (19.0)	.375 (9.5)	2	1	8 pcs.	10 Pkgs.
<b>HSTT100-YK1</b>	1	1.00 (25.4)	.500 (12.7)	1	1	7 pcs.	10 Pkgs.

NOTE: Colors include clear, red, yellow, green, blue and white. For additional color information, contact PANDUIT® Technical Assistance 866-405-6657.

## HSTT — Black Only — Multiple Diameters

Part Number	Nominal Diameter	Black Number of Pieces by Diameter	Std. Pkg. Qty.*	Std. Ctn. Qty.
<b>HSTT-YK1</b>	Various; Smaller Range	(2) pcs. each 1/8", 1/16", 3/16", 3/32", 1/4", 1/2", 3/8"	14 pcs.	10 Pkgs.
<b>HSTT-YK2</b>	Various; Larger Range	(2) pcs. each 3/8", 1/2", 3/4", 1"	8 pcs.	10 Pkgs.



## HSTT — Yellow/Green Stripe — Multiple Diameters

Part Number	Nominal Diameter	Number of Pieces by Diameter	Std. Pkg. Qty.*	Std. Ctn. Qty.
<b>HSTT-YK1-45</b>	Various; Smaller Range	(2) pcs. each 1/8", 3/16", 1/4", 3/8"	8 pcs.	10 Pkgs.
<b>HSTT-YK2-45</b>	Various; Larger Range	(2) pcs. each 3/8", 1/2", 3/4"	6 pcs.	10 Pkgs.







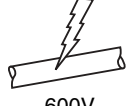
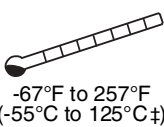
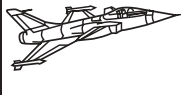

**HSTTV Heat Shrink in Small Reels and 4' (1.2m) Pieces**

- For dry locations
- Highly flame retardant
- Meets UL VW-1 rating
- Fast Shrink Time

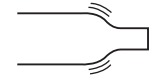

Type	Materials		
HSTTV	 Polyolefin Cross-Linked		
 600V	 -67°F to 257°F (-55°C to 125°C‡)	 AMS-DTL-23053/5 Class 3	 VW-1 OFT
 Flexible	 Shrink Ratio:▲ 2:1	 Highly Flame Retardant VW-1	



‡Maximum UL temperature range is 125° C.

**HSTTV in Bulk Packages — Small Reels & 4' (1.2m) Pcs.**

Part Number (Black✓)	Nominal Diameter in.	Minimum Expanded I.D. in. (mm)	Maximum Recovered I.D. in. (mm)	Nominal Recovered Wall Thickness in. (mm)	Length Feet (m)	Bulk Pkg. Qty.*	Bulk Ctn. Qty.
<b>HSTTV05-48-Q</b>	3/64	.046 (1.2)	.023 (0.6)	.016 (0.4)	4 (1.2)	25 Pcs.	—
<b>HSTTV05-48-TL</b>					4 (1.2)	250 Pcs.	—
<b>HSTTV05-C</b>					100 (30.5)	1 Reel	10 Reels
<b>HSTTV06-48-Q</b>	1/16	.063 (1.6)	.031 (0.8)	.017 (0.4)	4 (1.2)	25 Pcs.	—
<b>HSTTV06-48-TL</b>					4 (1.2)	250 Pcs.	—
<b>HSTTV06-C</b>					100 (30.5)	1 Reel	10 Reels
<b>HSTTV09-48-Q</b>	3/32	.093 (2.4)	.046 (1.2)	.020 (0.5)	4 (1.2)	25 Pcs.	—
<b>HSTTV09-48-TL</b>					4 (1.2)	250 Pcs.	—
<b>HSTTV09-C</b>					100 (30.5)	1 Reel	10 Reels
<b>HSTTV12-48-Q</b>	1/8	.125 (3.2)	.062 (1.6)	.020 (0.5)	4 (1.2)	25 Pcs.	—
<b>HSTTV12-48-TL</b>					4 (1.2)	250 Pcs.	—
<b>HSTTV12-C</b>					100 (30.5)	1 Reel	10 Reels
<b>HSTTV19-48-Q</b>	3/16	.187 (4.8)	.093 (2.4)	.020 (0.5)	4 (1.2)	25 Pcs.	—
<b>HSTTV19-48-TL</b>					4 (1.2)	250 Pcs.	—
<b>HSTTV19-C</b>					100 (30.5)	1 Reel	10 Reels
<b>HSTTV25-48-Q</b>	1/4	.250 (6.4)	.125 (3.2)	.025 (0.6)	4 (1.2)	25 Pcs.	—
<b>HSTTV25-48-TL</b>					4 (1.2)	250 Pcs.	—
<b>HSTTV25-C</b>					100 (30.5)	1 Reel	10 Reels
<b>HSTTV38-48-Q</b>	3/8	.375 (9.5)	.187 (4.8)	.025 (0.6)	4 (1.2)	25 Pcs.	—
<b>HSTTV38-48-TL</b>					4 (1.2)	250 Pcs.	—
<b>HSTTV38-C</b>					100 (30.5)	1 Reel	10 Reels
<b>HSTTV50-48-Q</b>	1/2	.500 (12.7)	.250 (6.4)	.025 (0.6)	4 (1.2)	25 Pcs.	—
<b>HSTTV50-48-T</b>					4 (1.2)	200 Pcs.	—
<b>HSTTV50-C</b>					100 (30.5)	1 Reel	10 Reels
<b>HSTTV75-48-5</b>	3/4	.750 (19.0)	.375 (9.5)	.030 (0.8)	4 (1.2)	5 Pcs.	—
<b>HSTTV75-48-CQ</b>					4 (1.2)	125 Pcs.	—
<b>HSTTV75-C</b>					100 (30.5)	1 Reel	10 Reels
<b>HSTTV100-48-5</b>	1	1.00 (25.4)	.500 (12.7)	.035 (0.9)	4 (1.2)	5 Pcs.	—
<b>HSTTV100-48-LQ</b>					4 (1.2)	75 Pcs.	—
<b>HSTTV100-C</b>					100 (30.5)	1 Reel	2 Reels
<b>HSTTV150-48-5</b>	1 1/2	1.50 (38.1)	.750 (19.0)	.040 (1.0)	4 (1.2)	5 Pcs.	—
<b>HSTTV150-C</b>					100 (30.5)	1 Reel	2 Reels

\*Order in multiples of bulk pkg. qty.

✓ For additional color information, contact PANDUIT® Technical Assistance 866-405-6657.

▲ Shrink ratios are approximations; please refer to above ordering information for the exact min. expanded and max. recovered I.D.s.

# PANDUIT® Flexible Polyolefin VW-1 *DRY-SHRINK™* Heat Shrink Tubing

## HSTTV Heat Shrink in 1000' (304.8m), 500' (152.4m) and 200' (61.0m) Reels

### HSTTV in Bulk Packages — Large Reels

Nominal Diameter in.	Length Feet (m)	Part Number				Bulk Pkg. Qty.*	Bulk Ctn. Qty.
		Black	Red	Yellow	Blue		
3/64	1000 (304.8)	HSTTV05-M	HSTTV05-M2	HSTTV05-M4	HSTTV05-M6	1 Reel	2 Reels
1/16	1000 (304.8)	HSTTV06-M	HSTTV06-M2	HSTTV06-M4	HSTTV06-M6	1 Reel	2 Reels
3/32	1000 (304.8)	HSTTV09-M	HSTTV09-M2	HSTTV09-M4	HSTTV09-M6	1 Reel	2 Reels
1/8	1000 (304.8)	HSTTV12-M	HSTTV12-M2	HSTTV12-M4	HSTTV12-M6	1 Reel	2 Reels
3/16	1000 (304.8)	HSTTV19-M	HSTTV19-M2	HSTTV19-M4	HSTTV19-M6	1 Reel	2 Reels
1/4	500 (152.4)	<b>HSTTV25-D</b>	HSTTV25-D2	HSTTV25-D4	HSTTV25-D6	1 Reel	2 Reels
3/8	200 (61.0)	<b>HSTTV38-T</b>	HSTTV38-T2	HSTTV38-T4	HSTTV38-T6	1 Reel	2 Reels
1/2	200 (61.0)	<b>HSTTV50-T</b>	HSTTV50-T2	HSTTV50-T4	HSTTV50-T6	1 Reel	2 Reels
3/4	200 (61.0)	<b>HSTTV75-T</b>	HSTTV75-T2	HSTTV75-T4	HSTTV75-T6	1 Reel	2 Reels

\* Order in multiples of bulk pkg. qty.

## HSTTV Heat Shrink in 25' (7.5m) Reels



### HSTTV in Standard Packages of 25' (7.5m) Reels — Black Only

Part Number	Nominal Diameter in.	Minimum Expanded I.D. in. (mm)	Maximum Recovered I.D. in. (mm)	Nominal Recovered Wall Thickness in. (mm)	Length Feet (m)	Std. Pkg. Qty.*	Std. Ctn. Qty.
HSTTV05-Q	3/64	.046 (1.2)	.023 (0.6)	.020 (0.5)	25 (7.5)	1 Reel	10 Reels
HSTTV06-Q	1/16	.063 (1.6)	.031 (0.8)	.020 (0.5)	25 (7.5)	1 Reel	10 Reels
HSTTV09-Q	3/32	.093 (2.4)	.046 (1.2)	.020 (0.5)	25 (7.5)	1 Reel	10 Reels
HSTTV12-Q	1/8	.125 (3.2)	.062 (1.6)	.020 (0.5)	25 (7.5)	1 Reel	10 Reels
HSTTV19-Q	3/16	.187 (4.8)	.093 (2.4)	.020 (0.5)	25 (7.5)	1 Reel	10 Reels
<b>HSTTV25-Q</b>	1/4	.250 (6.4)	.125 (3.2)	.025 (0.6)	25 (7.5)	1 Reel	10 Reels
HSTTV38-Q	3/8	.375 (9.5)	.187 (4.8)	.025 (0.6)	25 (7.5)	1 Reel	10 Reels
<b>HSTTV50-Q</b>	1/2	.500 (12.7)	.250 (6.4)	.025 (0.6)	25 (7.5)	1 Reel	10 Reels
HSTTV75-Q	3/4	.750 (19.0)	.375 (9.5)	.030 (0.8)	25 (7.5)	1 Reel	10 Reels
HSTTV100-Q	1	1.00 (25.4)	.500 (12.7)	.035 (0.9)	25 (7.5)	1 Reel	2 Reels

\* Order in multiples of std. pkg. qty.

## Standard Packs of Heat Shrink — 6" (152.4mm) Pieces



### HSTTV — Single Diameter — Black Only

Part Number	Nominal Diameter in.	Minimum Expanded I.D. in. (mm)	Maximum Recovered I.D. in. (mm)	Std. Pkg. Qty.*	Std. Ctn. Qty.
HSTTV05-Y	3/64	.046 (1.2)	.023 (0.6)	26 pcs.	10 Pkgs.
HSTTV06-Y	1/16	.063 (1.6)	.031 (0.8)	26 pcs.	10 Pkgs.
HSTTV09-Y	3/32	.093 (2.4)	.046 (1.2)	24 pcs.	10 Pkgs.
HSTTV12-Y	1/8	.125 (3.2)	.062 (1.6)	20 pcs.	10 Pkgs.
HSTTV19-Y	3/16	.187 (4.8)	.093 (2.4)	18 pcs.	10 Pkgs.
HSTTV25-Y	1/4	.250 (6.4)	.125 (3.2)	14 pcs.	10 Pkgs.
HSTTV38-Y	3/8	.375 (9.5)	.187 (4.8)	12 pcs.	10 Pkgs.
HSTTV50-Y	1/2	.500 (12.7)	.250 (6.4)	10 pcs.	10 Pkgs.
HSTTV75-Y	3/4	.750 (19.0)	.375 (9.5)	8 pcs.	10 Pkgs.
HSTTV100-Y	1	1.00 (25.4)	.500 (12.7)	6 pcs.	10 Pkgs.

\* Order in multiples of std. pkg. qty.

**HSTTP Heat Shrink**

- For dry locations
- Flexible, highly flame retardant tubing
- Good resistance to most fuels and oils
- Good cut through and solder resistance
- Material is UV Resistant



Type	Materials	
HSTTP	Polyvinyl Chloride Cross-Linked	
 600V	 -4°F to 221°F (-20°C to 105°C)	
 Flexible	 Shrink Ratio:▲ 2:1	 Highly Flame Retardant VW-1



**HSTTP in Standard Packages — Reels — Black Only**

Part Number	Nominal Diameter in.	Minimum Expanded I.D. in. (mm)	Maximum Recovered I.D. in. (mm)	Nominal Recovered Wall Thickness in. (mm)	Length Feet (m)	Std. Pkg. Qty.*	Std. Ctn. Qty.
<b>HSTTP05-Q</b> HSTTP05-C HSTTP05-M	3/64	.046 (1.2)	.023 (0.6)	.020 (0.5)	25 (7.5) 100 (30.5) 1000 (304.8)	1 Reel 1 Reel 1 Reel	10 Reels 2 Reels 2 Reels
<b>HSTTP06-Q</b> <b>HSTTP06-C</b> HSTTP06-M	1/16	.063 (1.6)	.031 (0.8)	.020 (0.5)	25 (7.5) 100 (30.5) 1000 (304.8)	1 Reel 1 Reel 1 Reel	10 Reels 2 Reels 2 Reels
<b>HSTTP09-Q</b> HSTTP09-C HSTTP09-M	3/32	.093 (2.4)	.046 (1.2)	.025 (0.6)	25 (7.5) 100 (30.5) 1000 (304.8)	1 Reel 1 Reel 1 Reel	10 Reels 2 Reels 2 Reels
<b>HSTTP12-Q</b> <b>HSTTP12-C</b> HSTTP12-M	1/8	.125 (3.2)	.062 (1.6)	.025 (0.6)	25 (7.5) 100 (30.5) 1000 (304.8)	1 Reel 1 Reel 1 Reel	10 Reels 2 Reels 2 Reels
<b>HSTTP19-Q</b> <b>HSTTP19-C</b> HSTTP19-M	3/16	.187 (4.8)	.093 (2.4)	.025 (0.6)	25 (7.5) 100 (30.5) 1000 (304.8)	1 Reel 1 Reel 1 Reel	10 Reels 2 Reels 2 Reels
<b>HSTTP25-Q</b> <b>HSTTP25-C</b> HSTTP25-D	1/4	.250 (6.4)	.125 (3.2)	.025 (0.6)	25 (7.5) 100 (30.5) 500 (152.4)	1 Reel 1 Reel 1 Reel	10 Reels 2 Reels 2 Reels
<b>HSTTP38-Q</b> <b>HSTTP38-C</b> HSTTP38-T	3/8	.375 (9.5)	.187 (4.8)	.030 (0.8)	25 (7.5) 100 (30.5) 200 (61.0)	1 Reel 1 Reel 1 Reel	10 Reels 2 Reels 2 Reels
<b>HSTTP50-Q</b> <b>HSTTP50-C</b>	1/2	.500 (12.7)	.250 (6.4)	.030 (0.8)	25 (7.5) 100 (30.5)	1 Reel 1 Reel	10 Reels 2 Reels
<b>HSTTP75-Q</b> HSTTP75-C	3/4	.750 (19.0)	.375 (9.5)	.035 (0.9)	25 (7.5) 100 (30.5)	1 Reel 1 Reel	10 Reels 2 Reels
<b>HSTTP100-Q</b> HSTTP100-C	1	1.00 (25.4)	.500 (12.7)	.040 (1.0)	25 (7.5) 100 (30.5)	1 Reel 1 Reel	2 Reels 2 Reels
<b>HSTTP150-Q</b> HSTTP150-C	1 1/2	1.50 (38.1)	.750 (19.0)	.045 (1.1)	25 (7.5) 100 (30.5)	1 Reel 1 Reel	2 Reels 2 Reels
<b>HSTTP200-Q</b>	2	2.00 (50.8)	1.00 (25.4)	.050 (1.3)	25 (7.5)	1 Reel	2 Reels

\*Order in multiples of std. pkg. qty.







▲Shrink ratios are approximations; please refer to above ordering information for the exact min. expanded and max. recovered I.D.'s.

# PANDUIT® Neoprene *DRY-SHRINK™* Heat Shrink Tubing

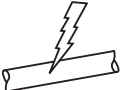
## HSTTN Heat Shrink

- For dry locations
- Highly flexible tubing
- Offers excellent chemical resistance, especially to fuels and oils
- Highly flame retardant



Type	Materials	
HSTTN	 <b>Elastomer Neoprene Cross-Linked</b>	
 600V	 -94°F to 250°F (-70°C to 121°C)	 AMS-DTL-23053/1 Class 2
 Highly Flexible	 Shrink Ratio:▲ 2:1	 Highly Flame Retardant



### HSTTN in Standard Packages — 25' (7.5m) and 100' (30.5m) Reels — Black Only

Part Number	Nominal Diameter in.	Minimum Expanded I.D. in. (mm)	Maximum Recovered I.D. in. (mm)	Nominal Recovered Wall Thickness in. (mm)	Length Feet (m)	Std. Pkg. Qty.*	Std. Ctn. Qty.
HSTTN25-C	1/4	.250 (6.4)	.143 (3.6)	.035 (0.9)	100 (30.5)	1 Reel	2 Reels
HSTTN38-C	3/8	.375 (9.5)	.211 (5.4)	.040 (1.0)	100 (30.5)	1 Reel	2 Reels
HSTTN50-C	1/2	.500 (12.7)	.286 (7.3)	.048 (1.2)	100 (30.5)	1 Reel	2 Reels
HSTTN63-C	5/8	.625 (15.9)	.357 (9.1)	.052 (1.3)	100 (30.5)	1 Reel	2 Reels
HSTTN75-C	3/4	.750 (19.0)	.428 (10.9)	.057 (1.5)	100 (30.5)	1 Reel	2 Reels
HSTTN88-C	7/8	.875 (22.2)	.500 (12.7)	.065 (1.7)	100 (30.5)	1 Reel	2 Reels
HSTTN100-C	1	1.00 (25.4)	.570 (14.5)	.070 (1.8)	100 (30.5)	1 Reel	2 Reels
HSTTN125-C	1 1/4	1.25 (31.8)	.714 (18.1)	.087 (2.2)	100 (30.5)	1 Reel	2 Reels
HSTTN150-C	1 1/2	1.50 (38.1)	.857 (21.8)	.095 (2.4)	100 (30.5)	1 Reel	2 Reels
HSTTN175-C	1 3/4	1.75 (44.5)	1.00 (25.4)	.107 (2.7)	100 (30.5)	1 Reel	2 Reels
HSTTN200-Q	2	2.00 (50.8)	1.140 (29.0)	.110 (2.8)	25 (7.5)	1 Reel	2 Reels
HSTTN300-Q	3	3.00 (76.2)	1.710 (43.4)	.125 (3.8)	25 (7.5)	1 Reel	2 Reels







# PANDUIT® TFE TEFLON‡ DRY-SHRINK™ Heat Shrink Tubing

## HSTTT (TFE) Heat Shrink

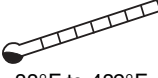

- For dry locations
- Semi-rigid, highly heat resistant
- Offers the widest temperature range of any plastic material
- Color is milky clear

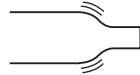
NOTE: Special instructions on [page 158](#).

Type	Materials	
HSTTT	 <b>Polytetrafluoroethylene</b>	
 600V	 -88°F to 482°F (-67°C to 250°C)	 AMS-DTL-23053/ 12, Class 3
 Semi-Rigid	 Shrink Ratio:▲ 2:1	 Non-Flammable

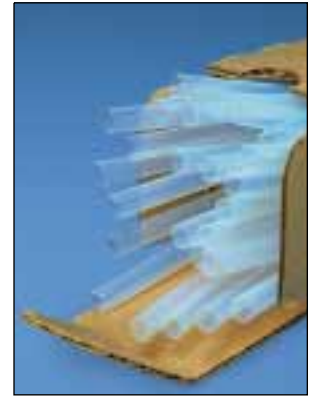

### 2:1 Shrink Ratio (Class 3) — HSTTT in Standard Packages — 4' (1.2m) Pcs.









Part Number	Nominal Diameter	Minimum Expanded I.D. in. (mm)	Maximum Recovered I.D. in. (mm)	Nominal Recovered Wall Thickness in. (mm)	Length Feet (m)	Std. Pkg. Qty.*
HSTTT03-48-Q	30 AWG	.034 (0.9)	.015 (0.4)	.009 (0.2)	4 (1.2)	25 Pcs.
HSTTT04-48-Q	28 AWG	.038 (1.0)	.018 (0.5)	.009 (0.2)	4 (1.2)	25 Pcs.
HSTTT046-48-Q	26 AWG	.046 (1.2)	.022 (0.5)	.010 (0.3)	4 (1.2)	25 Pcs.
HSTTT05-48-Q	24 AWG	.050 (1.3)	.027 (0.7)	.010 (0.3)	4 (1.2)	25 Pcs.
HSTTT055-48-Q	22 AWG	.055 (1.4)	.032 (0.8)	.012 (0.3)	4 (1.2)	25 Pcs.
HSTTT06-48-Q	20 AWG	.060 (1.5)	.039 (1.0)	.012 (0.3)	4 (1.2)	25 Pcs.
HSTTT08-48-Q	18 AWG	.076 (1.9)	.049 (1.2)	.012 (0.3)	4 (1.2)	25 Pcs.
HSTTT09-48-Q	16 AWG	.093 (2.3)	.061 (1.6)	.012 (0.3)	4 (1.2)	25 Pcs.
HSTTT12-48-Q	14 AWG	.120 (3.0)	.072 (1.8)	.012 (0.3)	4 (1.2)	25 Pcs.
HSTTT15-48-Q	12 AWG	.150 (3.8)	.089 (2.3)	.012 (0.3)	4 (1.2)	25 Pcs.
HSTTT19-48-Q	10 AWG	.191 (4.9)	.112 (2.8)	.012 (0.3)	4 (1.2)	25 Pcs.
HSTTT24-48-Q	8 AWG	.240 (6.0)	.141 (3.6)	.015 (0.4)	4 (1.2)	25 Pcs.
HSTTT30-48-Q	6 AWG	.302 (7.7)	.178 (4.5)	.015 (0.4)	4 (1.2)	25 Pcs.
HSTTT37-48-Q	4 AWG	.370 (9.4)	.224 (5.7)	.015 (0.4)	4 (1.2)	25 Pcs.
HSTTT43-48-Q	2 AWG	.430 (10.9)	.278 (7.0)	.015 (0.4)	4 (1.2)	25 Pcs.
HSTTT47-48-Q	0 AWG	.470 (11.9)	.347 (8.8)	.015 (0.4)	4 (1.2)	25 Pcs.
HSTTT56-48-5	9/16	.560 (14.2)	.399 (10.1)	.015 (0.4)	4 (1.2)	5 Pcs.
HSTTT66-48-5	5/8	.655 (16.6)	.462 (11.7)	.018 (0.5)	4 (1.2)	5 Pcs.
HSTTT75-48-5	3/4	.750 (19.0)	.524 (13.3)	.018 (0.5)	4 (1.2)	5 Pcs.
HSTTT93-48-5	15/16	.930 (23.6)	.655 (16.6)	.020 (0.5)	4 (1.2)	5 Pcs.
HSTTT112-48-5	1 1/8	1.125 (28.6)	.786 (20.0)	.025 (0.6)	4 (1.2)	5 Pcs.
HSTTT131-48-2	1 5/16	1.310 (33.3)	.911 (23.1)	.030 (0.8)	4 (1.2)	2 Pcs.
HSTTT150-48-2	1 1/2	1.500 (38.1)	1.036 (26.3)	.030 (0.8)	4 (1.2)	2 Pcs.

\*Order in multiples of std. pkg. qty.  
▲Shrink ratios are approximations; please refer to above ordering information for the exact min. expanded and max. recovered I.D.'s.  
‡TFEFLON is a registered trademark of E.I. DuPont de Nemours Co.

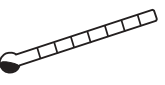
## HSTTK KYNAR<sup>®</sup> Heat Shrink

- For dry locations
- Semi-rigid, highly heat resistant
- Offers excellent chemical and abrasion resistance
- Use in high temperature or solvent rich environment
- Color is milky clear

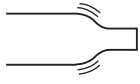

Type	Material		
HSTTK	 Polyvinylidene Fluoride		
 600V	 -67°F to 347°F (-55°C to 175°C)	 AMS-DTL-23053/8	 VW-1
 Semi-Rigid	 Shrink Ratio:▲ 2:1	 Highly Flame Retardant VW-1	

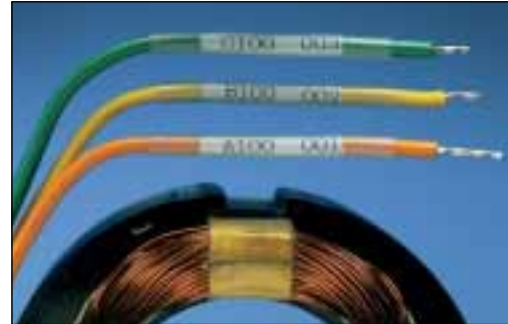







### HSTTK in Standard Packages — 4' (1.2m) Pieces

Part Number	Nominal Diameter in.	Minimum Expanded I.D. in. (mm)	Maximum Recovered I.D. in. (mm)	Nominal Recovered Wall Thickness in. (mm)	Length Feet (m)	Std. Pkg. Qty.*
HSTTK05-48-Q	3/64	.046 (1.2)	.023 (0.6)	.010 (0.3)	4 (1.2)	25 Pcs.
HSTTK06-48-Q	1/16	.063 (1.6)	.031 (0.8)	.010 (0.3)	4 (1.2)	25 Pcs.
HSTTK09-48-Q	3/32	.093 (2.4)	.046 (1.2)	.010 (0.3)	4 (1.2)	25 Pcs.
HSTTK12-48-Q	1/8	.125 (3.2)	.062 (1.6)	.010 (0.3)	4 (1.2)	25 Pcs.
HSTTK19-48-Q	3/16	.187 (4.8)	.093 (2.4)	.010 (0.3)	4 (1.2)	25 Pcs.
HSTTK25-48-Q	1/4	.250 (6.4)	.125 (3.2)	.010 (0.3)	4 (1.2)	25 Pcs.
HSTTK38-48-Q	3/8	.375 (9.5)	.187 (4.8)	.012 (0.3)	4 (1.2)	25 Pcs.
HSTTK50-48-5	1/2	.500 (12.7)	.250 (6.4)	.012 (0.3)	4 (1.2)	5 Pcs.
HSTTK75-48-5	3/4	.750 (19.0)	.375 (9.5)	.017 (0.4)	4 (1.2)	5 Pcs.
HSTTK100-48-5	1	1.00 (25.4)	.500 (12.7)	.019 (0.5)	4 (1.2)	5 Pcs.

## HSTTVA Heat Shrink

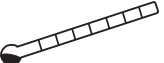
- For damp locations
- Flexible tubing with an adhesive inner wall which seals and protects components from moisture and corrosion



Type	Materials	
HSTTVA	 <b>Polyolefin Cross-Linked with Adhesive</b>	
 600V	 -67°F to 230°F (-55°C to 110°C)	 AMS-DTL-23053/4 Class 2
 Flexible	 Shrink Ratio:▲ 2:1	 Outer Wall Flame Retardant

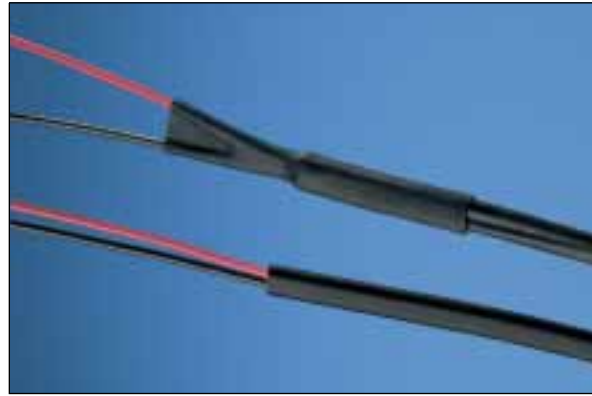

### HSTTVA in Standard Packages — 4' (1.2m) Pieces — Black Only

Part Number	Nominal Diameter in.	Minimum Expanded I.D. in. (mm)	Maximum Recovered I.D. in. (mm)	Nominal Recovered Wall Thickness in. (mm)	Length Feet (m)	Std. Pkg. Qty.*
<b>HSTTVA12-48-Q</b>	1/8	.125 (3.2)	.062 (1.6)	.020 (0.5)	4 (1.2)	25 Pcs.
<b>HSTTVA19-48-Q</b>	3/16	.187 (4.8)	.093 (2.4)	.022 (0.6)	4 (1.2)	25 Pcs.
<b>HSTTVA25-48-Q</b>	1/4	.250 (6.4)	.125 (3.2)	.030 (0.8)	4 (1.2)	25 Pcs.
<b>HSTTVA38-48-Q</b>	3/8	.375 (9.5)	.187 (4.8)	.031 (0.8)	4 (1.2)	25 Pcs.
<b>HSTTVA50-48-5</b>	1/2	.500 (12.7)	.250 (6.4)	.032 (0.8)	4 (1.2)	5 Pcs.
<b>HSTTVA75-48-5</b>	3/4	.750 (19.0)	.375 (9.5)	.037 (0.9)	4 (1.2)	5 Pcs.
<b>HSTTVA100-48-5</b>	1	1.00 (25.4)	.500 (12.7)	.046 (1.2)	4 (1.2)	5 Pcs.
<b>HSTTVA150-48-5</b>	1 1/2	1.50 (38.1)	.750 (19.0)	.049 (1.2)	4 (1.2)	5 Pcs.

## Standard Packs of HSTTVA Heat Shrink — 6" (152.4mm) Pieces

### HSTTVA — Black Only — Single Diameter

Part Number	Nominal Diameter in.	Minimum Expanded I.D. in. (mm)	Maximum Recovered I.D. in. (mm)	Std. Pkg. Qty.*	Std. Ctn. Qty.
<b>HSTTVA12-Y</b>	1/8	.125 (3.2)	.062 (1.6)	7 pcs.	10 Pkgs.
<b>HSTTVA19-Y</b>	3/16	.187 (4.8)	.093 (2.4)	7 pcs.	10 Pkgs.
<b>HSTTVA25-Y</b>	1/4	.250 (6.4)	.125 (3.2)	5 pcs.	10 Pkgs.
<b>HSTTVA38-Y</b>	3/8	.375 (9.5)	.187 (4.8)	4 pcs.	10 Pkgs.
<b>HSTTVA50-Y</b>	1/2	.500 (12.7)	.250 (6.4)	4 pcs.	10 Pkgs.
<b>HSTTVA75-Y</b>	3/4	.750 (19.0)	.375 (9.5)	3 pcs.	10 Pkgs.
<b>HSTTVA100-Y</b>	1	1.00 (25.4)	.500 (12.7)	2 pcs.	10 Pkgs.



\*Order in multiples of std. pkg. qty.







▲ Shrink ratios are approximations; please refer to above ordering information for the exact min. expanded and max. recovered I.D.'s.

# PANDUIT® Dual Wall Polyolefin *DAMP-SHRINK™* Heat Shrink Tubing

## HSTTA Heat Shrink

- For damp locations
- Flexible tubing with adhesive inner wall, seals and protects components from moisture and corrosion
- The 3:1 shrink ratio is a benefit when working with connector to cable transitions

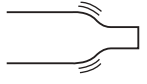

Type	Materials	
HSTTA	 <b>Polyolefin Cross-Linked with Adhesive</b>	
 600V	 -67°F to 230°F (-55°C to 110°C)	 AMS-DTL-23053/4 Class 3
 Flexible	 Shrink Ratio: ▲ 3:1	 Outer Wall Flame Retardant



### HSTTA in Standard and Bulk Packages — 4' (1.2m) Pieces — Black Only

Part Number	Nominal Diameter in.	Minimum Expanded I.D. in. (mm)	Maximum Recovered I.D. in. (mm)	Nominal Recovered Wall Thickness in. (mm)	Length Feet (m)	Std. Pkg. Qty.*
<b>HSTTA19-48-Q</b>	3/16	.187 (4.8)	.062 (1.6)	.040 (1.0)	4 (1.2)	25 Pcs.
<b>HSTTA25-48-Q</b>	1/4	.250 (6.4)	.080 (2.0)	.040 (1.0)	4 (1.2)	25 Pcs.
HSTTA25-48-TL	1/4	.250 (6.4)	.080 (2.0)	.040 (1.0)	4 (1.2)	250 Pcs.
<b>HSTTA38-48-Q</b>	3/8	.375 (9.5)	.120 (3.0)	.055 (1.4)	4 (1.2)	25 Pcs.
HSTTA38-48-TL	3/8	.375 (9.5)	.120 (3.0)	.055 (1.4)	4 (1.2)	250 Pcs.
<b>HSTTA50-48-5</b>	1/2	.500 (12.7)	.160 (4.1)	.070 (1.8)	4 (1.2)	5 Pcs.
HSTTA50-48-T	1/2	.500 (12.7)	.160 (4.1)	.070 (1.8)	4 (1.2)	200 Pcs.
<b>HSTTA75-48-5</b>	3/4	.750 (19.0)	.250 (6.4)	.085 (2.2)	4 (1.2)	5 Pcs.
HSTTA75-48-C	3/4	.750 (19.0)	.250 (6.4)	.085 (2.2)	4 (1.2)	100 Pcs.
<b>HSTTA100-48-5</b>	1	1.00 (25.4)	.320 (8.1)	.100 (2.5)	4 (1.2)	5 Pcs.
HSTTA100-48-L	1	1.00 (25.4)	.320 (8.1)	.100 (2.5)	4 (1.2)	50 Pcs.
<b>HSTTA150-48-5</b>	1 1/2	1.50 (38.1)	.510 (12.9)	.100 (2.5)	4 (1.2)	5 Pcs.
HSTTA150-48-Q	1 1/2	1.50 (38.1)	.510 (12.9)	.100 (2.5)	4 (1.2)	25 Pcs.

### Standard Packs of HSTTA Heat Shrink — 6" (152.4mm) Pieces

#### HSTTA — Black Only — Single Diameter

Part Number	Nominal Diameter in.	Minimum Expanded I.D. in. (mm)	Maximum Recovered I.D. in. (mm)	Std. Pkg. Qty.*	Std. Ctn. Qty.
<b>HSTTA19-Y</b>	3/16	.187 (4.8)	.062 (1.6)	6 pcs.	10 Pkgs.
<b>HSTTA25-Y</b>	1/4	.250 (6.4)	.080 (2.0)	4 pcs.	10 Pkgs.
<b>HSTTA38-Y</b>	3/8	.375 (9.5)	.120 (3.0)	3 pcs.	10 Pkgs.
<b>HSTTA50-Y</b>	1/2	.500 (12.7)	.160 (4.1)	3 pcs.	10 Pkgs.
<b>HSTTA75-Y</b>	3/4	.750 (19.0)	.250 (6.4)	2 pcs.	10 Pkgs.
<b>HSTTA100-Y</b>	1	1.00 (25.4)	.320 (8.1)	2 pcs.	10 Pkgs.
<b>HSTTA150-Y</b>	1 1/2	1.50 (38.1)	.510 (12.9)	1 pcs.	10 Pkgs.







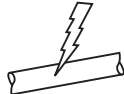

## HSTTRA Heat Shrink

- For damp locations
- Semi-rigid tubing
- Adhesive inner wall which seals and protects components from moisture and corrosion
- Provides a rugged seal from the elements

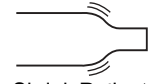

Type	Materials	
<b>HSTTRA</b>	 <b>Polyolefin Cross-Linked with Adhesive</b>	
 600V	 -67°F to 230°F (-55°C to 110°C)	 AMS-DTL-23053/4 Class 1
 Semi-Rigid	 Shrink Ratio: ▲ 2.5:1	



### HSTTRA in Standard Packages — 4' (1.2m) Pieces — Black Only

Part Number	Nominal Diameter in.	Minimum Expanded I.D. in. (mm)	Maximum Recovered I.D. in. (mm)	Nominal Recovered Wall Thickness in. (mm)	Length Feet (m)	Std. Pkg. Qty.*
<b>HSTTRA12-48-Q</b>	1/8	.125 (3.2)	.023 (0.6)	.038 (1.0)	4 (1.2)	25 Pcs.
<b>HSTTRA19-48-Q</b>	3/16	.187 (4.8)	.060 (1.5)	.043 (1.1)	4 (1.2)	25 Pcs.
<b>HSTTRA25-48-Q</b>	1/4	.250 (6.4)	.080 (2.0)	.047 (1.2)	4 (1.2)	25 Pcs.
<b>HSTTRA38-48-Q</b>	3/8	.375 (9.5)	.135 (3.4)	.050 (1.3)	4 (1.2)	25 Pcs.
<b>HSTTRA50-48-5</b>	1/2	.500 (12.7)	.195 (5.0)	.059 (1.5)	4 (1.2)	5 Pcs.
<b>HSTTRA75-48-5</b>	3/4	.750 (19.0)	.313 (8.0)	.065 (1.7)	4 (1.2)	5 Pcs.
<b>HSTTRA100-48-5</b>	1	1.00 (25.4)	.400 (10.6)	.075 (1.9)	4 (1.2)	5 Pcs.

\*Order in multiples of std. pkg. qty.

▲Shrink ratios are approximations; please refer to above ordering information for the exact min. expanded and max. recovered I.D.'s.

# PANDUIT® Thick Wall Polyolefin **WET-SHRINK™** Heat Shrink Tubing

## HST Thick Wall Heat Shrink

- Suitable for wet locations and direct burial according to UL 486D
- Provides excellent protection above or below ground level
- Adhesive lined inner wall seals and protects against moisture



Type	Material		
HST	Polyolefin Cross-Linked with Adhesive		
 600V	 -85°F to 230°F (-65°C to 110°C)	 AMS-DTL-23053/15 (HST only)	
 Rigid	 Shrink Ratio:▲ 3:1	 Flame Retardant	

(Black Only)  
Including HST3.0

Listed 6R72  
(except HST3.0)



## Thick Wall Heat Shrink Part Number System

**HST 0.4 - 3 - Q 2**

Type	Expanded Diameter	Tube Length	Package Quantity	Color
HST	0.4 = .40" (10.2mm) 0.8 = .80" (20.3mm) 1.1 = 1.10" (27.9mm) 1.5 = 1.50" (38.1mm) 2.0 = 2.00" (50.8mm) 3.0 = 3.00" (76.2mm)	3 = 3" (76.2mm) 6 = 6" (152.4mm) 9 = 9" (228.6mm) 12 = 12" (304.8mm) 48 = 4' (1.2m)	1 = 1 Pcs. 2 = 2 Pcs. 3 = 3 Pcs. 5 = 5 Pcs. X = 10 Pcs. Q = 25 Pcs.	None = Black 2 = Red



## HST in Standard Packages

Part Number (Black)	Minimum Expanded I.D. in. (mm)	Maximum Recovered I.D. in. (mm)	Nominal Recovered Wall Thickness in. (mm)	Conductor Size Range AWG/kcmil (mm²)	Minimum Cable O.D. in. (mm)	Maximum Connector O.D. in. (mm)	Tube Length in. (mm)	Std. Pkg. Qty.*	Std. Ctn. Qty.
<b>HST0.4-3-Q‡</b> <b>HST0.4-6-3</b> <b>HST0.4-6-X‡</b> <b>HST0.4-48-5‡</b>	.40 (10.1)	.15 (3.8)	.09 (2.3)	#12-#6 (4-16)	.170 (4.3)	.350 (8.9)	3 (76.2) 6 (152.4) 6 (152.4) 4' (1.2M)	25 Pcs. 3 Pcs. 10 Pcs. 5 Pcs.	4 Pkgs. 10 Pkgs. 10 Pkgs. 4 Pkgs.
<b>HST0.8-6-3</b> <b>HST0.8-6-X‡</b> <b>HST0.8-9-X‡</b> <b>HST0.8-12-5‡</b> <b>HST0.8-48-5‡</b>	.80 (20.3)	.25 (6.4)	.11 (2.8)	#8-#1/0 (10-55)	.240 (6.1)	.650 (16.5)	6 (152.4) 6 (152.4) 9 (228.6) 12 (304.8) 4' (1.2M)	3 Pcs. 10 Pcs. 10 Pcs. 5 Pcs. 5 Pcs.	10 Pkgs. 10 Pkgs. 10 Pkgs. 10 Pkgs. 4 Pkgs.
<b>HST1.1-6-3</b> <b>HST1.1-6-X‡</b> <b>HST1.1-9-2</b> <b>HST1.1-9-X‡</b> <b>HST1.1-12-5‡</b> <b>HST1.1-48-5‡</b>	1.10 (27.9)	.37 (9.4)	.12 (3.0)	#2-#4/0 (35-120)	.400 (10.1)	.875 (22.2)	6 (152.4) 6 (152.4) 9 (228.6) 9 (228.6) 12 (304.8) 4' (1.2M)	3 Pcs. 10 Pcs. 2 Pcs. 10 Pcs. 5 Pcs. 5 Pcs.	10 Pkgs. 10 Pkgs. 10 Pkgs. 10 Pkgs. 10 Pkgs. 4 Pkgs.
<b>HST1.5-9-X</b> <b>HST1.5-12-1</b> <b>HST1.5-12-5</b> <b>HST1.5-48-5</b>	1.50 (38.1)	.50 (12.7)	.17 (4.3)	#3/0-400 kcmil (95-185)	.600 (15.2)	1.190 (30.2)	9 (228.6) 12 (304.8) 12 (304.8) 4' (1.2M)	10 Pcs. 1 Pcs. 5 Pcs. 5 Pcs.	10 Pkgs. 10 Pkgs. 10 Pkgs. 4 Pkgs.
<b>HST2.0-9-5</b> <b>HST2.0-12-2</b> <b>HST2.0-48-2</b>	2.00 (50.8)	.67 (16.9)	.17 (4.3)	250-600 kcmil (125-300)	.750 (19.1)	1.600 (40.6)	9 (228.6) 12 (304.8) 4' (1.2M)	5 Pcs. 2 Pcs. 2 Pcs.	10 Pkgs. 10 Pkgs. 4 Pkgs.
<b>HST3.0-12-2</b> <b>HST3.0-48-2</b>	3.00(76.2)	1.00 (25.4)	.17 (4.3)	600-1250 kcmil (300-625)	1.20 (30.5)	2.250 (57.2)	12 (304.8) 4' (1.2M)	2 Pcs. 2 Pcs.	10 Pkgs. 4 Pkgs.

## HSEC Thick Wall End Caps

- For wet locations
- Provides excellent protection for sealing ends of wire or cable
- Adhesive lined inner wall seals and protects against moisture

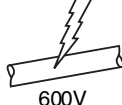
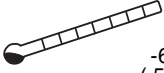

Type	Materials
<b>HSEC</b>	 Polyolefin Cross-Linked with Adhesive
 600V	 -67°F to 221°F (-55°C to 105°C)
 Rigid	 Shrink Ratio: ▲ 3:1



### Thick Wall End Caps Part Number System

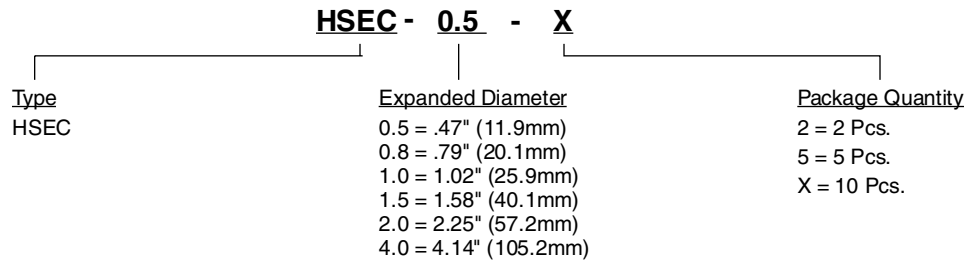

### Thick Wall End Caps in Standard Packages — Black Only

Part Number	Minimum Expanded I.D. in. (mm)	Maximum Recovered I.D. in. (mm)	Nominal Recovered Wall Thickness in. (mm)	Conductor Size	Cap Length in. (mm)	Std. Pkg. Qty.*	Std. Ctn. Qty.
<b>HSEC0.5-X</b>	.47 (11.9)	.18 (4.6)	.10 (2.5)	#8 to #4 AWG (10 to 25mm <sup>2</sup> )	1.38 (35.1)	10 Pcs.	10 Pkgs.
<b>HSEC0.8-X</b>	.79 (20.1)	.30 (7.6)	.10 (2.5)	#4 to 3/0 AWG (25 to 95mm <sup>2</sup> )	2.13 (54.1)	10 Pcs.	10 Pkgs.
<b>HSEC1.0-X</b>	1.02 (25.9)	.45 (11.4)	.10 (2.5)	#2 to 4/0 AWG (35 to 95mm <sup>2</sup> )	3.23 (82.0)	10 Pcs.	10 Pkgs.
<b>HSEC1.5-5</b>	1.58 (40.1)	.68 (17.3)	.11 (2.8)	250 TO 500 kcmil (120 TO 240mm <sup>2</sup> )	3.86 (98.0)	5 Pcs.	10 Pkgs.
<b>HSEC2.0-5</b>	2.25 (57.2)	.87 (22.1)	.15 (3.8)	600 TO 1000 kcmil (300 TO 500mm <sup>2</sup> )	5.52 (140.2)	5 Pcs.	10 Pkgs.
<b>HSEC4.0-2</b>	4.14 (105.2)	1.78 (45.2)	.15 (3.8)	1500 TO 2000 kcmil (720 TO 1000mm <sup>2</sup> )	6.90 (175.3)	2 Pcs.	5 Pkgs.

\*Order in multiples of std. pkg. qty.



▲ Shrink ratios are approximations; please refer to above ordering information for the exact min. expanded and max. recovered I.D.'s.

## Plastic Kit Boxes

- Provides organized storage for a wide variety of parts in one convenient location
- Informative label eliminates guess work:
  - Specifies correct heat shrink usage based on wire range and connector size
  - Provides reorder part number information
- Once top is closed, loose pieces remain in their 6 compartments
- Available with non-adhesive or adhesive lined heat shrink tubing for dry and damp locations





**DRY**  
**SHRINK™**  
HEAT SHRINK

KP-HSTT1 Contents	For Dry Locations	
BLACK POLYOLEFIN <i>DRY-SHRINK™</i> HEAT SHRINK TUBING (TYPE HSTT) IN 6" (152.4mm) LENGTHS 2:1 SHRINK RATIO		
		 AMS-DTL-23053/5 CLASS 1
35 EACH HSTT09 3/32" (2.4mm) I.D. HSTT12 1/8" (3.2mm) I.D.	21 EACH HSTT19 3/16" (4.8mm) I.D. HSTT25 1/4" (6.4mm) I.D.	7 EACH HSTT38 3/8" (9.5mm) I.D. HSTT50 1/2" (12.7mm) I.D.



**DRY**  
**SHRINK™**  
HEAT SHRINK

KP-HSTT2 Contents	For Dry Locations	
MULTIPLE COLOR POLYOLEFIN <i>DRY-SHRINK™</i> HEAT SHRINK TUBING (TYPE HSTT) IN 6" (152.4mm) LENGTHS 2:1 SHRINK RATIO		
	 (Except Clear)	 (Except Clear) AMS-DTL-23053/5 CLASS 1 & 2
35 EACH HSTT09 3/32" (2.4mm) I.D. - 7 COLORS HSTT12 1/8" (3.2mm) I.D. - 7 COLORS	21 EACH HSTT19 3/16" (4.8mm) I.D. - 7 COLORS HSTT25 1/4" (6.4mm) I.D. - 7 COLORS	7 EACH HSTT38 3/8" (9.5mm) I.D. - 7 COLORS HSTT50 1/2" (12.7mm) I.D. - 7 COLORS

Note: Colors include: Red, Yellow, Green, Blue, White, Clear and Black.



**DAMP**  
**SHRINK™**  
HEAT SHRINK

KP-HSTTA Contents	For Damp Locations	
ADHESIVE LINED BLACK POLYOLEFIN <i>DAMP-SHRINK™</i> HEAT SHRINK TUBING (TYPE HSTTA) IN 6" (152.4mm) LENGTHS 3:1 SHRINK RATIO		
	AMS-DTL-23053/4 CLASS 3	
14 EACH HSTTA19 3/16" (4.8mm) I.D.	10 EACH HSTTA38 3/8" (9.5mm) I.D.	3 EACH HSTTA75 3/4" (19.0mm) I.D.
12 EACH HSTTA25 1/4" (6.4mm) I.D.	6 EACH HSTTA50 1/2" (12.7mm) I.D.	2 EACH HSTTA100 1" (25.4mm) I.D.

Order number of kits required.



Mica insulation in the heat element provides extended life to HSG Heat Tools.



HSG Heat tool with stand



Heat Reflector Accessory slips onto heat tools



Heat Concentrator Accessory directs heat to reduce shrink time



DCT — Cutting Tool



Carrying Case

**Heat Tools**

Part Number	 Listed 826N (Heat Tools only)  (Heat Tools only)	Std. Pkg. Qty
Description		
<b>HSG-115V-650</b>	<ul style="list-style-type: none"> <li>High temperature tool — For use on <i>PANDUIT®</i> HSTT, HSTTA, HSTTF, HSTTR, HSTTK, HSTTRA, HST and HSEC</li> <li>Air intake regulator varies temperature from 650°F (344°C) to 900°F (482°C) 115 Volt, 10 AMP</li> <li>Neoprene jacketed cord with molded strain relief</li> <li>Adjustable stand included</li> <li>Replaceable bearings, brushes and heating elements</li> </ul>	1

**Accessories**

Part Number	Description	Std. Pkg. Qty
<b>HSG-A1</b>	<ul style="list-style-type: none"> <li>Shrink tube reflector for tubing up to 3/4" inside diameter</li> <li>Directs heat around the tubing to reduce shrink time</li> </ul>	1
<b>HSG-A2</b>	<ul style="list-style-type: none"> <li>Shrink tube reflector for tubing up to 1 1/2" inside diameter</li> <li>Directs heat around the tubing to reduce shrink time</li> </ul>	1
<b>HSG-A3</b>	<ul style="list-style-type: none"> <li>Shrink tube concentrator</li> <li>Directs heat toward tubing and away from heat sensitive items</li> </ul>	1
<b>HSG-A4</b>	<ul style="list-style-type: none"> <li>Black polyethylene carrying case</li> <li>Stores heat tool, stand and all three accessories</li> </ul>	1
<b>DCT</b>	<ul style="list-style-type: none"> <li>Cutting tool for use with HST Thick Wall Heat Shrink Tubing only</li> </ul>	1

**Replacement Parts**

Part Number	Description	Std. Pkg. Qty
<b>HSG-P1</b>	• Brush/Spring Kit	1
<b>HSG-P2</b>	• Switch 20 Amp	1
<b>HSG-P3</b>	• Bearing Kit	1
<b>HSG-P7</b>	• Heat Element 650°F	1

Order number of heat tools, accessories and replacement parts required.

## Heat Shrink Installation Instructions

### General Instructions

Position heat shrink over the object to be covered. Using a heat gun, soft yellow flame torch, infrared heat source or oven, evenly heat the tubing until it has fully recovered and conforms to the object. Use caution not to char or burn the tubing.

### Special Instructions for HSTTT

TFE tubing is the most difficult to shrink due to its high shrink temperature. TFE shrink tubing must be heated to the gel state 621°F (327°C) to completely recover. This can be recognized when the tubing changes from milky white to clear color. It can be shrunk with a heat gun or torch, however, it is very difficult to use these methods since they have a tendency to overheat the tube in one area while other areas remain too cool. The most reliable way to shrink TFE is in an oven. Position the heat shrink over the object to be covered and place it in an oven set at 800°F (427°C) until the tubing turns clear. Once clear, remove assembly from oven to prevent over heating and allow it to cool at room temperature. Do not quench in cold air or water. Large objects, particularly metal tubing or rods, must be preheated to get a uniform shrink.

---

## Size Selection for Heat Shrink Tubing

Generally, the largest tube that shrinks down tightly onto an object should be chosen. This allows the heat shrink tubing maximum stress relief and this will yield the longest service life.

Example:

A multi-conductor cable needs to be covered with HSTT Type *DRY-SHRINK™* Heat Shrink. The area to be covered has a measured outside diameter of .700" (17.8mm). The two possibilities are HSTT75-48-5 and HSTT100-48-5.

Part Number	Expanded I.D. in. (mm)	Recovered I.D. in. (mm)
HSTT75-48-5	.750 (19.0)	.375 (9.5)
HSTT100-48-5	1.00 (25.4)	.500 (12.7)

The proper choice is HSTT100-48-5 since the tube will recover more than HSTT75-48-5. The HSTT75-48-5 will fit over the .700" (17.8mm) outside diameter; however, this is not the proper choice since it is smaller than the HSTT100-48-5. In general, heat shrink should recover at least 10-20% to reduce stress and yield

## Recommended Tubing Size for Common Wire Types Based on Location

### For Insulated Wire, Non-insulated Wire and Insulated Wire With Copper Connectors

#### Instructions for tube selection:

1) Determine Location Type.

#### LOCATION:

**DRY — IP62:** A location not normally subject to dampness or wetness. A location classified as dry may be temporarily subject to dampness or wetness, as in the case of a building under construction.

**DAMP — IP66:** Partially protected locations under canopies, marquees, roofed open porches, and like locations, and interior locations subject to moderate degrees of moisture, such as some basements, some barns and some cold-storage warehouses.

**WET — IP68:** Installations underground or in concrete slabs or masonry in direct contact with the earth, and locations subject to saturation with water or other liquids, such as vehicle washing areas, and locations exposed to weather and unprotected.

2) Match wire size to location type under required application — insulated wire, non-insulated wire, or insulated wire with copper connectors.

3) Read corresponding part number.

4) Part numbers with “-Y” are packages containing 6” pieces. Part numbers with “-48” are 48” pieces.

5) Part numbers shown below are for black heat shrink. Consult relevant catalog section for color options.

Wire Size	Insulated Wire			Uninsulated Wire			Insulated Wire with Copper Connector		
	DRY-SHRINK™	DAMP-SHRINK™	WET-SHRINK™	DRY-SHRINK™	DAMP-SHRINK™	WET-SHRINK™	DRY-SHRINK™	DAMP-SHRINK™	WET-SHRINK™
24	HSTT12-Y	HSTTA19-Y	—	—	—	—	HSTT12-Y	—	—
22	HSTT12-Y	HSTTA19-Y	—	—	—	—	HSTT12-Y	—	—
20	HSTT12-Y	HSTTA19-Y	—	HSTT06-Y	—	—	HSTT19-Y	HSTTA19-Y	—
18	HSTT19-Y	HSTTA19-Y	—	HSTT06-Y	—	—	HSTT19-Y	HSTTA19-Y	—
16	HSTT19-Y	HSTTA25-Y	—	HSTT06-Y	—	—	HSTT19-Y	HSTTA25-Y	—
14	HSTT19-Y	HSTTA25-Y	—	HSTT12-Y	HSTTA19-Y	—	HSTT19-Y	HSTTA25-Y	—
12	HSTT25-Y	HSTTA38-Y	HST0.4-48-5	HSTT12-Y	HSTTA19-Y	—	HSTT25-Y	HSTTA38-Y	HST0.4-48-5
10	HSTT25-Y	HSTTA38-Y	HST0.4-48-5	HSTT19-Y	HSTTA25-Y	—	HSTT25-Y	HSTTA38-Y	HST0.4-48-5
8	HSTT38-Y	HSTTA50-Y	HST0.4-48-5	HSTT25-Y	HSTTA25-Y	—	HSTT38-Y	HSTTA50-Y	HST0.4-48-5
6	HSTT50-Y	HSTTA50-Y	HST0.8-48-5	HSTT25-Y	HSTTA38-Y	HST0.4-48-5	HSTT50-Y	HSTTA50-Y	HST0.8-48-5
4	HSTT50-Y	HSTTA75-Y	HST0.8-48-5	HSTT38-Y	HSTTA38-Y	HST0.4-48-5	HSTT50-Y	HSTTA75-Y	HST0.8-48-5
3	HSTT50-Y	HSTTA75-Y	HST0.8-48-5	HSTT38-Y	HSTTA50-Y	HST0.4-48-5	HSTT50-Y	HSTTA75-Y	HST0.8-48-5
2	HSTT75-Y	HSTTA100-Y	HST0.8-48-5	HSTT50-Y	HSTTA50-Y	HST0.8-48-5	HSTT75-Y	HSTTA100-Y	HST0.8-48-5
1	HSTT75-Y	HSTTA100-Y	HST0.8-48-5	HSTT50-Y	HSTTA50-Y	HST0.8-48-5	HSTT75-Y	HSTTA100-Y	HST1.1-48-5
1/0	HSTT75-Y	HSTTA100-Y	HST1.1-48-5	HSTT50-Y	HSTTA75-Y	HST0.8-48-5	HSTT75-Y	HSTTA100-Y	HST1.1-48-5
2/0	HSTT100-Y	HSTTA100-Y	HST1.1-48-5	HSTT50-Y	HSTTA75-Y	HST0.8-48-5	HSTT100-Y	HSTTA100-Y	HST1.1-48-5
3/0	HSTT100-Y	HSTTA150-Y	HST1.1-48-5	HSTT75-Y	HSTTA100-Y	HST0.8-48-5	HSTT100-Y	HSTTA150-Y	HST1.5-48-5
4/0	HSTT100-Y	HSTTA150-Y	HST1.5-48-5	HSTT75-Y	HSTTA100-Y	HST1.1-48-5	HSTT100-Y	HSTTA150-Y	HST1.5-48-5
250	HSTT100-Y	HSTTA150-Y	HST1.5-48-5	HSTT100-Y	HSTTA100-Y	HST1.1-48-5	HSTT100-Y	HSTTA150-Y	HST1.5-48-5
300	HSTT150-48-5	HSTTA150-Y	HST1.5-48-5	HSTT100-Y	HSTTA100-Y	HST1.1-48-5	HSTT150-Y	HSTTA150-Y	HST1.5-48-5
350	HSTT150-48-5	HSTTA150-Y	HST1.5-48-5	HSTT100-Y	HSTTA150-Y	HST1.5-48-5	HSTT150-48-5	HSTTA150-Y	HST2.0-48-2
400	HSTT150-48-5	HSTTA150-Y	HST2.0-48-2	HSTT100-Y	HSTTA150-Y	HST1.5-48-5	HSTT150-48-5	HSTTA150-Y	HST2.0-48-2
500	HSTT150-48-5	HSTTA150-Y	HST2.0-48-2	HSTT100-Y	HSTTA150-Y	HST1.5-48-5	HSTT150-48-5	HSTTA150-Y	HST2.0-48-2
600	HSTT150-48-5	HSTTA150-Y	HST2.0-48-2	HSTT150-48-5	HSTTA150-Y	HST2.0-48-2	HSTT150-48-5	HSTTA150-Y	HST2.0-48-2
700	HSTT200-48-5	HSTTA150-Y	HST2.0-48-2	HSTT150-48-5	HSTTA150-Y	HST2.0-48-2	HSTT200-48-5	—	HST2.0-48-2
750	HSTT200-48-5	HSTTA150-Y	HST3.0-48-2	HSTT150-48-5	HSTTA150-Y	HST2.0-48-2	HSTT200-48-5	—	HST3.0-48-2
800	HSTT200-48-5	—	HST3.0-48-2	HSTT150-48-5	HSTTA150-Y	HST2.0-48-2	HSTT200-48-5	—	HST3.0-48-2
900	HSTT200-48-5	—	HST3.0-48-2	HSTT150-48-5	HSTTA150-Y	HST2.0-48-2	HSTT200-48-5	—	HST3.0-48-2
1000	HSTT200-48-5	—	HST3.0-48-2	HSTT200-48-5	HSTTA150-Y	HST2.0-48-2	HSTT200-48-5	—	HST3.0-48-2
1250	HSTT300-48-2	—	HST3.0-48-2	HSTT200-48-5	HSTTA150-Y	HST2.0-48-2	—	—	HST3.0-48-2
1500	HSTT300-48-2	—	HST3.0-48-2	HSTT200-48-5	—	HST3.0-48-2	—	—	—
1750	HSTT300-48-2	—	HST3.0-48-2	HSTT200-48-5	—	HST3.0-48-2	—	—	—
2000	HSTT300-48-2	—	HST3.0-48-2	HSTT200-48-5	—	HST3.0-48-2	—	—	—

Sizing information is based on the following wire types: MTW, THHN, THWN, TFN, THW, TW, TF, RHW, RH, RHH AND UL1015.

THHN is the most common wire type.

Portions reprinted with permission from NFPA, the National Electrical Code® Handbook, Copyright© 1996, National Fire Protection Association, Quincy, MA 02269.

All rights reserved. National Electrical Code® and NEC® are registered trademarks of the National Fire Protection Association, Inc., Quincy, MA 02269.

# PANDUIT® IP (Ingress Protection) as defined by the International Standard IEC 529

The IEC 529 international standard describes a system for classifying the degrees of protection provided by the enclosures of electrical equipment and is a recognized standard around the world. An independent test laboratory has tested *PANDUIT®* Heat Shrink Tubing to the IEC 529 standard. The following information exhibits the IP ratings for *PANDUIT®* Heat Shrink tubing and how each of the IP ratings relates to the USA.

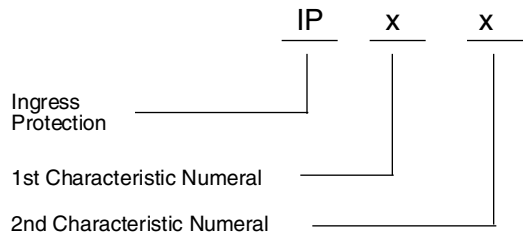

The first characteristic numeral indicates the level of protection against the ingress of solid foreign objects.

The second characteristic numeral indicates the level of protection against the ingress of water.

1st Characteristic Numeral			2nd Characteristic Numeral		
<i>PANDUIT®</i> Heat Shrink	Ingress Protection (IP)	Meaning for Protection	<i>PANDUIT®</i> Heat Shrink	Ingress Protection (IP)	Meaning for Protection
	Against ingress of solid object			Against ingress of water	
	0	Non-Protected		0	Non-Protected
	1	50mm diameter		1	Vertically Dripping
	2	12.5mm diameter	<i>DRY-SHRINK™</i> Heat Shrink Tubing	2	Dripping (15° tilted)
	3	2.5mm diameter		3	Spraying
	4	1.0mm diameter		4	Splashing
	5	Dust Protected		5	Jetting
<i>DRY-SHRINK™</i> , <i>DAMP-SHRINK™</i> and <i>WET-SHRINK™</i>	6	Dust Tight	<i>DAMP-SHRINK™</i> Heat Shrink Tubing	6	Powerful Jetting
				7	Temporary Immersion
			<i>WET-SHRINK™</i> Heat Shrink Tubing	8	Continuous Immersion

	Intended Application Location:	Ingress Protection Rating:	Description:
	<b>DRY</b> Locations not normally subject to moisture		Protected against the ingress of dust but not protected against the ingress of water.
	<b>DAMP</b> Locations subjected to moderate degrees of water and moisture		Protected against the ingress of dust and protected against the ingress of a power jet of water.
	<b>WET</b> Locations are defined as underground burial or immersion in water		Protected against the ingress of dust <i>and</i> protected against the ingress of water to a depth of 10 meters.

Does not include *PANDUIT® DRY-SHRINK™* HSTTT (TEFLON —TFE)

*DRY-SHRINK™* Heat Shrink has been tested in accordance with EN 60529 paragraph 13.4 thereby providing *PANDUIT® DRY-SHRINK™* Heat Shrink with an ingress protection rating of IP62.

*DAMP-SHRINK™* Heat Shrink has been tested in accordance with EN 60529 paragraph 13.4 and with paragraph 14.2.6 thereby providing *PANDUIT® DAMP-SHRINK™* with an ingress protection rating of IP66.

*WET-SHRINK™* Heat Shrink has been tested in accordance with EN 60529 paragraph 13.4, paragraph 14.2.6 and with paragraph 14.2.7 thereby providing *WET-SHRINK™* Heat Shrink with an ingress protection rating of IP68. *PANDUIT® WET-SHRINK™* Heat Shrink has passed EN 60529 paragraph 14.2.7 at depth of 10 meters.



## Technical Data

### General Information

Product Type	Typical Applications	Specific Gravity	Flammability	Water Absorption	Dielectric Strength	Page No.
<b>HSTT</b>	Economical and easy way to insulate, protect, harness and identify electrical and electronic components in a wide variety of applications. Black is U.V. Resistant.	Class 1, 1.35 Class 2, 1.0 ASTM D792	Class 1 Self Extinguishing Class 2 N/A ASTM D2671 Procedure B	0.5% MAX. ASTM D570	500 V/MIL. (19.7 Kv/mm) min. ASTM D2671	<b>141-144</b>
<b>HSTTV</b>	Use where UL recognition with VW-1 rating is required. Use where the wire component cannot tolerate higher shrink temperatures, reduces application time to insulate, protect, identify, etc. Black is U.V. Resistant.	1.50 ASTM D792	Self Extinguishing ASTM D2671 Procedure C	0.5% MAX. ASTM D570	500 V/MIL. (19.7 Kv/mm) min. ASTM D2671	<b>145-146</b>
<b>HSTTVA</b>	Seals and protects components from moisture and corrosion. Use where a flexible tubing is needed. Suitable for damp locations.	N/A	Self Extinguishing ASTM D2671 Procedure B	0.5% MAX. ASTM D570	500 V/MIL. (19.7 Kv/mm) min. ASTM D2671	<b>151</b>
<b>HSTTRA</b>	Environmentally seals and protects components forming a rugged and heavy duty covering. The 2.5:1 shrink ratio is a benefit when working with connector to cable transitions. Suitable for damp locations.	N/A	N/A	0.5% MAX. ASTM D570	500 V/MIL. (19.7 Kv/mm) min. ASTM D2671	<b>153</b>
<b>HSTTA</b>	Environmentally seals and protects components. The 3:1 shrink ratio is a benefit when working with connector to cable transitions. Suitable for damp locations.	N/A	Self Extinguishing ASTM D2671 Procedure B	1.0% MAX. ASTM D570	300 V/MIL. (11.8 Kv/mm) min. ASTM D2671	<b>152</b>
<b>HST</b>	Seals and protects electrical connections and splices above or below ground, 3:1 shrink ratio. Suitable for outdoor and wet locations.	1.2 MAX.	Self Extinguishing ASTM D2671 Procedure C	0.5% MAX. ASTM D570	200 V/MIL. (7.9 Kv/mm) min. ASTM D2671	<b>154</b>
<b>HSTTP</b>	Ripple free conformance around sharp bends as in appliance handles and bus bars. Good cut through and solder-iron resistance. Black is U.V. Resistant.	1.35 MAX.	Self Extinguishing ASTM D876	1.0% MAX. ASTM D570	400 V/MIL. (15.8 Kv/mm) min. ASTM D2671	<b>147</b>
<b>HSTTN</b>	Insulation and abrasion resistance, extensive military uses on vehicles and ship-board. Excellent chemical resistance especially to fuels and oils. Black is U.V. Resistant.	1.30 ASTM D792	Self Extinguishing ASTM D876	1.0% MAX. ASTM D570	300V/MIL. (11.8 Kv/mm) min. ASTM D2671	<b>148</b>
<b>HSTTK</b>	Protection and strain relief for wires or connectors in a high temperature or solvent rich environment. Insulation of heater leads.	1.8 MAX. ASTM D792	Pass MIL-DTL-23053/8B 4.6.15.3	0.5% MAX. ASTM D570	Size to .500" (12.7mm) 800V/MIL. (31.5 Kv/mm) min. Over .500" (12.7mm) 600 V/MIL (23.6 Kv/mm) min. ASTM D2671	<b>150</b>
<b>HSTTT</b>	High insulation and abrasion resistance. High temperature, strain relief, resists corrosive atmospheres, self lubrication and non-wetting. Can be used with fiber optics and as a strain relief for high density connectors. It is U.V. Resistant	2.2 MAX. ASTM D792	N/A Non-flammable	0.01% MAX. ASTM D570	800 V/MIL. (31.5 Kv/mm) min. ASTM D2671	<b>149</b>

## Non-Shrink PVC Tubing

- Provides insulation and protection for lead wires, wire harness assemblies, soldered joints and components in electrical and electronic equipment
- Material: Polyvinyl chloride (PVC)
- Voltage Rating: 300V and 600V
- All purpose, flexible, non-shrinkable
- Resistant to heat and moisture
- Applicable Specifications:
  - UL224 VW-1
  - CSA C22.2 No. 198.1 (OFT)
  - ASTM D-922, Grade CFR
  - MIL-I-631, Type F, Form U, Grade C
  - Class 1, Category 1



## The Functional Part Number System Makes Ordering Easy





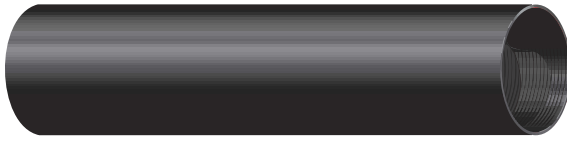

### Non-Shrink PVC Tubing Part Number System

#### TV105 - 19 M

Type	Nominal Size		Package Quantity
Polyvinyl Chloride Tubing	22 = 22 AWG	4 = 4 AWG	L = 50' (15.2m)
	20 = 20 AWG	3 = 3 AWG	C = 100' (30.5m)
	19 = 19 AWG	2 = 2 AWG	TL = 250' (76.2m)
	18 = 18 AWG	1 = 1 AWG	D = 500' (152.4m)
	16 = 16 AWG	0 = 0 AWG	M = 1000' (304.8m)
	15 = 15 AWG	.25 = 1/4"	2.5M = 2500' (762m)
	14 = 14 AWG	.31 = 5/16"	
	12 = 12 AWG	.38 = 3/8"	
	10 = 10 AWG	.44 = 6/16"	
	9 = 9 AWG	.50 = 1/2"	
	8 = 8 AWG	.56 = 9/16"	
	7 = 7 AWG	.63 = 5/8"	
	6 = 6 AWG	.75 = 3/4"	
	5 = 5 AWG	1.0 = 1"	

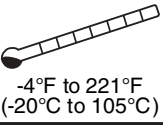
## Non-Shrink PVC Tubing



Type	Materials	
TV105	 Polyvinyl Chloride	
 300V/600V**	 -4°F to 221°F (-20°C to 105°C)	 MIL-I-631, Type F, Form U Grade C Class 1, Cat 1
 Highly Flexible	 Oil Resistant	 Highly Flame Retardant VW-1

Part Number Clear	Part Number Black	Nominal Size/ Trade Name	Inside Diameter — in. (mm)		Wall Thickness in. (mm)	Max. Volt Rating**	Std. Pkg. Qty.*	Std. Ctn. Qty.
			Maximum	Minimum				
<b>TV105-242.5M</b>	<b>TV105-242.5M20</b>	24 AWG	.027 (0.68)	.020 (0.51)	.012 (.30)	300V	2500 (762m)	2 Reels
<b>TV105-222.5M</b>	<b>TV105-222.5M20</b>	22 AWG	.032 (0.81)	.025 (0.69)			2500 (762m)	2 Reels
<b>TV105-20M</b>	<b>TV105-20M20</b>	20 AWG	.039 (0.99)	.032 (0.81)			1000 (304.8m)	2 Reels
<b>TV105-19M</b>	<b>TV105-19M20</b>	19 AWG	.042 (1.06)	.036 (0.91)	.016 (.41)	300V	1000 (304.8m)	2 Reels
<b>TV105-18M</b>	<b>TV105-18M20</b>	18 AWG	.049 (1.24)	.040 (1.02)			1000 (304.8m)	2 Reels
<b>TV105-17M</b>	<b>TV105-17M20</b>	17 AWG	.053 (1.34)	.045 (1.14)			1000 (304.8m)	2 Reels
<b>TV105-16M</b>	<b>TV105-16M20</b>	16 AWG	.061 (1.54)	.051 (1.30)			1000 (304.8m)	2 Reels
<b>TV105-15M</b>	<b>TV105-15M20</b>	15 AWG	.066 (1.67)	.057 (1.45)			1000 (304.8m)	2 Reels
<b>TV105-14M</b>	<b>TV105-14M20</b>	14 AWG	.072 (1.82)	.064 (1.63)			1000 (304.8m)	2 Reels
<b>TV105-13M</b>	<b>TV105-13M20</b>	13 AWG	.080 (2.03)	.072 (1.83)			1000 (304.8m)	2 Reels
<b>TV105-12D</b>	<b>TV105-12D20</b>	12 AWG	.089 (2.26)	.081 (2.06)			500 (152.4m)	2 Reels
<b>TV105-11D</b>	<b>TV105-11D20</b>	11 AWG	.101 (2.56)	.091 (2.31)			500 (152.4m)	2 Reels
<b>TV105-10D</b>	<b>TV105-10D20</b>	10 AWG	.112 (2.84)	.102 (2.59)			500 (152.4m)	2 Reels
<b>TV105-9D</b>	<b>TV105-9D20</b>	9 AWG	.124 (3.14)	.114 (2.90)	.020 (.51)	300V	500 (152.4m)	2 Reels
<b>TV105-8D</b>	<b>TV105-8D20</b>	8 AWG	.141 (3.58)	.129 (3.28)			500 (152.4m)	2 Reels
<b>TV105-7D</b>	<b>TV105-7D20</b>	7 AWG	.158 (4.01)	.144 (3.66)			500 (152.4m)	2 Reels
<b>TV105-6TL</b>	<b>TV105-6TL20</b>	6 AWG	.178 (4.52)	.162 (4.11)			250 (76.2m)	2 Reels
<b>TV105-5TL</b>	<b>TV105-5TL20</b>	5 AWG	.198 (5.02)	.182 (4.62)			250 (76.2m)	2 Reels
<b>TV105-4TL</b>	<b>TV105-4TL20</b>	4 AWG	.224 (5.68)	.204 (5.18)			250 (76.2m)	2 Reels
<b>TV105-3TL</b>	<b>TV105-3TL20</b>	3 AWG	.249 (6.32)	.229 (5.82)			250 (76.2m)	2 Reels
<b>TV105-2TL</b>	<b>TV105-2TL20</b>	2 AWG	.278 (7.06)	.258 (6.55)			250 (76.2m)	2 Reels
<b>TV105-1TL</b>	<b>TV105-1TL20</b>	1 AWG	.311 (7.89)	.289 (7.34)			250 (76.2m)	2 Reels
<b>TV105-0TL</b>	<b>TV105-0TL20</b>	0 AWG	.347 (8.81)	.325 (8.26)			250 (76.2m)	2 Reels
<b>TV105-.25TL</b>	<b>TV105-.25TL20</b>	1/4	.265 (6.73)	.245 (6.22)	.025 (.64)	300V	250 (76.2m)	2 Reels
<b>TV105-.31TL</b>	<b>TV105-.31TL20</b>	5/16	.334 (8.48)	.313 (7.95)			250 (76.2m)	2 Reels
<b>TV105-.38TL</b>	<b>TV105-.38TL20</b>	3/8	.399 (10.13)	.375 (9.53)			250 (76.2m)	2 Reels
<b>TV105-.44TL</b>	<b>TV105-.44TL20</b>	7/16	.462 (11.73)	.438 (11.13)			250 (76.2m)	2 Reels
<b>TV105-.50TL</b>	<b>TV105-.50TL20</b>	1/2	.524 (13.30)	.500 (12.70)	.030 (.76)	600V	250 (76.2m)	2 Reels
<b>TV105-.56C</b>	<b>TV105-.56C20</b>	9/16	.585 (14.85)	.563 (14.30)			100 (30.5m)	2 Reels
<b>TV105-.63C</b>	<b>TV105-.63C20</b>	5/8	.655 (16.63)	.625 (15.88)			100 (30.5m)	2 Reels
<b>TV105-.75C</b>	<b>TV105-.75C20</b>	3/4	.786 (19.96)	.750 (19.05)			100 (30.5m)	2 Reels
<b>TV105-.88C</b>	<b>TV105-.88C20</b>	7/8	.911 (23.13)	.875 (22.23)	.035 (.89)	600V	100 (30.5m)	2 Reels
<b>TV105-1.0L</b>	<b>TV105-1.0L20</b>	1	1.036 (26.31)	1.000 (25.40)			50 (15.2m)	2 Reels
<b>TV105-1.25L</b>	<b>TV105-1.25L20</b>	1 1/4	1.290 (32.76)	1.250 (31.75)			50 (15.2m)	2 Reels
<b>TV105-1.50L</b>	<b>TV105-1.50L20</b>	1 1/2	1.550 (39.37)	1.500 (38.10)	.045 (1.14)	600V	50 (15.2m)	2 Reels

\*Order in multiples of std. pkg. qty.

\*\*UL voltage rating is a function of wall thickness.

## Spiral Wrap

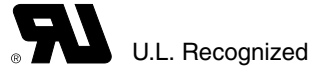

- Large variety of colors, materials and sizes
- Available in seven different materials and twelve different colors
- Can be used to color code wire bundles
- Flexible, neat, fast
- Allows breakouts of single/multiple wires and rerouting of replacement wires
- Harness multiple cables into a single manageable bundle
- Abrasion protection for wires, cables, hoses and tubing
- Reusable
- Tool supplied in each package

## Suggested Applications



- Organize wires for communication and computer equipment where access to the wires is required
- In OEM applications for protecting tubes and harnesses
- Abrasion protection for control panel wiring
- Personal computer and printer wire organization
- Protect glass tubes from abrasion and breakage
- Kink-proofing for all kinds of tubing... ideal for laboratories
- Eliminates lacing cord and tie-offs
- Use orange or yellow spiral wrap for protecting and identifying fiber optic cables

**The Functional Part Number System Makes Ordering Easy**  
**Spiral Wrap Part Number Description**

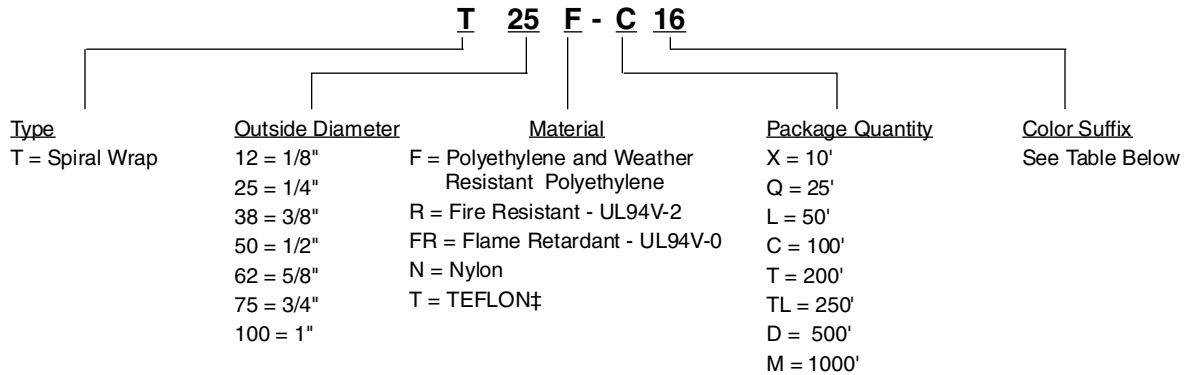

**Material Availability**

Color	Color Suffix*	Polyethylene	Weather Resistant Polyethylene	Fire Resistant Polyethylene	Flame Retardant Polyethylene	Nylon	Weather Resistant Nylon	TEFLON‡
Natural (Opaque to Translucent)	No Suffix will be listed	✓		✓ (Natural color is white)	✓ (Natural color is white)	✓		✓
Weather Resistant Black	0		✓				✓	
Brown	1	✓						
Red	2	✓						
Orange	3	✓						
Yellow	4	✓						
Green	5	✓						
Blue	6	✓						
Purple	7	✓						
Gray	8	✓						
White	10	✓						
Pink	16	✓						
Black	20			✓	✓			

Blank = Not applicable

\*Colors are stocked for 1/4" and 1/2" polyethylene. Other sizes available, contact PANDUIT® Technical Assistance 866-405-6657.

‡TEFLON or equivalent fluorocarbon PTFE material is used. TEFLON is a registered trademark of E.I. DuPont de Nemours Co.

# PANDUIT® Spiral Wrap

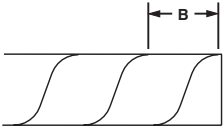

Part Number	Material	Color	A Outside Dia. in. (mm)	B in. (mm)	T in. (mm)	Bundle Size in. (mm)	Std. Pkg. Qty.* Ft. (m)						
<b>T12F-C</b>	Polyethylene	Natural	.125 (3.2)	.218 (5.5)	.03 (.76)	.064 (1.6) – .50 (12.7)	100 (30.5)						
<b>T19F-C</b>			.188 (4.8)	.250 (6.4)	.035 (.89)	.125 (3.2) – 1.00 (25.4)							
<b>T25F-X</b>		Brown White Pink Red Orange Yellow Green Blue Purple Gray	.25 (6.4)	.375 (9.5)	.04 (1.02)	.188 (4.8) – 2.00 (50.8)	100 (30.5)						
<b>T25F-C</b>													
<b>T25F-C1</b>													
<b>T25F-C10</b>													
<b>T25F-C16</b>													
<b>T25F-C2</b>													
<b>T25F-C3</b>													
<b>T25F-C4</b>													
<b>T25F-C5</b>													
<b>T25F-C6</b>													
<b>T25F-C7</b>													
<b>T25F-C8</b>													
<b>T38F-C</b>								Natural Brown White Pink Red Orange Yellow Green Blue Purple Gray	.375 (9.5)	.437 (11.1)	.055 (1.4)	.316 (7.9) – 3.00 (76.2)	10 (3.0)
<b>T50F-X</b>													
<b>T50F-C</b>		.50 (12.7)	.50 (12.7)	.06 (1.5)	.38 (9.5) – 4.00 (101.6)	100 (30.5)							
<b>T50F-C1</b>													
<b>T50F-C10</b>													
<b>T50F-C16</b>													
<b>T50F-C2</b>													
<b>T50F-C3</b>													
<b>T50F-C4</b>													
<b>T50F-C5</b>													
<b>T50F-C6</b>													
<b>T50F-C7</b>													
<b>T50F-C8</b>													
<b>T62F-C</b>							Natural		.625 (15.9)	.625 (15.9)	.062 (1.57)	.50 (12.7) – 4.50 (114.3)	
<b>T75F-C</b>	.75 (19.1)							.875 (22.2)	.065 (1.65)	.625 (15.9) – 5.00 (127.0)			
<b>T100F-C</b>	1 (25.4)							1.125 (28.6)	.07 (1.78)	.875 (22.2) – 6.00 (152.4)			
<b>T12F-C0</b>													
<b>T19F-C0</b>	Weather Resistant Polyethylene	Black	.125 (3.2)	.218 (5.5)	.03 (.760)	.064 (1.6) – .50 (12.7)	10 (3.0)						
<b>T25F-X0</b>			.188 (4.8)	.250 (6.4)	.035 (0.89)	.125 (3.2) – 1.00 (25.4)							
<b>T25F-C0</b>			.25 (6.4)	.375 (9.5)	.04 (1.02)	.188 (4.8) – 2.00 (50.8)		100 (30.5)					
<b>T38F-C0</b>			.375 (9.5)	.437 (11.1)	.055 (1.4)	.316 (7.9) – 3.00 (76.2)							
<b>T50F-X0</b>			.5 (12.7)	.5 (12.7)	.06 (1.5)	.375 (9.5) – 4.00 (101.6)		10 (3.0)					
<b>T50F-C0</b>													
<b>T62F-C0</b>			.625 (15.9)	.625 (15.9)	.062 (1.57)	.50 (12.7) – 4.50 (114.3)			100 (30.5)				
<b>T75F-C0</b>			.75 (19.1)	.875 (22.2)	.065 (1.65)	.625 (15.9) – 5.00 (127.0)							
<b>T100F-C0</b>			1 (25.4)	1.125 (28.6)	.07 (1.78)	.875 (22.2) – 6.00 (152.4)							

# PANDUIT® Spiral Wrap

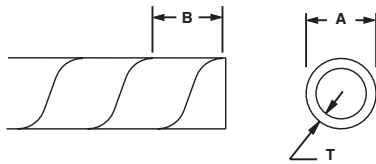

Part Number	Material	Color	A Outside Dia. in. (mm)	B in. (mm)	T in. (mm)	Bundle Size in. (mm)	Std. Pkg. Qty.* Ft. (m)
<b>T12R-C</b>	Fire Resistant Polyethylene UL94V-2	Natural	.125 (3.2)	.218 (5.5)	.03 (.76)	.064 (1.6) – .50 (12.7)	100 (30.5)
<b>T19R-C</b>		Natural	.188 (4.8)	.250 (6.4)	.035 (.89)	.125 (3.2) – 1.00 (25.4)	100 (30.5)
<b>T25R-C</b>		Natural	.25 (6.4)	.375 (9.5)	.04 (1.02)	.188 (4.8) – 2.00 (50.8)	100 (30.5)
<b>T25R-C20</b>		Black	.25 (6.4)	.375 (9.5)	.04 (1.02)	.188 (4.8) – 2.00 (50.8)	100 (30.5)
<b>T38R-C</b>		Natural	.375 (9.5)	.437 (11.1)	.055 (1.4)	.316 (7.9) – 3.00 (76.2)	100 (30.5)
<b>T50R-C</b>		Natural	.50 (12.7)	.50 (12.7)	.06 (1.5)	.375 (9.5) – 4.00 (101.6)	100 (30.5)
<b>T62R-C</b>		Natural	.625 (15.9)	.625 (15.9)	.062 (1.57)	.50 (12.7) – 4.50 (114.3)	100 (30.5)
<b>T75R-C</b>		Natural	.75 (19.1)	.875 (22.2)	.065 (1.65)	.625 (15.9) – 5.00 (127.0)	100 (30.5)
<b>T100R-C</b>		Natural	1.00 (25.4)	1.125 (28.6)	.07 (1.78)	.875 (22.2) – 6.00 (152.4)	100 (30.5)
<b>T12FR-C</b>	Flame Retardant Polyethylene UL94V-0	Natural	.125 (3.2)	.218 (5.5)	.03 (.76)	.064 (1.6) – .50 (12.7)	100 (30.5)
<b>T12FR-C20</b>		Black	.125 (3.2)	.218 (5.5)	.03 (.76)	.064 (1.6) – .50 (12.7)	100 (30.5)
<b>T19FR-C</b>		Natural	.188 (4.8)	.250 (6.4)	.032 (.81)	.125 (3.2) – 1.00 (25.4)	100 (30.5)
<b>T19FR-C20</b>		Black	.188 (4.8)	.250 (6.4)	.032 (.81)	.125 (3.2) – 1.00 (25.4)	100 (30.5)
<b>T25FR-C</b>		Natural	.25 (6.4)	.375 (9.5)	.04 (1.02)	.188 (4.8) – 2.00 (50.8)	100 (30.5)
<b>T25FR-C20</b>		Black	.25 (6.4)	.375 (9.5)	.04 (1.02)	.188 (4.8) – 2.00 (50.8)	100 (30.5)
<b>T38FR-C</b>		Natural	.375 (9.5)	.437 (11.1)	.055 (1.4)	.316 (7.9) – 3.00 (76.2)	100 (30.5)
<b>T38FR-C20</b>		Black	.375 (9.5)	.437 (11.1)	.055 (1.4)	.316 (7.9) – 3.00 (76.2)	100 (30.5)
<b>T50FR-C</b>		Natural	.50 (12.7)	.50 (12.7)	.06 (1.5)	.375 (9.5) – 4.00 (101.6)	100 (30.5)
<b>T50FR-C20</b>		Black	.50 (12.7)	.50 (12.7)	.06 (1.5)	.375 (9.5) – 4.00 (101.6)	100 (30.5)
<b>T62FR-C</b>		Natural	.625 (15.9)	.625 (15.9)	.062 (1.57)	.50 (12.7) – 4.50 (114.3)	100 (30.5)
<b>T62FR-C20</b>		Black	.625 (15.9)	.625 (15.9)	.062 (1.57)	.50 (12.7) – 4.50 (114.3)	100 (30.5)
<b>T75FR-C</b>		Natural	.75 (19.1)	.875 (22.2)	.065 (1.65)	.625 (15.9) – 5.00 (127.0)	100 (30.5)
<b>T75FR-C20</b>		Black	.75 (19.1)	.875 (22.2)	.065 (1.65)	.625 (15.9) – 5.00 (127.0)	100 (30.5)
<b>T100FR-C</b>		Natural	1.00 (25.4)	1.125 (28.6)	.07 (1.78)	.875 (22.2) – 6.00 (152.4)	100 (30.5)
<b>T100FR-C20</b>	Black	1.00 (25.4)	1.125 (28.6)	.07 (1.78)	.875 (22.2) – 6.00 (152.4)	100 (30.5)	
<b>T12N-C</b>	Nylon (Black is Weather Resistant Nylon)	Natural	.125 (3.2)	.218 (5.5)	.015 (.38)	.064 (1.6) – .50 (12.7)	100 (30.5)
<b>T12N-C0</b>		Black	.125 (3.2)	.218 (5.5)	.015 (.38)	.064 (1.6) – .50 (12.7)	100 (30.5)
<b>T19N-C</b>		Natural	.188 (4.8)	.250 (6.4)	.020 (.51)	.125 (3.2) – 1.00 (25.4)	100 (30.5)
<b>T19N-C0</b>		Black	.188 (4.8)	.250 (6.4)	.020 (.51)	.125 (3.2) – 1.00 (25.4)	100 (30.5)
<b>T25N-C</b>		Natural	.25 (6.4)	.375 (9.5)	.023 (.58)	.188 (4.8) – 2.00 (50.8)	100 (30.5)
<b>T25N-C0</b>		Black	.25 (6.4)	.375 (9.5)	.023 (.58)	.188 (4.8) – 2.00 (50.8)	100 (30.5)
<b>T38N-C</b>		Natural	.375 (9.5)	.437 (11.1)	.03 (.76)	.316 (7.9) – 3.00 (76.2)	100 (30.5)
<b>T38N-C0</b>		Black	.375 (9.5)	.437 (11.1)	.03 (.76)	.316 (7.9) – 3.00 (76.2)	100 (30.5)
<b>T50N-C</b>		Natural	.50 (12.7)	.50 (12.7)	.032 (.81)	.375 (9.5) – 4.00 (101.6)	100 (30.5)
<b>T50N-C0</b>		Black	.50 (12.7)	.50 (12.7)	.032 (.81)	.375 (9.5) – 4.00 (101.6)	100 (30.5)
<b>T62N-C</b>		Natural	.625 (15.9)	.625 (15.9)	.035 (.89)	.50 (12.7) – 4.50 (114.3)	100 (30.5)
<b>T62N-C0</b>		Black	.625 (15.9)	.625 (15.9)	.03 (.89)	.50 (12.7) – 4.50 (114.3)	100 (30.5)
<b>T75N-C</b>		Natural	.75 (19.1)	.875 (22.2)	.04 (1.02)	.625 (15.9) – 5.00 (127.0)	100 (30.5)
<b>T75N-C0</b>		Black	.75 (19.1)	.875 (22.2)	.04 (1.02)	.625 (15.9) – 5.00 (127.0)	100 (30.5)
<b>T100N-C</b>		Natural	1.00 (25.4)	1.125 (28.6)	.045 (1.1)	.875 (22.2) – 6.00 (152.4)	100 (30.5)
<b>T100N-C0</b>	Black	1.00 (25.4)	1.125 (28.6)	.045 (1.1)	.875 (22.2) – 6.00 (152.4)	100 (30.5)	
<b>T12T-C</b>	TEFLON‡	Natural	.125 (3.2)	.218 (5.5)	.02 (.5)	.064 (1.6) – .50 (12.7)	100 (30.5)
<b>T19T-C</b>		Natural	.188 (4.8)	.250 (6.4)	.03 (.76)	.125 (3.2) – 1.00 (25.4)	100 (30.5)
<b>T25T-L</b>		Natural	.25 (6.4)	.375 (9.5)	.03 (.76)	.188 (4.8) – 2.00 (50.8)	50 (15.2)
<b>T50T-Q</b>		Natural	.50 (12.7)	.50 (12.7)	.03 (.76)	.375 (9.5) – 4.00 (101.6)	25 (7.6)
<b>T62T-Q</b>		Natural	.625 (15.9)	.625 (15.9)	.03 (.76)	.50 (12.7) – 4.50 (114.3)	25 (7.6)
<b>T75T-X</b>		Natural	.75 (19.1)	.875 (22.2)	.03 (.76)	.625 (15.9) – 5.00 (127.0)	10 (3.0)
<b>T100T-X</b>		Natural	1.00 (25.4)	1.125 (28.6)	.04 (1.02)	.875 (22.2) – 6.00 (152.4)	10 (3.0)

\*Order in multiples of std. pkg. qty.

‡TEFLON or equivalent fluorocarbon PTFE material is used. TEFLON is a registered trademark of E.I. DuPont de Nemours Co.  
Note: Custom cut-to-length sizes are available upon request. Contact PANDUIT® Technical Assistance 866-405-6657 for details.

Most commonly used parts appear in **BOLD**

# PANDUIT® Split Harness Wrap

## PAN-WRAP™ Split Harness Wrap

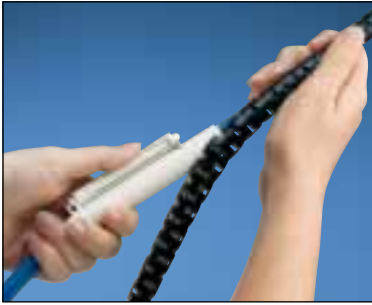

*PAN-WRAP™* Split Harness Wrap is an innovative addition to the *PANDUIT®* Abrasion Protection Line. Engineered for wire harness protection, *PAN-WRAP™* bundles and protects wire, cable and hoses. The *PAN-WRAP™* design provides full 360° coverage with pre-cut slots for break-outs to maximize reliability and reduce installation time. *PAN-WRAP™* tools are available for easy installation.

### Features and Benefits

- Slotted walls allow wire break-outs to speed installation
- Flexible design allows maneuverability and protects wire and cables during movement
- New installation tool reduces installation time and lowers installed cost
- 360° abrasion protection improves product reliability

### Applications

- Wire Harness Assemblers
- Commercial Appliances
- Transportation
- Industrial Robotics



Open *PAN-WRAP™* Tool to enable the wire bundle to be inserted inside the tool.



Insert wire bundle inside tool. Close tool to secure the wire bundle and prepare to insert bundle into the *PAN-WRAP™* Split Harness Wrap.



Insert end of tool into the end of Split Harness Wrap. Begin pulling the tool making certain that the Split Harness Wrap is feeding over the wire bundle.



Hold end of Split Harness Wrap and wire bundle while continuing to pull the tool, inserting the wire bundle into the length of the Split Harness Wrap.

### Split Harness Wrap

Part Number	Size I.D. In. (mm)	Maximum Bundle Diameter In. (mm)	Material	Color	Length Ft. (M)	Std. Pkg. Qty.*
PW50F-T	.50 (12.7)	.55 (13.97)	Polyethylene	Natural	200 (61.05)	1
PW75F-C	.75 (19.05)	.80 (20.32)	Polyethylene	Natural	100 (30.48)	1
PW50F-T20	.50 (12.7)	.55 (13.97)	Polyethylene	Black	200 (61.05)	1
PW75F-C20	.75 (19.05)	.80 (20.32)	Polyethylene	Black	100 (30.48)	1

### Tool

Part Number	Material	Color	Size	Std. Pkg. Qty.*
PWT50	ABS	White	.50"	1
PWT75	ABS	White	.75"	1



**Features:**

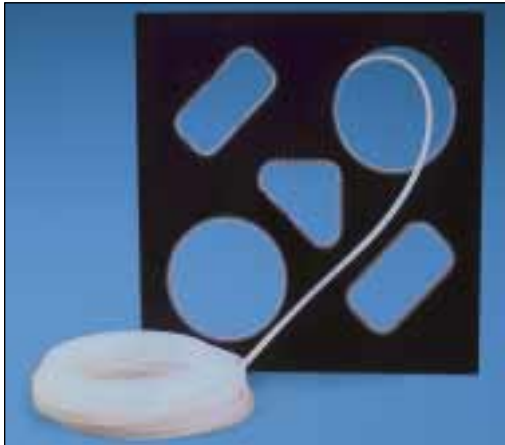

- Nylon grommet edging strips conform to the Military Standard MS21266
- Slotted or solid wall construction
- Available with pressure sensitive adhesive
- No liner to remove from adhesive

**Suggested Applications:**

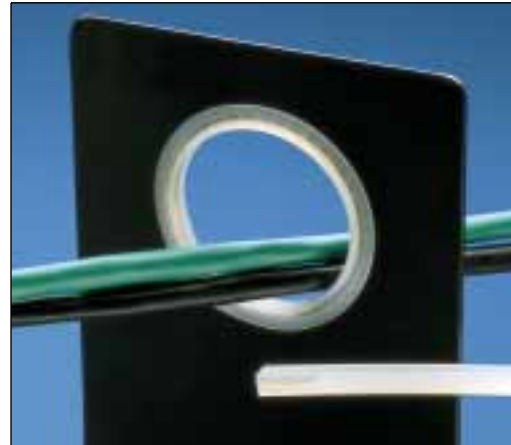

- Use the solid wall product on straight edges
- Use to prevent abrasion against the sharp edges of panel walls and knockouts

**The Functional Part Number System Makes Ordering Easy**  
**Grommet Edging Part Number Description**

**Example: GEE 36 F-A-C 0**

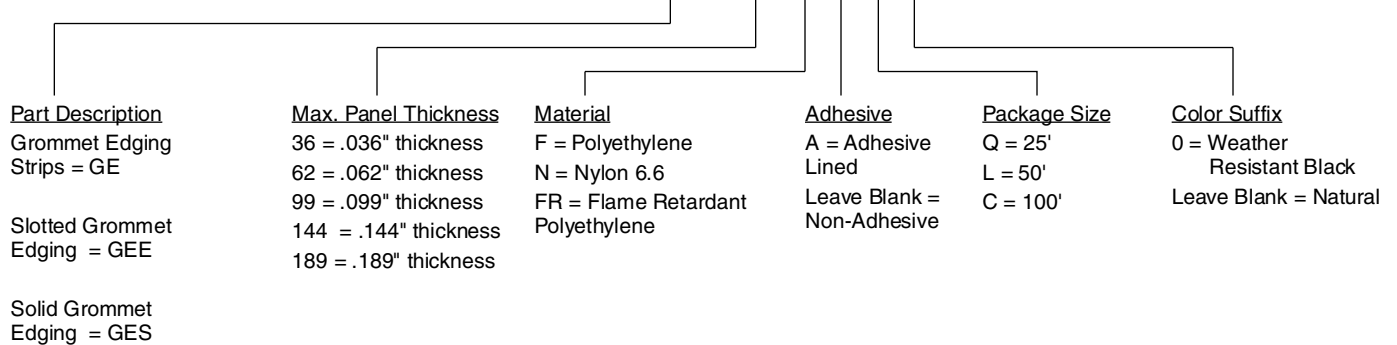

Protects wires and cables from sharp edges

## Choose from five materials:



### Nylon 6.6

- Self extinguishing
- For indoor use up to 149°F (65°C)
- Available with slotted wall only



### Polyethylene

- General purpose material for indoor use up to 122°F (50°C)
- Style GEE and GES provided in .030" (0.8mm) thick material, makes them highly flexible
- Available with slotted or solid wall construction



### Weather Resistant Polyethylene

- For outdoor use up to 122°F (50°C)
- Excellent resistance to ultra-violet light



### Flame Retardant Polyethylene

- Will not support a flame
- Available with slotted or solid wall construction



### Adhesive Lined Polyethylene

- Base is lined with a pressure sensitive adhesive
- Available in natural and weather resistant
- Adhesive ensures that the product will stay where it is installed

Adhesive Lined

Part Number	Material	Color	Panel Thickness in. (mm)	Dimensions—in. (mm)		Ft. (m) Per Roll	Std. Pkg. Qty.*
				A	B		
<b>GEE36F-C</b>	Continuous Polyethylene (Slotted Wall)	Natural	.026 (.7) – .036 (.9)	.106 (2.7)	.117 (3.0)	100 (30.5)	1 Roll
<b>GEE36F-C0</b>		Black	.026 (.7) – .036 (.9)	.106 (2.7)	.117 (3.0)	100 (30.5)	1 Roll
<b>GEE62F-C</b>		Natural	.036 (.9) – .062 (1.6)	.131 (3.3)	.160 (4.1)	100 (30.5)	1 Roll
<b>GEE62F-C0</b>		Black	.036 (.9) – .062 (1.6)	.131 (3.3)	.160 (4.1)	100 (30.5)	1 Roll
<b>GEE99F-C</b>		Natural	.062 (1.6) – .099 (2.5)	.169 (4.3)	.186 (4.7)	100 (30.5)	1 Roll
<b>GEE99F-C0</b>		Black	.062 (1.6) – .099 (2.5)	.169 (4.3)	.186 (4.7)	100 (30.5)	1 Roll
<b>GEE144F-C</b>		Natural	.099 (2.5) – .144 (3.7)	.213 (5.4)	.222 (5.6)	100 (30.5)	1 Roll
<b>GEE144F-C0</b>		Black	.099 (2.5) – .144 (3.7)	.213 (5.4)	.222 (5.6)	100 (30.5)	1 Roll
<b>GES36F-C</b>	Continuous Polyethylene (Solid Wall)	Natural	.026 (.7) – .036 (.9)	.106 (2.7)	.117 (3.0)	100 (30.5)	1 Roll
<b>GES36F-C0</b>		Black	.026 (.7) – .036 (.9)	.106 (2.7)	.117 (3.0)	100 (30.5)	1 Roll
<b>GES62F-C</b>		Natural	.036 (.9) – .062 (1.6)	.131 (3.3)	.160 (4.1)	100 (30.5)	1 Roll
<b>GES62F-C0</b>		Black	.036 (.9) – .062 (1.6)	.131 (3.3)	.160 (4.1)	100 (30.5)	1 Roll
<b>GES99F-C</b>		Natural	.062 (1.6) – .099 (2.5)	.169 (4.3)	.186 (4.7)	100 (30.5)	1 Roll
<b>GES99F-C0</b>		Black	.062 (1.6) – .099 (2.5)	.169 (4.3)	.186 (4.7)	100 (30.5)	1 Roll
<b>GES144F-C</b>		Natural	.099 (2.5) – .144 (3.7)	.213 (5.4)	.222 (5.6)	100 (30.5)	1 Roll
<b>GES144F-C0</b>		Black	.099 (2.5) – .144 (3.7)	.213 (5.4)	.222 (5.6)	100 (30.5)	1 Roll
<b>GES189F-C</b>	Natural	.144 (3.7) – .189 (4.8)	.297 (7.6)	.301 (7.7)	100 (30.5)	1 Roll	
<b>GES189F-C0</b>	Black	.144 (3.7) – .189 (4.8)	.297 (7.6)	.301 (7.7)	100 (30.5)	1 Roll	
<b>GEE62F-A-C</b>	Continuous Polyethylene With Adhesive (Slotted Wall)	Natural	.036 (.9) – .062 (1.6)	.131 (3.3)	.160 (4.1)	100 (30.5)	1 Roll
<b>GEE62F-A-C0</b>		Black	.036 (.9) – .062 (1.6)	.131 (3.3)	.160 (4.1)	100 (30.5)	1 Roll
<b>GEE99F-A-C</b>		Natural	.062 (1.6) – .099 (2.5)	.169 (4.3)	.186 (4.7)	100 (30.5)	1 Roll
<b>GEE99F-A-C0</b>		Black	.062 (1.6) – .099 (2.5)	.169 (4.3)	.186 (4.7)	100 (30.5)	1 Roll
<b>GEE144F-A-C</b>		Natural	.099 (2.5) – .144 (3.7)	.213 (5.4)	.222 (5.6)	100 (30.5)	1 Roll
<b>GEE144F-A-C0</b>		Black	.099 (2.5) – .144 (3.7)	.213 (5.4)	.222 (5.6)	100 (30.5)	1 Roll
<b>GES62F-A-C</b>	Continuous Polyethylene With Adhesive (Solid Wall)	Natural	.036 (.9) – .062 (1.6)	.131 (3.3)	.160 (4.1)	100 (30.5)	1 Roll
<b>GES62F-A-C0</b>		Black	.036 (.9) – .062 (1.6)	.131 (3.3)	.160 (4.1)	100 (30.5)	1 Roll
<b>GES99F-A-C</b>		Natural	.062 (1.6) – .099 (2.5)	.169 (4.3)	.186 (4.7)	100 (30.5)	1 Roll
<b>GES99F-A-C0</b>		Black	.062 (1.6) – .099 (2.5)	.169 (4.3)	.186 (4.7)	100 (30.5)	1 Roll
<b>GES144F-A-C</b>		Natural	.099 (2.5) – .144 (3.7)	.213 (5.4)	.222 (5.6)	100 (30.5)	1 Roll
<b>GES144F-A-C0</b>		Black	.099 (2.5) – .144 (3.7)	.213 (5.4)	.222 (5.6)	100 (30.5)	1 Roll
<b>GEE36FR-C</b>	Flame Retardant Polyethylene (Slotted Wall)	Natural	.026 (.7) – .036 (.9)	.106 (2.7)	.117 (3.0)	100 (30.5)	1 Roll
<b>GEE62FR-C</b>		Natural	.036 (.9) – .062 (1.6)	.131 (3.3)	.160 (4.1)	100 (30.5)	1 Roll
<b>GEE99FR-C</b>		Natural	.062 (1.6) – .099 (2.5)	.169 (4.3)	.155 (3.9)	100 (30.5)	1 Roll
<b>GEE144FR-C</b>		Natural	.099 (2.5) – .144 (3.7)	.213 (5.4)	.232 (5.9)	100 (30.5)	1 Roll
<b>GES36FR-C</b>	Flame Retardant Polyethylene (Solid Wall)	Natural	.026 (.7) – .036 (.9)	.106 (2.7)	.117 (3.0)	100 (30.5)	1 Roll
<b>GES62FR-C</b>		Natural	.036 (.9) – .062 (1.6)	.131 (3.3)	.160 (4.1)	100 (30.5)	1 Roll
<b>GES99FR-C</b>		Natural	.062 (1.6) – .099 (2.5)	.169 (4.3)	.155 (3.9)	100 (30.5)	1 Roll
<b>GES144FR-C</b>		Natural	.099 (2.5) – .144 (3.7)	.213 (5.4)	.232 (5.9)	100 (30.5)	1 Roll
<b>GEE47N-C</b>	Continuous Nylon 6.6 (Slotted Wall)	Natural	.039 (1.0) – .055 (1.4)	.130 (3.3)	.140 (3.5)	100 (30.5)	1 Roll
<b>GEE55N-C</b>		Natural	.047 (1.2) – .063 (1.6)	.133 (3.4)	.140 (3.5)	100 (30.5)	1 Roll
<b>GEE71N-C</b>		Natural	.063 (1.6) – .079 (2.0)	.150 (3.8)	.140 (3.5)	100 (30.5)	1 Roll
<b>GEE98N-C</b>		Natural	.091 (2.3) – .106 (2.7)	.180 (4.6)	.140 (3.5)	100 (30.5)	1 Roll
<b>GEE134N-C</b>		Natural	.126 (3.2) – .142 (3.6)	.210 (5.3)	.140 (3.5)	100 (30.5)	1 Roll

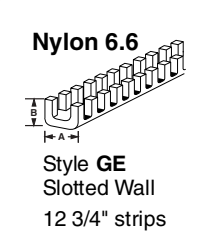
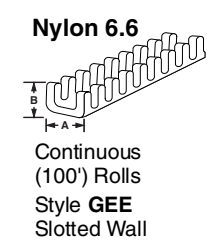
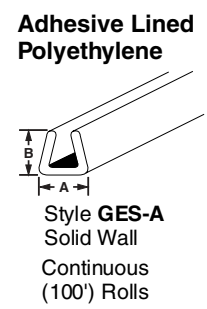
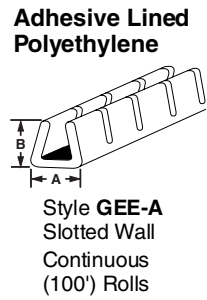
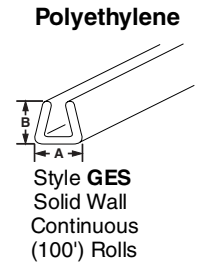
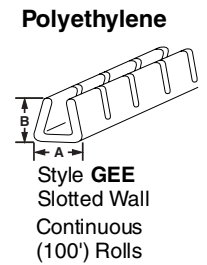

\*Order the number of reels required in multiples of standard package quantities.

Part Number	Material	Color	Panel Thickness in. (mm)	Dimensions—in. (mm)		Pieces Per Pkg.	Std. Pkg. Qty.*
				A	B		
<b>GE52-C</b>	Military Standard MS21266 12.75 (323.85mm) Nylon 6.6 Strips -69 designates Flame Retardant)	Natural	.015 (.4) – .052 (1.3)	.150 (3.8)	.155 (3.9)	100	Strips
<b>GE52-C69▲</b>		Natural	.015 (.4) – .052 (1.3)	.150 (3.8)	.155 (3.9)	100	Strips
<b>GE85-C</b>		Natural	.052 (1.3) – .085 (2.2)	.175 (4.5)	.155 (3.9)	100	Strips
<b>GE85-C69▲</b>		Natural	.05 (1.3) – .085 (2.2)	.175 (4.5)	.155 (3.9)	100	Strips
<b>GE128-C</b>		Natural	.085 (2.2) – .128 (3.3)	.220 (5.6)	.155 (3.9)	100	Strips
<b>GE128-C69▲</b>		Natural	.085 (2.2) – .128 (3.3)	.220 (5.6)	.155 (3.9)	100	Strips
<b>GE192-L</b>		Natural	.128 (3.3) – .192 (4.9)	.325 (8.3)	.230 (5.8)	50	Strips
<b>GE192-L69▲</b>		Natural	.128 (3.3) – .192 (4.9)	.325 (8.3)	.230 (5.8)	50	Strips
<b>GE255-L</b>		Natural	.192 (4.9) – .255 (6.5)	.385 (9.8)	.240 (6.1)	50	Strips
<b>GE318-L</b>		Natural	.255 (6.5) – .318 (8.1)	.455 (11.3)	.255 (6.5)	50	Strips
<b>GE380-Q</b>	Natural	.318 (8.1) – .380 (9.7)	.515 (13.1)	.255 (6.5)	25	Strips	
<b>GE510-Q</b>	Natural	.380 (9.7) – .510 (13.0)	.640 (16.3)	.255 (6.5)	25	Strips	

\*Order the number of pieces required in multiples of standard package quantities.

This material is not listed under military standard MS21266.

Grommet edging is to be used for odd shaped holes in addition to circular panel holes. Circular hole installation cut lengths can be found by: cut lengths = (dia. of hole) x 3.14.

Most commonly used parts appear in **BOLD**

# PANDUIT® Corrugated Loom Tubing



- PANDUIT® Corrugated Loom Tubing is offered for applications where spiral wrap or braided expandable sleeving may be difficult to install or where they do not offer the amount of protection required
- Available in Heat Stabilized Nylon or Polyethylene, this product features a lengthwise slit which makes it easy to install onto a bundle of wires or a pre-assembled harness assembly



## Features and Benefits

- Protects and reduces the risk of damage to wiring
- Crush, impact and abrasion resistant
- Slit wall design for ease of installation
- Available in easy to handle 100' lengths
- Available in black, orange and yellow polyethylene and black heat stabilized nylon
- Secure with push type cable ties, adhesive or push type mounts

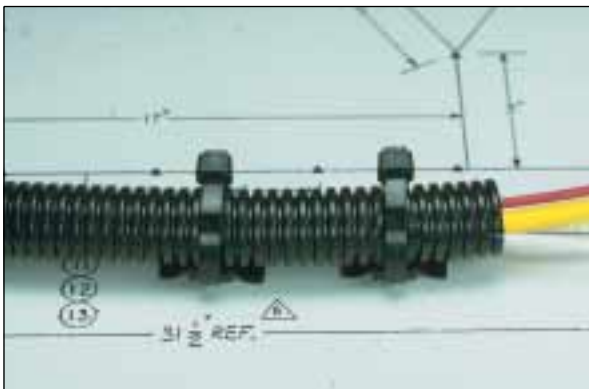

## Suggested Applications

- Bundle wires in control panels
- Contain and organize loose and bundled wiring harnesses
- Route wires in automotive, truck, trailer, bus, conversion van, emergency service and recreational vehicle applications
- Protect wires in off road/mobile equipment
- Use in mining equipment
- Marine applications for protecting wires on boats and ships



## Wiring Accessories for Corrugated Loom Tubing

- Tie Harness Mounts have a specially designed location tab on the mount that aligns with grooves in corrugated loom tubing to ensure proper mount location during assembly

The Functional Part Number System Makes Ordering Easy

Corrugated Loom Tubing Part Number Description

Example: **CLT 100 N-C 630**

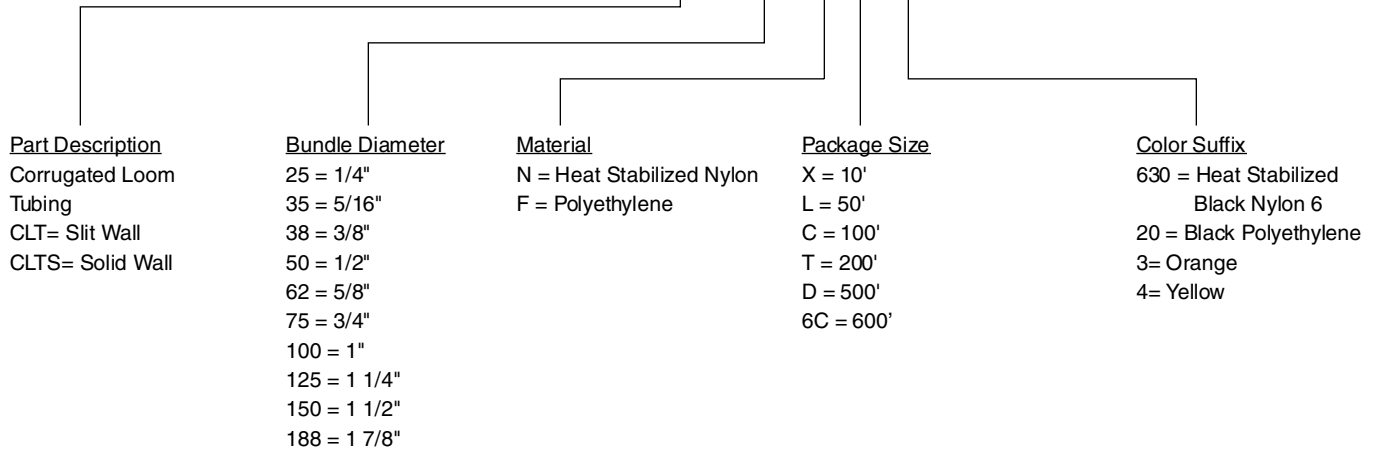

Part Number		Material	Color	Inside Diameter in. (mm)	Outside Diameter in. (mm)	Length Ft. (m)	Std. Pkg. Qty.*			
Slit	Solid									
<b>CLT25F-C20</b>	<b>CLTS25F-C</b>	Polyethylene	Black	.265 (6.7)	.390 (9.9)	100 (30.5)	1 Roll			
<b>CLT35F-C20</b>	<b>CLTS35F-C</b>			.350 (8.9)	.500 (12.7)	100 (30.5)				
<b>CLT38F-C20</b>	<b>CLTS38F-C</b>			.414 (10.5)	.556 (14.1)	100 (30.5)				
<b>CLT50F-C20</b>	<b>CLTS50F-C</b>			.505 (12.8)	.670 (17.0)	100 (30.5)				
<b>CLT62F-C20</b>	<b>CLTS62F-C</b>			.665 (16.9)	.830 (21.1)	100 (30.5)				
<b>CLT75F-C20</b>	<b>CLTS75F-C</b>			.760 (19.3)	.935 (23.7)	100 (30.5)				
<b>CLT100F-C20</b>	<b>CLTS100F-C</b>			.915 (23.2)	1.090 (27.7)	100 (30.5)				
<b>CLT125F-L20</b>	<b>CLTS125F-L</b>			1.290 (32.8)	1.500 (38.1)	50 (15.2)				
<b>CLT150F-X20</b>	**			1.550 (39.1)	1.860 (47.2)	10 (3.0)				
<b>CLT150F-T20</b>	**			1.550 (39.1)	1.860 (47.2)	200 (61.0)				
<b>CLT150F-D20</b>	<b>CLTS150F-D</b>			1.550 (39.1)	1.860 (47.2)	500 (152.4)				
<b>CLT188F-X20</b>	**			1.881 (47.8)	2.169 (55.1)	10 (3.0)				
<b>CLT188F-C20</b>	**			1.881 (47.8)	2.169 (55.1)	100 (30.5)				
<b>CLT188F-6C20</b>	**			1.881 (47.8)	2.169 (55.1)	600 (182.9)				
<b>CLT25F-C3</b>	<b>CLTS25F-C3</b>			Polyethylene	Orange	.265 (6.7)		.390 (9.9)	100 (30.5)	1 Roll
<b>CLT35F-C3</b>	<b>CLTS35F-C3</b>					.350 (8.9)		.500 (12.7)	100 (30.5)	
<b>CLT38F-C3</b>	<b>CLTS38F-C3</b>	.414 (10.5)	.556 (14.1)			100 (30.5)				
<b>CLT50F-C3</b>	<b>CLTS50F-C3</b>	.505 (12.8)	.670 (17.0)			100 (30.5)				
<b>CLT62F-C3</b>	<b>CLTS62F-C3</b>	.665 (16.9)	.830 (21.1)			100 (30.5)				
<b>CLT75F-C3</b>	<b>CLTS75F-C3</b>	.760 (19.3)	.935 (23.7)			100 (30.5)				
<b>CLT100F-C3</b>	<b>CLTS100F-C3</b>	.915 (23.2)	1.090 (27.7)			100 (30.5)				
<b>CLT125F-L3</b>	<b>CLTS125F-L3</b>	1.290 (32.8)	1.500 (38.1)			50 (15.2)				
<b>CLT150F-X3</b>	**	1.550 (39.1)	1.860 (47.2)			10 (3.0)				
<b>CLT150F-D3</b>	<b>CLTS150F-D3</b>	1.550 (39.1)	1.860 (47.2)			500 (152.4)				
<b>CLT188F-X3</b>	**	1.881 (47.8)	2.169 (55.1)			10 (3.0)				
<b>CLT188F-C3</b>	**	1.881 (47.8)	2.169 (55.1)	100 (30.5)						
<b>CLT150F-X4</b>	**	Polyethylene	Yellow	1.550 (39.1)	1.860 (47.2)	10 (3.0)	1 Roll			
<b>CLT150F-D4</b>	**			1.550 (39.1)	1.860 (47.2)	500 (152.4)				
<b>CLT188F-X4</b>	**			1.881 (47.8)	2.169 (55.1)	10 (3.0)				
<b>CLT188F-C4</b>	**			1.881 (47.8)	2.169 (55.1)	100 (30.5)				
<b>CLT25N-C630</b>	<b>CLTS25N-C</b>	Heat Stabilized Black Nylon 6	Black	.265 (6.7)	.390 (9.9)	100 (30.5)	1 Roll			
<b>CLT35N-C630</b>	<b>CLTS35N-C</b>			.350 (8.9)	.500 (12.7)	100 (30.5)				
<b>CLT38N-C630</b>	<b>CLTS38N-C</b>			.414 (10.5)	.556 (14.1)	100 (30.5)				
<b>CLT50N-C630</b>	<b>CLTS50N-C</b>			.505 (12.8)	.670 (17.0)	100 (30.5)				
<b>CLT62N-C630</b>	<b>CLTS62N-C</b>			.665 (16.9)	.830 (21.1)	100 (30.5)				
<b>CLT75N-C630</b>	<b>CLTS75N-C</b>			.760 (19.3)	.935 (23.7)	100 (30.5)				
<b>CLT100N-C630</b>	<b>CLTS100N-C</b>			.915 (23.2)	1.090 (27.7)	100 (30.5)				
<b>CLT125N-L630</b>	<b>CLTS125N-L</b>			1.290 (32.8)	1.500 (38.1)	50 (15.2)				
<b>CLT150N-D630</b>	**			1.550 (39.1)	1.860 (47.2)	500 (152.4)				
<b>CLT188N-6C630</b>	**			1.881 (47.8)	2.169 (55.1)	600 (182.9)				

\*Order number of rolls required.

\*\*Contact PANDUIT® Technical Assistance 866-405-6657 for additional sizes, materials, colors, and bulk packaging.

NOTE: Custom cut-to-length sizes are available upon request. Contact PANDUIT® Technical Assistance 866-405-6657 for details.

**WITH**  
PANDUIT Fittings



**WITHOUT**  
PANDUIT Fittings



**Features:**

- Fast assembly . . . . . Reduces production time
- Virtually eliminates taping . . . . . Improves system appearance
- Easy to assemble . . . . . Reduces operator fatigue
- Locking latch design . . . . . Secures fittings firmly in place
- Durable polyethylene shell. . . . . Protects wires
- Works with most popular sizes . . . . . Provides easy selection of fittings for application needs

**Benefits:**

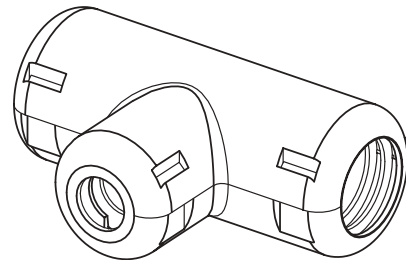
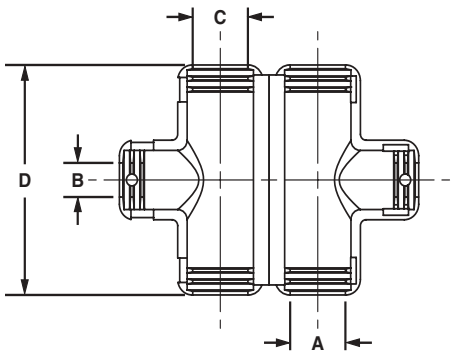

Part Number	Dimensions in. (mm)				Material	Color	Packaging*	
	A	B	C	D			Std. Pkg Qty.	Std. Ctn. Qty.
CF382538F-Q	.38 (9.53)	.25 (6.35)	.38 (9.53)	2.06 (52.32)	Polyethylene	Black	25	100
CF502550F-Q	.50 (12.70)		.50 (12.70)	2.30 (58.42)				
CF503850F-Q		.38 (9.53)	.75 (19.05)	3.06 (77.72)				
CF752575F-Q	.25 (6.35)							
CF753875F-Q	.75 (19.05)	.38 (9.53)						

**Braided Expandable Sleeving — Polyethylene Terephthalate — PET**



- Provides continuous abrasion resistance for wires, cables and tubing
- Lightweight, durable protection
- Highly flexible open weave will not trap heat or humidity
- Rated for use up to 257°F (125°C)
- Allows for use with irregular shapes
- Stock colors: Black, gray and white
- See [page 176](#) for cutting tools



**The Functional Part Number System Makes Ordering Easy**  
**Braided Expandable Sleeving Part Number Description**

**Example: SE 25 PFR-M R 0**

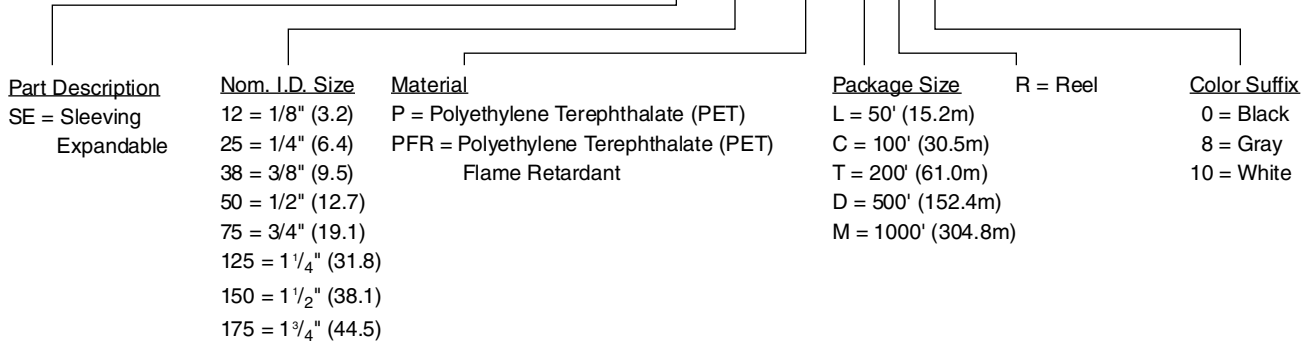

Part Number Black	Part Number Gray	Part Number White	Nominal I.D. in.	Nominal Diameter Range in. (mm)	Std. Pkg. Qty.* Feet (m)	Std. Ctn. Qty.
<b>SE12P-TR0</b> SE12P-MR0	SE12P-TR8 SE12P-MR8	— SE12P-MR10	1/8	.094 to .250 (2.4) to (6.4)	200 (61.0) 1000 (304.8)	4 Reels 2 Reels
<b>SE25P-TR0</b> SE25P-MR0	SE25P-TR8 SE25P-MR8	— SE25P-MR10	1/4	.125 to .375 (3.2) to (9.5)	200 (61.0) 1000 (304.8)	4 Reels 2 Reels
<b>SE38P-TR0</b> SE38P-MR0	SE38P-TR8 SE38P-MR8	— SE38P-MR10	3/8	.188 to .562 (4.7) to (14.3)	200 (61.0) 1000 (304.8)	4 Reels 2 Reels
<b>SE50P-CR0</b> SE50P-DR0	SE50P-CR8 SE50P-DR8	— SE50P-DR10	1/2	.250 to .750 (6.4) to (19.1)	100 (30.5) 500 (152.4)	4 Reels 2 Reels
<b>SE75P-CR0</b> SE75P-DR0	SE75P-CR8 SE75P-DR8	— SE75P-DR10	3/4	.500 to 1.25 (12.7) to (31.8)	100 (30.5) 500 (152.4)	4 Reels 2 Reels
<b>SE125P-LR0</b> SE125P-TR0	SE125P-LR8 SE125P-TR8	— SE125P-TR10	1 1/4	.750 to 1.50 (19.1) to (38.1)	50 (15.2) 200 (61.0)	4 Reels 2 Reels
<b>SE150P-LR0</b> SE150P-TR0	SE150P-LR8 SE150P-TR8	— SE150P-TR10	1 1/2	1.00 to 2.25 (25.4) to (57.2)	50 (15.2) 200 (61.0)	4 Reels 2 Reels
<b>SE175P-TR0</b>	—	—	1 3/4	1.25 to 2.75 (31.8) to (69.8)	200 (61.0)	2 Reels

\*Order number of reels required.

# PANDUIT® Flame Retardant Braided Expandable Sleeving

## Braided Expandable Sleeving — Flame Retardant Polyethylene Terephthalate — PET



- Provides continuous abrasion resistance for wires, cables and tubing
- Lightweight, durable protection
- Highly flexible open weave will not trap heat or humidity
- Rated for use up to 257°F (125°C)
- Allows for use with irregular shapes
- Self extinguishing, meets UL VW-1
- Stock colors: Black or gray with white tracer, or in white with black tracer to identify flame retardant material
- See bottom of this page for cutting tools



### Flame Retardant

Part Number Black	Part Number Gray	Part Number White	Nominal I.D. in. (mm)	Nominal Diameter Range in. (mm)	Std. Pkg. Qty. Feet (m)	Std. Ctn. Qty.
<b>SE12PFR-TR0</b> <b>SE12PFR-MR0</b>	SE12PFR-TR8 SE12PFR-MR8	— SE12PFR-MR10	1/8	.094 to .250 (2.4) to (6.4)	200 (61.0) 1000 (304.8)	4 Reels 2 Reels
<b>SE25PFR-TR0</b> <b>SE25PFR-MR0</b>	SE25PFR-TR8 SE25PFR-MR8	— SE25PFR-MR10	1/4	.125 to .375 (3.2) to (9.5)	200 (61.0) 1000 (304.8)	4 Reels 2 Reels
<b>SE38PFR-TR0</b> <b>SE38PFR-MR0</b>	SE38PFR-TR8 SE38PFR-MR8	— SE38PFR-MR10	3/8	.188 to .625 (4.7) to (15.9)	200 (61.0) 1000 (304.8)	4 Reels 2 Reels
<b>SE50PFR-CR0</b> <b>SE50PFR-DR0</b>	SE50PFR-CR8 SE50PFR-DR8	— SE50PFR-DR10	1/2	.250 to .750 (6.4) to (19.1)	100 (30.5) 500 (152.4)	4 Reels 2 Reels
<b>SE75PFR-CR0</b> <b>SE75PFR-DR0</b>	SE75PFR-CR8 SE75PFR-DR8	— SE75PFR-DR10	3/4	.500 to 1.25 (12.7) to (31.8)	100 (30.5) 500 (152.4)	4 Reels 2 Reels
<b>SE125PFR-LR0</b> <b>SE125PFR-TR0</b>	SE125PFR-LR8 SE125PFR-TR8	— SE125PFR-TR10	1 1/4	.750 to 1.50 (19.1) to (38.1)	50 (15.2) 200 (61.0)	4 Reels 2 Reels
SE150PFR-LR0 SE150PFR-TR0	SE150PFR-LR8 SE150PFR-TR8	— SE150PFR-TR10	1 1/2	1.00 to 2.25 (25.4) to (57.2)	50 (15.2) 200 (61.0)	4 Reels 2 Reels
SE175PFR-TR0	—	—	1 3/4	1.25 to 2.75 (31.8) to (69.8)	200 (61.0)	2 Reels

\*Order number of reels required.

### Tooling Head (HKBS)

Sleeving Cutter/End Sealer Blade —  
Used with popular soldering guns to cut and seal sleeving.



Part Number	Description	Std. Pkg. Qty*
HKBS	For dual straight shank soldering guns with .500" spacing Typical Guns: WELLER straight shank Model 8200; WEN Model 199 or 100	1

\*Order number of blades required.

### Bench Mount Cutter/ End Sealer

Available Directly from  
Manufacturer



Pearson Industries  
P.O. Box 36  
Prattville, AL 36067  
(334) 365-5416



**Abrasion Protection Products Flammability Tests and Classifications**

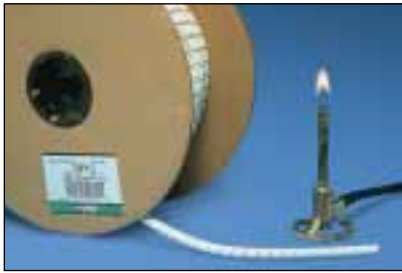

- A number of test procedures have been developed which can be used for the evaluation and comparison of various materials to support combustion
- Review the following classifications to find which category is designed to suit your abrasion and protection applications

**UL94 VERTICAL BURNING TEST**

Test samples of material, with dimension 125 ± 5mm by 13.0 ± 5mm and provided in the minimum and maximum thickness of the intended end use product, are tested in an unconditioned (as manufactured) state and in a conditioned state (7 days at 168F°, 75°C). The test requires the placement of a precisely controlled flame under a vertically supported specimen for a 10 second period. The flame is removed and the duration of flaming is recorded. If the flame extinguishes, the specimen is immediately subjected to a second 10 second ignition period. Duration of flaming is again recorded. A piece of 100% cotton is placed under the specimen. Also observed and documented is if the sample drips flaming particles that ignite the cotton indicator below.

**Materials Classification**

Criteria Conditions	V-0	V-1	V-2
Afterflame time for each individual specimen $t_1$ or $t_2$	≤10s	≤30s	≤30s
Total afterflame time for any condition set ( $t_1$ plus $t_2$ for the 5 specimens)	≤50s	≤250s	≤250s
Afterflame plus afterglow time for each individual specimen after the second flame application ( $t_2+t_3$ )	≤30s	≤60s	≤60s
Afterflame or afterglow of any specimen up to the holding clamp	No	No	No
Cotton indicator ignited by flaming particles or drops	No	No	Yes

$t_1$	Afterflame time after first flame application
$t_2$	Afterflame time after flame application
$t_3$	Afterglow time after second flame application

**MATERIALS CLASSIFIED UL-94 HB**

- Specimens shall have a maximum burn rate of <1.5"/min over 3" of thickness of 0.120" to 0.5"
- Specimens shall have a maximum burn rate of <3.0"/min over 3" for a thickness less than 0.120"

**UL224 VERTICAL WIRE FLAME TEST**

Samples of fully recovered tubing are placed over a length of fine spring steel music wire. The test requires the precise placement of a controlled flame that contacts the heat shrink tubing. The flame is applied in five fifteen second intervals with a time period between applications. If the flame extinguishes immediately after the first flame removal, subsequent flame applications are made to the tubing. Duration of specimen flaming is noted. A piece of surgical cotton is placed under the specimen. If a flaming or glowing piece of tubing drips and ignites the cotton, this is also noted.

**MATERIALS CLASSIFIED AS VW-1 SHALL:**

- Not flame or glow longer than 60 seconds following any of the five applications of the flame
- Not ignite or damage more than 25% of kraft paper flag that is placed around the top of the tubing
- Not have any specimens which drip flaming particles and ignite the surgical cotton located 9 1/2" below the test specimen.

## Abrasion Protection Materials Technical Data

	Ratings and Approvals			Physical Properties				Chemical Resistance				
	UL Temperature Index	Flammability (UL94)	Melting Temperature	Abrasion Resistance (lower number is better)	Specific Gravity (D792)	Minimum Tensile @ 23°C (psi)	Water Absorption (Max. 24 hrs.)	Organic Solvents	Alkalies	Acids	Petro-Chemicals	
<b>SPIRAL WRAP</b>	<b>Natural Polyethylene</b> Lowest cost material for indoor use up to 122°F. Natural is available in all sizes. Colors are available in 1/4" and 1/2".	-40°F (-40°C) to 122°F (50°C)	HB	239°F (115°C)	22 mg	.91-.93	1400 (D638)	.01%	Resistant below 140°F (60°C) except to chlorinated solvents	Resistant	Resistant except to oxidizing acids	Some Discoloration
	<b>Weather Resistant Polyethylene</b> This material has the same properties as natural polyethylene, and also has additives which allow it to resist the effects of ultraviolet light and acid rain in an outdoor environment. This product is available in black only.	-40°F (-40°C) to 122°F (50°C)	HB	239°F (115°C)	20 mg	.93-1.09	2000 (D638)	.03%	Resistant below 140°F (60°C) except to chlorinated solvents	Resistant	Resistant except to oxidizing acids	No Discoloration
	<b>Fire Resistant Polyethylene UL94-V2 Rating</b> This material is self extinguishing and passes the UL94 flame retardant test with a V2 rating.	-40°F (-40°C) to 122°F (50°C)	V-2	239°F (115°C)	27 mg	1.00-1.30	1400 (D638)	.02%	Resistant below 140°F (60°C) except to chlorinated solvents	Resistant	Resistant except to oxidizing acids	Some Discoloration
	<b>Flame Retardant Polyethylene UL94-V0 Rating</b> This material is self extinguishing and passes the UL94 flame retardant test with a V0 rating.	-40°F (-40°C) to 194°F (90°C)	UL94 V-0	270°F (132°C)	22 mg	1.15	1,500 (D638)	.02%	Resistant except to halogenated hydrocarbons	Resistant	Resistant	Resistant Some Discoloration
	<b>Nylon 6.6</b> Nylon is strong, durable, self-extinguishing material for indoor use up to 149°F. It offers a combination of lightweight, wide temperature range, and high abrasion resistance. This material is suitable for applications where heavy vibration or stress exists on the wiring or tubing.	-40°F (-40°C) to 149°F (65°C)	UL94 V-2	505°F (263°C)	7 mg	1.13-1.15	12,400 (D638)	1.2%	Resistant except to halogenated hydrocarbons	Resistant	Not recommended	Resistant No Discoloration
	<b>Weather Resistant Nylon</b> This material has the same properties as natural Nylon and also has additives which allow it to resist the effects of ultraviolet light in an outdoor environment. This product is available in black only.	-40°F (-40°C) to 149°F (65°C)	UL94 V-2	505°F (263°C)	7 mg	1.13-1.15	12,000 (D638)	1.2%	Resistant except to halogenated hydrocarbons	Resistant	Not recommended	Resistant No Discoloration
	<b>TEFLON†</b> This material is a non-flammable, fluorocarbon resin material. Suitable for use in any application (including nuclear containment). It is rated up to 356°F. Color: Opaque to Translucent	-400°F (-240°C) to 500°F (260°C)	UL94 V-0	648°F (342°C)	7 mg	2.13-2.22	3000 (D876)	.01%	Resistant	Resistant	Resistant	Resistant No Discoloration
<b>BRAIDED EXPANDABLE SLEEVING</b>	<b>Polyethylene Terephthalate (PET)</b> This material is a thermoplastic polyester material designed for indoor applications. It is rated for use up to 257°F and will tolerate short-term exposure up to 446°F. Colors: Black, White and Gray	-94°F (-70°C) to 257°F (125°C)	UL94 HB	500°F (260°C)	—	1.31	100.00 (D876)	.08%	Resistant to some solvents	Resistant to most weak bases	Resistant	Resistant No Discoloration
	<b>Flame Ret. Polyethylene Terephthalate (PET)</b> This material is a self-extinguishing thermoplastic polyester that can be used indoors. It is also rated for use up to 257°F and will tolerate short-term exposure up to 446°F. It is provided with tracers to identify the flame retardant material.	-94°F (-70°C) to 257°F (125°C)	UL 224 VW-1	608°F (320°C)	—	1.39	100.00 (D876)	.08%	Resistant to some solvents	Resistant to most weak bases	Resistant	Resistant No Discoloration

NOTE: Typical operating temperature ranges are extended based on end use application and specific environmental tests.

†TEFLON or equivalent fluorocarbon PTFE is used. Teflon is the registered trademark of E. I. DuPont de Nemours Co.

**Abrasion Protection Materials Technical Data**

		Ratings and Approvals			Physical Properties				Chemical Resistance			
		UL Temperature Index	Flammability (UL94)	Melting Temperature	Abrasion Resistance (Lower number is better)	Specific Gravity (D792)	Minimum Tensile @ 23°C (psi)	Water Absorption (Max. 24 hrs.)	Organic Solvents	Alkalies	Acids	Petro-Chemicals
<b>CORRUGATED LOOM TUBING</b>	<b>Black Polyethylene</b> Lowest cost material is for use up to 122°F. Other colors may be available.	-40°F (-40°C) to 122°F (50°C)	UL94 HB	—	—	.926-.940	1500 (D638)	—	Resistant except to halogenated hydrocarbons	Resistant	Resistant	Resistant No Discoloration
	<b>Nylon 6</b> Nylon is a strong, impact modified, heat stabilized, durable high abrasion resistant material.	-40°F (-40°C) to 230°F (110°C)	UL94 HB	410°F (211°C)	—	1.06-1.16	8000 (D638)	1.3%	Resistant except to halogenated hydrocarbons	Resistant	Not recommended	Resistant No Discoloration
<b>PVC TUBING</b>	<b>PVC Non-Shrink Tubing</b> This material provides insulation and protection for continuous use at temperatures -4°F (-20°C) to 221°F(105°C).	-4°F (-20°C) to 221°F (105°C)	UL 224 VW-1	—	—	1.35	2500 (D876)	—	Resistant except to aromatic hydrocarbons, ketones and esters	Resistant	Resistant	Resistant No Discoloration
<b>GROMMET EDGING</b>	<b>Natural Polyethylene</b> Lowest cost material for indoor use up to 122°F. Natural is available in all sizes.	-40°F (-40°C) to 122°F (50°C)	HB	239°F (115°C)	22 mg	.91-.93	1400 (D638)	.01%	Resistant below 140°F (60°C) except to chlorinated solvents	Resistant	Resistant except to oxidizing acids	Some Discoloration
	<b>Weather Resistant Polyethylene</b> This material has the same properties as natural polyethylene, and also has additives which allow it to resist the effects of ultraviolet light and acid rain in an outdoor environment. This product is available in black only.	-40°F (-40°C) to 122°F (50°C)	HB	239°F (115°C)	20 mg	.93-1.09	2000 (D638)	.03%	Resistant below 140°F (60°C) except to chlorinated solvents	Resistant	Resistant except to oxidizing acids	No Discoloration
	<b>Flame Retardant Polyethylene UL94-V0 Rating</b> This material is self extinguishing and passes the UL94 flame retardant test with a V0 rating	-40°F (-40°C) to 140°F (60°C)	V-0	270°F (132°C)	22 mg	1.38	1200	.02%	Resistant below 140°F (60°C) except to chlorinated solvents	Resistant	Resistant except to oxidizing acids	Some Discoloration
	<b>Nylon</b> Nylon is strong, durable, self-extinguishing material for indoor use up to 149°F. It offers a combination of lightweight, wide temperature range, and high abrasion resistance. This material is suitable for applications where heavy vibration or stress exists on the wiring or tubing.	-40°F (-40°C) to 149°F (65°C)	V-2	491°F (255°C)	7 mg	1.03-1.15	12,400 (D638)	1.5%	Resistant except to phenols and formic acid	Resistant	Resistant to most weak acids	No Discoloration

NOTE: Typical operating temperature ranges are extended based on end use application and specific environmental tests.

# PANDUIT® Abrasion Protection Products Technical Data

The approximate required length of spiral wrap based on the bundle diameter can be determined by using the graphs below; they show length required (in feet) per foot of bundle:

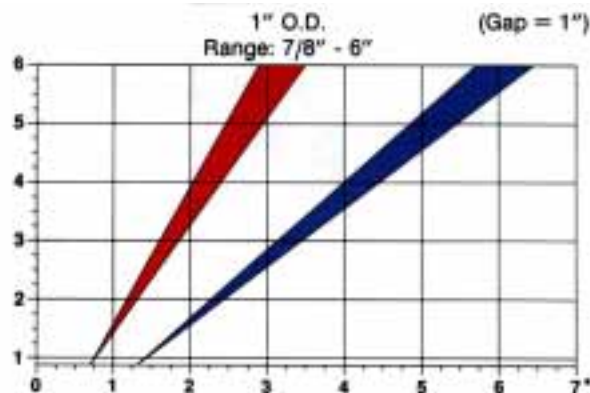
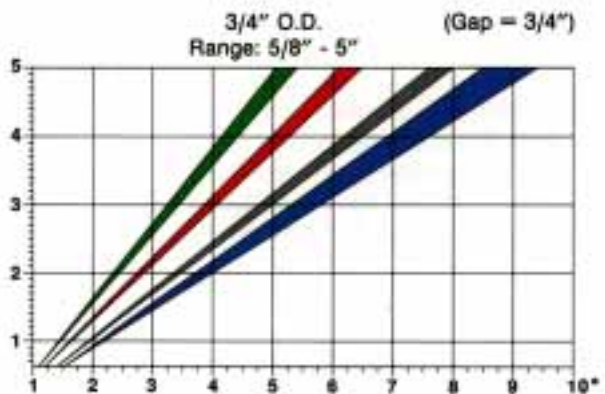
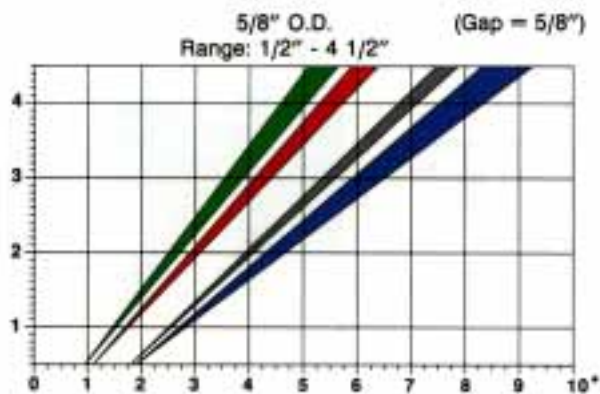
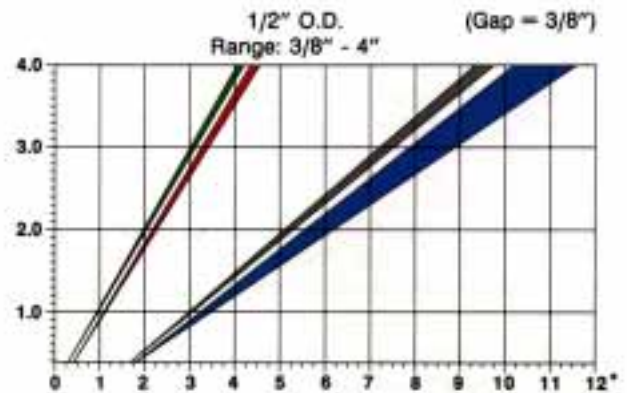
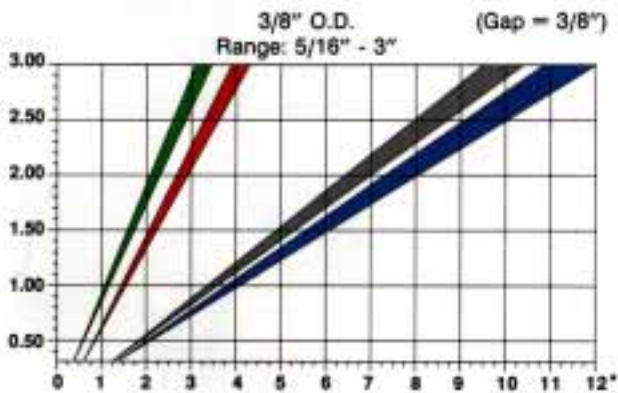
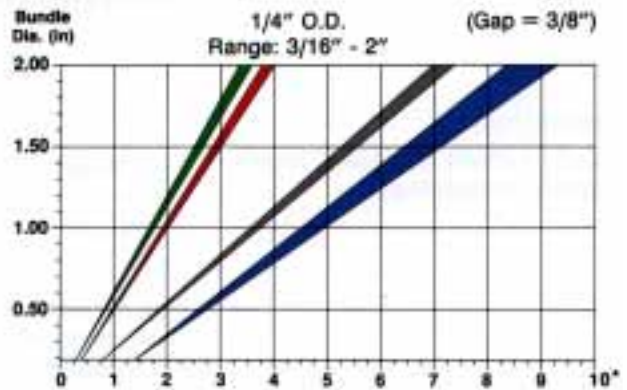
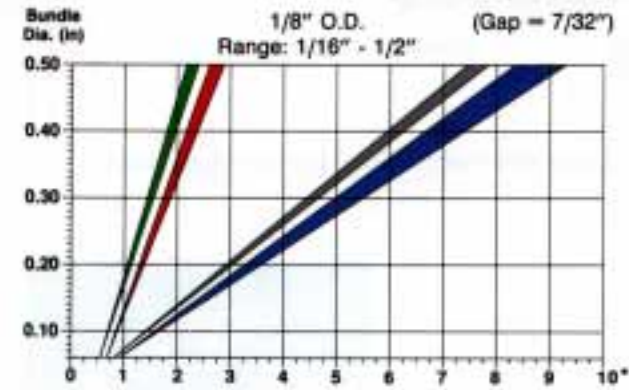

- = Polyethylene, Gapped
- = Polyethylene, Butted
- = Nylon, TEFLON®, Gapped
- = Nylon, TEFLON®, Butted

\* Length of spiral wrapping (feet) per foot of bundle  
 • TEFLON is a registered trademark of E.I. DuPont Co.

### Bulk Package Part Numbers

The following is an alpha-numeric cross reference of Standard Package Wiring Abrasion Protection parts with the corresponding Bulk Package part numbers:

Standard Part No.	Bulk Part No.
<b>C</b>	
CLT25N-C630	CLT25N-10M630
CLT35F-2C0	CLT35F-7M20
CLT38F-C20	CLT38F-5M20
CLT38N-C630	CLT38N-5M630
CLT50F-C20	CLT50F-4M20
CLT50N-C630	CLT50N-4M630
CLT62F-C20	CLT62F-2.5M20
CLT62N-C630	CLT62N-2.5M630
CLT75F-C20	CLT75F-2M20
CLT75N-C630	CLT75N-2M630
CLT100F-C20	CLT100F-125M20
CLT100N-C630	CLT100N-125M630
CLT125F-L20	CLT125F-.75M20
CLT125N-L630	CLT125N-.75M630
<b>T</b>	
T12F-C	T12F-D
T12N-C	T12N-D
T19N-C	T19N-M
T25F-C	T25F-M
T25F-C0	T25F-M0
T25FR-C	T25FR-M
T25FR-C20	T25FR-M20
T25N-C	T25N-M
T25N-C0	T25N-M0
T25R-C	T25R-M
T25R-C20	T25R-M20

Standard Part No.	Bulk Part No.
T38F-C	T38F-TL
T38F-C0	T38F-TL0
T38FR-C	T38FR-TL
T38N-C	T38N-TL
T38R-C	T38R-TL
T50F-C	T50F-TL
T50F-C0	T50F-TL0
T50F-C4	T50F-TL4
T50FR-C	T50FR-TL
T50N-C	T50N-TL
T50N-C0	T50N-TL0
T50R-C	T50R-TL
T62F-C	T62F-TL
T62F-C0	T62F-TL0
T75F-C	T75F-T
T75F-C0	T75F-T0
T75FR-C	T75FR-T
T75N-C	T75N-T

## PAN-TERM® Terminals, Disconnects and Splices



Designed and manufactured for fast assembly, long, reliable performance...

- Funnel entry available on vinyl and nylon insulated terminals and disconnects
- Made of electrolytically refined copper to provide optimum combination of crimp forming properties and low resistance, high conductivity terminations
- Offered in various types including rings, forks, locking forks and short locking forks
- Available sizes from 26 to 2 AWG and stud diameters from #2 to 1/2"
- Disconnects are available in many styles including fully insulated. Splices and wire joints provide permanent, reliable connections
- Wide assortment of manual, controlled cycle, battery operated and pneumatic crimping tools which give you reliable connections at a lower installed cost

Ask for PAN-TERM® Terminal, Disconnects and Splices/  
REEL SMART™ Termination Catalog — SA-TM09CB01A

## REEL SMART™ Continuously Molded Reel-Fed Terminals, Disconnects and Splices



“Reel” productivity assures high volume production at significant savings...

- ONE TECHNOLOGY, one solution for continuously molded Terminals, Butt Splices and Disconnects, including Fully Insulated Right Angle Female Disconnects and Pre-Assembled Locking Disconnects
- The REEL SMART™ Termination System for installing PANDUIT® continuously molded products provides the best solution for quality, reliable, high volume terminations
- This patented system offers an array of technical enhancements designed to dramatically reduce set-up time and the amount of downtime traditionally incurred with alternate systems
- Single, patented application terminates entire product line
- Applicators compatible with automatic wire processing machines and other manufacturer's presses

Ask for PAN-TERM® Terminal, Disconnects and Splices/  
REEL SMART™ Termination Catalog — SA-TM09CB01A

## Identification and Labeling Solutions



**PANDUIT® offers a complete line of industrial Identification Solutions...**

- **Computer Printable Labels**  
Thermal transfer, laser, ink jet and dot-matrix labels available in a wide variety of sizes and industrial materials
- **Printers**  
Versatile hand-held printers for on-site labeling and desktop thermal transfer printers for medium to high volume applications
- **Labeling Software**  
Labeling programs available for wire marking, component identification and safety markers and tags
- **Preprinted Markers**  
Available in books, cards, tape, slip-on and clip-on formats for fast, convenient identification of wires, cables and other industrial applications
- **Lockout/Tagout and Safety**  
Lockout devices, training materials, tags and safety markers for OSHA safety standard compliance

Ask for Identification Solutions Catalog **SA101N315C-ID**

## Network Connectivity Systems



The unique **PAN-NET® Network Connectivity System** provides high performance solutions with **FUTURE READY** features for system upgradability. Lowest installed cost solutions are available for both the enterprise and service provider markets...

- **Breadth of Product Offering**  
**PANDUIT®** supplies copper and fiber optic connectivity for reliable data, video and voice transmissions, end-to-end cable management for maximum protection and system integrity as well as standards compliance pathway and outlet products for maximum performance
- **Modular**  
All **PANDUIT® MINI-COM®** copper and fiber optic modules snap in and out of all **MINI-COM®** faceplates, surface mount boxes, patch panels and multimedia adapter panels

Ask for Network Connectivity Catalog **SA-NC10CB01A**

## PAN-WAY® Surface Raceway System



The superior **PAN-WAY®** Surface Raceway System offers the flexibility of accepting **PANDUIT®** communication and power devices in addition to devices offered from a wide range of manufacturers. The **PAN-WAY®** system has become the preferred routing system for communication and electrical specifiers and contractors...

- **Advanced Designs**

Among other features, all **PANDUIT®** cable routing pathways are designed to maintain the proper bend radius control for high performance copper and fiber optic cabling

- **Aesthetics**

Unlike raceway systems of the past, **PANDUIT®** perimeter raceway has been designed with as much regard to form as function

- **Superior Termination Solutions**

**PANDUIT®** cable routing solutions provide you freedom of choice when selecting your data and electrical outlets. Most **PANDUIT®** raceway systems accept both NEMA Standard "Screw-On" faceplates as well as superior **PANDUIT®** Snap-On faceplates for **PANDUIT®** Connectivity

- **Complete Systems**

All **PANDUIT®** systems include a full complement of fittings and accessories that allow a complete installation of a single system or allow different **PANDUIT®** raceway systems to be used together

Ask for **PAN-WAY®** Surface Raceway Catalog **SA101N60B-LP**

## PANDUCT® Wiring Duct — The Original Wiring Duct

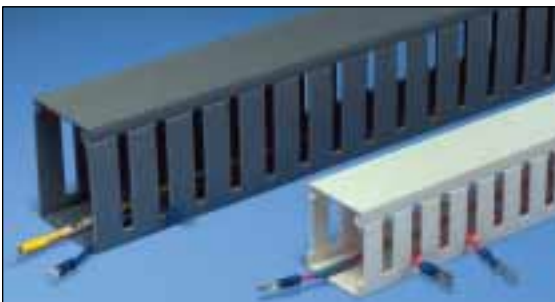

**PANDUIT®** offers the most comprehensive and complete line of wiring duct for use in control panels and other OEM and MRO applications. **PANDUIT®** provides a large selection of sizes, colors, styles and materials so our customers can meet their specific application requirements...

- **PANDUIT®** Exclusive rounded edges will not cut installers' hands or wiring insulation
- Non-slip cover will not slip when installed on duct base
- Flush cover design holds 10–12% more wires than traditional duct designs
- Double scoreline saves installation time and ultimately lowers installed cost
- Restricted slot design retains wire in slot for fast, easy wire installation or removal

Ask for **PANDUCT®** Wiring Duct Catalog **SA-WDCB05**

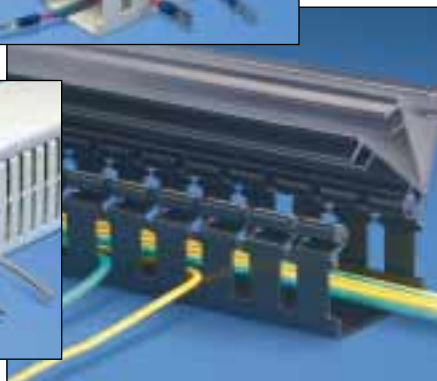



## Power Connectors



For applications in sizes #14 AWG through 1000 kcmil...

- **Compression Connectors**  
Provide reliable permanently crimped connections in sizes matched for each conductor size. They are easy to install and provide a simplified means of inspection of a proper crimp
- **Custom Lugs**  
*PANDUIT®* offers a wide variety of dimensional choices for #8 AWG to 250 kcmil copper compression lugs
- **Mechanical Connectors**  
Economical, reusable connectors in many styles in both copper and dual rated aluminum types
- **Power Connector Tooling**  
Includes hand operated controlled-cycle, mechanical and hydraulic crimping tools. Also available are the *UNI-DIE™* CT-980 dieless tool and revolutionary CT-2001 battery operated crimping tool



Ask for the *Termination Solutions Catalog SA-TMCB02*

**PANDUIT® offers a variety of custom programs designed to permanently identify PANDUIT® products for your specific application...**



- **Custom Marking**

All PANDUIT® stainless steel and brass products (ties, strapping, marker plates and tags) can be custom marked by one of two precise computer controlled systems (Laser or Embosser). These systems provide sharp, crisp, high quality legends. A variety of marking device accessories is also available for permanent identification of PANDUIT® stainless steel and brass products.

*For more information call 866-405-6659*

- **Hot Stamping**

PANDUIT® nylon cable ties, marker ties and marker plates can be custom identified to meet your specific requirements, including sequential numbering and specialized company logos (see page 52).

*For more information call 866-405-6660*



# PANDUIT® Alphanumeric Part Number Index

Part Number	Page Number
<b>A</b>	
A1C12-A-C8	110
A1C25-A-C8	110
A1C38-A-C8	110
A1C50-A-C8	110
A2C12-A-C8	110
A2C25-A-C8	110
A2C38-A-C8	110
A2C50-A-C8	110
<b>ABM1M-A-C</b>	<b>85</b>
ABM1M-AT-C	85
<b>ABM2S-A-C</b>	<b>86</b>
<b>ABM2S-AT-C</b>	<b>86</b>
<b>ABM2S-AT-C0</b>	<b>86</b>
ABM2S-S6-D	86
<b>ABM3H-A-L</b>	<b>86</b>
ABM3H-AT-L	86
ABM3H-S6-T	86
<b>ABM4H-A-L</b>	<b>86</b>
ABM4H-AT-L	86
ABM4H-S6-T	86
<b>ABM100-A-C</b>	<b>86</b>
ABM100-AT-C	86
ABM100-AT-C0	86
ABM100-S6-C	86
ABM100-S6-C69	86
<b>ABM112-A-C</b>	<b>86</b>
ABM112-AT-C	86
ABM112-AT-C0	86
ABM112-S6-C	86
ABM112-S6-C69	86
<b>ABMM-A-C</b>	<b>85</b>
ABMM-AT-C	85
ABMM-AT-C0	85
ABMM-D	86
ABMT-A-C	132
ABMT-A-C20	132
ABMT-S6-C	132
ABMT-S6-C20	132
ABMT-S6-C60	132
ABMT-S6-C69	132
ACC19-A-C	109
ACC19-A-C20	109
ACC19-AT-C	109
ACC19-AT-C0	109
<b>ACC38-A-C</b>	<b>109</b>
ACC38-A-C20	109
ACC38-AT-C	109
ACC38-AT-C0	109
ACC62-A-C	109
ACC62-A-C20	109
ACC62-AT-C	109
ACC62-AT-C0	109
ADCC31-AT-C10	112
AJC19-A-C	110
AJC25-A-C	110
AJC31-A-C	110
AJC38-A-C	110
AM2-C	92
AMC25-AT-C10	112
ARC.68-A-Q	108
ARC.68-A-Q14	108
ARC.68-S6-Q	108
ARC.68-S6-Q14	108
ASMS-A-X	88
AST10-5-C100	107
AST15-5-C100	107
AST20-5-C100	107
AST25-5-C100	107
<b>B</b>	
B2M2S-D	33
<b>B3M2S-TL</b>	<b>33</b>
<b>B4M2S-TL</b>	<b>33</b>
BC1M-S4-M	31
BC1.5I-S8-M	31
BC2M-S4-M	31
BC2S-S10-C	31
BC2S-S10-C0	31
BC3S-S10-C	31
BC3S-S10-D0	31
BC4LH-S25-L	31
BC4LH-S25-L0	31
BC4S-S10-C	31
BC4S-S10-C0	31
BEC38-A-L	112
BEC38-A-L20	112
BEC38-AT-L0	112
BEC62-A-L	112
BEC62-A-L20	112
BEC62-AT-L0	112
BEC75-A-L	112
BEC75-A-L20	112
BEC75-AT-L0	112

Part Number	Page Number
BECP38H25-L	112
BECP38H25-L20	112
BECP75H25-L	112
BECP75H25-L20	112
BF1M-C	32
<b>BF2M-C</b>	<b>32</b>
BM1M-C	32
<b>BM2M-C</b>	<b>32</b>
BM2S-C	32
<b>BM4S-C</b>	<b>32</b>
BR.5-E6-C	125
BR.75-E6-C	125
BR2-1.3-A-X	125
BR2-1.3-X	125
BR2-1.5-X	125
BR2-4-X	125
BR2-6-X	125
BT1HT	80
<b>BT1M-C</b>	<b>28</b>
<b>BT1M-C0</b>	<b>29</b>
BT1M-M39	30
<b>BT1.5I-C</b>	<b>28</b>
BT1.5I-C0	29
BT1.5I-M39	30
<b>BT1.5M-C</b>	<b>28</b>
<b>BT1.5M-C0</b>	<b>29</b>
<b>BT2I-C</b>	<b>28</b>
<b>BT2I-C0</b>	<b>29</b>
BT2LH-L	28
BT2LH-L0	29
<b>BT2M-C</b>	<b>28</b>
<b>BT2M-C0</b>	<b>29</b>
<b>BT2S-C</b>	<b>28</b>
<b>BT2S-C0</b>	<b>29</b>
BT2S-M39	30
<b>BT3I-C</b>	<b>28</b>
<b>BT3I-C0</b>	<b>29</b>
BT3LH-L	28
BT3LH-L0	29
<b>BT3S-C</b>	<b>28</b>
<b>BT3S-C0</b>	<b>29</b>
BT3S-M39	30
<b>BT4I-C</b>	<b>28</b>
<b>BT4I-C0</b>	<b>29</b>
<b>BT4LH-L</b>	<b>28</b>
<b>BT4LH-L0</b>	<b>29</b>
BT4LH-TL39	30
<b>BT4M-C</b>	<b>28</b>
<b>BT4M-C0</b>	<b>29</b>
<b>BT4S-C</b>	<b>28</b>
<b>BT4S-C0</b>	<b>29</b>
BT4S-M39	30
BT5LH-L	28
BT5LH-L0	29
BT6LH-L	28
BT6LH-L0	29
BT7LH-L	28
BT7LH-L0	29
BT8LH-L	28
BT8LH-L0	29
<b>BT9LH-L</b>	<b>28</b>
<b>BT9LH-L0</b>	<b>29</b>
<b>BW1.5I-D</b>	<b>30</b>
<b>BW2S-D</b>	<b>30</b>
<b>C</b>	
CBLS18-C	123
CBLS25-C	123
CBLS37-C	123
CBLS50-C	123
CBLS62-C	123
CBLS75-C	123
CBP12-C	122
CBP25-C	122
CBP31-C	122
CBP37-C	122
CBP50-C	122
CBP62-C	122
CBP75-C	122
CBP87-C	122
CBP100-C	122
<b>CBR1M-M</b>	<b>36</b>
<b>CBR1M-M0</b>	<b>36</b>
<b>CBR1.5I-M</b>	<b>36</b>
<b>CBR1.5I-M0</b>	<b>36</b>
<b>CBR1.5M-M</b>	<b>36</b>
<b>CBR1.5M-M0</b>	<b>36</b>
<b>CBR2HS-D</b>	<b>36</b>
<b>CBR2HS-D0</b>	<b>36</b>
<b>CBR2M-M</b>	<b>36</b>
<b>CBR2M-M0</b>	<b>36</b>
<b>CBR2S-M</b>	<b>36</b>
<b>CBR2S-M0</b>	<b>36</b>

Part Number	Page Number
<b>CBR3I-M</b>	<b>36</b>
<b>CBR3I-M0</b>	<b>36</b>
<b>CBR3S-M</b>	<b>36</b>
<b>CBR3S-M0</b>	<b>36</b>
<b>CBR4I-M</b>	<b>36</b>
<b>CBR4I-M0</b>	<b>36</b>
<b>CBR4LH-TL</b>	<b>36</b>
<b>CBR4LH-TL0</b>	<b>36</b>
<b>CBR4S-M</b>	<b>36</b>
<b>CBR4S-M0</b>	<b>36</b>
<b>CBR6LH-C</b>	<b>36</b>
<b>CBR6LH-C0</b>	<b>36</b>
CCH12-S10-C	117
CCH19-S10-C	117
<b>CCH25-S10-C</b>	<b>117</b>
CCH31-S10-C	117
<b>CCH38-S10-C</b>	<b>117</b>
CCH44-S10-C	117
<b>CCH50-S10-C</b>	<b>117</b>
CCH56-S10-C	117
CCH62-S10-C	117
CCH69-S10-C	117
CCH75-S10-C	117
CCH81-S10-C	117
CCH87-S10-C	117
CCH100-S10-C	117
CCH112-S10-C	117
CCH119-S10-C	117
CCH125-S10-C	117
CCH138-S10-C	117
CCH150-S10-C	117
CCMKIT1	133
CCS12-S8-C	117
CCS19-S8-C	117
<b>CCS25-S8-C</b>	<b>117</b>
CCS25-S10-C	117
CCS31-S8-C	117
CCS38-S8-C	117
CCS44-S8-C	117
CCS50-S8-C	117
CF382538F-Q	174
CF502550F-Q	174
CF503850F-Q	174
CF752575F-Q	174
CF753875F-Q	174
CH105-A-C14	113
CH105-S6-C14	113
CLT25F-C3	173
CLT25F-C20	173
CLT25N-C630	173
CLT35F-C3	173
CLT35F-C20	173
CLT35N-C630	173
CLT38F-C3	173
CLT38F-C20	173
CLT38N-C630	173
CLT50F-C3	173
CLT50F-C20	173
CLT50N-C630	173
CLT62F-C3	173
CLT62F-C20	173
CLT62N-C630	173
CLT75F-C3	173
CLT75F-C20	173
CLT75N-C630	173
CLT100F-C3	173
CLT100F-C20	173
CLT100N-C630	173
CLT125F-L3	173
CLT125F-L20	173
CLT125N-L630	173
CLT150F-D3	173
CLT150F-D4	173
CLT150F-D20	173
CLT150F-T20	173
CLT150F-X3	173
CLT150F-X4	173
CLT150F-X20	173
CLT150N-D630	173
CLT188F-6C20	173
CLT188F-C3	173
CLT188F-C4	173
CLT188F-C20	173
CLT188F-X3	173
CLT188F-X4	173
CLT188F-X20	173
CLT188N-6C630	173
CLTS25F-C	173
CLTS25F-C3	173
CLTS25N-C	173
CLTS35F-C	173
CLTS35F-C3	173
CLTS35N-C	173

# PANDUIT® Alphanumeric Part Number Index

Part Number	Page Number	Part Number	Page Number	Part Number	Page Number
CLTS38F-C	173	GE52-C	171	HLT3I-X0	40
CLTS38F-C3	173	GE52-C69	171	HLTP2I-X12	40
CLTS38N-C	173	GE85-C	171	HLTP3I-X12	40
CLTS50F-C	173	GE85-C69	171	HSC.25-L	119
CLTS50F-C3	173	GE128-C	171	HSC.25-L100	119
CLTS50N-C	173	GE128-C69	171	HSEC0.5-X, HSEC0.8-X	155
CLTS62F-C	173	GE192-L	171	HSEC1.0-X, HSEC1.5-5	155
CLTS62F-C3	173	GE192-L69	171	HSEC2.0-5, HSEC4.0-2	155
CLTS62N-C	173	GE255-L	171	HSG-115V-650	157
CLTS75F-C	173	GE318-L	171	HSG-A1	157
CLTS75F-C3	173	GE380-Q	171	HSG-A2	157
CLTS75N-C	173	GE510-Q	171	HSG-A3	157
CLTS100F-C	173	GEE36F-C	171	HSG-A4	157
CLTS100F-C3	173	GEE36F-C0	171	HSG-P1	157
CLTS100N-C	173	GEE36FR-C	171	HSG-P2	157
CLTS125F-L	173	GEE47N-C	171	HSG-P3	157
CLTS125F-L3	173	GEE55N-C	171	HSG-P7	157
CLTS125N-L	173	GEE62F-A-C	171	HST0.4-3-Q, HST0.4-48-5	154
CLTS150F-D	173	GEE62F-A-C0	171	HST0.4-6-3	154
CLTS150F-D3	173	GEE62F-C	171	HST0.4-6-X	154
CM4S-L2	49	GEE62F-C0	171	HST0.8-6-3, HST0.8-6-X, HST0.8-9-X,	
CM4S-L8	49	GEE62FR-C	171	HST0.8-12-5, HST0.8-48-5	154
CMVDR1	131	GEE71N-C	171	HST1.1-6-3, HST1.1-6-X, HST1.1-9-2,	
CMVDR1S	131	GEE98N-C	171	HST1.1-9-X, HST1.1-12-5, HST1.1-48-5	154
CMVDR2	131	GEE99F-A-C	171	HST1.5-9-X, HST1.5-12-1, HST1.5-12-5,	
CMVDR2S	131	GEE99F-A-C0	171	HST1.5-48-5	154
CMVDR3	131	GEE99F-C	171	HST2.0-9-5, HST2.0-12-2, HST2.0-48-2	154
CMWB	130	GEE99F-C0	171	HST3.0-12-2	154
CMWB10	130	GEE99FR-C	171	HST3.0-48-2	154
CMW-KIT	130	GEE134N-C	171	HSTT05-48-Q	141
CMW-KIT10	130	GEE144F-A-C	171	HSTT05-48-TL	141
CMWW	130	GEE144F-A-C0	171	HSTT05-C	141
CMWW10	130	GEE144F-C	171	HSTT05-M	141
CPH.75-S8-X	125	GEE144F-C0	171	HSTT05-Q	143
CPL.75-S8-X	125	GEE144FR-C	171	HSTT06-48-Q	141
CPM87S-C	102	GES36F-C	171	HSTT06-48-TL	141
CPM122S-C	102	GES36F-C0	171	HSTT06-C	141
CR2-M	104	GES36FR-C	171	HSTT06-M	141
CR4H-M	104	GES62F-A-C	171	HSTT06-Q	143
CR4H-M0	104	GES62F-A-C0	171	HSTT06-Y	143
CROS-M	104	GES62F-C	171	HSTT06-YK1	144
CRS1-125-X	131	GES62F-C0	171	HSTT09-48-Q	141
CRS1-X	131	GES62FR-C	171	HSTT09-48-TL	141
CRS4-125-X	131	GES99F-A-C	171	HSTT09-C	141
CRS6-X	131	GES99F-A-C0	171	HSTT09-M	141
CSCS-M	105	GES99F-C	171	HSTT09-Q	143
CSH-D0	105	GES99F-C0	171	HSTT09-Y	143
CSH-D20	105	GES99FR-C	171	HSTT09-YK1	144
		GES144F-A-C	171	HSTT12-48-Q	141
<b>D</b>		GES144F-A-C0	171	HSTT12-48-TL	141
DCT	157	GES144F-C	171	HSTT12-C	141
DHC1.12x1.75-D0	48	GES144F-C0	171	HSTT12-M	141
DT4EH-L0, DT8EH-Q0, DTREH-LR0,		GES144FR-C	171	HSTT12-Q	143
DTHEH-Q0, DTKEH-0	33	GES189F-C	171	HSTT12-Y	143
		GES189F-C0	171	HSTT12-YK1	144
<b>E</b>		GHH	59	HSTT19-48-Q	141
EMA-X	88	GS2B	55-56	HSTT19-48-TL	141
EMS-A-C	88	GS4EH	55-56	HSTT19-C	141
EMS-A-C0	88	GS4H	55-56	HSTT19-M	141
EMSK3-1-3-0	88	GS4H121W	55-56	HSTT19-Q	143
EMSK3-1-X0	88	GS4H/B	55-56	HSTT19-Y	143
EMSK12-4-12-X0	88	GS4MT	78	HSTT19-YK1	144
ER.5-E4-X	124	GTH	55-56	HSTT25-48-Q	142
ER1.25-E4-X	124	GTS	55-56	HSTT25-48-TL	142
				HSTT25-C	142
<b>F</b>				HSTT25-D	142
FCBI1-A-C20	103			HSTT25-Q	143
FCBI1-S10-C20	103	<b>H</b>		HSTT25-Y	143
FCBI2-A-C20	103	HB2SP19-X	129	HSTT25-YK1	144
FCBI2-S10-C20	103	HB2SP25-X	129	HSTT38-48-Q	142
FCBI3-A-C20	103	HB4SP19-X	129	HSTT38-48-TL	142
FCBI3-S10-C20	103	HB4SP25-X	129	HSTT38-C	142
FCC5-A-C8	115	HB6SP19-X	129	HSTT38-Q	143
FCC-A-C8	115	HBN.75-T	126	HSTT38-T	142
FCH2-A-C14	115	HBN1-T	126	HSTT38-Y	143
FCH2-S6-C14	115	HBN1.5-T	126	HSTT38-YK1	144
FCM1-A-C14	114	HBN2-T	126	HSTT50-48-Q	142
FCM1-S6-C14	114	HBN2.5-T	126	HSTT50-48-T	142
FCM1.2-A-C14	114	HBN3-T	126	HSTT50-C	142
FCM1.2-S6-C14	114	HBN4-T	126	HSTT50-Q	143
FCM2-A-C14	114	HCME06A12-C130	121	HSTT50-T	142
FCM2-S6-C14	114	HCMP06B12-C20	121	HSTT50-Y	143
FCM3.25-A-L14	114	HCMP06C12-C20	121	HSTT50-YK1	144
FCM3.25-S6-L14	114	HKBS	176	HSTT75-48-5	142
FCPH-C20	103	<b>HLC3S-X0</b>	40	HSTT75-48-CQ	142
FCPI2-C20	103	HLC5S-X0	40	HSTT75-C	142
FCPI3-C20	103	HLM-15R0	40	HSTT75-Q	143
FS156-C	127	HLS.15S-X0	40	HSTT75-T	142
FSH40-X	127	<b>HLS-15R0</b>	40	HSTT75-Y	143
FSHH-X	127	HLS3S-X0	40	HSTT75-YK1	144
		HLS5S-X0	40	HSTT100-48-5	142
<b>G</b>		HLS-75R0	40	HSTT100-48-LQ	142
GCTC3S-X0	41	<b>HLSP1.5S-X12</b>	40	HSTT100-C	142
GCTC5S-X0	41	HLSP3S-X12	40		
GCTE2S-X0	41	<b>HLSP5S-X12</b>	40		
GCTE4S-X0	41	HLT2I-X0	40		





# PANDUIT® Alphanumeric Part Number Index

Part Number	Page Number
PLT1M-L6-2	53
PLT1M-L6-4	53
PLT1M-L6-7	53
PLT1M-L6-10	61
PLT1M-L8	53
PLT1M-L8-0	53
PLT1M-L8-2	53
PLT1M-L8-4	53
PLT1M-L8-7	53
PLT1M-L8-10	53
PLT1M-M53	23
PLT1M-M54	23
PLT1M-M55	23
PLT1M-M59	23
<b>PLT1M-M69</b>	<b>20</b>
PLT1M-M100	19
PLT1M-M109	18
PLT1M-XMR	61
PLT1M-XMR0	61
PLT1M-XMR1	61
PLT1M-XMR2	61
PLT1M-XMR3	61
PLT1M-XMR4	61
PLT1M-XMR5	61
PLT1M-XMR6	61
PLT1M-XMR7	61
PLT1M-XMR8	61
PLT1M-XMR10	61
PLT1M-XMR30	61
PLT1S-C	6
PLT1S-C0	14
<b>PLT1.5I-C</b>	<b>6</b>
<b>PLT1.5I-C0</b>	<b>14</b>
PLT1.5I-M100	19
PLT1.5I-M109	18
PLT1.5I-M120	21
<b>PLT1.5I-M69</b>	<b>20</b>
<b>PLT1.5M-C</b>	<b>6</b>
<b>PLT1.5M-C0</b>	<b>14</b>
PLT1.5M-XMR	61
PLT1.5M-XMR0	61
PLT1.5M-XMR30	61
<b>PLT1.5S-C</b>	<b>6</b>
<b>PLT1.5S-C0</b>	<b>14</b>
PLT2EH-C	7
<b>PLT2EH-Q0</b>	<b>15</b>
PLT2H-L	7
<b>PLT2H-LO</b>	<b>15</b>
PLT2H-TL100	19
PLT2H-TL109	18
<b>PLT2I-C</b>	<b>6</b>
<b>PLT2I-C0</b>	<b>14</b>
PLT2I-C76	22
PLT2I-M53	23
PLT2I-M54	23
PLT2I-M55	23
PLT2I-M59	23
PLT2I-M69	20
<b>PLT2M-C</b>	<b>6</b>
<b>PLT2M-C0</b>	<b>14</b>
<b>PLT2M-M69</b>	<b>20</b>
<b>PLT2S-C</b>	<b>6</b>
<b>PLT2S-C0</b>	<b>14</b>
<b>PLT2S-C702</b>	<b>22</b>
<b>PLT2S-C76</b>	<b>22</b>
PLT2S-M53	23
PLT2S-M54	23
PLT2S-M55	23
PLT2S-M59	23
<b>PLT2S-M69</b>	<b>20</b>
<b>PLT2S-M100</b>	<b>19</b>
<b>PLT2S-M109</b>	<b>18</b>
<b>PLT2S-M120</b>	<b>21</b>
PLT2.5H-L	7
PLT2.5H-L0	15
PLT2.5I-C	6
PLT2.5I-C0	14
PLT2.5S-C	6
PLT2.5S-C0	14
<b>PLT3H-L</b>	<b>7</b>
<b>PLT3H-LO</b>	<b>15</b>
PLT3H-L76	22
PLT3H-TL100	19
PLT3H-TL109	18
<b>PLT3I-C</b>	<b>6</b>
<b>PLT3I-C0</b>	<b>14</b>
<b>PLT3S-C</b>	<b>6</b>
<b>PLT3S-C0</b>	<b>14</b>
PLT3S-C76	22
<b>PLT3S-C702</b>	<b>22</b>
PLT3S-M53	23
PLT3S-M54	23
PLT3S-M55	23

Part Number	Page Number
PLT3S-M59	23
<b>PLT3S-M100</b>	<b>19</b>
PLT3S-M109	18
<b>PLT4H-L</b>	<b>7</b>
<b>PLT4H-LO</b>	<b>15</b>
<b>PLT4H-L76</b>	<b>22</b>
PLT4H-TL69	20
<b>PLT4H-TL100</b>	<b>19</b>
PLT4H-TL109	18
PLT4H-TL120	21
<b>PLT4I-C</b>	<b>6</b>
<b>PLT4I-C0</b>	<b>14</b>
<b>PLT4S-C</b>	<b>6</b>
<b>PLT4S-C0</b>	<b>14</b>
<b>PLT4S-C76</b>	<b>22</b>
<b>PLT4S-M69</b>	<b>20</b>
PLT4S-M100	19
PLT4S-M109	18
PLT4S-M120	21
PLT4.5S-C	6
PLT4.5S-C0	14
<b>PLT5H-L</b>	<b>7</b>
<b>PLT5H-LO</b>	<b>15</b>
<b>PLT5EH-Q</b>	<b>7</b>
<b>PLT5EH-Q0</b>	<b>15</b>
PLT5S-C	6
PLT5S-C0	14
<b>PLT6H-L</b>	<b>7</b>
<b>PLT6H-LO</b>	<b>15</b>
<b>PLT6EH-Q</b>	<b>7</b>
<b>PLT6EH-Q0</b>	<b>15</b>
<b>PLT6LH-L</b>	<b>7</b>
PLT6LH-L0	15
<b>PLT7LH-L</b>	<b>7</b>
PLT7LH-L0	15
PLT8EH-C	7
PLT8EH-Q0	15
<b>PLT8H-L</b>	<b>7</b>
<b>PLT8H-LO</b>	<b>15</b>
PLT8LH-C120	21
PLT8LH-L	7
PLT8LH-L0	15
<b>PLT9LH-L</b>	<b>7</b>
<b>PLT9LH-LO</b>	<b>15</b>
<b>PLT10EH-C</b>	<b>7</b>
<b>PLT10EH-Q0</b>	<b>15</b>
<b>PLT10LH-L</b>	<b>7</b>
PLT12EH-C	7
PLT12EH-Q0	15
<b>PLT13H-Q</b>	<b>7</b>
PLT13H-Q0	15
<b>PLUP40S-D30</b>	<b>13</b>
<b>PLUP40SD-D30</b>	<b>13</b>
<b>PLWP1M-C</b>	<b>11</b>
<b>PLWP1S-C</b>	<b>11</b>
PLWP1SA-D	11
PLWP1SB-D	11
<b>PLWP1.5I-C</b>	<b>11</b>
PLWP1.5S-D	11
PLWP1.5SA-D	11
PLWP2H-TL	11
<b>PLWP2S-C</b>	<b>11</b>
PLWP2SA-D	11
PLWP2SB-D	11
<b>PLWP3H-TL</b>	<b>11</b>
<b>PLWP30SC-D30</b>	<b>12</b>
PLWP40SC-D30	12
<b>PLWP40SD-D30</b>	<b>12</b>
<b>PLWP50SC-D30</b>	<b>12</b>
PLWP50SE-D30	12
PM2H25-C	98
PM2H25-M0	98
PM2H25-M30	98
PMCC38H25-C	109
PMCC38H25-M0	109
PP1S-S10-X	102
PP1S-S12-X	102
PP2S-S10-X	102
PP2S-S12-X	102
PP5x50F	53
PPC25x50	53
PPC25x50F	53
PPF2S-S25-V	133
PPF2S-S25-V69	133
PPF2SV-S25-V	133
PPF2SV-S25-V69	133
PPH10	58
PPTEH	55, 58
<b>PPMT</b>	<b>78</b>
PPTS	55, 58
PRA2S-A-Q	87
PRLWP30S-D30	12
PRLWP50S-D30	12

Part Number	Page Number
PRST30S-S14-M30	46
PRT1S-C	8
PRT1S-C0	17
PRT1.5S-C	8
PRT1.5S-C0	17
PRT2EH-C	8
PRT2EH-Q0	16
PRT2H-L	8
PRT2H-LO	17
<b>PRT2S-C</b>	<b>8</b>
PRT2S-C0	17
PRT3H-L	8
PRT3H-LO	17
<b>PRT3S-C</b>	<b>8</b>
PRT3S-C0	17
<b>PRT4H-L</b>	<b>8</b>
PRT4H-LO	17
<b>PRT4S-C</b>	<b>8</b>
PRT4S-C0	17
PRT5EH-C100	19
<b>PRT5EH-Q</b>	<b>8</b>
<b>PRT5EH-Q0</b>	<b>16</b>
PRT6EH-C100	19
<b>PRT6EH-Q</b>	<b>8</b>
<b>PRT6EH-Q0</b>	<b>16</b>
PRT8EH-C	8
PRT8EH-Q0	16
PRT10EH-C	8
PRT10EH-Q0	16
PRT12EH-C	8
PRT12EH-Q0	16
PRWP1S-C	11
PRWP1SA-C	11
PRWP1SB-D	11
<b>PRWP1.5S-D</b>	<b>11</b>
PRWP2H-TL	11
<b>PRWP2S-D</b>	<b>11</b>
PTS	55, 58
PW50F-T	168
PW50F-T20	168
PW75F-C	168
PW75F-C20	168
PWMS-H25-C	98
PWMS-H25-M0	98
PWT50	168
PWT75	168
PX-0	105
PX-2	105
PX-10	105
<b>R</b>	
RAFCB1-S6-C20	103
RAFCB2-S6-C20	103
RAFCB3-S6-C20	103
RAMH-S10-D	96
RAMH-S6-D	96
RAMS-S3-M	96
RER.5E-X	124
RER.5-S6-X	124
RER.75E-X	124
RER.75-S6-X	124
RER1.25E-X	124
RER1.25-S6-X	124
<b>S</b>	
SACS50-T100	107
SE125PFR-LR0	176
SE125PFR-TR0	176
SE125PFR-LR8	176
SE125PFR-TR8	176
SE125P-LR0	175
SE125P-TR0	175
SE125P-LR8	175
SE125P-TR8	175
SE125P-TR10	175
SE12PFR-TR0	176
SE12PFR-MR0	176
SE12PFR-TR8	176
SE12PFR-MR8	176
SE12P-MR10	175
SE12P-TR0	175
SE12P-MR0	175
SE12P-TR8	175
SE12P-MR8	175
SE25PFR-LD-MR0	176
SE25PFR-MR0	176
SE25PFR-MR8	176
SE25PFR-TR0	176
SE25PFR-TR8	176
SE25PLD-MR0	175
SE25P-MR0	175
SE25P-MR8	175
SE25P-MR10	175
SE25P-TR0	175
SE25P-TR8	175

# PANDUIT® Alphanumeric Part Number Index

Part Number	Page Number
SE38PFR-MR0	176
SE38PFR-MR8	176
SE38PFR-TR0	176
SE38PFR-TR8	176
SE38P-MR0	175
SE38P-MR8	175
SE38P-MR10	175
SE38P-TR0	175
SE38P-TR8	175
SE50P-CR0	175
SE50P-CR8	175
SE50P-DR0	175
SE50P-DR8	175
SE50P-DR10	175
SE50PFR-CR0	176
SE50PFR-CR8	176
SE50PFR-DR0	176
SE50PFR-DR8	176
SE75P-CR0	175
SE75P-CR8	175
SE75P-DR0	175
SE75P-DR8	175
SE75P-DR10	175
SE75PFR-CR0	176
SE75PFR-CR8	176
SE75PFR-DR0	176
SE75PFR-DR8	176
SE150PFR-LR0	176
SE150PFR-LR8	176
SE150PFR-TR0	176
SE150PFR-TR8	176
SE150P-LR0	175
SE150P-LR8	175
SE150P-TR0	175
SE150P-TR8	175
SE150P-TR10	175
SE175PFR-TR0	176
SE175P-TR0	175
SHH1-S8-X	128
SHH3-S8-X	128
SICH25-C	120
SICH38-C	120
SICH50-C	120
SICH75-C	120
SICH100-C	120
SICH150-C	120
SMS-A-C	87
SMS-S6-D	87
SR2	54
SSC2S-S10-C	43
SSC4H-S25-L	43
<b>SSPM2.5H-L300</b>	<b>44</b>
SSPM2.5HP-L300	44
<b>SSPM4H-L300</b>	<b>44</b>
SSPM4HLP-TL300	44
<b>SSPM4HP-L300</b>	<b>44</b>
SST1M-C	43
SST1.5I-C	43
SST1.5M-C	43
SST2I-C	43
SST2S-C	43
SST3I-C	43
SST3S-C	43
SST4H-D	43
SST4S-C	43
SST8H-D	43
ST2EH	55, 57
<b>ST2MT</b>	<b>78</b>
STH2	55, 57
STHV	55, 57
STS2	55, 57

## T

T100F-C	166
T100F-C0	166
T12F-C	166
T12F-C0	166
T12FR-C	167
T12FR-C20	167
T19FR-C	167
T19FR-C20	167
T25FR-C	167
T25FR-C20	167
T38FR-C	167
T38FR-C20	167
T50FR-C	167
T50FR-C20	167
T62FR-C	167
T62FR-C20	167
T75FR-C	167
T75FR-C20	167
T100FR-C	167
T100FR-C20	167
T12N-C	167

Part Number	Page Number
T12N-C0	167
T12R-C	167
T19F-C	166
T19F-X0	166
T19N-C	167
T19N-C0	167
T19R-C	167
T19T-C	167
T12T-C	167
T25F-C	166
T25F-C0	166
T25F-C1	166
T25F-C2	166
T25F-C3	166
T25F-C4	166
T25F-C5	166
T25F-C6	166
T25F-C7	166
T25F-C8	166
T25F-C10	166
T25F-C16	166
T25F-X	166
T25F-X0	166
T25N-C	167
T25N-C0	167
T25R-C	167
T25R-C20	167
T25T-L	167
T38F-C	166
T38F-C0	166
T38N-C	167
T38N-C0	167
T38R-C	167
T50F-C	166
T50F-C0	166
T50F-C1	166
T50F-C2	166
T50F-C3	166
T50F-C4	166
T50F-C5	166
T50F-C6	166
T50F-C7	166
T50F-C8	166
T50F-C10	166
T50F-C16	166
T50F-X	166
T50F-X0	166
T50N-C	167
T50N-C0	167
T50R-C	167
T50T-Q	167
T62F-C	166
T62F-C0	166
T62N-C	167
T62N-C0	167
T62R-C	167
T62T-Q	167
T75F-C	166
T75F-C0	166
T75N-C	167
T75N-C0	167
T75R-C	167
T75T-X	167
T100N-C	167
T100N-C0	167
T100R-C	167
T100T-X	167
<b>TA1S8-C</b>	<b>93</b>
TA1S8-M0	93
TA1S8-M30	93
TA1S8-M69	93
TA1S10-C	93
TA1S10-M0	93
TA2-C	93
TC3-5-C100	118
TC5-7-C100	118
TC5x8-C100	118
TC6x10-C100	118
TC7-10-C100	118
TC7x14-C100	118
TC9x18-C100	118
TC10-14-C100	118
TC14-20-C100	118
THM1SC-C	101
THM1SC-C30	101
THMSC35-C630	100
THMSC35-C639	100
THMSC35F-C630	100
THMSC35F-C639	100
THMSP20-C	100
THMSP20F-C	100
THMSP20F-C30	100
THMSP25-C	100
THMSP25F-C	100

Part Number	Page Number
TJF-X	126
TM1A-C	92
TM1S4-C	89
TM1S6-C	89
TM2A-C	92
TM2PWH25-C	98
TM2R6-C	89
<b>TM2S6-C</b>	<b>89</b>
<b>TM2S8-C</b>	<b>89</b>
TM3A-C	92
TM3R6-C	89
<b>TM3S8-C</b>	<b>89</b>
<b>TM3S10-C</b>	<b>89</b>
TM3S25-C	89
TM3-X2-C0	90
TMEH25	90
TMEHS8	90
TMEH-S8-Q0	90
TMEHS10	90
TMEH-S10-C100	90
TMEH-S10-C109	90
TMEH-S10-Q0	90
TMEH-S25-Q0	90
TMEH-X2-L0	90
TMSH50-T300, TMSTHS10-D0, TMSTHS13-D0, TMSTHS16-D0, TMSTHS19-D0, TMSTLHS5-M0, TMSTLHS6-M0, TMSTLHS8-M0	91
TP2-C	95
TP4H-C	95
TRC18FR-X8	132
TTLK3	59
TV105-25TL, TV105-.25TL20, TV105-31TL, <b>TV105-31TL20, TV105-38TL, TV105-38TL20</b> , TV105-44TL, TV105-44TL20, TV105-50TL, <b>TV105-50TL20, TV105-56C, TV105-56C20</b> , TV105-63C, TV105-63C20, TV105-75C, <b>TV105-75C20, TV105-88C, TV105-88C20</b> , TV105-0TL, TV105-0TL20, TV105-1.0L, TV105-1.0L20, TV105-1.25L, TV105-1.25L20, TV105-1.50L, TV105-1.50L20, TV105-10D, TV105-10D20, TV105-11D, TV105-11D20, <b>TV105-12D, TV105-12D20, TV105-13M, TV105-13M20, TV105-14M, TV105-14M20</b> , TV105-15M, TV105-15M20, TV105-16M, TV105-16M20, TV105-17M, TV105-17M20, TV105-18M, TV105-18M20, TV105-19M, TV105-19M20, TV105-1TL, TV105-1TL20, TV105-20M, TV105-20M20, TV105-222.5M, TV105-222.5M20, TV105-242.5M, TV105-242.5M20, TV105-2TL, TV105-2TL20, TV105-3TL, TV105-3TL20, TV105-4TL, TV105-4TL20, TV105-5TL, TV105-5TL20, TV105-6TL, TV105-6TL20, TV105-7D, TV105-7D20, TV105-8D, TV105-8D20, TV105-9D, TV105-9D20	163
TWR-C	118
TWR-C0	118

## V

VCC25-A-C, VCC25-A-C20, VCC50-A-C	113
VSC.25-L	119
VSC.25-L100	119
VWS106-C	130
VWS106-C20	130
VWS42105-C, VWS4218-C, VWS4238-C, VWS4274-C	121
VWSDC-C	130

## W

WBS6-Q	122
WEH-E8-C	126
WPMH-C	99
WS25-25-C, WS25-50-C, WS25-75-C, WS35-25-C, WS35-50-CFB, WS35-75-C, WS50-25-C, WS50-50-C, WS50-75-C, WS75-25-C, WS75-50-C, WS75-75-C	120