

BNX005-11

In Production RoHS REACH

Appearance & Shape

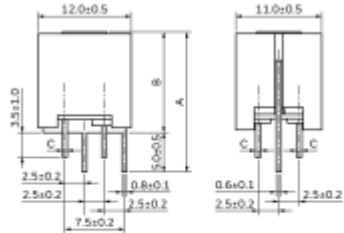

Part Number	A	B	C
BNX002-11	18.0 max.	12.5 max.	(ø0.6)
BNX003-11	18.0 max.	12.5 max.	(ø0.8)
BNX005-11	18.0 max.	13.0 max.	(ø1.0)

(in mm)

Features

The block type "EMIFIL" BNX series incorporates through-type capacitor, monolithic chip capacitors and bead. The BNX is high performance for use in DC power circuits.

Features

1. The filter enables obtaining high insertion loss in wide frequency ranges from 0.5MHz to 1GHz.
2. Effective for impulse noise such as electrostatic discharge or spike noise.
3. There are no connection routes in the current circuits, thus ensuring highly reliable performance.

Applications

1. Displays (PDP/LCD-TV)
2. Digital A/V equipment
3. Amusement equipment
4. PC peripheral equipment
5. Industry equipment

Applications

Other Usage	For general
-------------	-------------

Packaging Information

Packaging	Specifications	Minimum Order Quantity
-	Box	100

Attention

1. This datasheet is downloaded from the website of Murata Manufacturing Co., Ltd. Therefore, its specifications are subject to change or our products in it may be discontinued without advance notice. Please check with our sales representatives or product engineers before ordering.
2. This datasheet has only typical specifications because there is no space for detailed specifications. Therefore, please review our product specifications or consult the approval sheet for product specifications before ordering.

BNX005-11

Specifications

Shape	Lead
Length	12.0mm
Length Tolerance	±0.5mm
Width	11.0mm
Width Tolerance	±0.5mm
Thickness	13.0mm
Thickness Tolerance	max.
Rated Current	15A
Operating Temperature Range	-40°C to 85°C
Mass(typ.)	3.3g
Rated Voltage	50Vdc
Withstanding Voltage	125Vdc
Insulation Resistance(min.)	100MΩ
Insertion Loss	1MHz to 1GHz:40dB min. (Line impedance=50Ω)

Attention

1.This datasheet is downloaded from the website of Murata Manufacturing Co., Ltd. Therefore, it's specifications are subject to change or our products in it may be discontinued without advance notice. Please check with our sales representatives or product engineers before ordering.

2.This datasheet has only typical specifications because there is no space for detailed specifications.

Therefore, please review our product specifications or consult the approval sheet for product specifications before ordering.

BNX005-11

Product Data

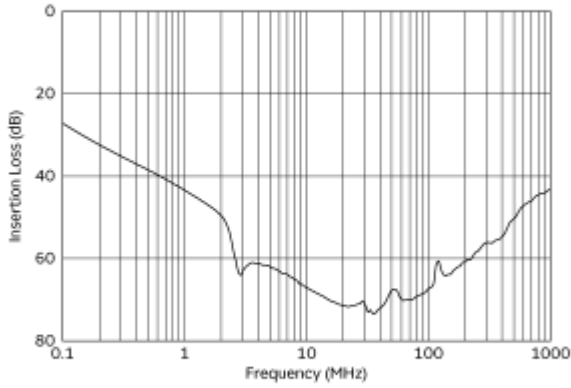

Insertion Loss Characteristics

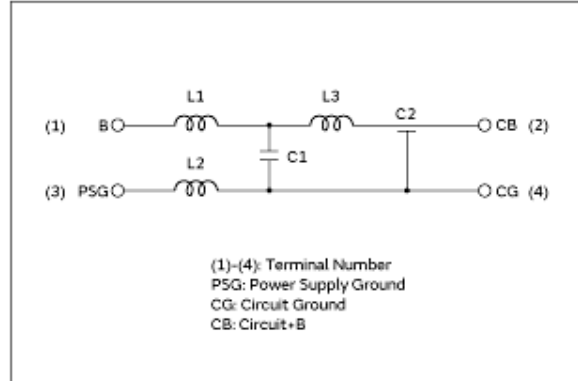

Equivalent Circuit

Attention

- 1.This datasheet is downloaded from the website of Murata Manufacturing Co., Ltd. Therefore, it's specifications are subject to change or our products in it may be discontinued without advance notice. Please check with our sales representatives or product engineers before ordering.
- 2.This datasheet has only typical specifications because there is no space for detailed specifications.
Therefore, please review our product specifications or consult the approval sheet for product specifications before ordering.