

BLC Series - Basic Compact Pressure Sensor Series

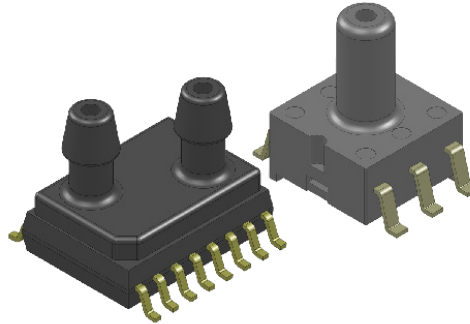

Table of Contents

Features & Applications	2
Standard Pressure Ranges	2
Pressure Sensor Maximum Ratings	2
Environmental Specifications	2
Performance Characteristics	3
Soldering Recommendations	3
How to Order Guide	4
Product Identification Guide	5
Dimensional Package Drawings	
Single Top Port DIP and SMT Gage	6
No Port SMT Absolute	7
Dual Port Same Side Logged SMT Differential	8
Dual Port Opposite Side SML Differential	8
Dual Port Top Side SOIC Differential	9
Pressure Tubing Recommendations	10
Suggested Pad Layouts	11

Introduction

The BLC Series Basic Low Pressure Compact Sensor is based on All Sensors' CoBeam²™ Technology. The device provides a high output signal at a low operating voltage and reduces the overall supply voltage while maintaining comparable output levels to traditional equivalent basic sensing elements. This lower supply voltage gives rise to improved warm-up shift while the CoBeam² Technology itself reduces package stress susceptibility resulting in improved overall long term stability. The technology also vastly improves position sensitivity compared to conventional single die devices.

This series is intended for use with non-corrosive, non-ionic working fluids such as air, dry gases and the like. The output is also ratiometric to the supply voltage and is operable from 0.9 to 1.8 volts DC.

<https://www.allsensors.com/products/blc-series>



BLC SERIES BASIC COM[ACT] PRESSURE SENSORS

Features

- 0 to 1 inH2O to 0 to 30 inH2O, 5 PSI to 150 PSI, and 5 PSIA to 150 PSIA Pressure Ranges
- μ Power Low Supply Voltage (0.9V to 1.8V)
- 0.1% Linearity Typical
- Improved Front to Back Linearity
- Less Position Sensitivity
- Improved Warm-Up Shift Distribution

Applications

- Medical Instrumentation
- Environmental Controls
- HVAC
- Portable / Hand-Held Devices

Standard Pressure Ranges

Low Pressure Products

Device	Operating Range ^A		Proof Pressure		Burst Pressure	
BLC-L01D	± 1 inH2O	248.84 Pa	100 inH2O	24.88 kPa	300 inH2O	74.65 kPa
BLC-L05D	± 5 inH2O	1,244.20 Pa	200 inH2O	49.77 kPa	300 inH2O	74.65 kPa
BLC-L10D	± 10 inH2O	2,488.40 Pa	200 inH2O	49.77 kPa	300 inH2O	74.65 kPa
BLC-L20D	± 20 inH2O	4,976.80 Pa	200 inH2O	49.77 kPa	500 inH2O	124.42 kPa
BLC-L30D	± 30 inH2O	7,465.20 Pa	200 inH2O	49.77 kPa	500 inH2O	124.42 kPa

High Pressure Products

Device	Operating Range ^A		Proof Pressure		Burst Pressure	
BLC-005D	± 5 psi	34.47 kPa	10 psi	68.95 kPa	15 psi	103.42 kPa
BLC-015D	± 15 psi	103.42 kPa	30 psi	206.84 kPa	45 psi	310.26 kPa
BLC-030D	± 30 psi	206.84 kPa	60 psi	413.69 kPa	90 psi	620.53 kPa
BLC-100D	± 100 psi	689.48 kPa	200 psi	1,378.95 kPa	225 psi	1,551.32 kPa
BLC-150D	± 150 psi	1,034.20 kPa	225 psi	1,551.32 kPa	225 psi	1,551.32 kPa
BLC-015A	0 to 15 psia	1.03 barA	30 psi	2.06 barA	45 psi	3.10 barA
BLC-030A	0 to 30 psia	2.06 barA	60 psi	4.14 barA	90 psi	6.20 barA
BLC-100A	0 to 100 psia	6.89 barA	200 psi	13.79 barA	225 psi	15.51 barA
BLC-150A	0 to 150 psia	10.34 barA	225 psi	15.51 barA	225 psi	15.51 barA

Note A: Operating range in Pa is expressed as an approximate value.

Pressure Sensor Maximum Ratings		Environmental Specifications	
Supply Voltage (Vs)	6 Vdc	Temperature Ranges	
Common Mode Pressure	5 psig	Operating	-25°C to 85°C
Lead Temperature (soldering 2-4 sec.)	270°C	Storage	-40°C to 125°C
		Humidity Limits (non condensing)	0 to 95% RH

Performance Characteristics for BLC Series

ALL PARAMETERS ARE MEASURED AT 1.8V EXCITATION AND ROOM TEMPERATURE UNLESS OTHERWISE SPECIFIED. PRESSURE MEASUREMENTS ARE WITH POSITIVE PRESSURE APPLIED. PRESSURE MEASUREMENTS ARE WITH POSITIVE PRESSURE APPLIED TO PORT B (THE ONLY PORT FOR THE SINGLE PORT CONFIGURATION.)

Parameter	Min	Typ	Max	Units	Notes
Output Span (FSS)					
L01D	4.5	8.0	11.5	mV	4
L05D	13.5	24.0	34.5	mV	4
L10D	18.0	32.0	46.0	mV	4
L20D	22.0	38.0	55.0	mV	4
L30D	25.0	42.0	60.0	mV	4
005D	18.0	25.2	32.4	mV	4
015D	46.8	61.2	75.6	mV	4
030D	25.2	36.0	46.8	mV	4
100D	27.0	36.0	45.0	mV	4
150D	40.7	54.0	67.7	mV	4
015A	46.8	61.2	75.6	mV	4
030A	25.2	36.0	46.8	mV	4
100A	25.2	36.0	46.8	mV	4
150A	40.7	54.0	67.7	mV	4
Offset Voltage					
L01D, L05D, L10D, L20D, L30D (@ Zero Diff. Pressure)	-	-	±10.0	mV	-
005D, 015D, 030D, 100D, 150D, 030A, 100A, 150A	-	-	±30.0	mV	-
015A (@ 0 PSIA)	-	-	±15.0	mV	-
Offset Temperature Shift (0°C-70°C)					
	-	±30.0	-	μV/°C	
Offset Warm-up Shift					
	-	±30.0	-	μV	-
Offset Position Sensitivity (1g)					
	-	±20.0	-	μV	-
Linearity, Hysteresis Error					
L01D, L05D, L10D, L20D, L30D	-	-	±0.50	%FSS	-
005D, 015D, 030D, 100D, 150D, 015A, 030A, 100A, 150A	-	-	±0.30	%FSS	-
Response Time (10% to 90% Pressure Response)					
	-	100	-	μS	-
Front to Back Linearity					
	-	0.25	-	%FSS	-
Temperature Effect on Resistance (0°C-70°C)					
	-	2800	-	ppm/°C	-
Temperature Effect on Span (0°C-70°C)					
	-	-2000	-	ppm/°C	-
Input Resistance					
L01D, L05D, L10D, L20D, L30D (@ Zero Diff. Pressure)	-	3.4	-	kΩ	-
005D, 015D, 030D, 100D, 150D, 030A, 100A, 150A	-	5.0	-	kΩ	-
015A (@ 0 PSIA)	-	5.5	-	kΩ	-
Output Resistance					
L01D, L05D, L10D, L20D, L30D (@ Zero Diff. Pressure)	-	3.4	-	kΩ	-
005D, 015D, 030D, 100D, 150D, 030A, 100A, 150A	-	5.0	-	kΩ	-
015A (@ 0 PSIA)	-	5.5	-	kΩ	-

Specification Notes

NOTE 1: SHIFT IS RELATIVE TO 25°C.

NOTE 2: SHIFT IS WITHIN THE FIRST HOUR OF EXCITATION APPLIED TO THE DEVICE.

NOTE 3: MEASURED AT ONE-HALF FULL SCALE RATED PRESSURE USING BEST STRAIGHT LINE CURVE FIT.

NOTE 4: THE SPAN IS THE ALGEBRAIC DIFFERENCE BETWEEN FULL SCALE OUTPUT VOLTAGE AND THE OFFSET VOLTAGE.

$$Lin_{FB} = \left(\left| \frac{Span_{PortB}}{Span_{PortA}} \right| - 1 \right) \cdot 100\%$$

NOTE 5: FRONT-BACK LINEARITY COMPUTED AS:

NOTE 6: TYPICAL WARM UP OF CHARACTERISTICS AS SHOWN BELOW.

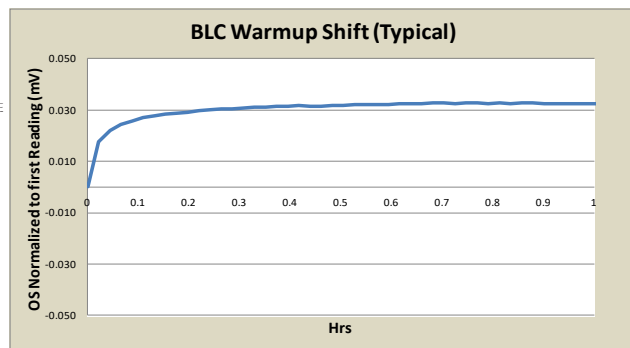

Soldering Recommendations

- 1) Solder parts as a second operation only.
- 2) For D4 package post reflow, wait for 72 hrs before performing any calibration operations.
- 3) For all other packages post reflow, wait for 36 hrs before performing any calibration operations.
- 4) Perform spot cleaning as necessary only by hand. DO NOT wash or submerge device in cleaning liquid.
- 5) Vapor phase reflow processes are not compatible with D1 and D3 packages.

How To Order

Refer to Table 1 for configuring a standard base part number which includes the pressure range and package.

Example P/N with options: BLC-L01D-D4

Table 1 - How to Configure a Part Number

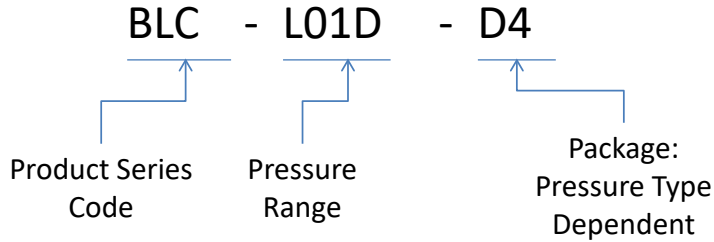

Where:

Pressure Range (D1, D3, D4 Packages — Differential Only): L01D, L05D, L10D, L20D, L30D, 005D, 015D, 030D, 100D, 150D

Pressure Range (U1, U2 Package — Gage Only): L01D, L05D, L10D, L20D, L30D, 005D, 015D, 030D, 100D, 150D

Pressure Range (U4 Package — Absolute Only): 015A, 030A, 100A, 150A

Table 2 - Standard Part Number Configurations

D Packages (Differential)	Low Pressure Products	BLC - L01 D - D1	BLC - L01 D - D3	BLC - L01 D - D4
	High Pressure Products	BLC - L05 D - D1	BLC - L05 D - D3	BLC - L05 D - D4
		BLC - L10 D - D1	BLC - L10 D - D3	BLC - L10 D - D4
		BLC - L20 D - D1	BLC - L20 D - D3	BLC - L20 D - D4
		BLC - L30 D - D1	BLC - L30 D - D3	BLC - L30 D - D4
				BLC - 005 D - D4
				BLC - 015 D - D4
				BLC - 030 D - D4
				BLC - 100 D - D4
				BLC - 150 D - D4
U Packages (Gage)	Low Pressure Products	BLC - L01 D - U1	BLC - L01 D - U2	
	High Pressure Products	BLC - L05 D - U1	BLC - L05 D - U2	
		BLC - L10 D - U1	BLC - L10 D - U2	
		BLC - L20 D - U1	BLC - L20 D - U2	
		BLC - L30 D - U1	BLC - L30 D - U2	
		BLC - 005 D - U1	BLC - 005 D - U2	
		BLC - 015 D - U1	BLC - 015 D - U2	
		BLC - 030 D - U1	BLC - 030 D - U2	
		BLC - 100 D - U1	BLC - 100 D - U2	
		BLC - 150 D - U1	BLC - 150 D - U2	
U Package (Absolute)	High Pressure Products	BLC - 015 A - U4		
		BLC - 030 A - U4		
		BLC - 100 A - U4		
		BLC - 150 A - U4		



Product Identification on backside of device

All products are labeled via laser marking as seen in Figure 1.

Figure 2 details how to interpret the part marking code. Low pressure ranges from 1 to 30 inH2O are specified with code "L" and high pressure products in from 5 to 150 psi with code "H".

The pressure range will be indicated on the same line as the wafer number before the starting character "B".

Example: BLC-L05D-D4

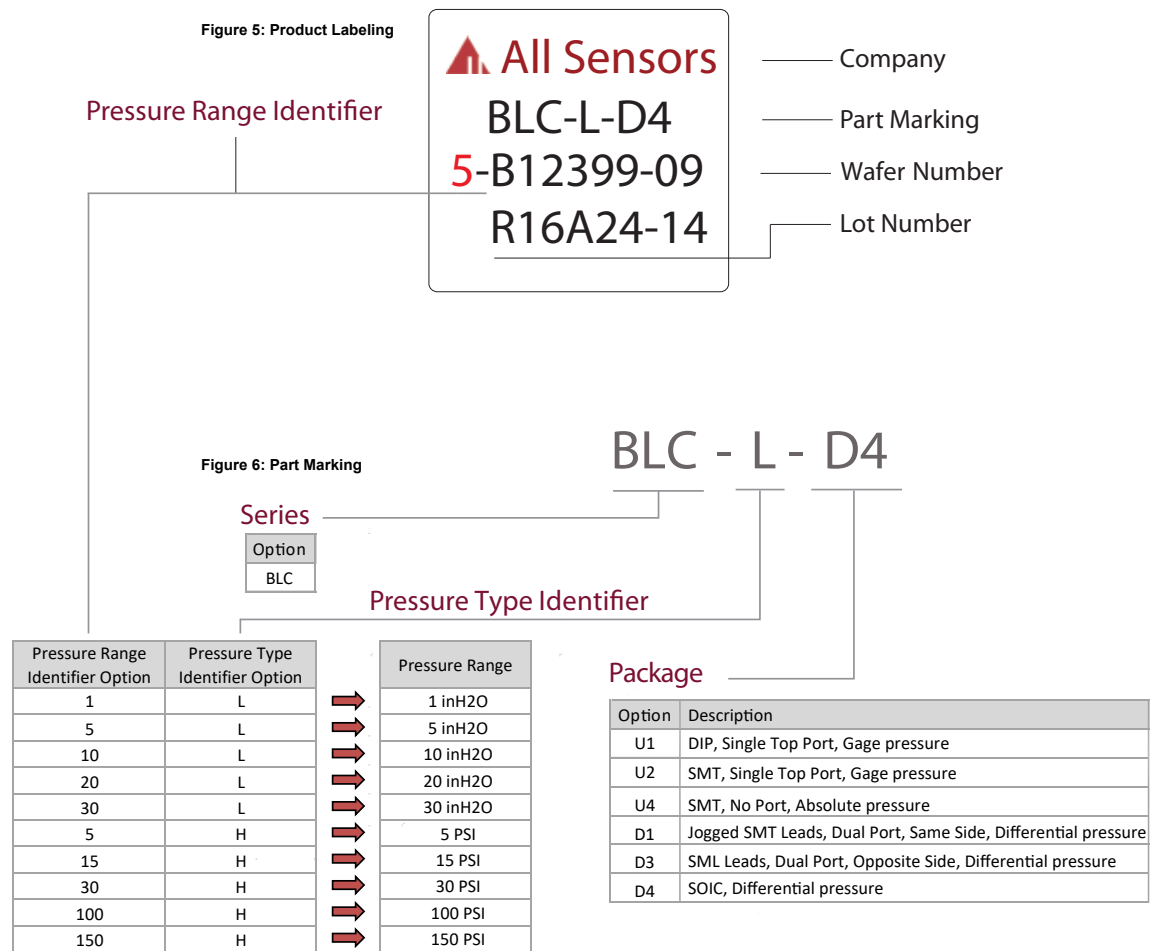

Package Drawings

U1 Package

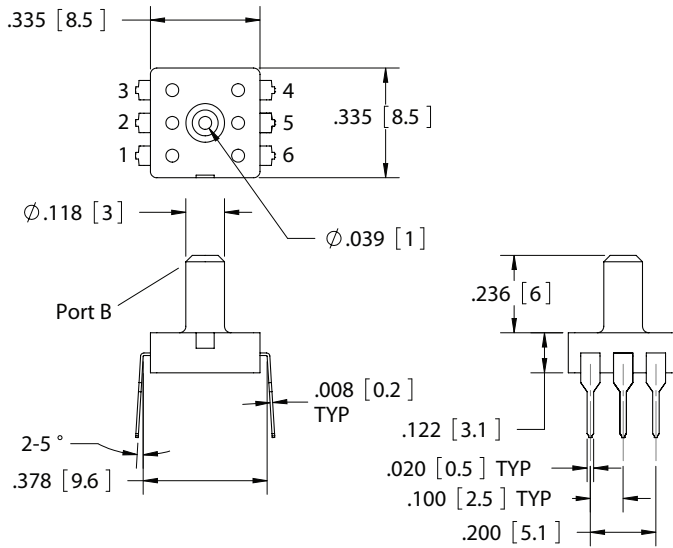

Pin	Definition
1	N/C
2	-Vout
3	-GND
4	+GND
5	+Vout
6	Vs

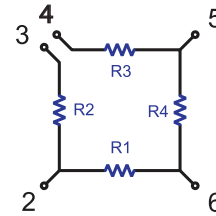

NOTES

- 1) Dimensions are in inches [mm].
- 2) For suggested pad layout, see drawing: PAD-23.
- 3) Pins 3 and 4 must be connected for Gnd.

All Sensors

TITLE: U-Series Package

SIZE FILE NAME
A U1 Package

U2 Package

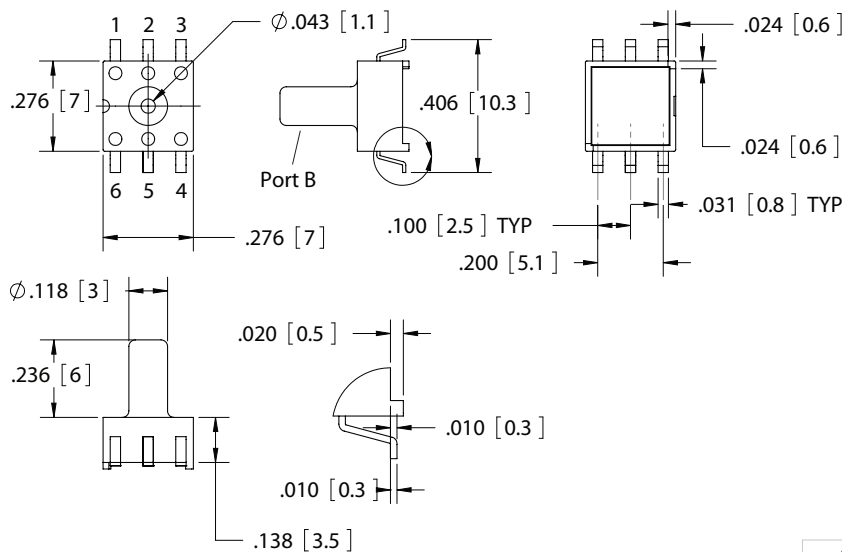

Pin	Definition
1	+GND
2	+Vout
3	Vs
4	N/C
5	-Vout
6	-GND

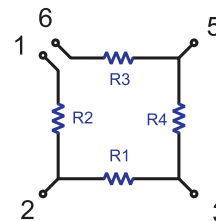

NOTES

- 1) Dimensions are in inches [mm].
- 2) For suggested pad layout, see drawing: PAD-24.
- 3) Pins 1 and 6 must be connected for Gnd.

All Sensors

TITLE: U-Series Package

SIZE FILE NAME
A U2 Package



Package Drawings (Cont'd)

U4 Package

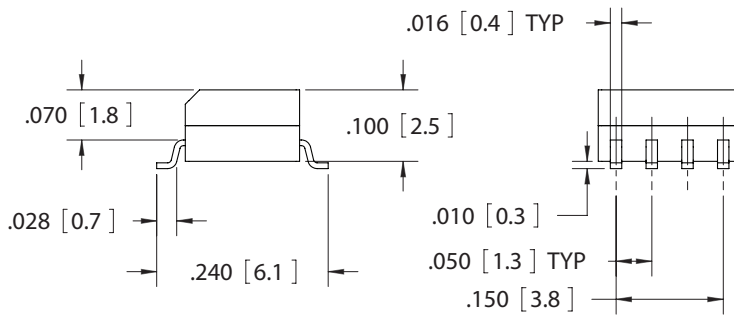
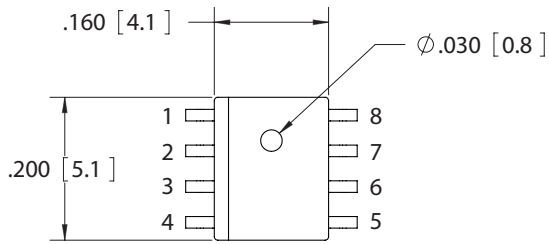

Pin	Definition
1	N/C
2	+Vout
3	N/C
4	+GND
5	-GND
6	-Vout
7	N/C
8	Vs

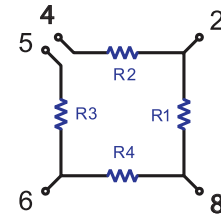

NOTES

- 1) Dimensions are in mm [inches].
- 2) Offered for absolute only.
- 3) For suggested pad layout, see drawing: PAD-26
- 4) Pins 4 and 5 must be connected for Gnd.

All Sensors

TITLE: U-Series Package

SIZE FILE NAME
A U4 Package

Package Drawings (Cont'd)

D1 Package

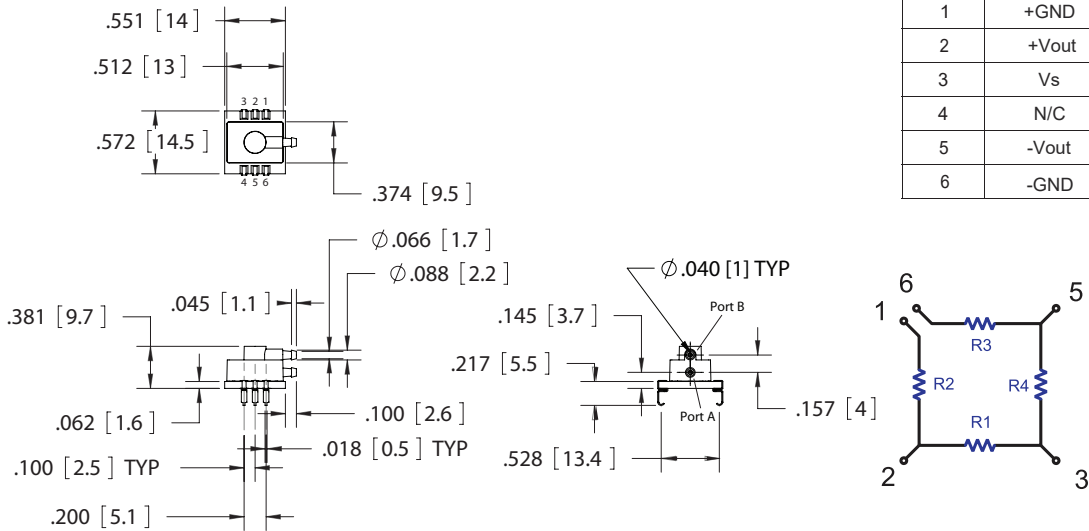

Pin	Definition
1	+GND
2	+Vout
3	Vs
4	N/C
5	-Vout
6	-GND

NOTES

- 1) Dimensions are in inches [mm].
- 2) For suggested pad layout, see drawing: PAD-20.
- 3) Pins 1 and 6 must be connected for Gnd.
- 4) Only available from 1 inH₂O to 30 inH₂O pressure ranges.

All Sensors

TITLE: D-Series Package

SIZE FILE NAME
A D1 Package

D3 Package

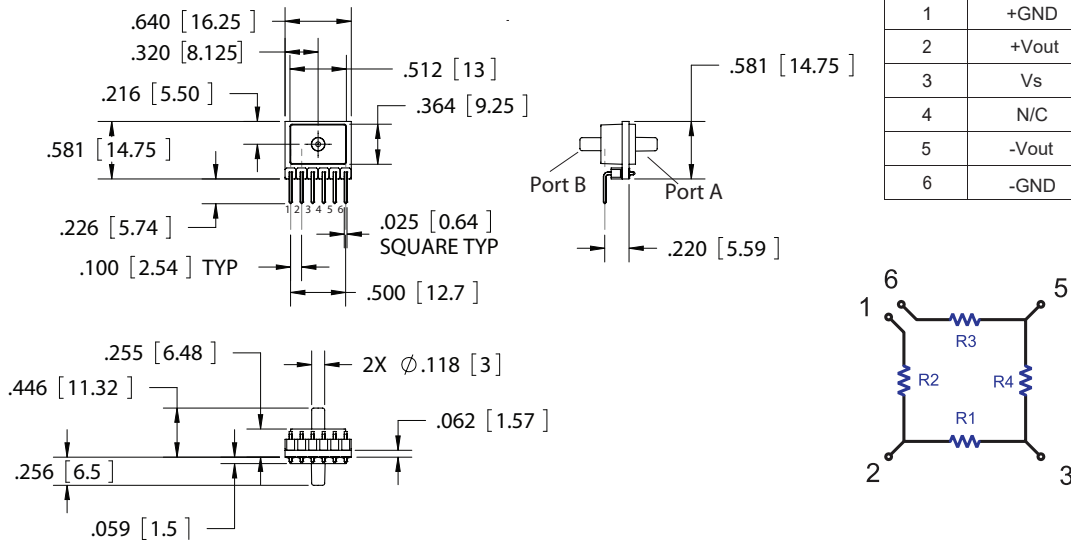

Pin	Definition
1	+GND
2	+Vout
3	Vs
4	N/C
5	-Vout
6	-GND

NOTES

- 1) Dimensions are in inches [mm].
- 2) For suggested pad layout, see drawing: PAD-21.
- 3) Pins 1 and 6 must be connected for Gnd.
- 4) Only available from 1 inH₂O to 30 inH₂O pressure ranges.

All Sensors

TITLE: D-Series Package

SIZE FILE NAME
A D3 Package



D4 Package

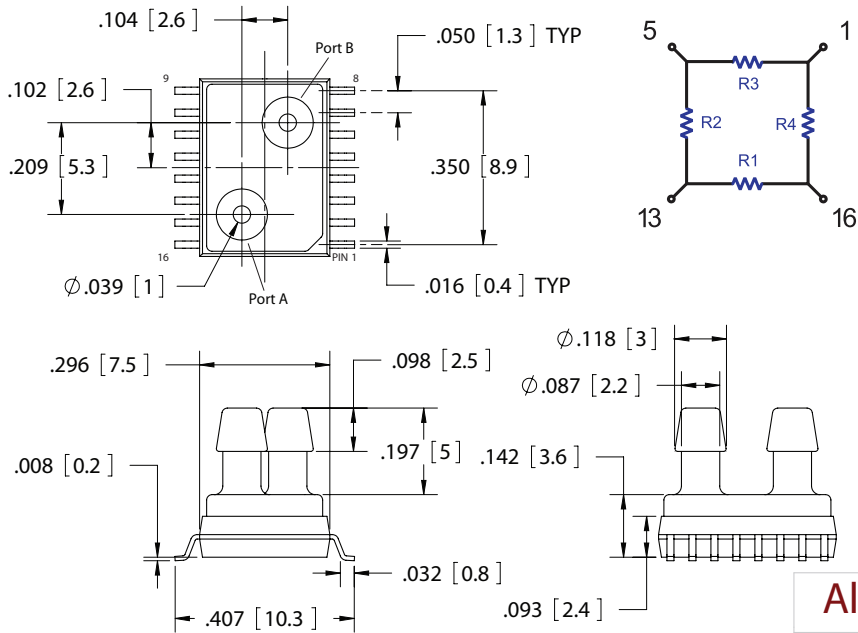

Pin	Definition
1	-Vout
2	N/C
3	N/C
4	N/C
5	GND
6	N/C
7	N/C
8	N/C
9	N/C
10	N/C
11	N/C
12	N/C
13	+Vout
14	N/C
15	N/C
16	Vs

NOTES

- 1) Dimensions are in inches [mm].
- 2) For suggested pad layout, see drawing: PAD-22.

All Sensors

TITLE: D-Series Package

SIZE FILE NAME
A D4 Package

Pressure Tubing Recommendations

Tubing Number	Part Number	Description
1	ABX00002	Versilic SPX-50, 1/16" I.D. x 1/8" O.D. x 1/32" Wall
2	ABX00004	Versilic SPX-50, 3/32" I.D. x 5/32" O.D. x 1/32" Wall

Package	Tubing Number
D1	1
D3	2
D4	2
U1	2
U2	2
U4	N/A

Packaging

TUBE



ALL PRODUCTS FOUND IN THIS DATASHEET ARE PACKAGED IN TUBES WITH PIN 1 ORIENTED TOWARDS THE WHITE STOPPER.

Notes

- 1) Contact factory for alternate packing options.



Suggested Pad Layout

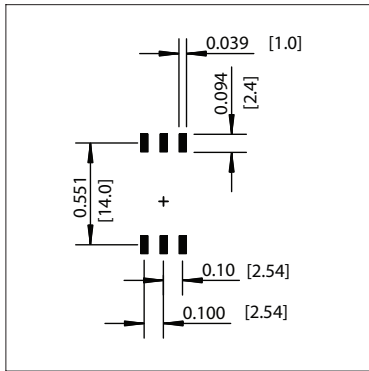

PAD-20

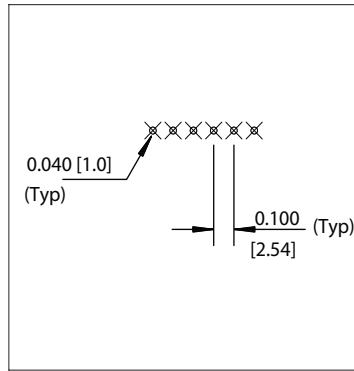

PAD-21

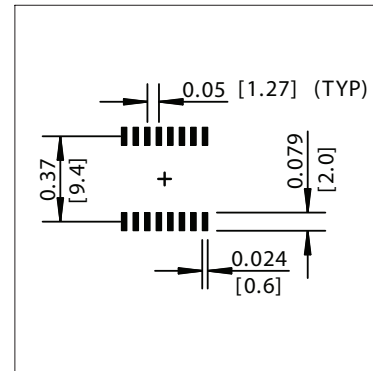

PAD-22

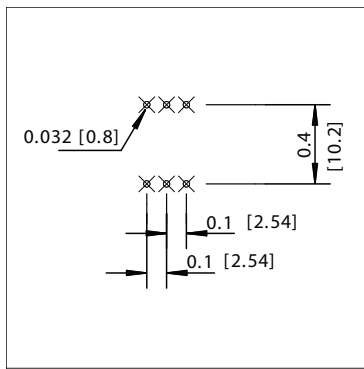

PAD-23

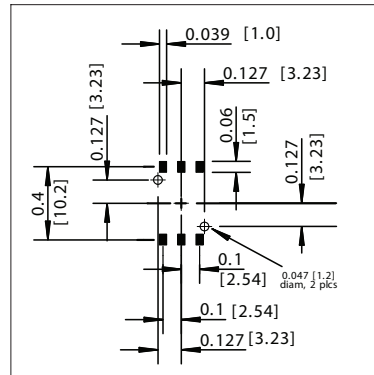

PAD-24

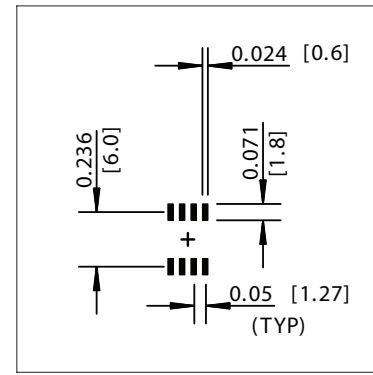

PAD-26

Dimensions are in inches [mm].

All Sensors reserves the right to make changes to any products herein. All Sensors does not assume any liability arising out of the application or use of any product or circuit described herein, neither does it convey any license under its patent rights nor the rights of others.

BLC SERIES BASIC COMPACT PRESSURE SENSORS