

REVISIONS					
REV	ECO	DESCRIPTION	DATE	BY	APPR
A3	-	RELEASE NEW DWG FORMAT	18/JUN/13	DRP	-

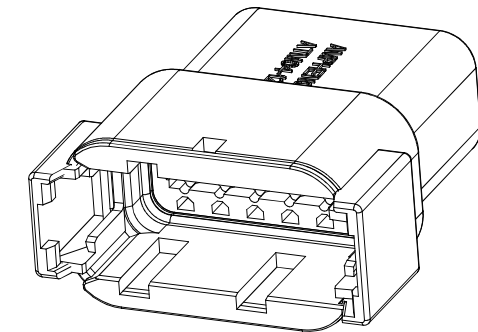

REQUIRES CONTACT RETENTION WEDGE AWM-8P

1 KEYWAY (3) PLACES

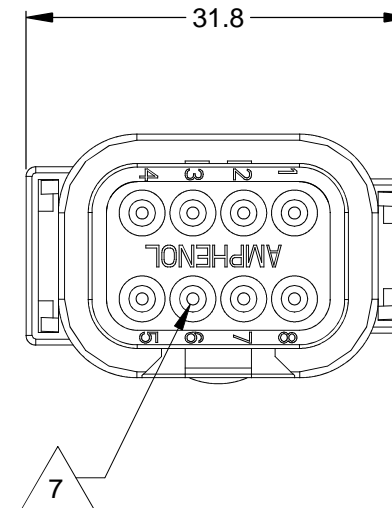
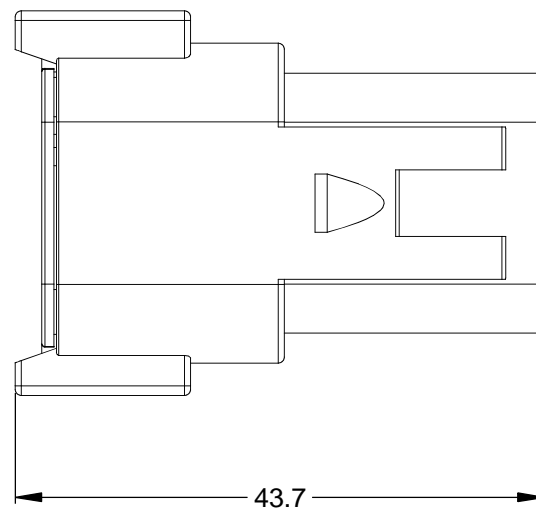
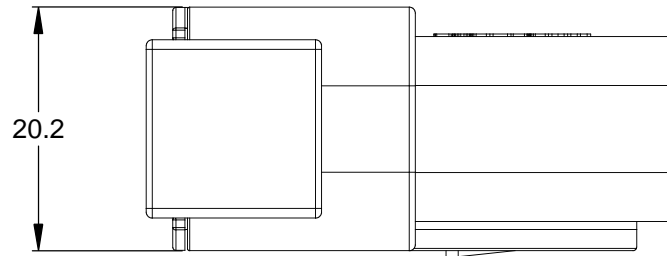
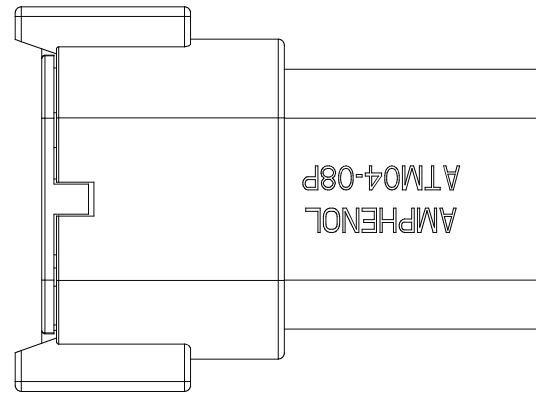
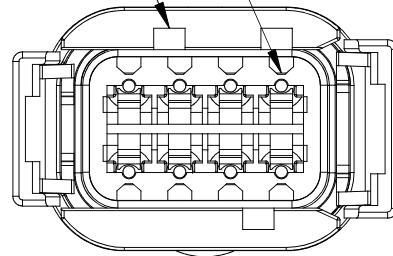

NOTES: UNLESS OTHERWISE SPECIFIED

1 SEE SHEET 2 FOR KEY ARRANGEMENTS AND COLORS.

2. MATERIAL:  
HOUSING: THERMOPLASTIC  
SEAL: SILICONE RUBBER

3. MODIFICATIONS: N/A

4. SPECIFICATIONS:  
4.1 CURRENT RATING: 7.5 AMPS  
4.2 OPERATING TEMPERATURE: -55°C TO +125°C.  
4.3 DIELECTRIC WITHSTANDING VOLTAGE: LESS THAN 2 MILLIAMPS CURRENT LEAKAGE @ 1500 VOLTS AC.  
4.4 INSULATION RESISTANCE: 1000 MEGOHMS MIN @ 25°C.  
4.5 MOISTURE RESISTANCE: IP67 ( MATED CONDITION )  
4.6 MATING CYCLE DURABILITY: 100 CYCLES  
4.7 RoHS COMPLIANT

5. MATING PART: ATM06-08SX\* PLUG.  
( X = A,B,C,D KEYS; \* = MODIFICATIONS AND COLORS )

6. ALL DIMENSIONS ARE FOR REFERENCE USE ONLY.

7 CONTACT SIZE AND REAR SEAL WIRE RANGE:

CONTACT SIZE	MIN. INSUL O.D.	MAX. INSUL O.D.	TYPICAL WIRE RANGE
20	1.35 mm (.053 in)	3.05 mm (.120 in)	16 - 22 AWG

TITLE: RECEPTACLE, KEYED, 8 PIN, ATM SERIES

DWG NO.: ATM04-08PX-XXX

REV: A3

SH: 1

OF: 2

QUANTITY	SEE SHEET 2 PART NUMBER	DESCRIPTION	ITEM
<b>MATERIALS LIST</b>			
UNLESS OTHERWISE SPECIFIED 1) All dimensions are in metric (mm). 2) Tolerances are as follows: 1 PL DEC ±0.30 2 PL DEC ±0.15 3 PL DEC ±0.08 Fractions ±1/64 Angles ±1° 3) Note reference = X		SIGNATURES DRAWN: D.PARKS CHECKED: ENGINEER: APPROVAL:	DATE 18/JUN/13
MATERIAL SPECIFICATIONS:		<p style="text-align: center;"><b>Amphenol</b></p> <p style="text-align: center;">Sine Systems - www.amphenol-sine.com 44724 Morley Drive Clinton Township, MI 48036</p> <p style="text-align: center;"><b>RECEPTACLE, KEYED, 8 PIN, ATM SERIES</b></p>	
PROCESS SPECIFICATIONS:			
NEXT ASSY:	CUSTOMER:	THIS DRAWING IS SUPPLIED FOR INFORMATION ONLY. DESIGN FEATURES, SPECIFICATIONS AND PERFORMANCE DATA SHOWN HEREON ARE THE PROPERTY OF THE AMPHENOL CORPORATION. NO RIGHTS OF REPRODUCTION ARE IMPLIED. ALL DIMENSIONS ARE SUBJECT TO NORMAL MANUFACTURING VARIATIONS.	
SCALE: NONE		SIZE: <b>B C-</b>	REVISION: <b>A3</b>
		DWG NO.: <b>ATM04-08PX-XXX</b>	SHEET <b>1</b> OF <b>2</b>

REVISIONS					
REV	ECO	DESCRIPTION	DATE	BY	APPR

P/N ATM04-08PA  
KEY-A CONFIGURATION  
STANDARD COLOR: GREY

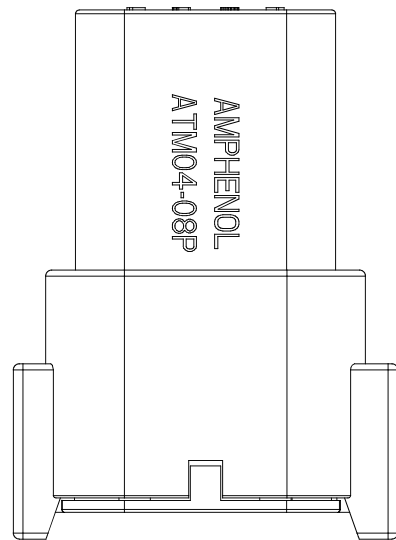

P/N ATM04-08PB  
KEY-B CONFIGURATION  
STANDARD COLOR: BLACK

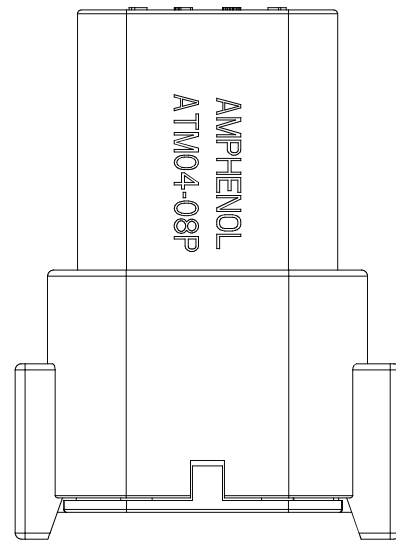

P/N ATM04-08PC  
KEY-C CONFIGURATION  
STANDARD COLOR: GREEN

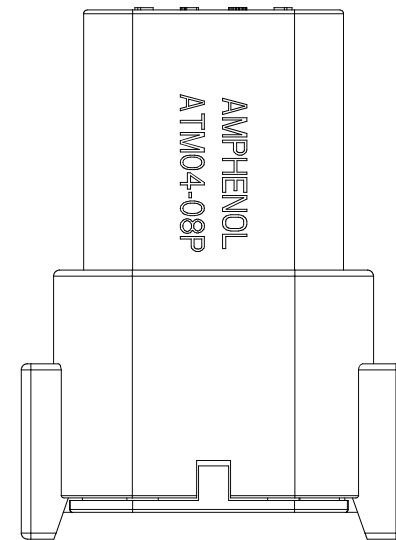

P/N ATM04-08PD  
KEY-D CONFIGURATION  
STANDARD COLOR: BROWN

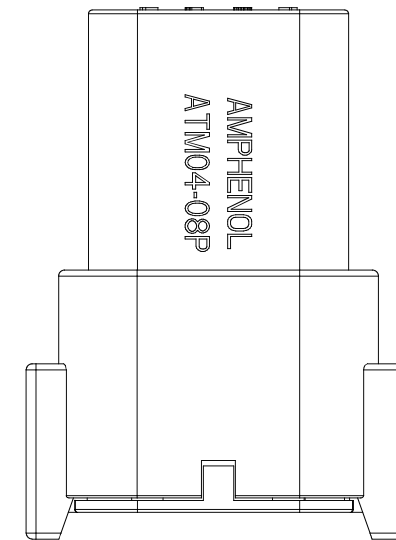

KEYWAY (3) PLACES

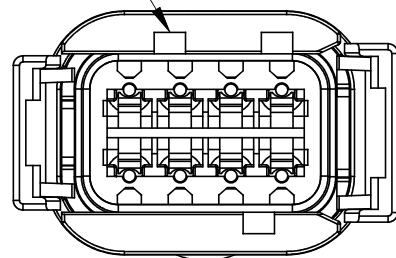

KEYWAY (3) PLACES

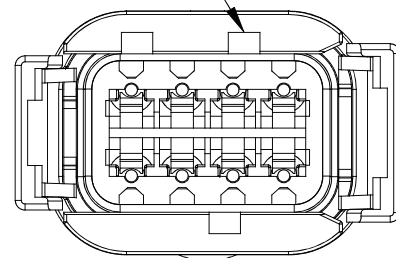

KEYWAY (3) PLACES

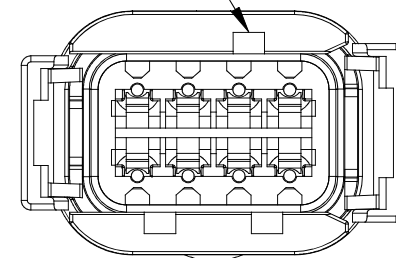

KEYWAY (3) PLACES

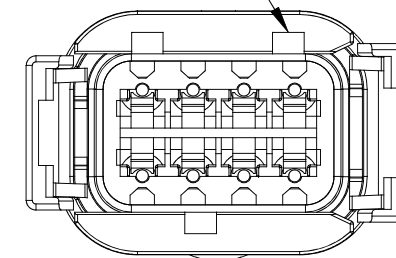

KEY-A CONFIGURATION	
COLOR	PART NUMBER
<b>* GREY</b>	<b>ATM04-08PA</b>
BLACK	ATM04-08PA-BLK
GREEN	ATM04-08PA-GRN
BROWN	ATM04-08PA-BRN

KEY-B CONFIGURATION	
COLOR	PART NUMBER
GREY	ATM04-08PB-GRY
<b>* BLACK</b>	<b>ATM04-08PB</b>
GREEN	ATM04-08PB-GRN
BROWN	ATM04-08PB-BRN

KEY-C CONFIGURATION	
COLOR	PART NUMBER
GREY	ATM04-08PC-GRY
BLACK	ATM04-08PC-BLK
<b>* GREEN</b>	<b>ATM04-08PC</b>
BROWN	ATM04-08PC-BRN

KEY-D CONFIGURATION	
COLOR	PART NUMBER
GREY	ATM04-08PD-GRY
BLACK	ATM04-08PD-BLK
GREEN	ATM04-08PD-GRN
<b>* BROWN</b>	<b>ATM04-08PD</b>

NOTE:

AN ASTERISKS ( \* ) PLACED BEFORE THE COLOR DENOTES THE STANDARD MOLDED COLOR OF THE CONNECTORS SHOWN ABOVE.

OTHER COLORS SHOWN ARE AVAILABLE VIA SPECIAL ORDER.

TITLE: RECEPTACLE, KEYED, 8 PIN, ATM SERIES  
DWG NO.: ATM04-08PX-XXX  
REV: A3  
SH: 2  
OF: 2



QUANTITY	PART NUMBER	DESCRIPTION	ITEM
<b>MATERIALS LIST</b>			
UNLESS OTHERWISE SPECIFIED		SIGNATURES DATE	
1) All dimensions are in metric (mm).		DRAWN: D.PARKS 18/JUN/13	
2) Tolerances are as follows:		CHECKED:	
1 PL DEC ±0.30		ENGINEER:	
2 PL DEC ±0.15		APPROVAL:	
3 PL DEC ±0.08		CUSTOMER:	
3) Note reference = $\triangle$ X		THIS DRAWING IS SUPPLIED FOR INFORMATION ONLY. DESIGN FEATURES, SPECIFICATIONS AND PERFORMANCE DATA SHOWN HEREON ARE THE PROPERTY OF THE AMPHENOL CORPORATION. NO RIGHTS OF REPRODUCTION ARE IMPLIED. ALL DIMENSIONS ARE SUBJECT TO NORMAL MANUFACTURING VARIATIONS.	
MATERIAL SPECIFICATIONS:		RECEPTACLE, KEYED, 8 PIN, ATM SERIES	
PROCESS SPECIFICATIONS:		SIZE: B C- DWG NO.: ATM04-08PX-XXX REVISION: A3	
NEXT ASSY:		SCALE: NONE SHEET 2 OF 2	

**Amphenol**





Sine Systems - www.amphenol-sine.com  
44724 Morley Drive  
Clinton Township, MI 48036

# ATM Series™ - Contact Size 20 Options



Machined Contacts, Sockets & Pins				
Part Number	Description	Size	AWG	Type
AT60-010-2031	Male Contact - Pin, Gold-plated	20	16-18	Machined
AT62-005-20141	Female Contact - Socket, Gold-plated	20	16-18	Machined
AT60-010-20141	Male Contact - Pin, Nickel-plated	20	16-18	Machined
AT62-005-2031	Female Contact - Socket, Nickel-plated	20	16-18	Machined
AT60-202-2031	Male Contact - Pin, Gold-plated	20	20-22	Machined
AT62-201-2031	Female Contact - Socket, Gold-plated	20	20-22	Machined
AT60-202-20141	Male Contact - Pin, Nickel-plated	20	20-22	Machined
AT62-201-20141	Female Contact - Socket, Nickel-plated	20	20-22	Machined

Tooling - Machined Contacts		
Part	Part Number	Description
	CA-5D12	Universal Hand Crimp Tool, Size 12/16/20 (Machined contacts only)
	CA-5E12	Pneumatic Crimp Tool, Size 12/16/20 (Machined contacts only)

Contact Removal Tools		
Part	Part Number	Description
	ART1-100	Used for removal of contacts for A Series™ products
	AT11-240-2005	Contact Removal Tool, Plastic, Size 20

Sealing Plugs		
Part	Part Number	Description
	AT13-204-2005	Sealing Plug, Size 20, White
	AT13-204-2005-SR	Sealing Plug, Size 20, SR01 Series, Black
	ATM13-217-2005	Locking Sealing Plug, Size 20, Grey
	ATM13-217-2005-SR	Locking Sealing Plug, Size 20, SR01 Series, Blue

Stamped & Formed Contacts, Sockets & Pins				
Part Number	Description	Size	AWG	Type
AT60-20-0144	Male Contact - Pin, Gold-plated	20	16-22	Stamped & Formed
AT62-20-0144	Female Contact - Socket, Gold-plated	20	16-22	Stamped & Formed
AT60-20-0244	Male Contact - Socket, Gold-plated	20	16-22	Stamped & Formed
AT62-20-0244	Female Contact - Socket, Gold-plated	20	16-22	Stamped & Formed
AT60-20-0122	Male Contact - Pin, Nickel-plated	20	16-22	Stamped & Formed
AT62-20-0122	Female Contact - Socket, Nickel-plated	20	16-22	Stamped & Formed
AT60-20-0222	Male Contact - Socket, Nickel-plated	20	16-22	Stamped & Formed
AT62-20-0222	Female Contact - Socket, Nickel-plated	20	16-22	Stamped & Formed
AT60-20-0277	Male Contact - Socket, Tin-plated	20	16-22	Stamped & Formed
AT62-20-0277	Female Contact - Socket, Tin-plated	20	16-22	Stamped & Formed
AT60-20-0422	Male Contact - Socket, Nickel-plated	20	20-22	Stamped & Formed
AT62-20-0444	Female Contact - Socket, Gold-plated	20	20-22	Stamped & Formed

Tooling - Stamped & Formed Contacts		
Part	Part Number	Description
	MFX-3974	Crimp Die - Size 20 (S&F contacts only)
	MFX-3976	Crimp Die - Size 20 (S&F contacts only) 20-22AWG -04XX Series
	MFX-3978	Crimp Die - Size 20 (S&F contacts only) 20-22AWG -02XX Series
	ATT-20-00	Hand Crimp Tool - Size 20, 20AWG (S&F contacts only)

**Amphenol Sine Systems**  
 44724 Morley Drive  
 Clinton Township, MI 48036 USA  
[www.amphenol-sine.com](http://www.amphenol-sine.com)  
 03/2022