

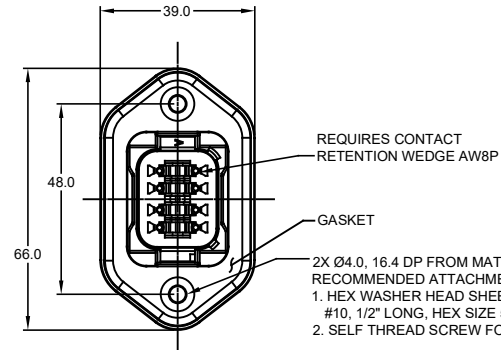

MOUNTING PLATE SIZE

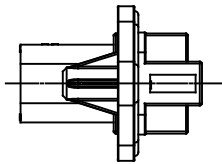

STANDARD OR REDUCED DIAMETER SEAL



| REVISIONS | | | | | |
|-----------|-----|--|---------|-------|-------|
| REV | ECO | DESCRIPTION | DATE | BY | APPR |
| A1 | - | RELEASE | 29JUN15 | JAH | |
| A2 | - | UPDATE APPEARANCE | 20APR16 | JARRY | TOMMY |
| A3 | - | ADDED -15 & -16 OPTIONS ADDED COLORS TO NOTE #1 | 23MAR18 | JAH | |

NOTES: UNLESS OTHERWISE SPECIFIED

- MATERIAL:
 - HOUSING: THERMOPLASTIC; COLOR: PER KEY OPTION
 - END CAP: THERMOPLASTIC; COLOR: BLACK
 - STRAIN RELIEF CAP: THERMOPLASTIC; COLOR: BLACK
 - SEALS: SILICONE RUBBER; COLOR: RED
- MODIFICATIONS: FLANGE, GASKET, END CAP (OPT), STRAIN RELIEF CAP (OPT), REDUCED DIAMETER SEAL (OPT).
- SPECIFICATIONS:
 - CURRENT RATING: 13 AMPS
 - OPERATING TEMPERATURE: -55°C TO +125°C
 - DIELECTRIC WITHSTANDING VOLTAGE: LESS THAN 2 MILLIAMPS CURRENT LEAKAGE @ 1500 VOLTS AC.
 - INSULATION RESISTANCE: 1000 MEGOHMS MIN @ 25°C.
 - MOISTURE RESISTANCE: IP67 (MATED CONDITION)
 - MATING CYCLE DURABILITY: 100 CYCLES
 - RoHS COMPLIANT
- MATING PART: AT06-08SX* PLUG
(X = A,B,C,D KEYS; * = MODIFICATIONS AND COLORS)
- ALL DIMENSIONS ARE FOR REFERENCE USE ONLY.

CONTACT SIZE AND REAR SEAL WIRE RANGE

REDUCED DIAMETER SEAL:

| CONTACT SIZE | MIN. INSUL O.D. | MAX. INSUL O.D. | TYPICAL WIRE RANGE |
|--------------|-------------------|-------------------|--------------------|
| 16 | 1.35 mm (.053 in) | 3.05 mm (.120 in) | 14 - 20 AWG |

STANDARD SEAL:

| CONTACT SIZE | MIN. INSUL O.D. | MAX. INSUL O.D. | TYPICAL WIRE RANGE |
|--------------|-------------------|-------------------|--------------------|
| 16 | 2.24 mm (.088 in) | 3.68 mm (.145 in) | 14 - 20 AWG |



| | | | | | | |
|---------------------------------------|--|--------------------------|--|--|--------------|------------------------|
| SEE SHEET 2 FOR KEYS | | PART NUMBER | | DESCRIPTION | | ITEM |
| MATERIALS LIST | | | | | | |
| UNLESS OTHERWISE SPECIFIED | | SIGNATURES | | DATE | | |
| 1) All dimensions are in metric (mm). | | DRAWN: J. HEAD | | 14JUL15 | | |
| 2) Tolerances are as follows: | | CHECKED: | | FRACTIONS ± 1/64 | | |
| 1 PL DEC ±0.30 | | ENGINEER: | | ANGLES ± 1° | | |
| 2 PL DEC ±0.15 | | APPROVAL: | | | | |
| 3 PL DEC ±0.08 | | CUSTOMER: | | | | |
| 3) Note reference = | | MATERIAL SPECIFICATIONS: | | THIS DRAWING IS SUPPLIED FOR INFORMATION ONLY. DESIGN FEATURES, SPECIFICATIONS AND PERFORMANCE DATA SHOWN HEREON ARE THE PROPERTY OF THE AMPHENOL CORPORATION. NO RIGHTS OF REPRODUCTION ARE IMPLIED. ALL DIMENSIONS ARE SUBJECT TO NORMAL MANUFACTURING VARIATIONS. | | |
| PROCESS SPECIFICATIONS: | | NEXT ASSY: | | SIZE: B | TYPE: C- | DWG NO: AT04-08PX-PMXX |
| | | | | SCALE: NONE | REVISION: A3 | |
| | | | | SINE SYSTEMS - www.amphenol-sine.com 44724 Morley Drive Clinton Township, MI 48036 | | |
| | | | | RECEPTACLE, 8 PIN, AT SERIES, W/FLANGE | | |
| | | | | SHEET 1 OF 2 | | |

TITLE: RECEPTACLE, 8 PIN, AT SERIES, W/FLANGE
DWG NO: AT04-08PX-PMXX
REV: A3
SHEET 1 OF 2

| REVISIONS | | | | | |
|-----------|-----|--|---------|-------|-------|
| REV | ECO | DESCRIPTION | DATE | BY | APPR |
| A1 | - | RELEASE | 14JUL15 | JAH | |
| A2 | - | UPDATE APPEARANCE | 20APR16 | JARRY | TOMMY |
| A3 | - | ADDED -15 & -16 OPTIONS ADDED COLORS TO NOTE #1 | 23MAR18 | JAH | |

P/N AT04-08PA-PMXX
KEY-A CONFIGURATION
STANDARD HOUSING COLOR: GREY



| KEY-A CONFIGURATION | | | |
|---------------------|--------------|---------|---------------|
| PART NUMBER | SEAL | END CAP | STRAIN RELIEF |
| AT04-08PA-PM11 | STANDARD | NO | NO |
| AT04-08PA-PM12 | REDUCED DIA. | NO | NO |
| AT04-08PA-PM13 | STANDARD | YES | NO |
| AT04-08PA-PM14 | REDUCED DIA. | YES | NO |
| AT04-08PA-PM15 | STANDARD | NO | YES |
| AT04-08PA-PM16 | REDUCED DIA. | NO | YES |

P/N AT04-08PB-PMXX
KEY-B CONFIGURATION
STANDARD HOUSING COLOR: BLACK

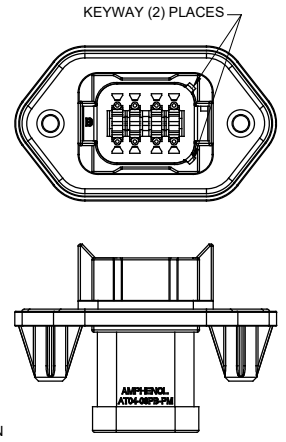

| KEY-B CONFIGURATION | | | |
|---------------------|--------------|---------|---------------|
| PART NUMBER | SEAL | END CAP | STRAIN RELIEF |
| AT04-08PB-PM11 | STANDARD | NO | NO |
| AT04-08PB-PM12 | REDUCED DIA. | NO | NO |
| AT04-08PB-PM13 | STANDARD | YES | NO |
| AT04-08PB-PM14 | REDUCED DIA. | YES | NO |
| AT04-08PB-PM15 | STANDARD | NO | YES |
| AT04-08PB-PM16 | REDUCED DIA. | NO | YES |

P/N AT04-08PC-PMXX
KEY-C CONFIGURATION
STANDARD HOUSING COLOR: GREEN

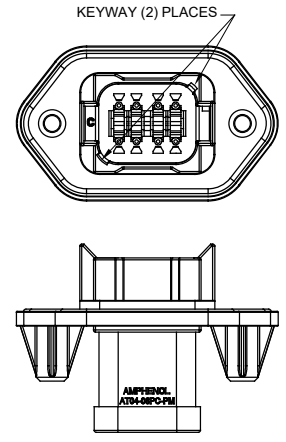

| KEY-C CONFIGURATION | | | |
|---------------------|--------------|---------|---------------|
| PART NUMBER | SEAL | END CAP | STRAIN RELIEF |
| AT04-08PC-PM11 | STANDARD | NO | NO |
| AT04-08PC-PM12 | REDUCED DIA. | NO | NO |
| AT04-08PC-PM13 | STANDARD | YES | NO |
| AT04-08PC-PM14 | REDUCED DIA. | YES | NO |
| AT04-08PC-PM15 | STANDARD | NO | YES |
| AT04-08PC-PM16 | REDUCED DIA. | NO | YES |

P/N AT04-08PD-PMXX
KEY-D CONFIGURATION
STANDARD HOUSING COLOR: BROWN

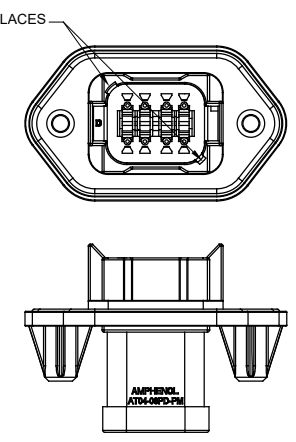

| KEY-D CONFIGURATION | | | |
|---------------------|--------------|---------|---------------|
| PART NUMBER | SEAL | END CAP | STRAIN RELIEF |
| AT04-08PD-PM11 | STANDARD | NO | NO |
| AT04-08PD-PM12 | REDUCED DIA. | NO | NO |
| AT04-08PD-PM13 | STANDARD | YES | NO |
| AT04-08PD-PM14 | REDUCED DIA. | YES | NO |
| AT04-08PD-PM15 | STANDARD | NO | YES |
| AT04-08PD-PM16 | REDUCED DIA. | NO | YES |

| QUANTITY | PART NUMBER | DESCRIPTION | ITEM |
|---|---|---|---|
| MATERIALS LIST | | | |
| <small>UNLESS OTHERWISE SPECIFIED</small> 1) All dimensions are in metric (mm). 2) Tolerances are as follows: 1 PL DEC ±0.30 Fractions ±1/64 2 PL DEC ±0.15 Angles ±1° 3 PL DEC ±0.08 3) Note reference = | | SIGNATURES DATE DRAWN: J.HEAD 14JUL15 CHECKED: ENGINEER: APPROVAL: CUSTOMER: | Sine Systems - www.amphenol-sine.com 44724 Morley Drive Clinton Township, MI 48036 RECEPTACLE, 8 PIN, AT SERIES, W/FLANGE |
| MATERIAL SPECIFICATIONS: PROCESS SPECIFICATIONS: NEXT ASSY: | <small>THIS DRAWING IS SUPPLIED FOR INFORMATION ONLY. DESIGN FEATURES, SPECIFICATIONS AND PERFORMANCE DATA SHOWN HEREON ARE THE PROPERTY OF THE AMPHENOL CORPORATION. NO RIGHTS OF REPRODUCTION ARE IMPLIED. ALL DIMENSIONS ARE SUBJECT TO NORMAL MANUFACTURING VARIATIONS.</small> | SIZE: B C- TYPE: AT04-08PX-PMXX DWG NO: A3 SCALE: NONE SHEET 2 OF 2 | |

TITLE: RECEPTACLE, 8 PIN, AT SERIES, W/FLANGE
 DWG NO: AT04-08PX-PMXX
 REV: A3
 SH: 2
 OF: 2



AT Series™ - Contact Size 16 Options

| Machined Contacts, Sockets & Pins | | | | |
|-----------------------------------|--|------|-------|----------|
| Part Number | Description | Size | AWG | Type |
| AT60-215-1631 | Male Contact - Pin, Gold-plated | 16 | 14 | Machined |
| AT62-209-1631 | Female Contact - Socket, Gold-plated | 16 | 14 | Machined |
| AT60-215-16141 | Male Contact - Pin, Nickel-plated | 16 | 14 | Machined |
| AT62-209-16141 | Female Contact - Socket, Nickel-plated | 16 | 14 | Machined |
| AT60-202-1631 | Male Contact - Pin, Gold-plated | 16 | 16-20 | Machined |
| AT62-201-1631 | Female Contact - Socket, Gold-plated | 16 | 16-20 | Machined |
| AT60-202-16141 | Male Contact - Pin, Nickel-plated | 16 | 16-20 | Machined |
| AT62-201-16141 | Female Contact - Socket, Nickel-plated | 16 | 16-20 | Machined |
| AT60-202-1631-22 | Male Contact - Pin, Gold-plated | 16 | 22-24 | Machined |
| AT62-201-1631-22 | Female Contact - Socket, Gold-plated | 16 | 22-24 | Machined |
| AT60-202-16141-22 | Male Contact - Pin, Nickel-plated | 16 | 22-24 | Machined |
| AT62-201-16141-22 | Female Contact - Socket, Nickel-plated | 16 | 22-24 | Machined |

| Tooling - Machined Contacts | | |
|---|-------------|---|
| Part | Part Number | Description |
|  | CA-5D12 | Universal Hand Crimp Tool, Size 12/16/20 (Machined contacts only) |
|  | CA-5E12 | Pneumatic Crimp Tool, Size 12/16/20 (Machined contacts only) |

| Contact Removal Tools | | |
|---|---------------|---|
| Part | Part Number | Description |
|  | ATRT-100 | Used for removal of contacts for A Series™ products |
|  | AT11-310-1605 | Contact Removal Tool, Plastic, Size 16 |
|  | A114017 | Sealing Plug, Size 16, White |

| Stamped & Formed Contacts, Sockets & Pins | | | | |
|---|--|------|-------|------------------|
| Part Number | Description | Size | AWG | Type |
| AT60-14-0144 | Male Contact - Pin, Gold-plated | 16 | 14-16 | Stamped & Formed |
| AT62-14-0144 | Female Contact - Socket, Gold-plated | 16 | 14-16 | Stamped & Formed |
| AT60-14-0122 | Male Contact - Pin, Nickel-plated | 16 | 14-16 | Stamped & Formed |
| AT62-14-0122 | Female Contact - Socket, Nickel-plated | 16 | 14-16 | Stamped & Formed |
| AT60-16-0144 | Male Contact - Pin, Gold-plated | 16 | 16-18 | Stamped & Formed |
| AT62-16-0144 | Female Contact - Socket, Gold-plated | 16 | 16-18 | Stamped & Formed |
| AT60-16-0122 | Male Contact - Pin, Nickel-plated | 16 | 16-18 | Stamped & Formed |
| AT62-16-0122 | Female Contact - Socket, Nickel-plated | 16 | 16-18 | Stamped & Formed |
| AT60-16-0644 | Male Contact - Pin, Gold-plated | 16 | 18-20 | Stamped & Formed |
| AT62-16-0644 | Female Contact - Socket, Gold-plated | 16 | 18-20 | Stamped & Formed |
| AT60-16-0622 | Male Contact - Pin, Nickel-plated | 16 | 18-20 | Stamped & Formed |
| AT62-16-0622 | Female Contact - Socket, Nickel-plated | 16 | 18-20 | Stamped & Formed |
| AT60-16-0844 | Male Contact - Pin, Gold-plated | 16 | 20-22 | Stamped & Formed |
| AT62-16-0844 | Female Contact - Socket, Gold-plated | 16 | 20-22 | Stamped & Formed |
| AT60-16-0822 | Male Contact - Pin, Nickel-plated | 16 | 20-22 | Stamped & Formed |
| AT62-16-0822 | Female Contact - Socket, Nickel-plated | 16 | 20-22 | Stamped & Formed |

| Tooling - Stamped & Formed Contacts | | |
|---|-------------|---|
| Part | Part Number | Description |
|  | MFX-3950 | Crimp Die - Size 16, 18-20AWG (S&F contacts only) |
| | MFX-3953 | Crimp Die - Size 16, 16-18AWG (S&F contacts only) |
| | MFX-3975 | Crimp Die - Size 16, 14-16AWG (S&F contacts only) |
| | MFX-3990 | Crimp Die - Size 16, 20-22AWG (S&F contacts only) |
|  | ATT-16-00 | Hand Crimp Tool - Size 16, 14-16AWG (S&F contacts only) |
| | ATT-16-01 | Hand Crimp Tool - Size 16, 18-20AWG (S&F contacts only) |
| | ATT-1612-03 | Hand Crimp Tool - Size 16, 20-22AWG (S&F contacts only) |

Amphenol Sine Systems
 44724 Morley Drive
 Clinton Township, MI 48036 USA
www.amphenol-sine.com
 09/2021