

Speed Controller with One-touch Fitting Elbow Type/Universal Type

AS Series

RoHS

Minimizes installation time and cost

Reduces the mounting height and enables compact machinery design. Effective area is larger than the former model.

Tube swivels 360°

Universal type permits 360° piping swivel.

ø2 size added to applicable tubing sizes

- **Metric size** (Release button: White color)
ø2, ø3.2, ø4, ø6, ø8, ø10, ø12

- **Inch size** (Release button: Orange color)
ø1/8", ø5/32", ø3/16", ø1/4", ø5/16", ø3/8", ø1/2"

Maximum operating pressure 1 MPa max.

Applicable tubing materials

Nylon, soft nylon, and polyurethane tubing are applicable.

Retainer prevents accidental loss of needle.

Option

Nickel plated option

Model

Elbow type	Universal type	Port size	Applicable tubing O.D.															
			Metric size						Inch size									
			2	3.2	4	6	8	10	12	1/8"	3/16"	1/4"	5/16"	3/8"	1/2"			
AS12□1F-M3	AS13□1F-M3	M3 x 0.5	⊙ ⁽¹⁾	⊙ ⁽¹⁾	⊙ ⁽¹⁾							⊙ ⁽¹⁾	⊙ ⁽¹⁾	⊙ ⁽¹⁾				
AS12□1F-M5	AS13□1F-M5	M5 x 0.8	⊙ ⁽¹⁾	⊙ ⁽¹⁾	⊙ ⁽¹⁾							⊙ ⁽¹⁾	⊙ ⁽¹⁾	⊙ ⁽¹⁾				
AS12□1F-U10/32	AS13□1F-U10/32	10-32UNF		⊙ ⁽¹⁾	⊙ ⁽¹⁾							⊙ ⁽¹⁾	⊙ ⁽¹⁾	⊙ ⁽¹⁾				
AS22□1F-01	AS23□1F-01	R1/8		⊙ ⁽¹⁾	⊙ ⁽¹⁾							⊙ ⁽¹⁾	⊙ ⁽¹⁾	⊙ ⁽¹⁾				
AS22□1F-02	AS23□1F-02	R1/4			⊙ ⁽¹⁾	⊙ ⁽¹⁾						⊙ ⁽¹⁾	⊙ ⁽¹⁾	⊙ ⁽¹⁾			⊙ ⁽¹⁾	⊙ ⁽¹⁾
AS32□1F-02	AS33□1F-02	R1/4				⊙ ⁽¹⁾	⊙ ⁽¹⁾	⊙ ⁽¹⁾	⊙ ⁽¹⁾					⊙ ⁽¹⁾	⊙ ⁽¹⁾		⊙ ⁽¹⁾	⊙ ⁽¹⁾
AS32□1F-03	AS33□1F-03	R3/8					⊙ ⁽¹⁾	⊙ ⁽¹⁾	⊙ ⁽¹⁾								⊙ ⁽¹⁾	⊙ ⁽¹⁾
AS42□1F-04	AS43□1F-04	R1/2										●	●				●	●

Note 1) AS12□1F-M5-02 applicable cylinder bore sizes are 2.5, 4, 6.

Note 2) Elbow type only

Note 3) Meter-out and meter-in types can be visually differentiated by the lock nut. The lock nut on the meter-out type is zinc chromated (the round lock nut is electroless nickel plated), while the meter-in type is black zinc chromate plated.

Note 4) ⊙: Brass parts are electroless nickel plated, provided as standard. (N specifications)

Note 5) The elbow type is electroless nickel plated as standard. (N specifications)

Specifications

Fluid	Air
Proof pressure	1.5 MPa (1.05 MPa ⁽¹⁾)
Max. operating pressure	1 MPa (0.7 MPa ⁽¹⁾)
Mini. operating pressure	0.1 MPa
Ambient and fluid temperature	-5 to 60°C (No freezing)
Applicable tubing material ⁽²⁾	Nylon, Soft nylon, Polyurethane ⁽³⁾
Option	With seal ⁽⁴⁾ , Round lock nut ⁽⁵⁾ , Electroless nickel plated

Note 1) In case of AS12□1F-M3-02, AS12□1F-M5-02

Note 2) Use caution regarding the max. operating pressure when soft nylon or polyurethane tubing is used.

(Refer to pages 464 and 465 for details.)

Note 3) In case of AS12□1F-M3-02 and AS12□1F-M5-02, polyurethane only.

Note 4) M3, M5, 10-32UNF type ports are not available with seals.

Note 5) Brass parts are all electroless nickel plated.

Flow Rate and Sonic Conductance

Model	Metric size	AS12□1F-M3	AS12□1F-M5	AS13□1F-M3	AS13□1F-M5	AS22□1F-01	AS22□1F-02	AS23□1F-01	AS23□1F-02	AS32□1F	AS33□1F	AS42□1F	AS43□1F
		AS12□1F-M3-02	AS12□1F-M5-02	AS13□1F-M3-02	AS13□1F-M5-02	AS23□1F-01	AS23□1F-02	AS23□1F-02	AS23□1F-02	AS33□1F	AS33□1F	AS43□1F	AS43□1F
Tubing O.D.	ø2, ø3.2, ø4	ø2, ø3.2, ø4	ø3.2, ø4, ø6	ø3.2, ø4, ø6	ø3.2, ø4, ø6	ø4, ø6, ø8, ø10, ø14	ø6	ø8, ø10	ø6	ø8	ø10, ø12	ø10	ø12
	Inch size	ø1/8", ø5/32"	ø1/8", ø3/16", ø1/4", ø5/32"	ø1/8", ø3/16", ø1/4", ø5/32"	ø1/8", ø3/16", ø1/4", ø5/16"	ø5/32", ø3/16"	ø1/4", ø5/16", ø3/8"	ø1/4"	ø5/16"	ø3/8"	ø3/8"	ø3/8"	ø1/2"
Controlled flow	Flow rate L/min (NPR)	20	100	180	230	260	390	460	660	790	920	1580	1710
	Sonic conductance dm ³ /l/s/bar	0.06	0.28	0.5	0.64	0.72	1.1	1.3	1.8	2.2	2.6	4.4	4.8
Critical pressure ratio	Controlled flow	0.2	0.2		0.25			0.3			0.25		0.25
	Free flow	0.4	0.4		0.2			0.3			0.2		0.3

Note 1) Flow rate values are measured at 0.5 MPa and 20°C.

Note 2) U10/32 has the same specification as M5.

Elbow type

Applicable tubing O.D. ø2



Universal type



Symbol



Flow Direction Symbols on Body

	Meter-out type	Meter-in type
Indication symbol		
Symbol		

⚠ Caution

Be sure to read this before handling the products.
Refer to back page 50 for Safety Instructions and pages 543 to 546 for Flow Control Equipment Precautions.

Made to Order
(Refer to page 582 for details.)

How to Order

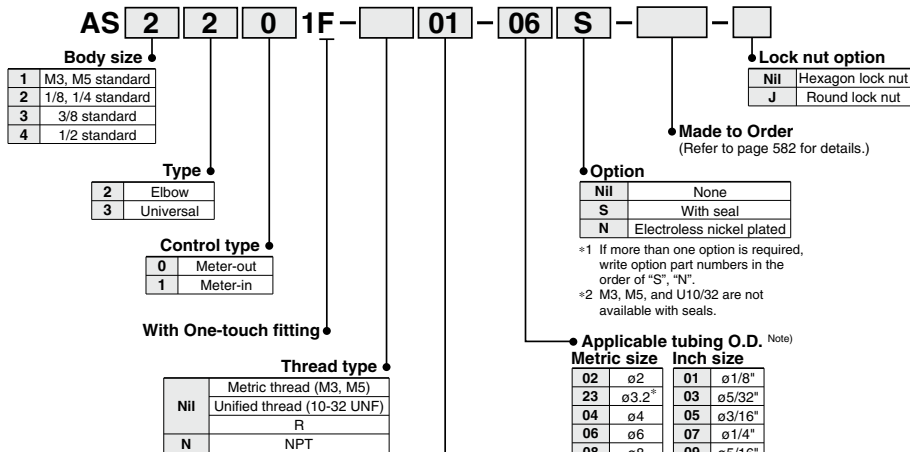

Made to Order
(For details, refer to page 582.)

Symbol	Specifications
-X12	Lubricant: Vaseline
-X21	Grease-free (Seal: Fluorine-coated) + Throttle valve (Without check valve)
-X214	Throttle valve (Without check valve)
-X250	Fixed throttle (No needle function)

Port size

M3	M3 x 0.5
M5	M5 x 0.8
U10/32	10-32 UNF
01	1/8
02	1/4
03	3/8
04	1/2

Note) For applicable tubing O.D. selection, refer to the Model on page 576.

*Use ø1/8" tube.

Needle Valve/Flow Rate Characteristics

Note) The flow rate characteristics are representative values.

AS1201F-M3, AS1211F-M3
AS1301F-M3, AS1311F-M3
AS1201F-M5-02, AS1211F-M5-02

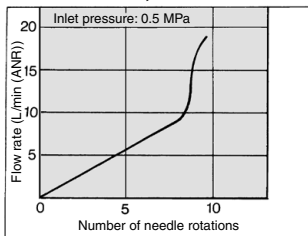

AS1201F-M5, AS1211F-M5
AS1301F-M5, AS1311F-M5

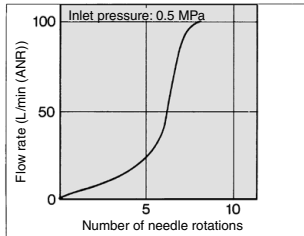

AS2201F-01, AS2211F-01
AS2301F-01, AS2311F-01

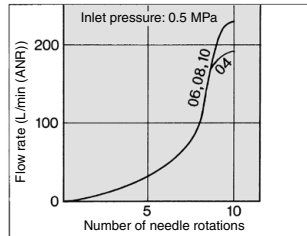

Note) *U10/32" is the same as "M5".

AS2201F-02, AS2211F-02
AS2301F-02, AS2311F-02

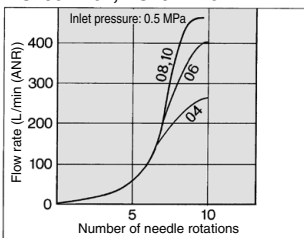

AS3201F, AS3211F
AS3301F, AS3311F

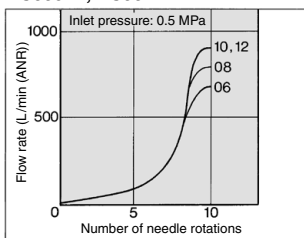

AS4201F, AS4211F
AS4301F, AS4311F

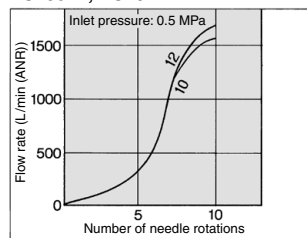

AS-F

TMH

ASD

AS

AS-FE

KE

AS-FG

AS-FP

AS-FM

AS-D

AS-T

ASP

ASN

AQ

ASV

AK

VCHC

ASR

ASQ

AS Series

Construction

Elbow type Meter-out type

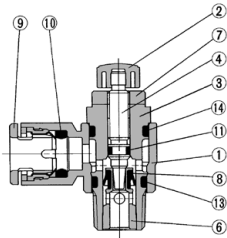

M3 port M5 port U10/32 port

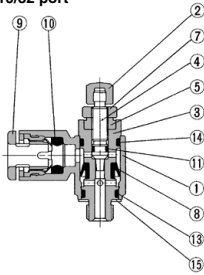

ø2 tubing type

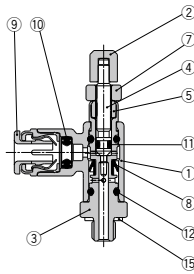

Meter-in type

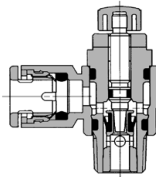

M3 port M5 port U10/32 port

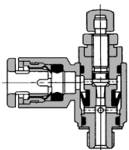

ø2 tubing type

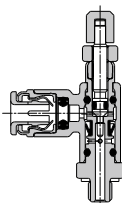

Universal type Meter-out type

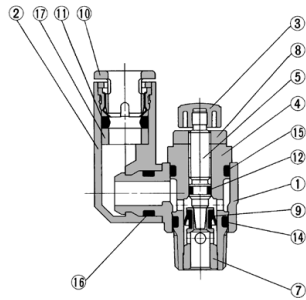

M3 port M5 port U10/32 port

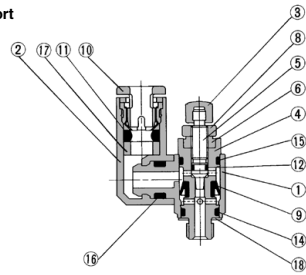

Meter-in type

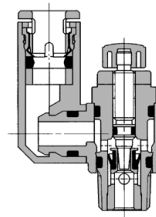

M3 port M5 port U10/32 port

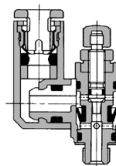

Construction

Elbow type

Meter-out type AS3201F-02

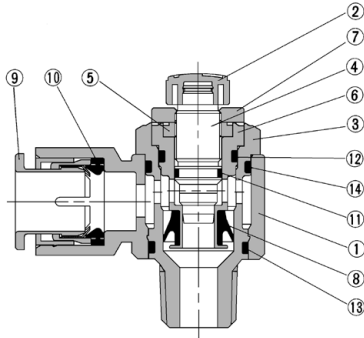

Meter-in type AS3211F-02

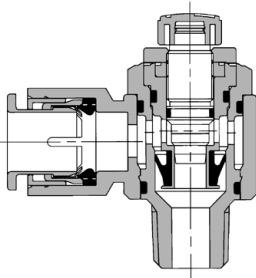

Universal type

Meter-out type AS3301F-02

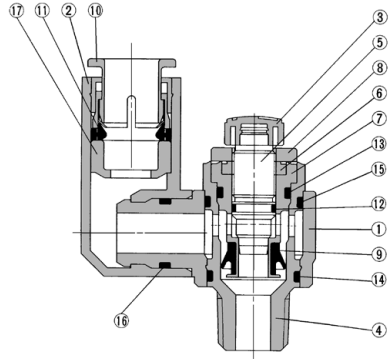

Meter-in type AS3311F-02

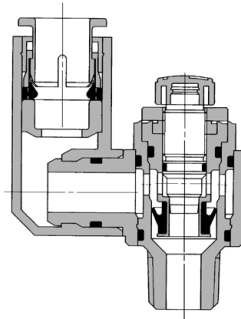

Component Parts

No.	Description	Material	Note
1	Body A	PBT	
2	Handle	PBT ⁽¹⁾	
3	Body B	Brass ⁽²⁾	Electroless nickel plated
4	Needle	Brass	Electroless nickel plated
5	Needle guide	Brass	Electroless nickel plated
6	Seat ring	Brass	⁽³⁾
7	Lock nut	Steel ⁽⁴⁾	Meter-out Zinc chromate plated ^{Note 5)} Meter-in Black zinc chromate plated
8	U-packing	HNBR	
9	Cassette	—	
10	Seal	NBR	
11	O-ring	NBR	
12	O-ring	NBR	
13	O-ring	NBR	
14	O-ring	NBR	
15	Gasket	NBR, Stainless steel	

Note 1) AS12□1F-M3 and AS12□1F-M5-02 are made of electroless nickel plated brass.

Note 2) AS12□1F-M3 is made of stainless steel.

Note 3) AS22□1F, AS32□1F: Electroless nickel plated.

* Excluding applicable tubing O.D. 3/8"

Note 4) The material of the lock nut option-J (round type) is brass.

However, note that only the AS22□1F uses steel.

Note 5) The surface treatment of the lock nut option-J (round type) is electroless nickel plating.

Component Parts

No.	Description	Material	Note
1	Body A	PBT	
2	Elbow body	PBT	
3	Handle	PBT ⁽¹⁾	
4	Body B	Brass ⁽²⁾	Electroless nickel plated
5	Needle	Brass	Electroless nickel plated
6	Needle guide	Brass	Electroless nickel plated
7	Seat ring	Brass	⁽³⁾
8	Lock nut	Steel ⁽⁴⁾	Meter-out Zinc chromate plated ^{Note 5)} Meter-in Black zinc chromate plated
9	U seal	HNBR	
10	Cassette	—	
11	Seal	NBR	
12	O-ring	NBR	
13	O-ring	NBR	
14	O-ring	NBR	
15	O-ring	NBR	
16	O-ring	NBR	
17	Spacer	—	
18	Gasket	NBR, Stainless steel	

Note 1) AS13□1F-M3 is made of electroless nickel plated brass.

Note 2) AS13□1F-M3 is made of stainless steel.

Note 3) AS23□1F, AS33□1F: Electroless nickel plated.

* Excluding applicable tubing O.D. 3/8"

Note 4) The material of the lock nut option-J (round type) is brass.

However, note that only the AS23□1F uses steel.

Note 5) The surface treatment of the lock nut option-J (round type) is electroless nickel plating.

AS-F

TMH

ASD

AS

AS-FE

KE

AS-FG

AS-FP

AS-FM

AS-D

AS-T

ASP

ASN

AQ

ASV

AK

VCHC

ASR

ASQ

AS Series



Elbow Type

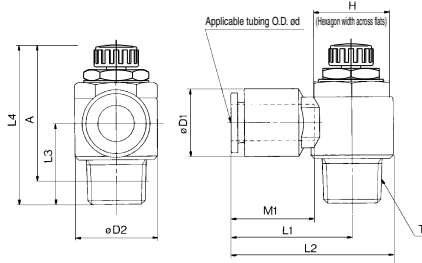

M3 port M5 port U10/32 port

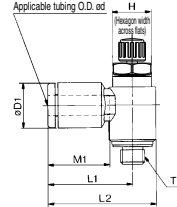
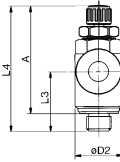

ø2 tubing type AS12□1F-M3-02 AS12□1F-M5-02

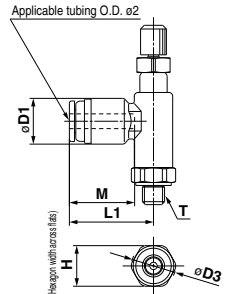
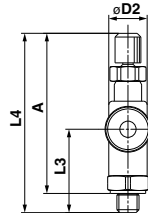

Metric Size

Model	Applicable tubing O.D. (øE)	T	H (1)	D1	D2	L3	L1	L2	L4 (3)	A (2)		M1	Weight (g)		
										Max.	Min.				
AS12□1F-M3-02	M3 x 0.5	5.5	6	5.2	6	—	—	—	11	26.8	24.3	24.3	21.8	2.4	
AS12□1F-M5-02	M5 x 0.8	7	6	5.2	7.5	11.4	—	—	11.5	27.3	24.8	24.3	21.8	3	
AS12□1F-M3-23	M3 x 0.5	3.2	—	—	—	16.1	19.7	10	10.5	26.6	24.1	24	21.5	12.7	
AS12□1F-M3-04	M3 x 0.5	4	—	—	—	—	—	—	10.5	26.6	24.1	24	21.5	12.7	
AS12□1F-M5-23	M5 x 0.8	3.2	—	—	—	17.3	22.1	—	12.3	—	—	—	—	—	
AS12□1F-U10-32-23	10-32UNF	4	—	—	—	—	—	—	12.3	—	—	—	—	—	
AS12□1F-M5-04	M5 x 0.8	4	—	—	—	17.3	22.1	—	28.6	25.8	25	22.2	—	—	
AS12□1F-U10-32-04	10-32UNF	4	—	—	—	—	—	—	28.6	25.8	25	22.2	—	—	
AS12□1F-M5-06	M5 x 0.8	6	—	—	—	18.1	22.9	11.7	—	—	—	—	13.5	—	
AS12□1F-U10-32-06	10-32UNF	6	—	—	—	—	—	—	18.1	22.9	11.7	—	13.5	—	
AS22□1F-01-23	—	3.2	—	—	—	9.3	—	—	20.4	27.5	—	—	12.7	16	
AS22□1F-01-04	—	4	—	—	—	9.3	—	—	20.4	27.5	—	—	12.7	16	
AS22□1F-01-06	—	6	1/8	12 (12.7)	—	11.6	14.2	—	20.4	27.5	—	—	17	—	
AS22□1F-01-08	—	8	—	—	—	15.2	—	—	25.3	32.4	—	—	18.5	19	
AS22□1F-01-10	—	10	—	—	—	18.5	—	—	32.1	39.2	14.1	—	21	21	
AS22□1F-02-04	—	4	—	—	—	12.8	—	—	25.2	34.4	—	—	16	32	
AS22□1F-02-06	—	6	—	—	17	12.8	18.5	—	25.2	34.4	17.7	—	17	—	
AS22□1F-02-08	—	8	—	—	17.5	15.2	—	—	27.2	36.4	—	39.9	34.9	34.4	29.4
AS22□1F-02-10	—	10	—	—	—	18.5	—	—	35.3	44.5	18.3	—	21	36	
AS22□1F-02-06	—	6	—	—	1/4	12.8	—	—	27.8	39.3	—	—	17	60	
AS32□1F-02-08	—	8	—	—	—	15.2	23	—	29.5	41	21.3	48.3	43.3	42.8	37.8
AS32□1F-02-10	—	10	—	—	—	18.5	—	—	31.8	43.3	—	—	21	67	
AS32□1F-02-12	—	12	—	—	—	20.9	—	—	32.8	44.3	—	—	22	69	
AS32□1F-03-06	—	6	—	—	—	12.8	—	—	27.8	39.3	—	—	17	55	
AS32□1F-03-08	—	8	—	—	—	15.2	—	—	29.5	41	—	—	18.5	57	
AS32□1F-03-10	—	10	—	—	—	18.5	23	—	31.8	43.3	19.8	45.4	40.4	40.2	35.2
AS42□1F-03-12	—	12	—	—	—	20.9	—	—	32.8	44.3	—	—	22	61	
AS42□1F-04-10	—	10	—	—	—	15.2	—	—	33.6	47.9	—	—	21	100	
AS42□1F-04-12	—	12	1/2	24 (23.8)	28.6	—	—	—	35.2	49.5	24.5	56.7	49.2	48.6	42.1

Note 1) () are the dimensions of NPT thread. Note 2) Reference thread dimensions after installation. Note 3) Reference dimensions

Inch Size

Model	Applicable tubing O.D. (øE)	T	H (1)	D1	D2	L3	L1	L2	L4 (3)	A (2)		M1	Weight (g)			
										Max.	Min.					
AS12□1F-M3-01	1/8"	M3 x 0.5	5.5	8.4	9.3	7.2	16.1	19.7	10.5	26.6	24.1	24	21.5	12.7	4	
AS12□1F-M5-01	5/32"	M5 x 0.8	7	8.4	9.6	17.3	22.1	—	12.3	28.6	25.8	25	22.2	12.7	7	
AS12□1F-M3-02	1/8"	10-32UNF	8	8.4	9.6	17.3	22.1	—	12.3	28.6	25.8	25	22.2	12.7	7	
AS12□1F-M5-02	5/32"	M5 x 0.8	8	8.4	9.6	17.3	22.1	—	12.3	28.6	25.8	25	22.2	12.7	7	
AS12□1F-U10-32-02	5/32"	10-32UNF	8	8.4	9.6	17.3	22.1	—	12.3	28.6	25.8	25	22.2	12.7	7	
AS12□1F-M5-05	3/16"	M5 x 0.8	8	11.4	11.4	21.3	26.1	—	11.7	28.6	25.8	25	22.2	—	16.5	7
AS12□1F-U10-32-05	3/16"	10-32UNF	8	11.4	11.4	21.3	26.1	—	11.7	28.6	25.8	25	22.2	—	16.5	7
AS12□1F-M5-07	1/4"	M5 x 0.8	12	9.6	9.6	18.3	23.1	—	12	28.6	25.8	25	22.2	—	13.5	7
AS12□1F-U10-32-07	1/4"	10-32UNF	12	9.6	9.6	18.3	23.1	—	12	28.6	25.8	25	22.2	—	13.5	7
AS22□1F-01-01	1/8"	—	12 (12.7)	9.3	—	9.3	—	—	20.4	27.5	—	—	12.7	16		
AS22□1F-01-03	5/32"	—	12 (12.7)	9.3	—	9.3	—	—	20.4	27.5	—	—	12.7	16		
AS22□1F-01-05	3/16"	—	12 (12.7)	11.4	14.2	23.1	30.2	13.4	35.2	30.2	32.1	27.1	16.5	17		
AS22□1F-01-05	3/16"	—	12 (12.7)	11.4	14.2	23.1	30.2	13.4	35.2	30.2	32.1	27.1	16.5	17		
AS22□1F-01-07	1/4"	—	12 (12.7)	13.2	—	23.9	31	—	—	—	—	—	18.5	19		
AS22□1F-01-09	5/16"	—	12 (12.7)	15.2	—	25.3	32.4	14.1	—	—	—	—	21	21		
AS22□1F-01-09	5/16"	—	12 (12.7)	15.2	—	25.3	32.4	14.1	—	—	—	—	21	21		
AS22□1F-02-03	5/32"	—	17 (17.5)	10.4	—	25.2	34.4	—	—	—	—	—	16	32		
AS22□1F-02-05	3/16"	—	17 (17.5)	11.4	—	24.9	34.2	17.7	—	—	—	—	17	—		
AS22□1F-02-07	1/4"	—	17 (17.5)	13.2	18.5	25.2	34.5	—	39.9	34.9	34.4	29.4	18.5	34		
AS22□1F-02-09	5/16"	—	17 (17.5)	15.2	—	27.2	36.4	18.2	—	—	—	—	21	36		
AS22□1F-02-09	5/16"	—	17 (17.5)	15.2	—	27.2	36.4	18.2	—	—	—	—	21	36		
AS22□1F-02-11	3/8"	—	1/4	18.5	—	35.3	44.5	18.8	—	—	—	—	21	36		
AS22□1F-02-07	1/4"	—	1/4	13.2	—	27.8	39.3	—	—	—	—	—	17	60		
AS32□1F-02-07	1/4"	—	1/4	13.2	23	29.5	41	21.3	48.3	43.3	42.8	37.8	18.5	63		
AS32□1F-02-09	5/16"	—	1/4	15.2	23	29.5	41	21.3	48.3	43.3	42.8	37.8	18.5	63		
AS32□1F-02-11	3/8"	—	1/4	17.9	—	31.8	43.3	—	—	—	—	—	21	67		
AS32□1F-03-07	1/4"	—	1/4	13.2	23	29.5	39.3	—	—	—	—	—	17	55		
AS32□1F-03-09	5/16"	—	3/8	15.2	23	29.5	41	19.8	45.4	40.4	40.2	35.2	18.5	57		
AS32□1F-03-11	3/8"	—	3/8	17.9	—	31.8	43.3	—	—	—	—	—	21	59		
AS42□1F-03-11	3/8"	—	1/2	17.9	—	33.6	47.9	—	—	—	—	—	21	100		
AS42□1F-04-11	1/2"	—	1/2	21.7	28.6	35.2	49.5	24.5	56.7	49.2	49.6	42.1	21	100		

Note 1) () are the dimensions of NPT thread. Note 2) Reference thread dimensions after installation. Note 3) Reference dimensions

Speed Controller with One-touch Fitting Elbow Type/Universal Type **AS Series**



Universal Type

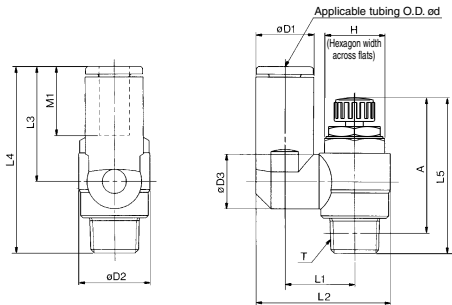

M3 port
M5 port
U10/32 port

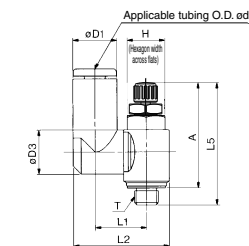
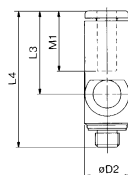

Metric Size

Model	Applicable tubing O.D. (mm)	T	H ⁽¹⁾	D1	D2	D3	L1	L2	L3	L4	L5 ⁽²⁾		A ⁽²⁾		M1	Weight (g)
											Max.	Min.	Max.	Min.		
AS13□1F-M3-23	3.2	M3 x 0.5	5.5	8.4	7.2	7.2	10.1	17.9	17.6	28.3	26.6	24.1	24	21.5	12.7	4
AS13□1F-M3-04	4	M3 x 0.5		9.3	7.2			18.3	17.9	28.6						5
AS13□1F-M5-23	3.2	M5 x 0.8		8.4				19.8							12.7	
AS13□1F-U10/32-23	4	10-32UNF		8.4				19.8							12.7	
AS13□1F-M5-04	4	M5 x 0.8		9.3	9.6	9.3	10.8	20.3			28.6	25.8	25	22.2		7
AS13□1F-U10/32-04	4	10-32UNF		9.3	9.6	9.3	10.8	20.3			28.6	25.8	25	22.2		7
AS13□1F-M5-06	6	M5 x 0.8		11.6				21.4	20.6	31.8					13.5	
AS13□1F-U10/32-06	6	10-32UNF		11.6				21.4	20.6	31.8					13.5	
AS23□1F-01-23	3.2			8.4				13.1	24.4		35.2	30.2	32.1	27.1	12.7	17
AS23□1F-01-04	4			9.3				14.2	24.9		35.2	30.2	32.1	27.1	13.5	18
AS23□1F-01-06	6	1/8	12 (12.7)	11.6				14.2	26.9	22.9	36.3				13.5	18
AS23□1F-01-08	8			15.2				12.9	16.2	30.9	28.2	40.8			18.5	21
AS23□1F-02-04	4			10.4				10.9	16.2	30.6	21.9	39.6			16	32
AS23□1F-02-06	6			12.8				12.9	18.4	34	25.2	42.1			17	33
AS23□1F-02-08	8		17 (17.5)	15.2	18.5			12.9	18.3	35.2	28.2	45.1			18.5	36
AS23□1F-02-10	10			18.5				12.9	20.2	38.7	31	47.9			21	40
AS23□1F-02-12	12			18.5				12.9	20.6	39.5	25.2	45.5			21	40
AS33□1F-02-06	6		1/4	12.8				12.9	20.6	38.5	28.2	48.5			17	60
AS33□1F-02-08	8			15.2				12.9	20.6	39.7	28.2	49.5			18.5	63
AS33□1F-02-10	10			18.5				12.9	20.6	39.7	28.2	49.5	48.3	42.8	37.8	65
AS33□1F-02-12	12			20.9				12.9	20.6	39.7	28.2	49.5			22	69
AS33□1F-03-06	6			12.8				12.9	20.6	38.5	25.2	45			17	56
AS33□1F-03-08	8			15.2				12.9	20.6	39.7	28.2	48			18.5	59
AS33□1F-03-10	10			18.5				12.9	20.6	39.7	28.2	48	45.4	40.4	40	65
AS33□1F-03-12	12			20.9				12.9	20.6	39.7	28.2	48			22	65
AS43□1F-04-10	10	1/2	24 (23.8)	18.5	28.6			16.2	25.8	49.4	32.6	57.1			21	104
AS43□1F-04-12	12		21.7	19.4	26.8	52		16.2	25.8	49.4	32.6	57.1			22	106

Note 1 () are the dimensions of NPT thread
 Note 2) Reference thread dimensions after installation.
 Note 3) Reference dimensions

Inch Size

Model	Applicable tubing O.D. (in)	T	H ⁽¹⁾	D1	D2	D3	L1	L2	L3	L4	L5 ⁽²⁾		A ⁽²⁾		M1	Weight (g)
											Max.	Min.	Max.	Min.		
AS13□1F-M3-01	1/8"	M3 x 0.5	5.5	8.4	7.2	7.2	10.1	17.9	17.6	28.3	26.6	24.1	24	21.5	12.7	4
AS13□1F-M3-03	3/32"	M3 x 0.5		9.3	7.2			18.3	17.9	28.6						5
AS13□1F-M5-01	1/8"	M5 x 0.8		8.4				19.8							12.7	
AS13□1F-U10/32-01	1/8"	10-32UNF		8.4				19.8							12.7	
AS13□1F-M5-03	5/32"	M5 x 0.8		9.3	9.6	9.3	10.8	20.3			28.6	25.8	25	22.2		7
AS13□1F-U10/32-03	5/32"	10-32UNF		9.3	9.6	9.3	10.8	20.3			28.6	25.8	25	22.2		7
AS13□1F-M5-05	3/16"	M5 x 0.8		11.4				21.3	23.3	34.5					16.5	
AS13□1F-U10/32-05	3/16"	10-32UNF		11.4				21.3	23.3	34.5					16.5	
AS13□1F-M5-07	1/4"	M5 x 0.8		12				21.6	20.7	31.9					13.7	
AS13□1F-U10/32-07	1/4"	10-32UNF		12				21.6	20.7	31.9					13.7	
AS23□1F-01-01	1/8"			8.4				9.3	13.1	24.4					12.7	17
AS23□1F-01-03	5/32"			9.3				9.3	13.1	24.9					12.7	17
AS23□1F-01-05	3/16"	1/8	12 (12.7)	11.6	14.2			10.9	14	26.8	23.9	37.3	35.2	30.2	32.1	16.5
AS23□1F-01-07	1/4"			13.2				12.9	16.2	29.9	25.6	38.2			17	19
AS23□1F-01-09	5/16"			15.2				12.9	16.2	30.9	28.2	40.8			18.5	21
AS23□1F-02-03	5/32"			10.4				10.9	16.2	30.6	21.9	39.6			16	32
AS23□1F-02-05	3/16"			11.6				10.9	16.2	31.1	23.9	42.1			16.5	33
AS23□1F-02-07	1/4"		17 (17.5)	13.2	18.5			12.9	18.3	34.2	25.6	45.1	39.9	34.9	34.4	29.4
AS23□1F-02-09	5/16"			15.2				12.9	18.3	35.2	28.2	47.9			18.5	39
AS23□1F-02-11	3/8"			18.5				12.9	20.2	38.7	31	46.5			21	40
AS33□1F-02-07	1/4"			13.2				12.9	20.6	38.7	25.6	46.9			17	60
AS33□1F-02-09	5/16"			15.2	23			12.9	20.6	39.7	28.2	49.5	48.3	43.3	42.8	37.8
AS33□1F-02-11	3/8"			18.5				12.9	20.6	39.7	28.2	49.5			21	69
AS33□1F-03-07	1/4"			13.2				12.9	20.6	38.7	25.6	45.4			17	56
AS33□1F-03-09	5/16"			15.2	23			12.9	20.6	39.7	28.2	48	45.4	40.4	40.2	35.2
AS33□1F-03-11	3/8"			18.5				12.9	20.6	39.7	28.2	49.5			21	65
AS43□1F-04-11	3/8"			24	18.5	28.6		16.2	25.8	49.4	32.6	57.1			21	104
AS43□1F-04-13	1/2"		21.7	19.4	26.8	52		16.2	25.8	49.4	32.6	57.1			22	106

Note 1 () are the dimensions of NPT thread
 Note 2) Reference thread dimensions after installation.
 Note 3) Reference dimensions

Please contact SMC for detailed dimensions, specifications and lead times.



1 Lubricant: Vaseline X12

Ex.) AS2201F-01-04S-X12

2 Grease-free (Seal: Fluorine Coating) + Throttle Valve (Without Check Valve) X21

Ex.) AS2201F-01-04S-X21

Note 1) Not particle-free

Note 2) Throttle valve is only compatible with the part no. of the meter-out type.

3 Throttle Valve (Without Check Valve) X214

Ex.) AS2201F-01-04S-X214

Note) Throttle valve is only compatible with the part no. of the meter-out type.

4 Fixed Throttle (No needle function) X250

How to Order

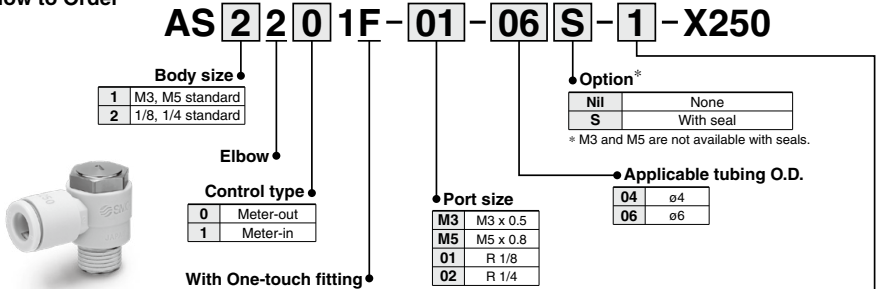

Symbol	Fixed orifice	Applicable model			
		AS12□1F-M3-04	AS12□1F-M5-04 AS12□1F-M5-06	AS22□1F-01-04 AS22□1F-01-06	AS22□1F-02-06
1	ø0.1	●	●	●	●
2	ø0.2	●	●	●	●
3	ø0.3	●	●	●	●
4	ø0.4	●	●	●	●
5	ø0.5	●	●	●	●
6	ø0.6	●	●	●	●
7	ø0.7	●	●	●	●
8	ø0.8	●	●	●	●
9	ø0.9	●	●	●	●
10	ø1.0	●	●	●	●

The graph below shows the relationship between orifices for each cylinder bore and cylinder speed. Please refer to it during selection. The cylinder speeds on the graph are theoretical values. Actual values may differ depending on the piping conditions or sliding friction, so please use this graph as a guideline only.

