

# RJ45 Single Port 10GBase-T Magnetic Module

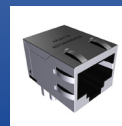

ARJM11E-B5754NNEWCB

21.2 x 15.9 x 13.5 mm  
RoHS/RoHS II Compliant  
MSL = 1

## Features

- Single Port RJ45 with Magnetics
- Supports speed up to 10 Gbps
- Operating temperature range up to 0°C to +70°C
- Different Gold plating options
- Compatible with major IC's for Ethernet applications
- High performance magnetics for EMI suppression and common mode noise rejection
- 1CT:1CT TX and RX Transformers

## Applications

- Fast and gigabit Ethernet
- Hubs, Servers, Switches, Routers, Access points
- IP cameras, surveillance, and phone
- Industrial computers and robotics
- Networking and communications
- Broadcast video
- Set top box
- Test and Measurement

## Electrical Specifications

| Parameters         | Minimum | Typical | Maximum | Units | Notes                           |
|--------------------|---------|---------|---------|-------|---------------------------------|
| Inductance         | 120     |         |         | μH    | 100 kHz, 0.1V with 8 mA DC Bias |
| Leakage Inductance |         |         | 0.4     | μH    | 100 kHz, 0.1V                   |
| DC Resistance      |         |         | 1.2     | Ω     |                                 |
| Hi-pot             | 2250    |         |         | VDC   | 60 s                            |
| Insertion Loss     |         |         | 3.0     | dB    | 0.1 MHz                         |
|                    |         |         | 2.0     |       | 1-400 MHz                       |
| Return Loss        | 20      |         |         | dB    | 1-100 MHz                       |
|                    | 10      |         |         |       | 100-300 MHz                     |
|                    | 7.5     |         |         |       | 300-500 MHz                     |
| Crosstalk          | 25      |         |         | dB    | 1-100 MHz                       |
|                    | 15      |         |         |       | 100-500 MHz                     |
| CMR                | 25      |         |         | dB    | 1-100 MHz                       |
|                    | 20      |         |         |       | 100-500 MHz                     |
| DCR                | 30      |         |         | dB    | 1-100MHz                        |
|                    | 20      |         |         |       | 100-500 MHz                     |
| Turn Ratio         | 1CT:1CT |         |         |       | ± 2%                            |

\*f represents the test frequency specified in MHz

# RJ45 Single Port 10GBase-T Magnetic Module

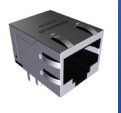

ARJM11E-B5754NNEWCB

21.2 x 15.9 x 13.5 mm  
RoHS/RoHS II Compliant  
MSL = 1

## Material Specifications

| Parameter   | Specification   |                                  |
|-------------|---|----------------------------------|
| Housing     | Material (Housing)  | Glass Filled PA46, Black         |
|             | Flammability Rating   | UL94V-0 (RoHS)                   |
| Contact     | Material  | Phosphor Bronze, 50-100 u" (min) |
|             | Plating (1)   | Nickel                           |
|             | Plating (2)   | 50 u" Gold*                      |
| Shield      | Material  | Brass, 0.2mm                     |
| Jack Cavity | In conformance with the FCC Rules and Regulations Part 68 Subpart F |                                  |

\*For alternative Gold plating thickness, please contact ABRACON.

## Environmental Specifications

| Parameters            | Specification    |
|-----------------------|------------------|
| RoHS                  | RoHS Compliant   |
| MSL                   | 1                |
| Operating Temperature | 0 °C to +70 °C   |
| Storage Temperature   | -40 °C to +85 °C |

# RJ45 Single Port 10GBase-T Magnetic Module

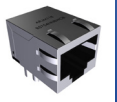

ARJM11E-B5754NNEWCB

21.2 x 15.9 x 13.5 mm  
RoHS/RoHS II Compliant  
MSL = 1

## Mechanical Dimensions

W Shield, W EMI Fingers, Tab Down

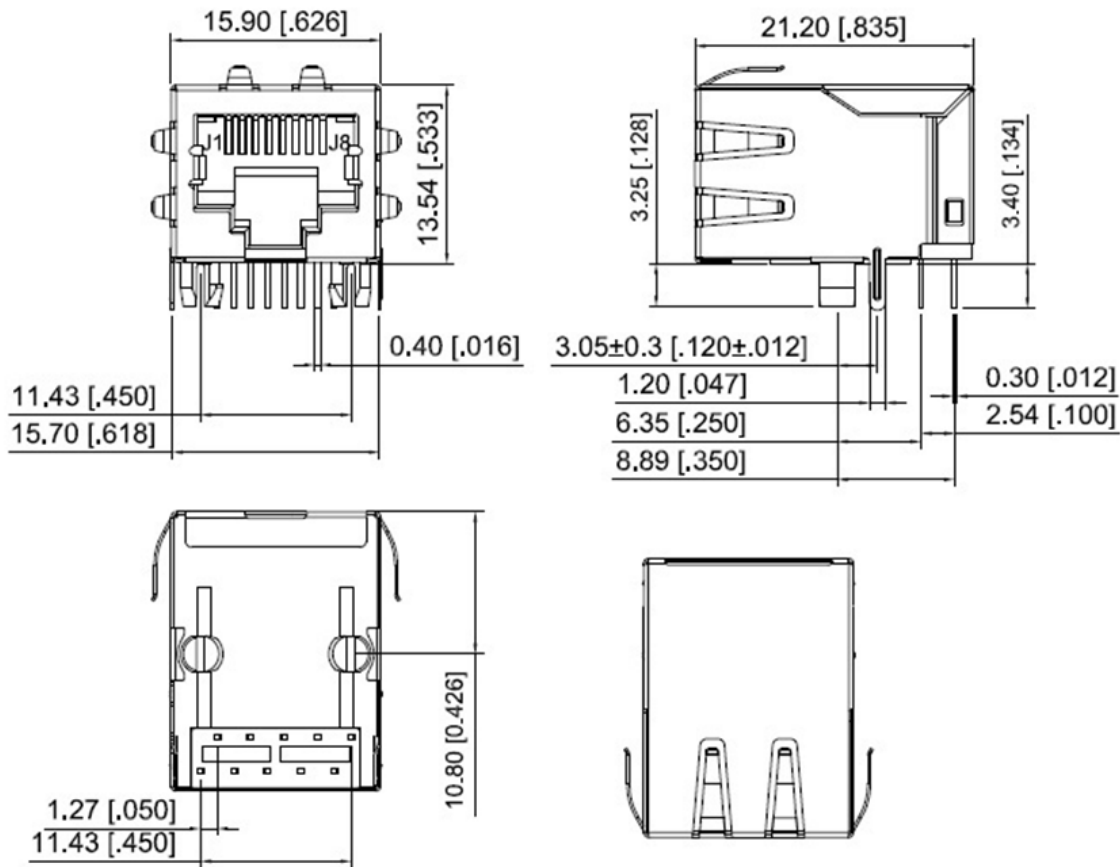

Dimensions: mm[inch]  
(Unless otherwise specified, all tolerances are ±0.25[0.010])

# RJ45 Single Port 10GBase-T Magnetic Module

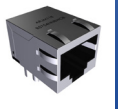

ARJM11E-B5754NNEWCB

21.2 x 15.9 x 13.5 mm  
RoHS/RoHS II Compliant  
MSL = 1

## Mechanical Dimensions

### Pin Layout

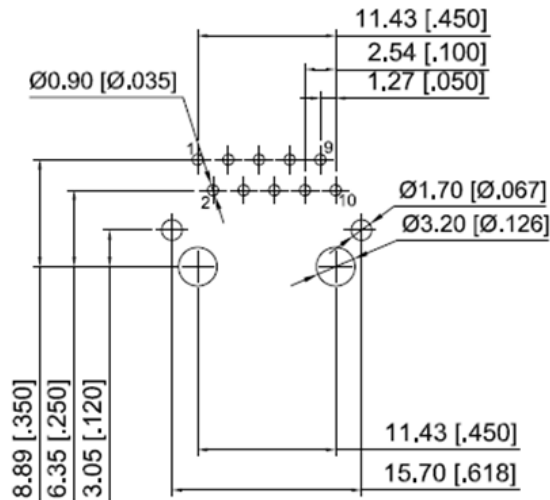

Dimensions: mm[inch]  
(Unless otherwise specified, all tolerances are  $\pm 0.05$ [0.002])

## Schematic

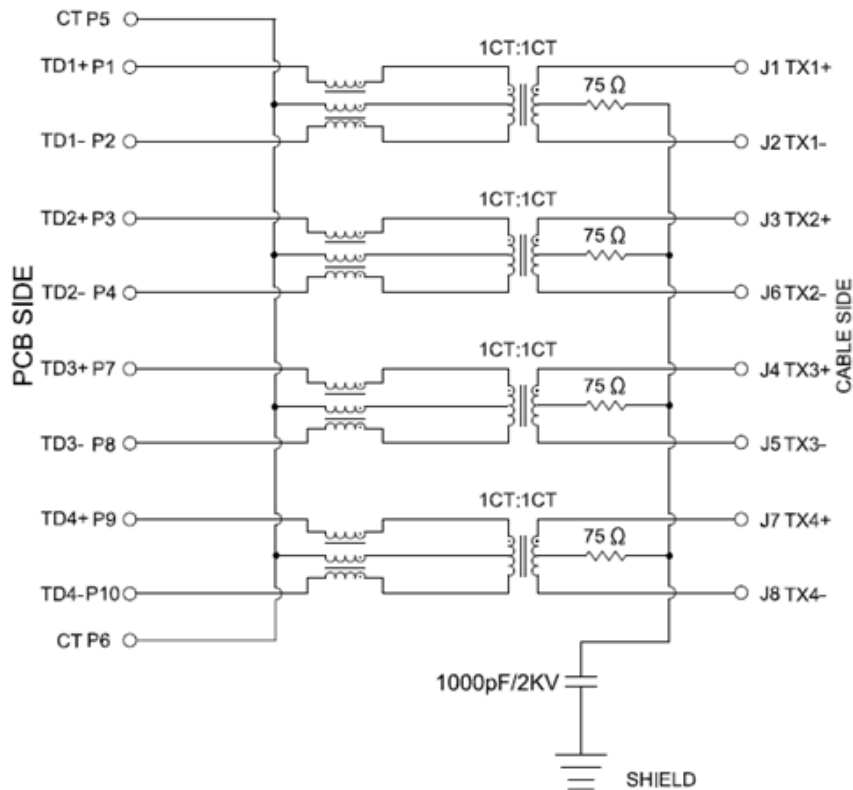

# RJ45 Single Port 10GBase-T Magnetic Module



ARJM11E-B5754NNEWCB

21.2 x 15.9 x 13.5 mm  
RoHS/RoHS II Compliant  
MSL = 1

## Wave Soldering Profile

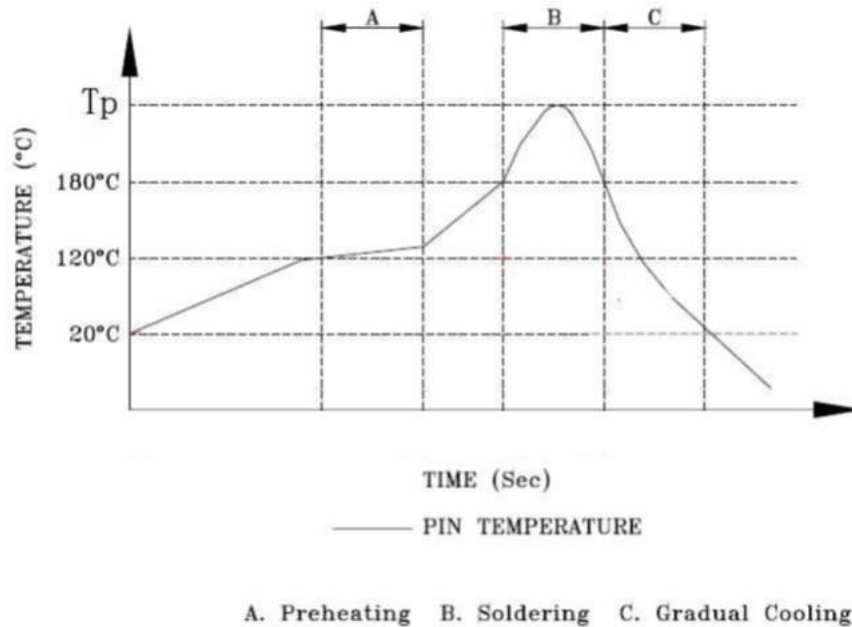

Peak Temperature ( $T_p$ ) = 260 °C (max)  
Peak Time ( $t_p$ ) = 10 s (max)

## Packaging

Pieces per Carton : 2000  
Bulk/Tray per Carton : 50  
Pieces per Bulk/Tray : 15 Kg  
Dimension of the Carton: 535 x 305 x 240 mm

**ATTENTION:** Abracon LLC's products are COTS – Commercial-Off-The-Shelf products; suitable for Commercial, Industrial and, where designated, Automotive Applications. Abracon's products are not specifically designed for Military, Aviation, Aerospace, Life-dependent Medical applications or any application requiring high reliability where component failure could result in loss of life and/or property. For applications requiring high reliability and/or presenting an extreme operating environment, written consent and authorization from Abracon LLC is required. Please contact Abracon LLC for more information.



5101 Hidden Creek Ln Spicewood TX 78669  
Phone: 512-371-6159 | Fax: 512-351-8858  
For terms and conditions of sales, please visit:  
[www.abracon.com](http://www.abracon.com)

REVISED: 10.04.2019

ABRACON IS  
ISO9001-2015  
CERTIFIED