

mm inch

### FEATURES

**1. Conforms to European safety standards (VDE0110)**

dielectric distance between input and output

- Creepage distance: Min. 3.0 mm
- Clearances distance: Min. 2.5 mm

**2. The small-sized slim type**

28 mm (L)×5 mm (W)×15 mm (H)  
1.063 inch (L)×.197 inch (W)×.591 inch (H)  
permits high density mounting to PC board

**3. High dielectric strength: 2,500V AC**  
(between input and output)

**4. Two load types available:**

- DC output type (3A)
- AC output type (1A)

**5. Zero-cross type are available (AC type)**

The zero-cross type generates minimal noise

**6. Snubber circuit integrated (AC type)**

The snubber circuit is integrated to prevent malfunction caused by the rapid rise of voltage on the output side, such as inductive load and current.

**RoHS Directive compatibility information**  
<http://www.nais-e.com/>

### TYPES

Type	Load voltage	Input voltage	Part No.
AC output	75 to 250 V AC	5 V DC	AQE12105
		12 V DC	AQE12112
		24 V DC	AQE12124
DC output	3 to 60 V DC	5 V DC	AQE34205
		12 V DC	AQE34212
		24 V DC	AQE34224

### TYPICAL APPLICATIONS

- Interface relays for programmable controllers
- Industrial equipment
- Timers and counters
- Air conditioners

### ORDERING INFORMATION

Ex. AQE 1 2 1 0 5

Load current	Load voltage	Type	Input voltage
1: 1 A 3: 3 A	2: 75 to 250 V AC 4: 3 to 60 V DC	1: AC output (Zero-cross) 2: DC output	05: 5 V DC 12: 12 V DC 24: 24 V DC

(Note) Standard packing: Carton 20 pcs., Case 1,000 pcs.

# AQ-E

## SPECIFICATIONS

Ratings (at 20°C 68°F, Input voltage ripple: 1% or less)

Item	Type	AC output			DC output			Remarks
	Part No.	AQE12105	AQE12112	AQE12124	AQE34205	AQE34212	AQE34224	
Input side	Input voltage	4 to 6 V DC	9.6 to 14.4 V DC	21.6 to 26.4 V DC	4 to 6 V DC	9.6 to 14.4 V DC	21.6 to 26.4 V DC	
	Input impedance	Approx. 0.5k Ω	Approx. 1.3k Ω	Approx. 3k Ω	Approx. 0.5k Ω	Approx. 1.3k Ω	Approx. 3k Ω	
	Drop-out voltage, min.	0.5 V DC	1.2 V DC	2.4 V DC	0.5 V DC	1.2 V DC	2.4 V DC	
	Reverse voltage	3 V						
Load side	Max. load current	1 A AC			3 A DC			
	Load voltage	75 to 250 V AC			3 to 60 V DC			
	Frequency	45 to 65 Hz			—			
	Non-repetitive surge current	20 A			15 A			AC: In one cycle at 60 Hz DC: 10 ms
	Max. "OFF-state" leakage current	1.5 mA (applied 200 V)			10μA			
	Max. "ON-state" voltage drop	1.6 V			0.3 V			at Max. carrying current
	Min. load current	20 mA			1 mA			
	OFF state dV/dt	50 V/μs			—			
	Max. operating speed	—			0.5cps.			at rated operating voltage, rated load voltage and current

Characteristics (at 20°C 68°F, Input voltage ripple: 1% or less)

Item	AC output	DC output	Remarks
Operate time max.	(1/2 cycle of voltage sine wave) + 1 ms	2 ms	
Release time, max.	(1/2 cycle of voltage sine wave) + 1 ms	0.4 ms	
Insulation resistance, min.	10 <sup>9</sup> Ω between input and output		Using 500 V DC megger
Breakdown voltage	2,500 Vrms between input and output		Initial for 1 min.
Vibration resistance	Functional	10 to 55 Hz double amplitude of 1.5 mm	
	Destructive	10 to 55 Hz double amplitude of 1.5 mm	
Shock resistance	Functional	Min. 490 m/s <sup>2</sup> {50 G}	
	Destructive	Min. 490 m/s <sup>2</sup> {50 G}	
Ambient temperature	-30°C to +80°C -22°F to +176°F		
Storage temperature	-30°C to +100°C -22°F to +212°F		
Operational method	Zero-cross (Turn-ON and Turn-OFF)	—	

## DIMENSIONS

mm inch

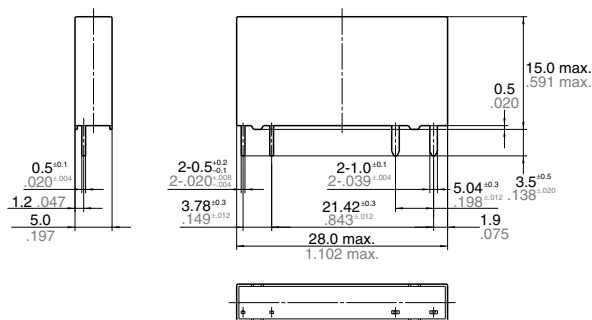

Mounting hole location (Bottom view)

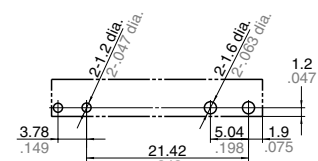

Tolerance: ±0.1 ±.004

Schematic AC type



DC type



**REFERENCE DATA**

1. Load current vs. ambient temperature

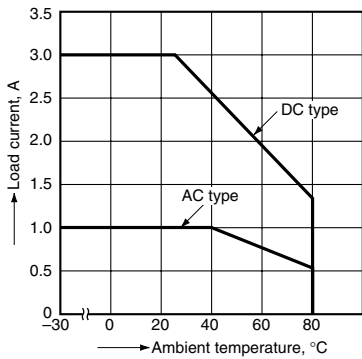

2.-(1) Non-repetitive surge current vs. carrying time (AC output)

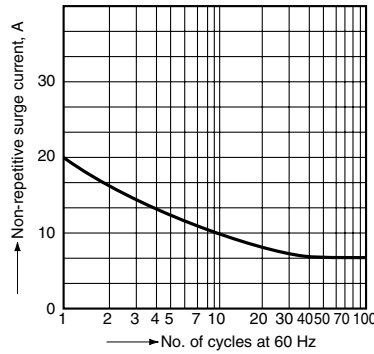

2.-(2) Non-repetitive surge current vs. carrying time (DC output)

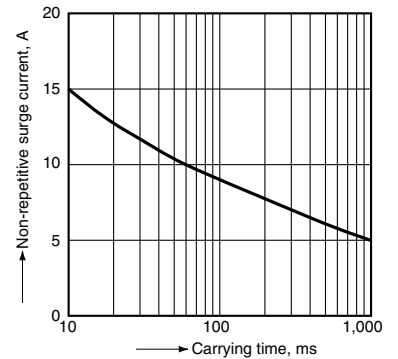

3. Input current vs. input voltage characteristics

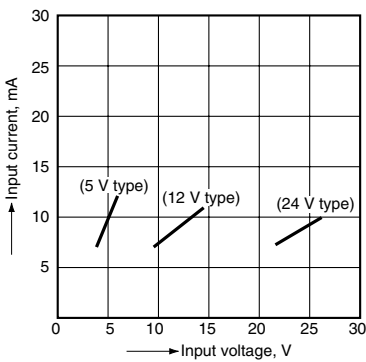

4.-(1) Load current vs. ambient temperature characteristics for adjacent mounting (AC output)

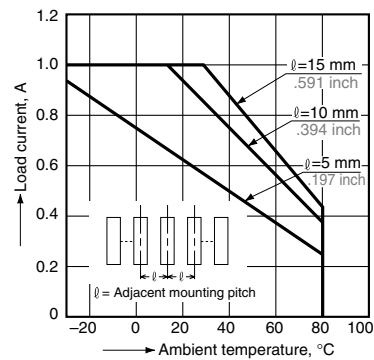

4.-(2) Load current vs. ambient temperature characteristics for adjacent mounting (DC output)

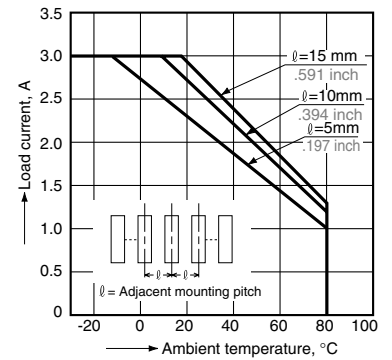

**For Cautions for Use**