

Part Number: APT1608ZGC-AMT

Green



ATTENTION
OBSERVE PRECAUTIONS
FOR HANDLING
ELECTROSTATIC
DISCHARGE
SENSITIVE
DEVICES

Features

- High reliability LED package.
- 1.6mmx0.8mm SMT LED, 0.75mm thickness.
- Low power consumption.
- Wide viewing angle.
- Ideal for backlight and indicator.
- Various colors and lens types available.
- Package: 2000pcs / reel .
- Moisture sensitivity level : level 3.
- RoHS compliant.

Package Dimensions

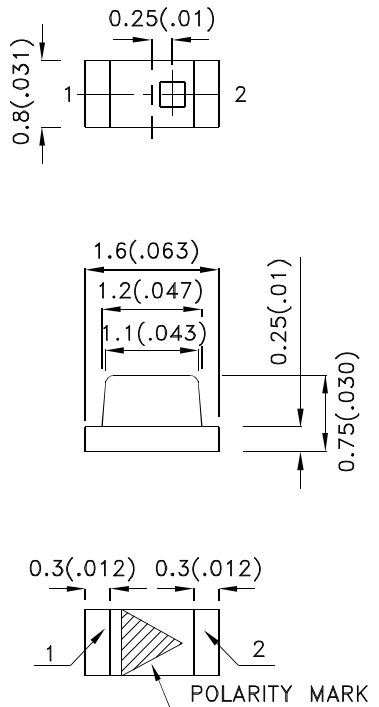

Description

The Green source color devices are made with InGaN on Sapphire Light Emitting Diode.

Static electricity and surge damage the LEDs.

It is recommended to use a wrist band or anti-electrostatic glove when handling the LEDs.

All devices, equipment and machinery must be electrically grounded.

Applications

- Traffic signaling.
- Backlighting (illuminated advertising , general lighting).
- Interior and exterior automotive lighting.
- Substitution of micro incandescent lamps.
- Reading lamps.
- Signal and symbol luminaire for orientation.
- Marker lights (e.g. Steps, exit ways, etc).
- Decorative and entertainment lighting.
- Indoor and outdoor commercial and residential architectural lighting.

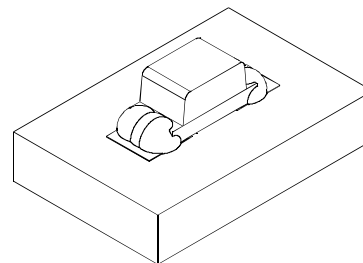
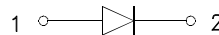

Notes:

1. All dimensions are in millimeters (inches).
2. Tolerance is $\pm 0.1(0.004)$ unless otherwise noted.
3. The specifications, characteristics and technical data described in the datasheet are subject to change without prior notice.
4. The device has a single mounting surface. The device must be mounted according to the specifications.



Selection Guide

Part No.	Dice	Lens Type	Iv (mcd) [2] @ 20mA			Viewing Angle [1]
			Code.	Min.	Max.	2θ1/2
APT1608ZGC-AMT	Green (InGaN)	Water Clear	Q	300	400	120°
			R	400	500	
			S	500	700	

Notes:

1. θ1/2 is the angle from optical centerline where the luminous intensity is 1/2 of the optical peak value.
2. Luminous intensity/ luminous Flux: +/-15%.

Absolute Maximum Ratings at Ta=25°C

Parameter	Symbol	Value	Unit
Power dissipation	P _D	82	mW
Reverse Voltage	V _R	5	V
Junction temperature	T _J	110	°C
Operating Temperature	Top	-40 To +100	°C
Storage Temperature	T _{stg}	-40 To +110	°C
DC Forward Current[1]	I _F	20	mA
Peak Forward Current [2]	I _{FM}	150	mA
Electrostatic Discharge Threshold (HBM)		450	V
Thermal Resistance (Junction/ambient) [1]	R _{th j-a}	350	°C/W

Notes:

1. R_{th(j-a)} Results from mounting on PC board FR4 (pad size ≥ 16 mm² per pad),
2. 1/10 Duty Cycle, 0.1ms Pulse Width.

Electrical / Optical Characteristics at Ta=25°C

Parameter	Symbol	Value				Unit
		Code.	Min.	Typ.	Max.	
Wavelength at peak emission I _F =20mA	λ _{peak}			515		nm
Dominant Wavelength I _F =20mA	λ _{dom} [1]	1	513		522	nm
		2	518		527	
		3	523		532	
		4	528		537	
Spectral bandwidth at 50%Φ _{REL MAX} I _F =20mA	Δλ			30		nm
Forward Voltage I _F =20mA	V _F [2]			3.3	4.1	V
Reverse Current (V _R = 5V)	I _R				50	uA
Temperature coefficient of λ _{peak} I _F =20mA, -10 ° C ≤ T ≤ 100 ° C	TC λ _{peak}			0.09		nm/° C
Temperature coefficient of λ _{dom} I _F =20mA, -10 ° C ≤ T ≤ 100 ° C	TC λ _{dom}			0.05		nm/° C
Temperature coefficient of V _F I _F =20mA, -10 ° C ≤ T ≤ 100 ° C	TC _V			-2.5		mV/° C

Notes:

1. The dominant Wavelength (λ_d) above is the setup value of the sorting machine. (Tolerance λ_d : ±1nm.)
2. Forward Voltage: +/-0.1V.

Green

APT1608ZGC-AMT

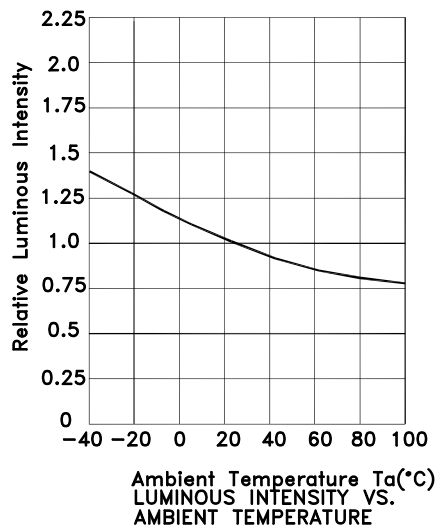
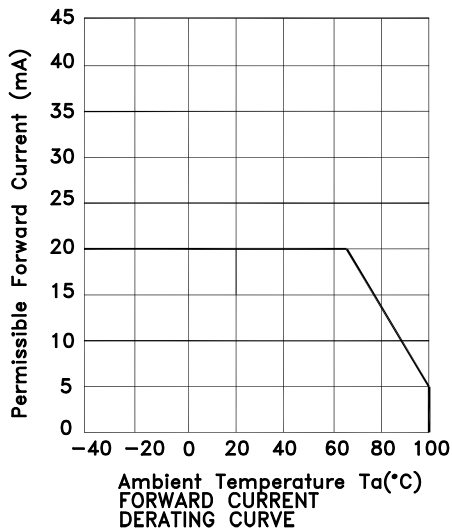
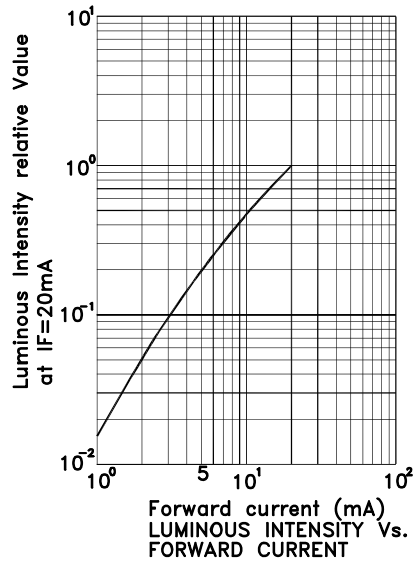
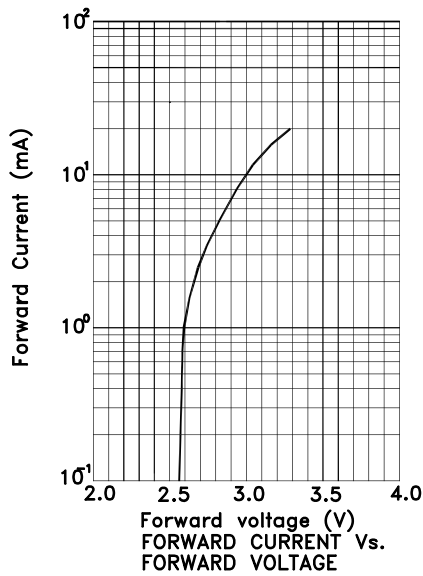
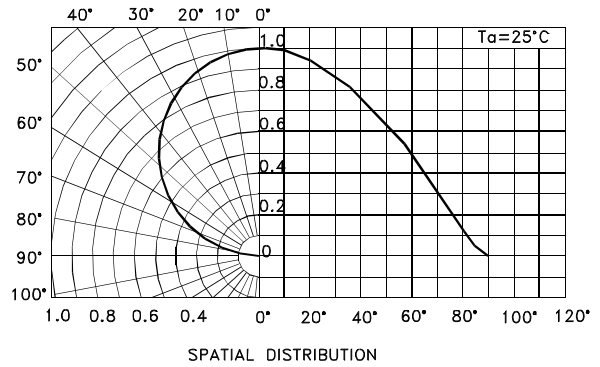
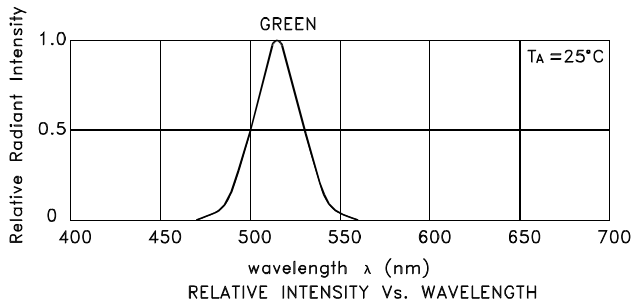

APT1608ZGC-AMT

Reflow soldering is recommended and the soldering profile is shown below.
Other soldering methods are not recommended as they might cause damage to the product.

Reflow Soldering Profile For Lead-free SMT Process.

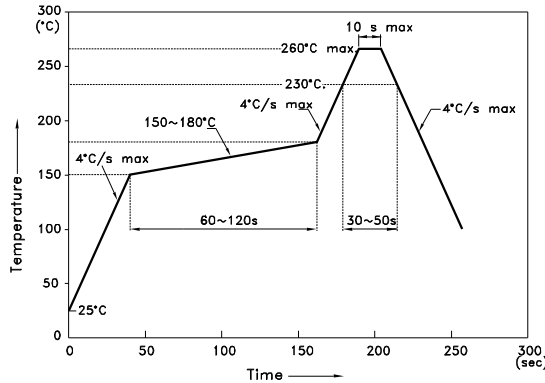

NOTES:

1. We recommend the reflow temperature 245°C(+/-5°C). The maximum soldering temperature should be limited to 260°C.
2. Don't cause stress to the epoxy resin while it is exposed to high temperature.
3. Number of reflow process shall be 2 times or less.

Recommended Soldering Pattern (Units : mm; Tolerance: ± 0.1)

Pad design for improved heat dissipation

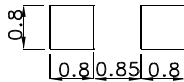

Cu-area ≥ 16mm²
per pad

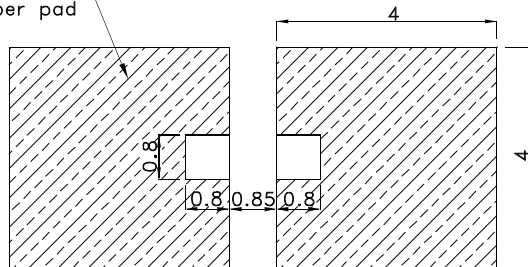

Solder resist

Tape Specifications (Units : mm)

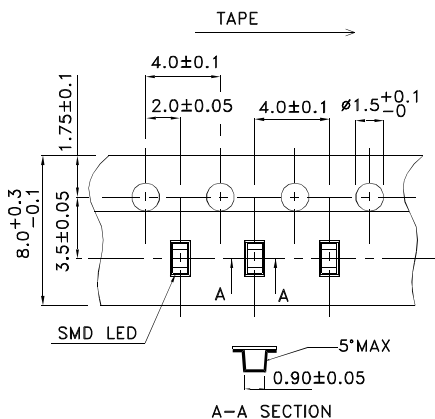

Reel Dimension

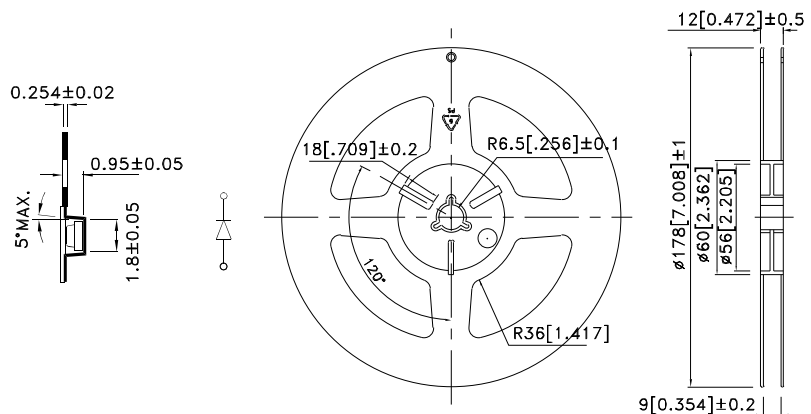

PACKING & LABEL SPECIFICATIONS

APT1608ZGC-AMT

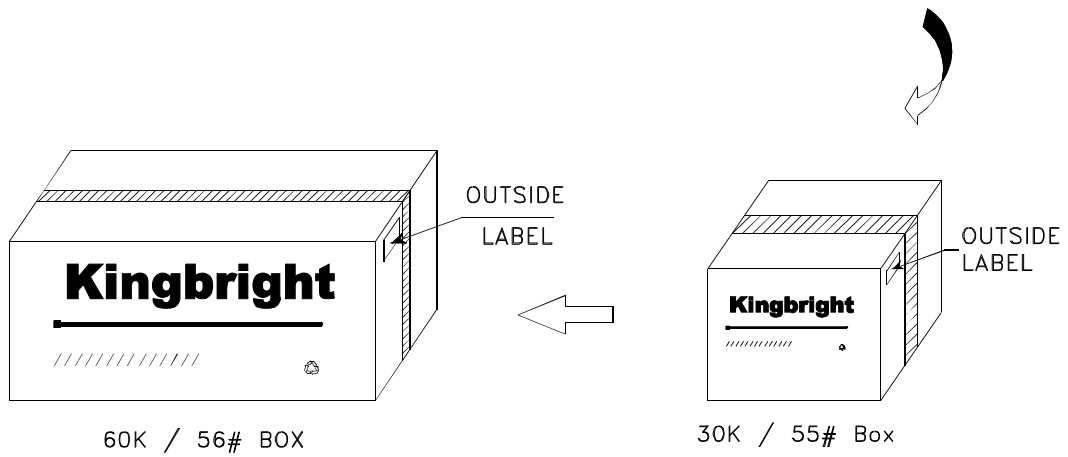
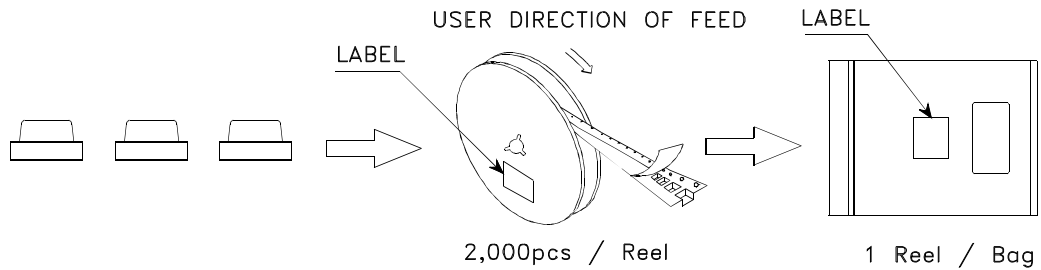

<h2 style="margin: 0;">Kingbright</h2>	
P/NO: APT1608xxx	
QTY: 2,000 pcs	Q.C. Q C XX XX XXXX PASSED
S/N: XXXX	
CODE: XXX	
LOT NO:	
 <small>XXXXXXXXXXXXXXXXXXXXXXXXXXXX</small>	
RoHS Compliant	

Reliability Test Items And Conditions

The reliability of products shall be satisfied with items listed below

Lot Tolerance Percent Defective (LTPD) : 10%

No.	Test Item	Standards	Test Condition	Test Times / Cycles	Number of Damaged
1	Continuous operating test	-	Ta = 25°C ,IF = maximum rated current*	1,000 h	0 / 22
2	High Temp. operating test	EIAJ ED-4701/100(101)	Ta = 100°C IF = maximum rated current*	1,000 h	0 / 22
3	Low Temp. operating test	-	Ta = -40°C, IF = maximum rated current*	1,000 h	0 / 22
4	High temp. storage test	EIAJ ED-4701/100(201)	Ta = maximum rated storage temperature	1,000 h	0 / 22
5	Low temp. storage test	EIAJ ED-4701/100(202)	Ta = -40°C	1,000 h	0 / 22
6	High temp. & humidity storage test	EIAJ ED-4701/100(103)	Ta = 60°C, RH = 90%	1,000 h	0 / 22
7	High temp. & humidity operating test	EIAJ ED-4701/100(102)	Ta = 60°C, RH = 90% IF = maximum rated current*	1,000 h	0 / 22
8	Soldering reliability test	EIAJ ED-4701/100(301)	Moisture soak : 30°C,70% RH, 72h Preheat : 150~180°C(120s max.) Soldering temp : 260°C(10s)	3 times	0 / 18
9	Thermal shock operating test	-	Ta = -40°C(15min) ~ 100°C(15min) IF = derated current at 100°C	1,000 cycles	0 / 22
10	Thermal shock test	-	Ta = -40°C(15min) ~ maximum rated storage temperature(15min)	1,000 cycles	0 / 22
11	Electric Static Discharge (ESD)	EIAJ ED-4701/100(304)	C = 100pF , R2 = 1.5KΩ V = 450V	Once each Polarity	0 / 22
12	Vibration test	-	a = 196m/s ² , f = 100~2KHz , t = 48min for all xyz axes	4 times	0 / 22

* : Refer to forward current vs. derating curve diagram

Failure Criteria

Items	Symbols	Conditions	Failure Criteria
luminous Intensity	Iv	IF = 20mA	Testing Min. Value < Spec.Min.Value x 0.5
Forward Voltage	Vf	IF = 20mA	Testing Max. Value ≥ Spec.Max.Value x 1.2
Reverse Current	IR	VR = Maximum Rated Reverse Voltage	Testing Max. Value ≥ Spec.Max.Value x 2.5
High temp. storage test	-	-	Occurrence of notable decoloration, deformation and cracking