

Arktite heavy duty circuit breaking plugs and receptacles

Industrial heavy duty
Non-hazardous areas

NEMA 4 Watertight

1P

Applications:

Arktite® circuit breaking plugs and receptacles are used:

- To supply power to portable electrically operated devices such as motor generator sets, compressors, heating and cooling units, welders, conveyors, lighting systems and similar equipment
- Where temporary power is needed, such as at trailers, building units, heavy machinery and similar equipment
- Wherever electrical loads must be quickly disconnected from power source
- In a typical installation, where a large machine utilizes a number of electrical motor drives and for ease of adjustment, removal, maintenance and replacement, each motor is connected by portable cord and Arktite receptacles rather than permanently wired
- In areas where dust, dirt, moisture and corrosion are a problem
- Indoors and outdoors in non-hazardous areas of chemical plants, process industry facilities, meat packing plants, manufacturing plants and similar industrial locations

Features:

- Circuit breaking – plugs through 100 ampere rating may be disconnected under load; 150-400 ampere units are for service disconnect use only
- Receptacles accept only plugs of the same amperage rating, style and number of poles, making it impossible to mismatch, and provides for positive polarization
- Extra wide electrical spacing allows for maximum safety
- Insulator materials are the result of intensive testing; selection has been made based on highest dielectric strength, maximum mechanical and impact resistance, lowest moisture absorption and highest arc tracking resistance
- A variety of installations is possible due to the availability of several types of back boxes
- Designed to withstand rough usage and the effects of adverse environments
- Reversible interiors – 30, 60 and 100 ampere (except 30 and 60 ampere, 5-pole); Arktite plug and receptacle interiors are interchangeable using a screwdriver, making it possible to feed a normally de-energized receptacle from an energized plug with usual Arktite safety; no energized contacts are exposed

Certifications and compliances:

- UL standards: 1203^A, 1682, 1686
- CSA standard: C22.2 No. 182.1
- CE (LVD) 2006/95/EEC^B



^A APJ and NPJ plugs only.

^B Excludes 200A and 400A APR connectors.

Arktite heavy duty circuit breaking plugs and receptacles

NEMA 4 Watertight

1P

Industrial heavy duty
Non-hazardous areas

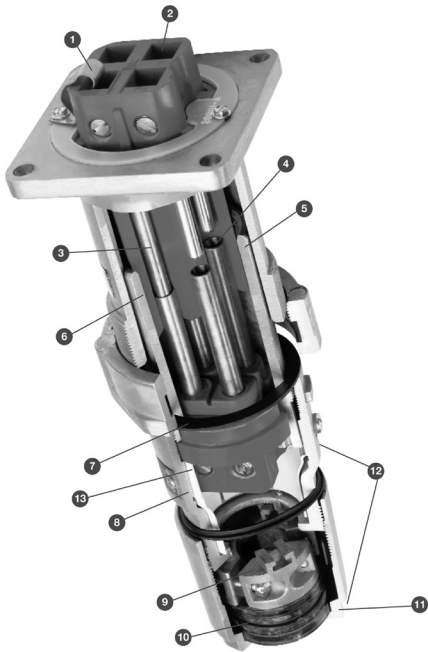

Split pin contact design:

- Provides nearly 360° of contact at every insertion, ensuring protection against heat rise and eliminating arcing on critical surfaces
- Continuous contact over length and circumference of mated pins provides superior safety and long-term performance
- Self-wiping at every insertion to prevent environmental contamination build-up



The additional features below are called out in the illustration on this page:

- 1 The ground contact is bonded to the receptacle housing (Style 2).
- 2 Unimpeded, easy access phase and ground terminals make wire termination quick and easy.
- 3 Grounding contacts that make first and break last in the unlikely event of keyway failure.
- 4 An arc formed when the plug is being removed is instantly snuffed in the deep confined insulated arcing chamber.
- 5 A detent spring forms a parallel grounding path through the metallic plug sleeve and receptacle housing and is the first contact to make and the last to break.
- 6 The plug sleeve is keyed to the receptacle to prevent mispolarization.
- 7 The gasketing system provides unsurpassed watertight integrity (NEMA 4).
- 8 All aluminum Uni-Shell™ construction provides superior strength in abusive environments.
- 9 The Tri-Lock™ cable grip has three-piece design that equally distributes gripping power around perimeter of cable. Cord jacket does not get pinched, eliminating potential for damage to both internal conductors and external cable jacket. Cable grip is located inside plug housing, eliminating corrosion of vital hardware and making plug maintenance easy.
- 10 The unique Sure-Seal™ cable gland has two gasket sizes which fit entire range of cable diameters, reducing risk of improper assembly. The gasket ratchets into the Tri-Lock cable grip to prevent plug from turning or loosening in high vibration areas.
- 11 Wrenching surfaces make Arktite plugs quick and easy to assemble.
- 12 Smooth and contoured design of plug housing eliminates occurrence of cable grip snagging or breaking off. Tri-Lock screws are captive so cable grip cannot come apart during assembly. Prevents critical screws from getting lost during installation.
- 13 Plastic sleeve between insulator body and housing minimizes possibility of electrical shock in event of ground failure. Increases creepage and clearance protection.

Arktite advantage features:

Internal plug safety insulator

- Plastic barrier between insulator body and metal housing minimizes risk of energizing handle body due to stray conductor strands
- Increases creepage and clearance protection

CE marked

- Offers a borderless solution with no additional inspection or documentation required for approval

Lockout plug

- Allows users to comply with OSHA lockout/tagout requirements
- Ensures plug cannot be inserted into receptacle when maintenance is being performed downstream of power supply

Tri-Lock cable grip

- Three-piece design equally distributes grip around perimeter of cable
- Cable jacket does not get pinched, eliminating potential for damage to internal conductors
- Captive screws allow maximum extension of cord grip without risk of loose components

Sure-Seal cable gland

- Two gasket sizes fit entire cable range, reducing risk of improper assembly
- Gasket ratchets into Tri-Lock cable grip to provide environmental protection in high vibration areas



Plug housing

- Smooth design eliminates occurrence of cable grip snagging or breaking off
- Houses Tri-Lock cable grip to eliminate corrosion of vital hardware and increase ease of maintenance

Combination drive stainless steel hardware

- Increases ease of installation by allowing for more than one option for installation tools
- Stainless steel external hardware eliminates corrosion on critical components and extends product life

Insulator assemblies

- Unimpeded, easy access phase and ground terminals make wire termination quick and easy
- Lug screws secured with tape to prevent them from vibrating loose and falling out during shipping

Combination slot and hex mechanical lugs

- Increases ease of installation by allowing for more than one option for installation tools
- Hex head allows for easy achievement of specified torque value

Receptacle cover

- Automatic weatherproof seal every time plug is disengaged
- Field replaceable design allows for new cover to be threaded on quickly and easily

• 60, 100 and 150A offering.



Arktite heavy duty circuit breaking plugs and receptacles

NEMA 4 Watertight

1P

Industrial heavy duty
Non-hazardous areas

Grounding – Style 1 vs. Style 2:

Eaton's Crouse-Hinds series Arktite devices utilize two methods, or styles, for completing the grounding circuit in plugs and receptacles. NEC reference 250.138 (A) and (B).

Style 1 – metallic

A Style 1 plug is one in which the grounding conductor in the flexible cable is bonded to the plug sleeve by a pressure connector. A Style 1 receptacle is one which is grounded by virtue of the fact that it is an integral part of a grounded conduit system. On insertion, the plug sleeve makes contact with detent springs of the grounded receptacle housing before line and load poles engage, and on withdrawal, remains in contact until after line and load poles disengage. Therefore, exposed metal parts of the portable equipment or plug are suitably grounded.

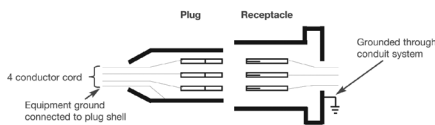
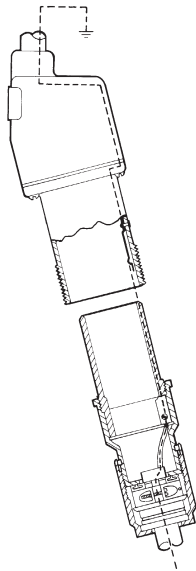

Style 1
ground conductor
attaches to shell

Style 2 – metallic

A Style 2 metallic housing plug is one in which the grounding conductor in the flexible cable is bonded to the extra (grounding) pole and metal plug sleeve by a pressure connector. A Style 2 metallic housing receptacle is one in which the extra (grounding) pole is electrically connected to the equipment grounding conductor and the metal receptacle housing which itself is grounded by virtue of the fact that it is an integral part of a grounded conduit system. In Style 2 non-metallic housing plugs and receptacles, the extra pole is used for grounding since the housings are non-conductive.

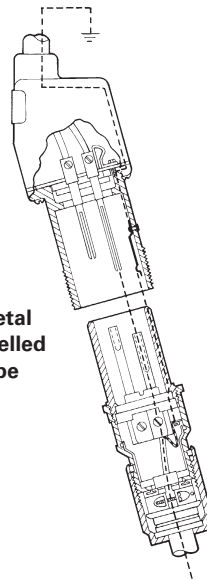

Metal shelled type

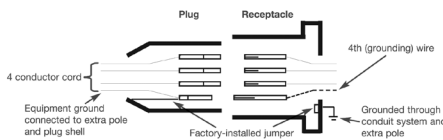

Style 2
ground conductor
attaches to contact,
which is bonded to
shell

Style 2 – non-metallic

In a Style 2 receptacle, the grounding connection is made before line and load poles engage, and is broken after the line load poles disengage. Furthermore, upon insertion, the plug sleeve of metal shelled units makes contact with detent springs of the grounded receptacle housing before line and load poles engage, and on withdrawal, remains in contact until after line and load poles disengage. Therefore, exposed metal parts of the portable equipment or plug are suitably grounded.

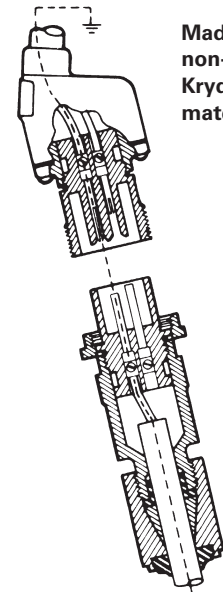

Made of non-metallic Krydon material

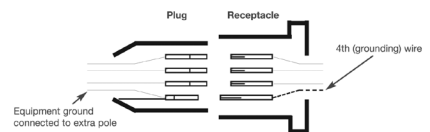

1P

Arktite heavy duty circuit breaking plugs and receptacles

NEMA 4 Watertight

1P

Industrial heavy duty
Non-hazardous areas

Standard materials:

- Metallic receptacle housings, plug and cord connector bodies – high impact strength copper-free aluminum
- Non-metallic receptacles, plugs and cord connectors – Krydon fiberglass-reinforced polyester
- Back boxes (20, 30, 60, 100, 150, 200 amperes) – cast aluminum; 400 amperes – Feraloy iron alloy
- Insulation (metallic products) (2-, 3-, 4-pole) 30, 60, 100, 200, 400 amperes – fiberglass-reinforced polyester; 20, 30 amperes (5-pole) – melamine
- Contacts: pressure, solder, binding screw – brass; crimp/solder 20, 30, 60, 100 amperes – leaded red brass; crimp/solder 150, 200, 400 amperes – tellurium copper

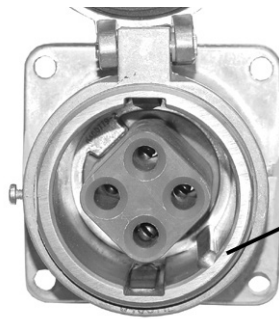

Arktite receptacles have a cast raised rib located inside the receptacle sleeve. The location of the rib is in a specific relationship to the receptacle insulator that houses the contacts.

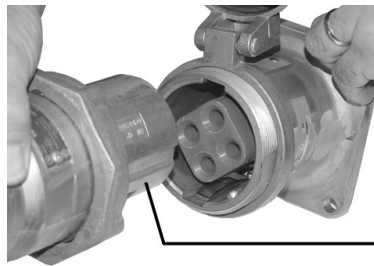

The mating plug has a cast groove located on the outside of the plug sleeve. This groove lines up with the raised rib.

Standard finishes:

- Feraloy – electrogalvanized and aluminum acrylic paint
- Aluminum – natural
- Krydon fiberglass-reinforced polyester – gray
- Fiberglass-reinforced polyester insulation – (red)
- Melamine – natural (brown)
- Brass – natural
- Leaded red brass – electro-tin-plate

Accessories:

- Accessories include a variety of angle adapters, panel adapters and back boxes for Arktite receptacles (see pages 1332-1335)
- Included throughout Section 1P are wire mesh cable grips and protective caps for Arktite plugs

Options:

- | Description | Suffix |
|---|-------------|
| • Reverse service..... | S22 |
| <i>Receptacle assembled with plug interior (exposed contacts); plug assembled with receptacle interior (recessed contacts)</i> | |
| <i>For applications where plug is energized to feed normally de-energized receptacle</i> | |
| <i>Available on 30A-400A units</i> | |
| • Special polarity..... | S4 |
| <i>Receptacle interior rotated 22½° to right and plug changed to match (see photo at right)</i> | |
| <i>For use where two or more receptacles of the same ampere rating, style and number of poles are to be installed in the same area for use on different voltages and/or frequencies</i> | |
| <i>Prevents insertion of a plug in a receptacle with different electrical rating</i> | |
| <i>Available on 20A-400A units</i> | |
| • Corro-free epoxy powder finish for added corrosion resistance..... | S752 |
| <i>Available on 20A-400A units</i> | |

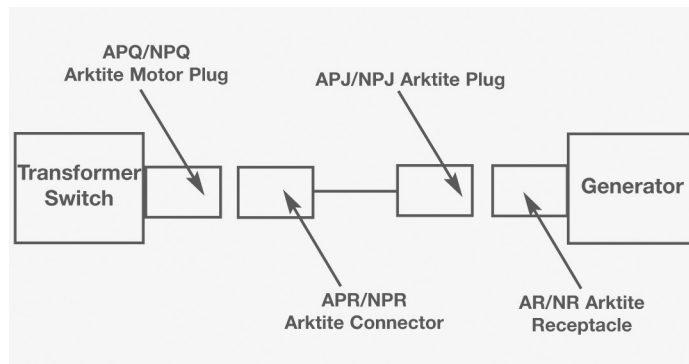

Typical installation

Ⓧ 150A, 200A and 400A rated units are for service disconnect use only.

1P

Arktite heavy duty circuit breaking[®] plugs and receptacles

NEMA 4 Watertight

1P

Industrial heavy duty
Non-hazardous areas

Horsepower ratings: Locked rotor interrupting

Amperage plug and receptacle	Motor horsepower [Ⓕ]			
	120V	240V	480V	600V
Single-phase electrical system				
30	2	3	7.5	10
60	5	10	25	20
100	10	20		
200	15	40		
Three-phase electrical system				
30	3	5	10	10
60	10	20	40	50
100	15	30	40	25
200	30	60	25	15

Maximum horsepower for plug and receptacle combinations by input voltage[Ⓖ]:

The following values are typical horsepower ratings based on NEC Article 430 tables. HP ratings are based on the largest conductor size for each plug and receptacle combination per the wire size table below.

Amperage plug and receptacle	Motor horsepower [Ⓖ]		
	240V	480V	600V
30	15	30	40
60	20	40	50
100	30	60	75
150	40	75	100
200	60	125	150

Wire sizes:

The table below lists the diameter of the wire recess in Arktite plug and receptacle contacts so that maximum size of bare conductor can be figured. Range of wire sizes shown in table is intended only as a guide. Depending on type of wire used (building wire, flexible or extra flexible cable) and its construction (number and size of strands), bare copper diameters vary widely.

Diameter of wire recess in plug and receptacle contacts:

Amperage	Contact type	Diameter of recess	Wire size [Ⓘ]	
			Building	Extra flex
20	Binding screw	N/A	#14 - #12	#14 - #12
30 (2-, 3-, 4-pole)	Pressure	0.281	#10 - #6	#10 - #8
30 (2-, 3-, 4-pole)	Crimp/solder	0.180	#10 - #8 [Ⓢ]	#10 - #8
30 (5-pole)	Solder	0.188	#12 - #6	#12 - #8
60 (2-, 3-, 4-, 5-pole)	Pressure	0.312	#6 - #4	#8 - #4
60 (3-, 4-pole)	Crimp/solder	0.277	#6 - #4 [Ⓢ]	#8 - #4
100 (2-, 3-, 4-pole)	Pressure	0.390	#4 - #1	#4 - #2
100 (3-, 4-pole)	Crimp/solder	0.390	#2 - #1 [Ⓢ]	#2 - #2
150 (4-pole)	Pressure	0.390	#2 - 2/0	#2 - 1/0
200 (3-, 4-pole)	Pressure	0.687	2/0 - 4/0	2/0 - 3/0
200 (Std. 3-, 4-pole)	Crimp/solder	0.560	#1 - 4/0	#1 - 3/0
200 (Lq. 3-, 4-pole)	Crimp/solder	0.750	4/0 - 250MCM	3/0 - 250MCM
400 (Std. 3-, 4-pole)	Crimp/solder	0.840	250 - 500MCM	250 - 400MCM
400 (Lq. 3-, 4-pole)	Crimp/solder	1.250	500 - 1000MCM	400 - 750MCM

[Ⓔ] 150A, 200A and 400A rated units are for service disconnect use only.

[Ⓕ] Horsepower ratings are based on Eaton's Crouse-Hinds Division testing in which locked rotor currents were interrupted by withdrawing the plug from the receptacle. It is highly recommended, however, that such use be limited to emergency conditions only, and that a horsepower rated switch be used for motor disconnect.

[Ⓖ] This guide is for reference only. Consult your local electrical codes before installation.

[Ⓖ] Eaton's Crouse-Hinds Division does not recommend our plug and receptacle be used for disconnect under load.

[Ⓢ] Do not use wire size smaller than minimum size recommended.

[Ⓢ] Smaller sizes may be used with well reducers - information available upon request.

Arktite heavy duty circuit breaking receptacle assemblies and housings

NEMA 4 Watertight

1P

100A and 150A, 600 VAC/250 VDC, 50-400 Hz

Ordering information:



Receptacle assembly

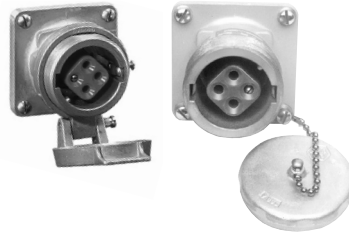

Receptacle



Mating plug



Mating connector

Receptacle assemblies			Receptacle housings only		Mating plugs		Mating connectors
Description	Hub size	Cat. # Spring door	Cat. # Spring door	Cat. # Threaded cap only	Cable dia.	Cat. #	Cat. #
100A - Style 1							
4-wire, 4-pole	1 1/2"	AREA10415	AR1041	AR1047	0.875 - 1.70"	APJ10477	APR10457
	2"	AREA10416					
100A - Style 2							
3-wire, 4-pole	1 1/2"	AREA10425	AR1042	AR1048	0.875 - 1.70"	APJ10487	APR10467
	2"	AREA10426					
150A - Style 2							
3-wire, 4-pole	-	N/A	AR1542	AR1548	0.875 - 1.70"	APJ15487	N/A

For applicable 100A and 150A back boxes, see page 1333.

Dimensions (in inches):

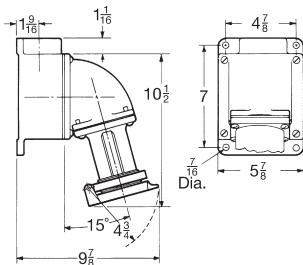

ARE assembly

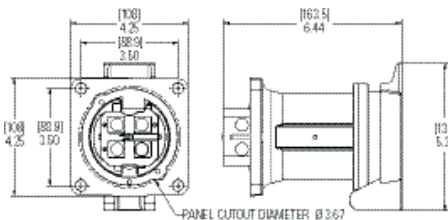

AR receptacle - spring door

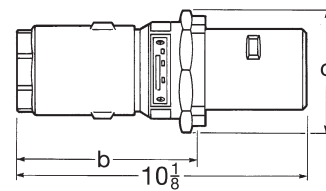

APJ plug

No. of poles	b	c
4	6 7/8	4 1/8

No. of poles	Housing	c
4	Open	3 7/16
4	With cap	3 7/8

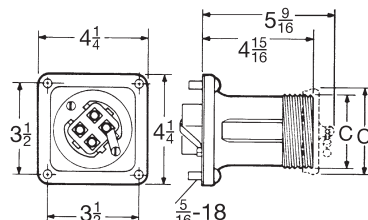

AR receptacle - open and with cap

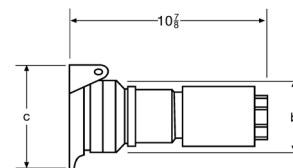

APR connector

No. of poles	b	c
4	3 1/2	3 7/16

^AFor use on systems less than 60 Hz, the receptacles, plugs and connectors are for disconnect use only.

Arktite heavy duty circuit breaking receptacle assemblies and housings

NEMA 4 Watertight

1P

100A and 150A, 600 VAC/250 VDC, 50[Ⓟ]-400 Hz

CPK plug closure caps

Applications:

CPK caps for Arktite plugs are used:

- Where portable equipment is on a standby basis and plugs are not in use
- To effectively protect insulation and contacts from excessive moisture, dirt, dust and corrosion
- With 30, 60, 100, 150 and 200 ampere plugs with fastening ring and standard 200 ampere plugs for the clamp door housing



Ordering information:

Configuration	Cat. #
2P, 3P	CPK62
4P	CPK64

Standard material:

- Copper-free aluminum

Standard finish:

- Natural

Replacement parts:

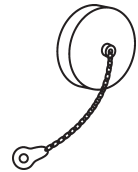
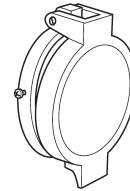
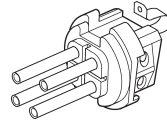
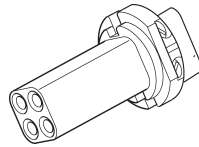

Configuration	Cat. # Receptacle interior	Cat. # Plug interior	Cat. # Spring door	Cat. # Screw cap
2W, 2P	ATP315	ATP310		
2W, 3P	ATP318	ATP313	QE53	QE62
3W, 3P	ATP316	ATP311		
3W, 4P	ATP319	ATP314	QE54	QE64
4W, 4P	ATP317	ATP312		

Replacement pin and sleeve contacts:

Description	Cat. # Receptacle	Cat. # Plug
Available as a kit only; 5 phase contacts and 1 ground contact included	AR100CONKIT	AP100CONKIT

[Ⓟ]For use on systems less than 60 Hz, the receptacles, plugs and connectors are for disconnect use only.