

SERIES AM/S Circuit Breakers

product bulletin



UL 489 Listed to 10 KAIC

International Approvals

UL/CSA Recognized

Ratings from .02 to 100
Amperes

DC Ratings at 80 VDC

AC Ratings at 480 VAC

Hydraulic-Magnetic
Technology

EATON

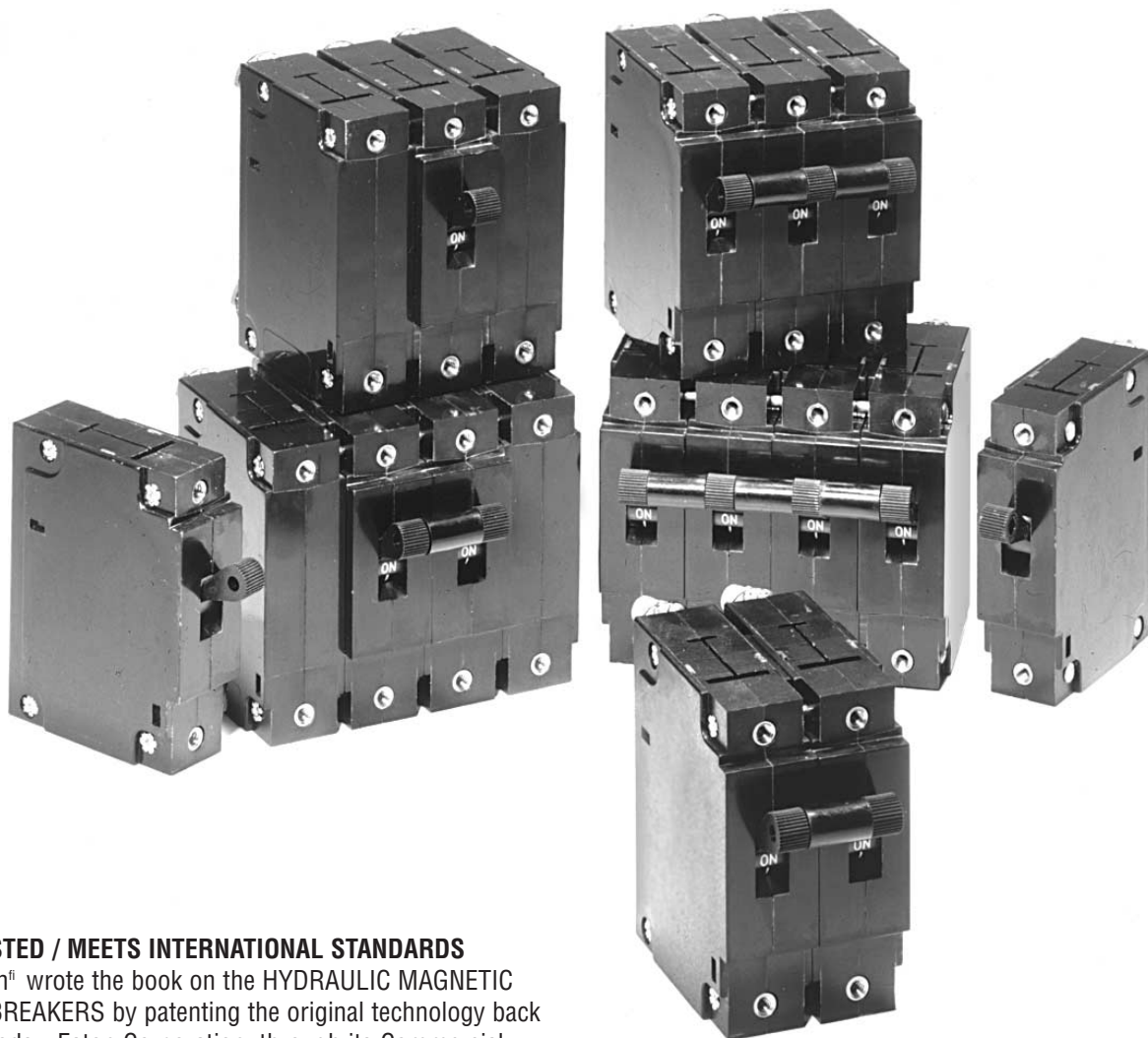

UL489 LISTED / MEETS INTERNATIONAL STANDARDS

Heinemann[®] wrote the book on the HYDRAULIC MAGNETIC CIRCUIT BREAKERS by patenting the original technology back in 1932. Today, Eaton Corporation, through its Commercial Controls Division/Heinemann[®] Products, continues the tradition of technical leadership by introducing the latest innovation in the evolution of the hydraulic magnetic circuit breaker, the rugged and versatile NEW AM/S Series.

The NEW AM/S is designed to be a World Product and solve the toughest equipment circuit protection problems around the globe. It combines the proven high quality and reliability of the current AM Series with the spacing, dielectric and interrupt requirements of International Standards such as EN60947. The NEW AM/S is UL489 Listed as a branch circuit breaker, UL1077 Recognized for appliance protection and CSA Certified for industrial controls. Available in a wide variety of configurations, the NEW AM/S is rated as high as 100A @ 250V ac or 80V dc. It is the solution for demanding dc applications requiring 10k amps interrupting capacity. Of course, the NEW AM/S is ambient temperature insensitive.

FEATURES: NEW AM/S SERIES

- Current range up to 100A 50/60Hz, 60A 400Hz, 100A dc
- Available with ac/dc rating
- Available in one-, two-, three-, and four-pole models
- Common trip on multipole breakers
- UL and CSA Recognition and UL Listing
- International Standards approvals
- MIL-STD approvals for shock, vibration, humidity and moisture
- Ignition protected
- Tamper-proof terminals
- Mid-trip alarm
- Handles knurled for positive grip
- Custom marked handles and colors
- Replacement for all previous AM and AM/S models

Heinemann^{fi} Circuit Breakers Series AM/S

General Specifications

International Specifications. Series AM/S breakers are designed to meet the requirements of IEC-380, IEC-435, IEC-601, VDE-7030, IEC-0750, VDE-0804, VDE-0806, VDE-0660.

Environmental Data. Designed to meet MIL-C-55629 as specified below.

Fungus- and Moisture-Resistance is provided by treating all ferrous parts with a special moisture-resistant finish and by using special springs and inherently fungus-resistant cases, covers and handles. Tested for moisture-resistance per MIL-STD-202, Method 106; tested for salt-spray resistance per MIL-STD-202, Method 101.

Humidity. Tested in accordance with MIL-STD-202, Method 103, test condition A.

Shock and Vibration. Tested for shock in accordance with MIL-STD-202, Method 213, test condition I (100 Gs at 6 milli-seconds). Tested for vibration in accordance with MIL-STD-202, Method 204: 10 to 500 Hz, 0.06" total excursion on three mutually perpendicular planes. Shock and vibration tests are conducted with breakers carrying full rated current. Shock and vibration specifications apply to time-delay breakers only.

Operating Temperature. -40 C to +85 C.

Dielectric Strength. Tested in accordance with MIL-STD-202, Method 301; 1500V at 50/60 or 400 Hz, 1100V dc (or twice rating plus 1000V).

Meets 8mm international spacing and 3750V 50/60 Hz dielectric requirements from hazardous voltage to operator accessible surfaces, between adjacent poles and from main circuit to auxiliary circuit.

Insulation Resistance. 100 Megaohms minimum at 500V dc, per MIL-STD-202, Method 302.

Endurance. Breakers are subjected to an endurance test consisting of 10,000 on/off operations; 6000 at rated current and voltage, 4000 at no load.

Flammability Specifications:

UL 94-V0

UL 94-HB

Approximate Weights. AM1S, 3 oz; AM2S, 6.5 oz; AM3S, 9.5 oz; AM4S, 12.5 oz.

AM/S AGENCY APPROVALS							
Circuit Configuration	Voltage			Rated Current	Interrupting Capacity, Amps ^⑨		
	Max. Rating	Frequency ^②	Phase		UL 1077 CSA	VDE 0660 PENDING	UL 489 Listed
Series	65	DC	1	.1 - 100	7500 ^①	N/A	7000 ^⑩
	80	DC	1	.1 - 70	7500 ^①	5000 ^⑥	10000 ^①
	80	DC	1	70.1 - 100	7500 ^①	1500 ^⑦	10000 ^①
	120	50/60	1	.1 - 50	---	---	5000 ^①
	120/240	50/60	1	.1 - 50	---	---	5000 ^①
	120	50/60	1	.1 - 20	---	---	10000 ^①
	125/250	50/60	1	.02 - 100	3000 ^①	---	---
	250	50/60	1 & 3	.02 - 100	5000 ^③	⑧	---
	80/250	50/60/DC	1 & 3	.02 - 100	5000 ^③	---	---
	240/415	50/60	3	.1 - 50	5000 ^④	⑤	---
	277/480	50/60	3	.1 - 30	3000 ^④	⑤	---
	277	50/60	1	.1 - 50	5000 ^③	---	---
250	50/60	1 & 3	.1 - 50	1500 ^①	---	---	
Switch Only Per UL 508	80	DC	---	.02 - 100	N/A	N/A	N/A
	415	50/60	3	.02 - 50	N/A	N/A	N/A
	250	50/60	1 & 3	.02 - 100	N/A	N/A	N/A
	277	50/60	1	.02 - 50	N/A	N/A	N/A
	277/480	50/60	1 & 3	.02 - 30	N/A	N/A	N/A
Marine Ignition UL 1500	250	50/60	1	.1 - 75	2000 ^③	---	---
	65	DC	---	.1 - 60	2000 ^③	---	---
	250/65	50/60/DC	1 & 3	.1 - 60	2000 ^③	---	---

① Units do not require backup (series) fusing.

② DC and 1 Phase 277V max ratings are 1 or 2 pole breaking. 3 phase ratings are 3 pole breaking.

③ Requires branch circuit backup with UL Listed Type K5 fuse rated (15A minimum) at no more than 175A for 51 thru 100A rating.

④ UL Recognized/CSA Certified. Refers to 3 and 4 pole versions used only in a 3 phase, WYE connection with series fusing as stated in note ③.

⑤ VDE Certification at 400 volts.

⑥ P1 Rating.

⑦ P2 Rating.

⑧ Consult Factory for availability.

⑨ A clearance of 1 inch for dc and 2 inches for ac is required between the arc vent and conductive surfaces or components.

⑩ Fuse clip construction.

Heinemann® Circuit Breakers Series AM/S

Precise overload protection — with Heinemann® Hydraulic-Magnetic circuit breakers

Heat-induced nuisance tripping eliminated

Heinemann® hydraulic-magnetic circuit breakers offer three major advantages over thermal devices:

1. Elimination of nuisance tripping caused by high ambient temperature in or near the installation. The breaker responds only to current variations, not to temperature change.
2. Assurance that 100% of the rated current will be carried. There is no such assurance with thermal devices, which may fail to carry rated current when subjected to above-normal ambient temperatures. A Heinemann® breaker rated at 20 A, for example, will sustain 20 A, even at elevated temperatures. Derating and other forms of temperature compensation are unnecessary.
3. Immediate reset. Since there are no thermal elements, heat build-up is not a factor. Therefore, no “cooling off” period is required after fault interruption.

Time delay eliminates breaker tripping due to transient current surges

Elimination of transient current surges as a cause of nuisance tripping is accomplished through the creation of a controlled time delay. In any installation where a power supply or compressor motor is on the line, an inrush of current occurs

when the equipment is first turned on. The bigger the equipment, the larger the surge. Although inrush surges are, in fact, transient overloads, they usually pose no threat of damage to the line or to the equipment. So, it is not necessary or even desirable to interrupt the power when they occur.

The hydraulically-controlled time-delay mechanism of a Heinemann® breaker eliminates nuisance tripping without lessening overload protection. The delay is inversely proportional to the overload; response is quicker on large overloads, where greater potential danger exists, and slower on small overloads. Except in special high-inrush models, heavy overload and short-circuit currents of greater than 10 times the breaker’s rating provide instantaneous response. (An instantaneous-trip breaker is available for use on, for example, modern medical and communication equipment, which cannot tolerate even brief overloads.)

For added protection, the time-delay is self-adjusting to ambient temperature conditions. At high ambients, where the overload tolerance of most circuits is lowered, the viscosity of the special fluid in the breaker’s dashpot is lessened, and the time-delay response is correspondingly longer to allow cold-equipment startups.

The Hydraulic-Magnetic principle

How the breaker works

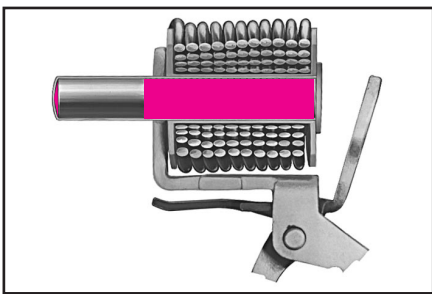

1. The Heinemann® hydraulic-magnetic circuit breaker operates on load-current-produced magnetic-flux variations in a solenoid. The coil is wound around a hermetically-sealed, non-magnetic tube containing a spring-loaded, movable iron core in a special-liquid fill. With the load current either at or below the breaker’s nominal rating, the magnetic flux is of insufficient strength to move the core, so it remains at the end of the tube opposite the armature.

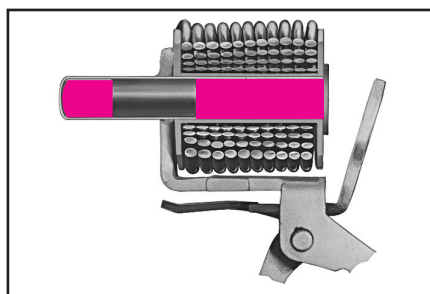

2. With excessive current, the magnetic flux force increases, pulling the iron core toward the armature end of the tube. This core insertion reduces the reluctance of the magnetic circuit and further increases the strength of the magnetic field. The special liquid regulates the core’s speed of travel, creating a controlled trip delay that is inversely proportional to the magnitude of the overload. If the overload subsides before the core reaches the pole piece, the core returns to its original position, and the breaker does not trip. (For non-delay applications, the breaker is modified to omit the intentional delay.)

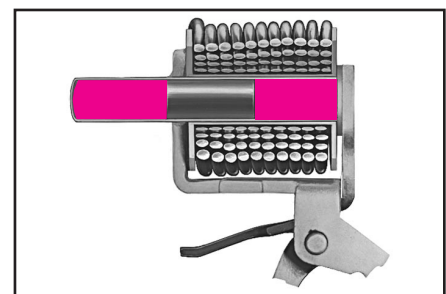

3. When the magnetic flux reaches a predetermined value, the armature is attracted to the pole piece and the breaker trips. (The breaker may trip before the core reaches the pole piece if the critical flux value is achieved first.) On very heavy overloads or short circuits, the flux produced by the coil alone, regardless of core position, is sufficient to pull in the armature. This circuit interruption occurs with no intentional delay — a highly desirable response characteristic.

Heinemann[®] Circuit Breakers Series AM/S

Tripping Specifications

Breakers (in standard wall-mounted position) shall hold 100% rated current. For table and ceiling mount consult factory.

60 Hz or DC

Breakers may trip between 101% and 125% rated load; must trip at 125% rated load and above, as shown on time-delay curve selected.

AC/DC

Breakers may trip between 101% and 135% rated load; must trip at 135% rated load and above.

400 Hz

Breakers may trip between 101% and 150%, must trip at 150% and above.

Non-Time Delay Trip Ranges

Breakers that have no deliberately imposed delay (less than 100ms) are specified as follows.

Breakers shall hold 100% rated current.

Breakers for 50/60 Hz or dc service may trip between 101% and 125% rated current, must trip at 125% rated current and above.

Breakers for 400 Hz service may trip between 101% and 150% rated current, must trip at 150% rated current and above.

Note: All the curves shown describe breaker response with no pre-loading. (Breakers do not carry current prior to application of overload for calibration testing.) Curves are plotted at an ambient temperature of 77 F (25 C), with breakers in the standard wall-mounted position.

Time Delay Curve Selection

1. Determine required frequency.
2. Determine required high inrush tolerance (tolerance to starting surges caused by high-resistance loads such as ferro-resonant power supplies which may last up to 8 milliseconds). Select lowest high inrush tolerance compatible with application.
3. Determine required curve characteristics based on application:

Long Time Delay Curve Motor starting, locked rotor tolerance, general purpose applications.

Medium Time Delay Curve Transformer protection, capacitor loads, special incandescent lamp loads, general purpose applications (**most widely used curve**).

Short Time Delay Curve Electronic equipment.

Instantaneous Curve (no deliberate time delay provided) Unusual circumstances in electronic equipment and other special applications.

Frequency			High-Inrush Tolerance ①			Curve Characteristics				Curve No.		
50/60 Hz	400 Hz	DC	AC/DC	8X	18X	25X	Inertia Wheel	Long	Medium	Short	Inst.	
*	*	*	*	*				*				1
*	*	*	*	*					*			2
*	*	*	*	*						*		3
*	*	*	*	*	*			*				10
*	*	*	*	*	*				*			20
*	*	*	*	*	*					*		30
*	*	*	*	*		*		*				251
*	*	*	*	*		*			*			252
*	*	*	*	*		*				*		253
*	*	*	*	*							*	P

① Multiples of Breaker Must Hold Rating.

Resistance and Impedance Values

Tolerance Limits

Current (amps)	Tolerance (%)
0.1 to 19.9	-25
20 to 100	-35

Nominal DCR and impedance				60 Hz Delays (Impedance in Ohms)			400 Hz Delays (Impedance in Ohms)		
DC Delays (Resistance in Ohms)				Curves			Curves		
Current Rating	P-2-3	251-252-253	DuCon 2-3-20-30	P-2-3	251-252-253	DuCon 2-3-20-30	P-1-2-3	251-252-253	DuCon 2-3-20-30
0.05	447	730	730	418	836	809			744
0.10	127	182	174	139	176	186			200
0.5	4.12	7.0	6.4	3.99	7.3	6.4			9.36
1	.86	1.65	1.67	.917	1.580	1.780			1.74
5	.050	.069	.069	.051	.073	.068			.074
10	.014	.0181	.0177	.016	.0172	.0158			.021
15	.0059	.0164	.0146	.0060	.0162	.0155			.0101
20	.0045	.0068	.0067	.0046	.0067	.0068			.0060
30	.0031	.0028	.0019	.0031	.0031	.0029			.0037
50	.0017	.0020	.0019	.0017	.0020	.0019			.0024
70	.0007			.0007					
100	.0006			.0006					

DCR and impedance based on 100% rated current applied and stabilized a minimum of one hour. Tolerance 0.02 amps to 2.5 amps -20%, 2.6 amps to 20 amps -25% 21 amps to 100 amps -50%.

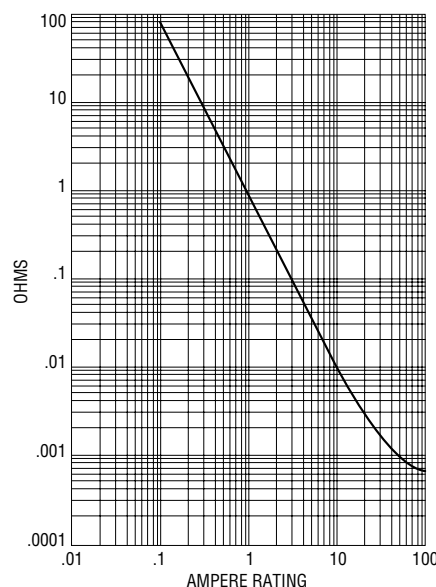

Heinemann® Circuit Breakers Series AM/S

How to order Series AM/S circuit breakers*

* Non-Standard part numbers may require a factory assigned part number.

AM2S- Step 1 A2A3- Step 2a & b L Step 3 AA- Step 4 02J- Step 5a & b H- Step 6 A- Step 7 52- Step 8 PN- Step 9 30- Step 10 02 Step 11

Step 1 — AM2S-

Series prefix (AM) and number of poles (1-4) followed by an S. Series MM/S (UL 1500 Marine Ignition Protection).

Step 2a — A2A3-

Voltage, frequency and internal circuit for first pole on left as viewed from front of panel, or for all poles if identical, from Tables A and B.

Table A

Code	Frequency	Terminal Location	Maximum Voltage
A	60 Hz	Back	250/400
A	60 Hz	Back	480
A	60 Hz	Back	415
B	dc (Note 5)	Back	80
C	400 Hz	Back	250
D	60 Hz/DC	Back	250 AC/ 80 DC

Table B

Inrush Code	Internal Circuit Construction	VDE	UL/CSA	489
- Std. 18x 25x				
0	Switch (no overload coil)	Yes	Yes	No
2 9 39④	Series trip with SPDT aux. switch	Yes	Yes	Yes
3 8 38④	Series trip	Yes	Yes	Yes
5	Shunt/Tap ①	Yes	Yes	No
6	Relay-trip ②	No	Yes	No
15④25④	Du-Con with Shunt/Tap voltage coil ① ③	Yes	Yes	No
16④26④	Du-Con with relay-trip voltage coil ② ③	No	Yes	No

① Voltage rated shunt/tap coils provide tripping on line voltage.

② Relay trip constructions do not meet spacing requirements for World Market Applications. Consult factory for construction alternatives. Consult factory for other internal circuits that are available.

③ Du-Con voltage coils require 30 VA minimum power to trip instantaneously.

④ 40 Amp max.

Notes:

1. Specify voltage-rated coils separately. Example: Catalog Number AM1-A5. Voltage coil, intermittent-duty, trips on 250V, 50/60 Hz ac, Curve P. **2. Relay-trip poles.** Always specify load values for coil and contacts separately. Example: Catalog Number AM1-B6. Coil: 5 amp, 60V dc. Curve 3; contacts: 10 amp, 250V 50/60 Hz. **3. UL/CSA models** are labeled with the UL/CSA-recognized voltage (page 3). The catalog number of the breaker label will contain a special suffix indicating UL/CSA recognition. See Table E. **4.** If voltage is rectifier-produced dc, furnish separately: (a) Full- or half-wave rectification, (b) Number of phases, (c) Filtered or unfiltered. If filtered, give ripple factor or percent filter factor.

Step 2b — A2A3-

Repeat Step 2 for second and third poles and subsequent poles if different from first. Repeat aux. switch codes when more than one switch is specified (ex. AM2S-A2A2).

Step 3 Table C — L

Number of handles and handle position from Table C.

A – Single pole unit.

B – Two pole unit. Handle on left pole only.

D – Three pole unit. Handle on center pole only.

L – Handle on each pole.

R – Four pole unit. Handle on left center and right center poles only.

Other configurations available; consult factory.

Step 4 Table D — AA-

Handle color and marking from Table D.

	On/Off ⑤	I/O ⑤	Combined I/O – On/Off
Black	A	I	**AA
White	B	J	BB
Red	D	L	DD
Yellow	F	N	FF
Green	E	M	EE
Orange	H	P	KK

Other colors available; consult factory.

⑤ Standard Color for Marking is White except black is used on white.

** Standard

Step 5a — 02

Mounting information:

02	6-32 THD
05	M3-0.5 THD

Step 5b — J-

C	10-32 THD screws standard to 50A
F	M5 THD screws standard to 50A
J	10-32 THD stud standard to 70A (VDE to 50A)
K	/-20 THD stud standard over 70A (VDE over 50A)
L	M5 THD stud standard to 70A (VDE to 50A)
M	M6 THD stud standard over 70A (VDE over 50A)
N	Fuse clip terminals
R	Plug in terminals

Step 6 — H- or D-

VDE approved (H). Available as shown in Table B.
 (H) voltage — 400V ac (VDE) 50/60 Hz, 80V dc (VDE pending)
 or 240V ac — 400 Hz.
 (D) domestic — no VDE label.

Step 7 Table E — A-

Suffix Code, if for UL application, from Table E.
Suffix Code for UL Applications
 A – 250V ac, 50/60 Hz; 65V dc; 250V, 400 Hz, 80V dc
 L – 277V ac, 50/60 Hz
 AD – 415V ac, 50/60 Hz (50 Amp max.)
 NU – Non-UL Recognized – call factory
 AB – 480V ac, 50/60 Hz (30 Amp max.)
 DU – UL listed to UL 489 120V ac, 50/60 Hz; 80V dc
 See page 3 for UL approved ratings.
 Consult factory for additional UL codes.

Step 8 Table F — 52-

Auxiliary switch information from Table F.
 52 – SPDT 10 Amp .110 Quick Connect Terminals (Std.)
 54 – SPDT 0.1 Amp .110 Quick Connect Terminals
 07 – SPDT 10 Amp .187 Quick Connect Terminals ©
 Other auxiliary switches available; consult factory.
 © Not VDE approved.

Step 9 — PN-

Customer part number to be marked on breaker.

Step 10 Table G — 30-

Current rating in amperes.
Standard Ampere Ratings

0.10	2.5	20	50
0.25	5	25	60
0.50	7.5	30	70
0.75	10	35	100
1	15	40	

Other non-listed ratings are available.
 Consult factory for availability and lead times.
 Current rating will be identified on breaker label but may not be shown in product description.

Step 11 Table H — 02

Time Delay Curves

Code	Inrush Codes ⑦			
	Std.	18x	25x	
-SW				(Switch Only)
-0P	X			
-01	X			
-02	X			
-03	X			
-10		X		
-20		X		
-30		X		
251			X	
252			X	
253			X	

See time delay curves on pages 8-10 for required delay.

⑦ Inrush values based on 60 Hz.

Time delay curve will be identified on breaker label but may not be shown in product description.

Note: The new series AM/S is form, fit and function interchangeable with the Series “AM” and/or Series “AM/S” product. Incoming requirements and orders for product carrying a special catalog number in either the “AM” or “AM/S” will be produced as a new AM/S and will be identified with the existing special catalog number.

AM/S Time Delay Chart Percent of Rated Current Versus/Seconds Delay

INRUSH	Delay	100%	125%	135%	150%	200%	300%	400%	500%	600%	700%	800%	900%	1000%	1100%	1200%
50/60 Hz 8x	1	No Trip	50-700	---	32-350	10-90	---	1.50-15	---	.5-7	---	.02-3	---	.006-2	---	.005-1
	2	No Trip	10-110	---	4.5-50	1.7-18	.55-6.0	.25-2.8	.11-1.9	.05-1.5	.025-1.2	.015-.80	.011-.41	.01-20	.009-10	.008-.05
	3	No Trip	1-12	---	.40-5.0	.15-1.9	.054-.64	.03-.30	.017-.20	.01-.14	.007-.09	.005-.06	.004-.05	.004-.05	.004-.046	.004-.04
50/60 Hz 18x	10	No Trip	60-700	---	30-350	10-120	3.4-42	2.0-22	1.1-12.5	.50-8.0	.17-5.2	.05-4.0	.02-3.4	.01-3.0	.008-2.5	.008-2.0
	20	No Trip	10-110	---	4.5-50	1.7-18	.54-6.9	.30-4.0	.18-2.75	.10-2.0	.04-1.4	.02-1.0	.013-.75	.01-50	.01-25	.01-10
	30	No Trip	1.0-12	---	.40-5.0	.15-1.9	.052-.73	.03-.40	.02-.27	.015-.20	.012-.14	.01-10	.008-.074	.006-.06	.005-.053	.005-.05
50/60 Hz 25x	251	No Trip	75-400	---	35-170	15-70	5.0-25	3.0-15	2.0-9.5	1.5-8	.9-7	.5-6	.4-5	.3-5	.2-5	.1-4
	252	No Trip	10-100	---	6-55	2.5-20	.85-4.5	.45-2.5	.30-1.8	.22-1.6	.15-1.5	.10-1.4	.08-1.2	.07-1.0	.06-90	.05-70
	253	No Trip	1-17	---	.40-4.5	.16-1.6	.06-.46	.05-.40	.04-.35	.03-.30	.025-.25	.020-.22	.015-.20	.012-.15	.009-.12	.008-.08
DC 8x	1	No Trip	45-345	---	20-150	9-60	3-20	1.4-11.4	.45-7.5	.15-5.8	.03-4.5	.009-3.7	.006-2.6	.005-1.7	.005-.90	.005-.50
	2	No Trip	6.0-80	---	2.5-30	.80-10	.25-3.7	.15-2.0	.09-1.2	.05-.80	.021-.50	.01-30	.006-.17	.005-.10	.004-.06	.004-.04
	3	No Trip	1.0-12	---	.40-5.0	.15-1.9	.054-.64	.03-.30	.017-.20	.01-.14	.007-.09	.005-.06	.004-.052	.004-.05	.004-.046	.004-.04
DC 18x	10	No Trip	60-700	---	30-350	10-120	3.4-42	2.0-22	1.1-12.5	.50-8.0	.17-5.2	.05-4.0	.02-3.4	.01-3.0	.008-2.5	.008-2.0
	20	No Trip	10-110	---	4.5-50	1.7-18	.54-6.9	.30-4.0	.18-2.75	.10-2.0	.04-1.4	.02-1.0	.013-.75	.01-50	.01-25	.01-10
	30	No Trip	1.0-12	---	.40-5.0	.14-1.9	.052-.73	.03-.40	.02-.27	.015-.20	.012-.14	.01-10	.008-.074	.006-.06	.005-.053	.005-.05
DC 25x	252	No Trip	10-100	---	6-55	2.5-20	.85-4.5	.45-2.5	.30-1.8	20-1.6	.15-1.5	.10-1.4	.08-1.2	.07-1.1	.07-1.0	.06-90
400 Hz 8x	1	No Trip	---	---	30-350	10-120	3.4-35	2.0-25	.86-19	.25-10	.06-2.6	.02-60	.012-25	.01-15	.008-12	.008-10
	2	No Trip	---	---	6.0-70	2.5-26	.85-8.5	.40-5.0	.23-3.1	.10-2.0	.02-1.1	.01-60	.01-30	.01-15	.009-.085	.008-.05
	3	No Trip	---	---	.60-7.0	.20-2.3	.075-.84	.04-.50	.02-.37	.01-.25	.006-.18	.005-.12	.004-.075	.004-.05	.004-.042	.004-.04
50/60 Hz DC 8x	1	No Trip	---	35-520	20-350	9-90	3-26	1.4-15	.45-10	.15-7	.03-4.8	.009-3.7	.006-2.5	.005-2	.005-1.6	.005-1
	2	No Trip	---	7.0-80	4.5-50	1.7-18	.55-6.0	.25-2.8	.11-1.9	.05-1.5	.025-1.2	.015-.80	.011-.41	.01-20	.009-10	.008-.05
	3	No Trip	---	.60-9.0	.40-5.0	.15-1.9	.054-.64	.03-.30	.017-.20	.01-.14	.007-.09	.005-.06	.004-.052	.004-.05	.004-.046	.004-.04
50/60 Hz DC 18x	10	No Trip	---	45-500	30-350	10-120	3.4-42	2.0-22	1.1-12.5	.50-8.0	.17-5.2	.05-4.0	.02-3.4	.01-3.0	.008-2.5	.008-2.0
	20	No Trip	---	7.0-80	4.5-50	1.7-18	.54-6.9	.30-4.0	.18-2.75	.10-2.0	.04-1.4	.02-1.0	.013-.75	.01-50	.01-25	.01-10
	30	No Trip	---	.60-9.0	.40-5.0	.15-1.9	.052-.73	.03-.40	.02-.27	.015-.20	.012-.14	.01-10	.008-.074	.006-.06	.005-.053	.005-.05
50/60/DC	Instant. Delay "P" Max. Time	No Trip	.100	.060	.050	.034	.020	.015	.012	.011	.011	.011	.011	.011	.011	.011

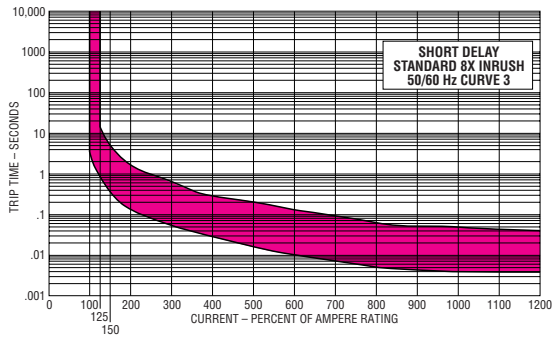
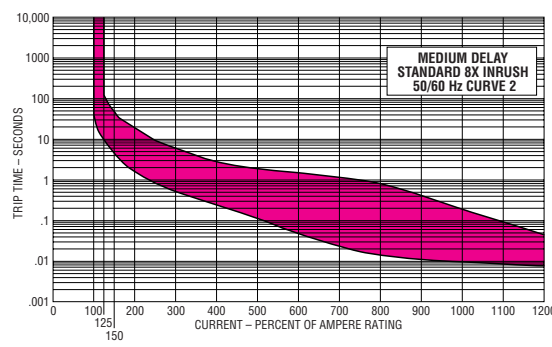
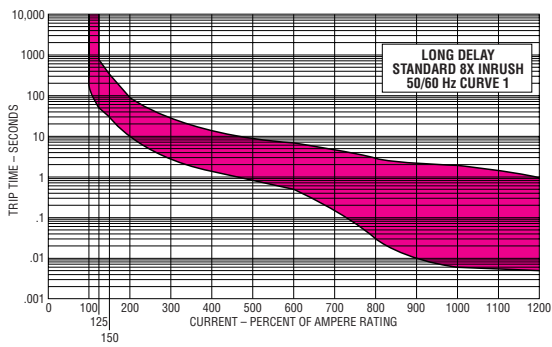

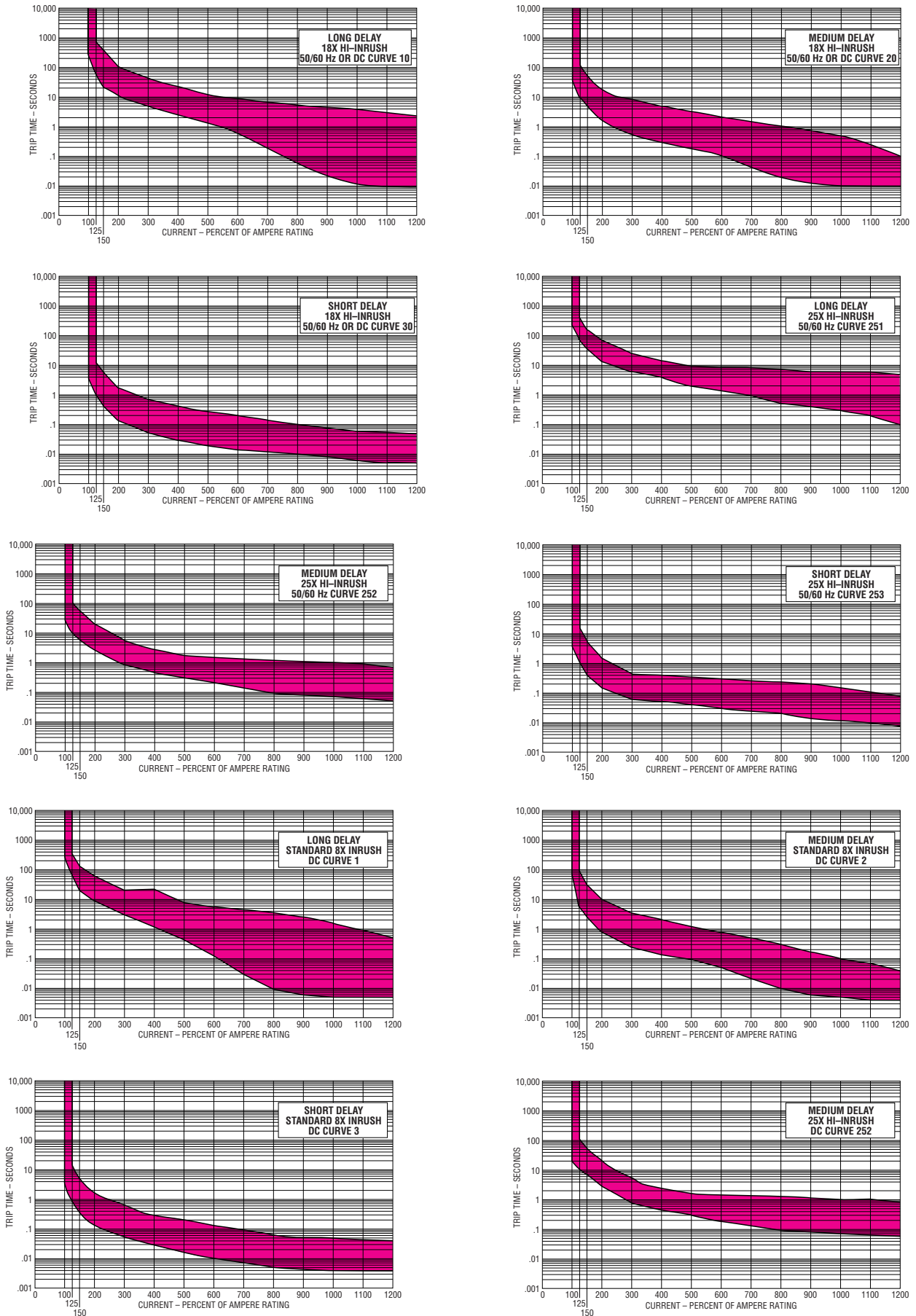

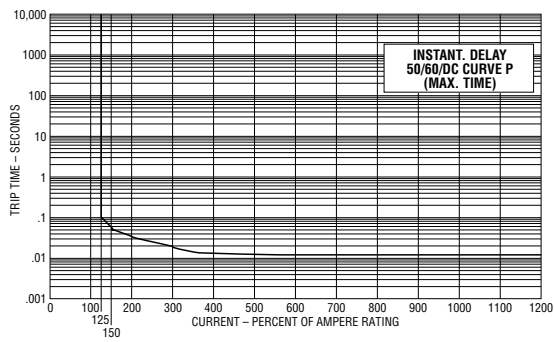
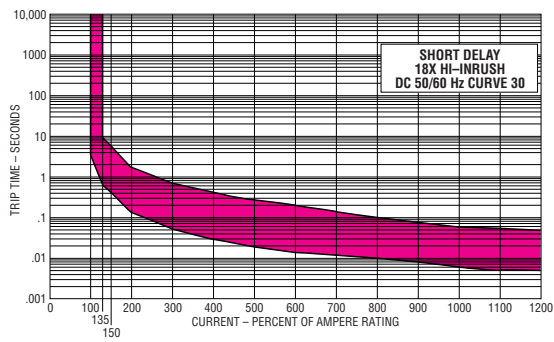
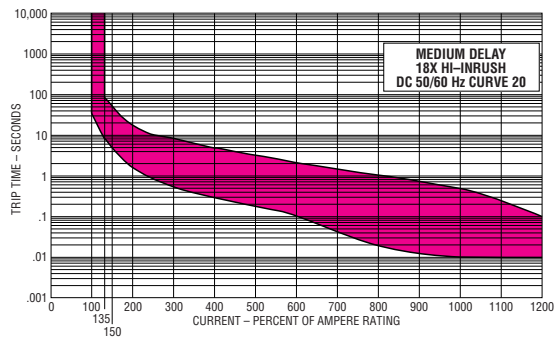
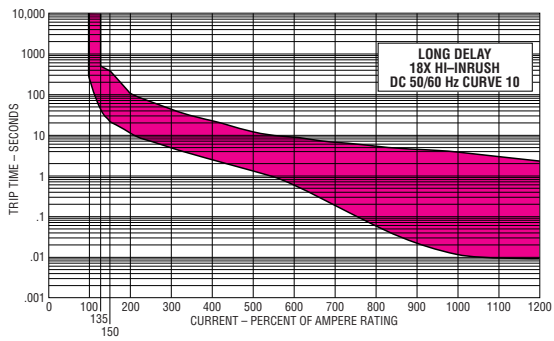
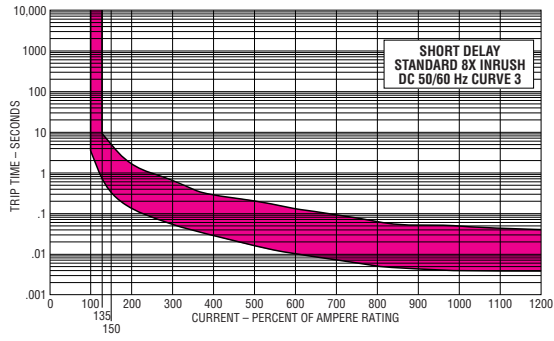
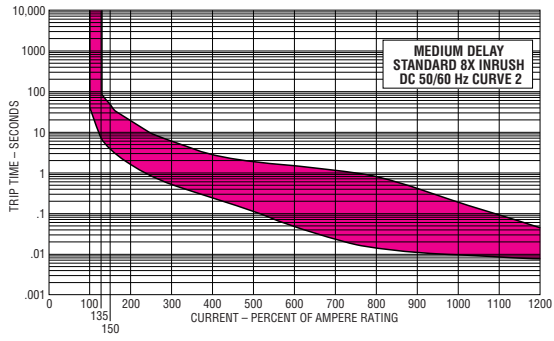
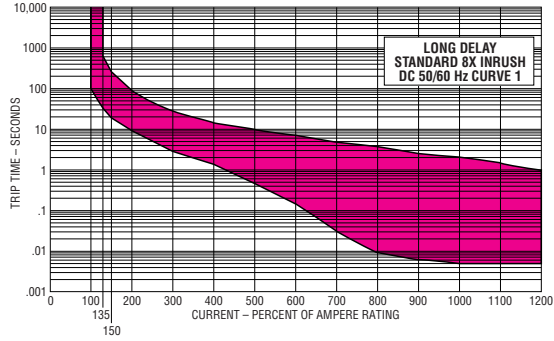
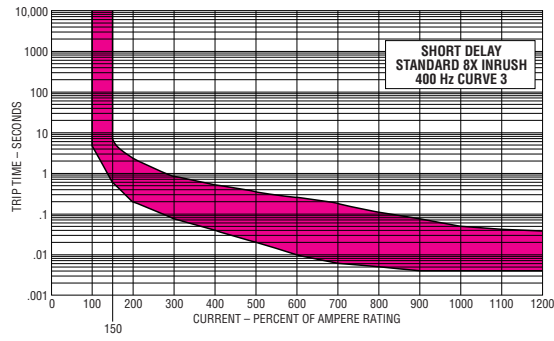
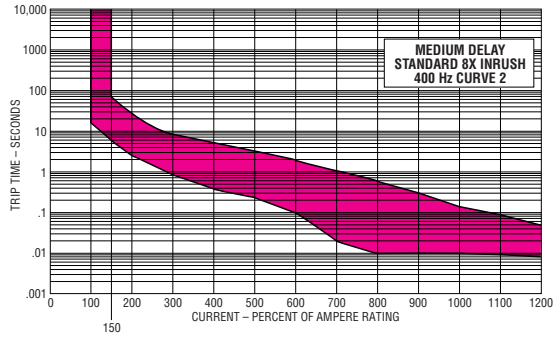
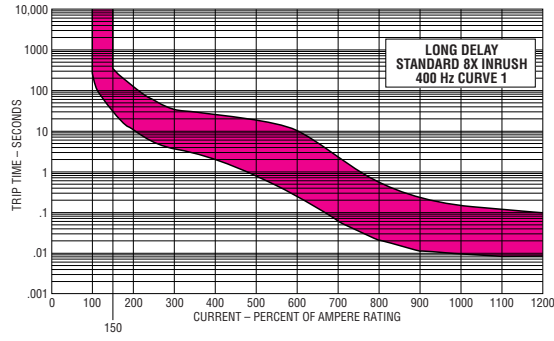

Dimensions

All dimensions are in inches (mm) tolerance $-.020/.51$ except where noted. Dimensions are given here only as preliminary guide to specifying. Final engineering drawings should be made from the latest Heinemann^{fi} factory drawings, available on request.

Note: Two and three pole units shown with non-standard single handle construction. Standard is handle each pole.

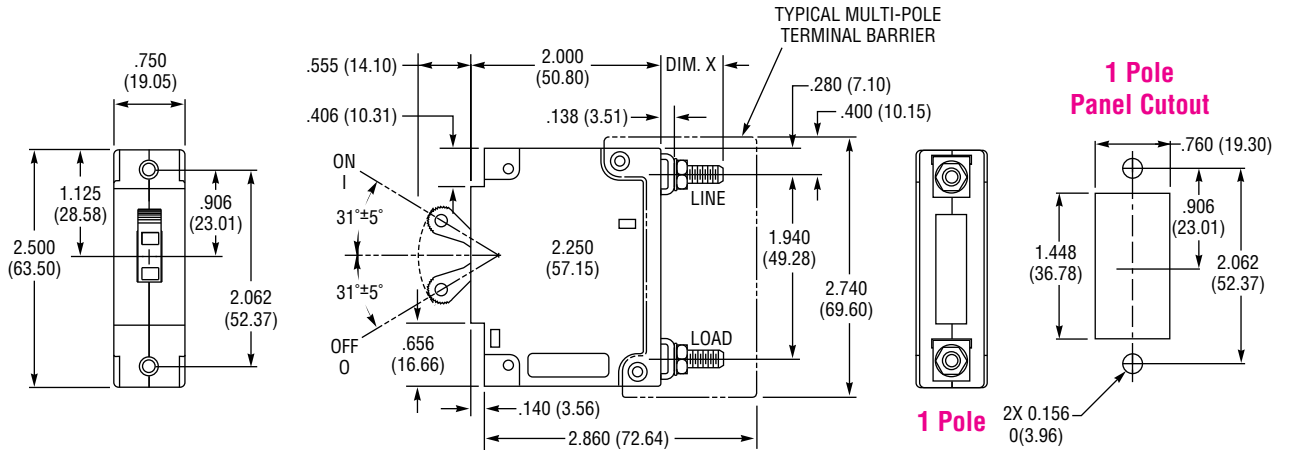

6-32 MOUNTING INSERTS, 2 PER POLE, .195 (4.95) DEEP CLEARANCE RECESS PROVIDED IN MOLDINGS FOR MOUNTING SCREW THREADS. SEE NOTES 3 AND 5.

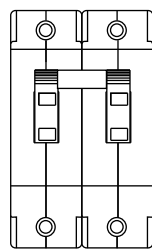
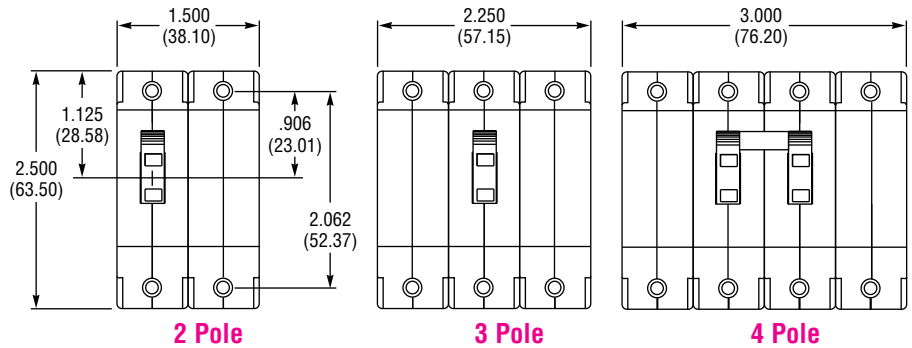

2 Pole

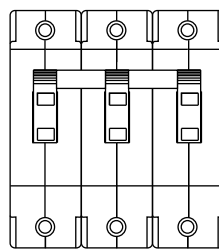

3 Pole

Variation

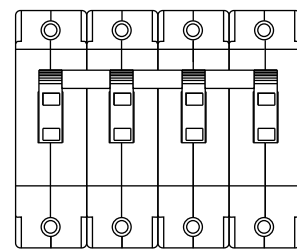

4 Pole

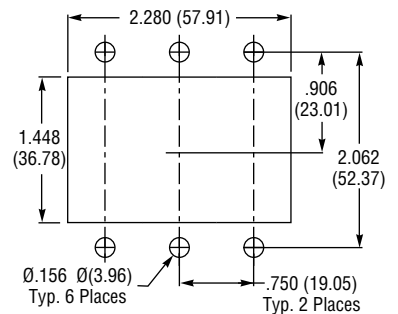
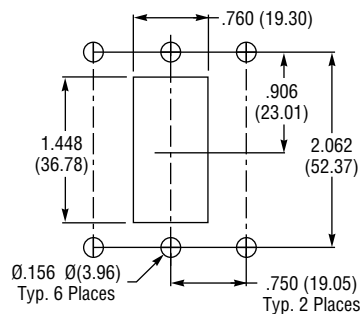
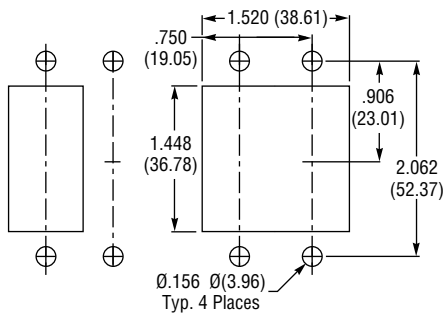

2 and 3 Pole Panel Cutout

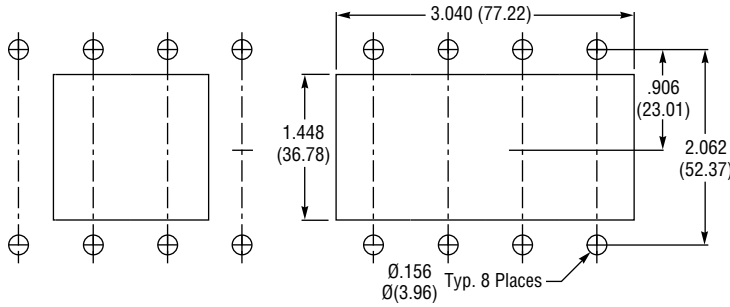

4 Pole Panel Cutout

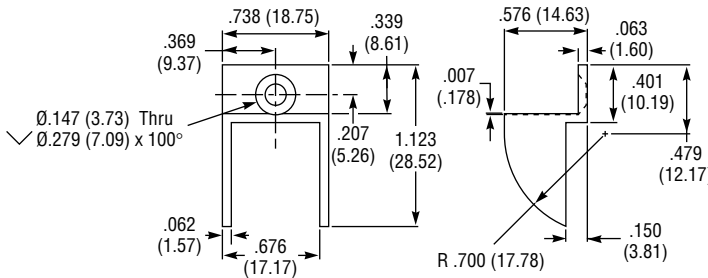
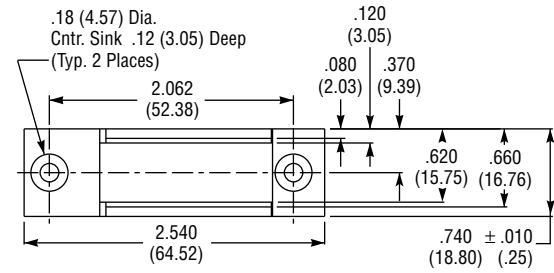

Circuit Breaker Handle Guard

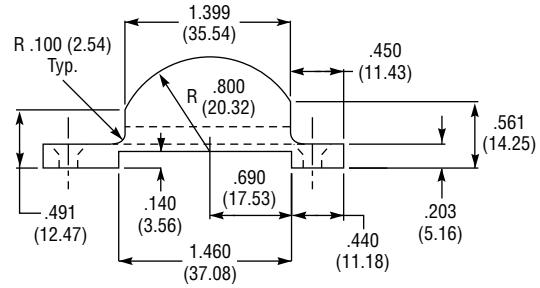

Screw Mount Handle Guard

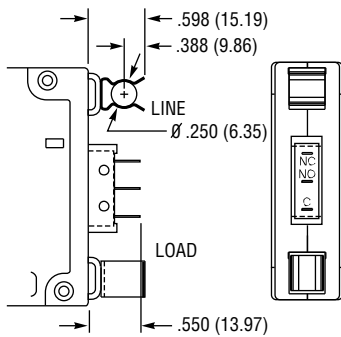

Single Fuse Clip Auxiliary Switch Construction

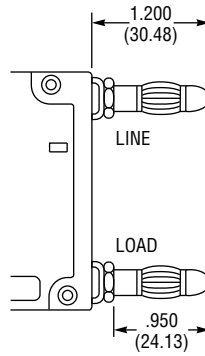

Mounting Pin

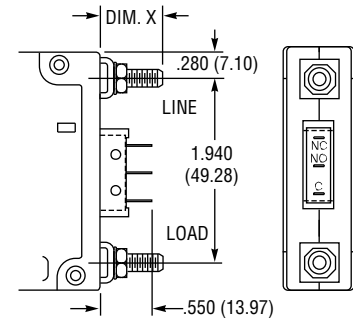

Auxiliary SPDT Switch Configuration

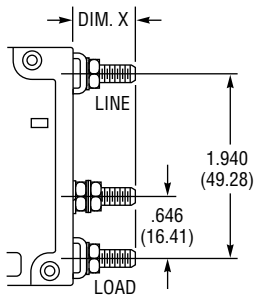

Shunt/Tap Construction

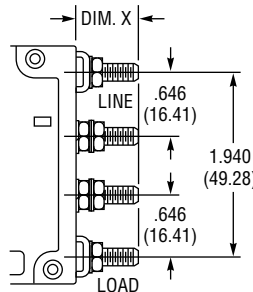

Relay Trip Construction

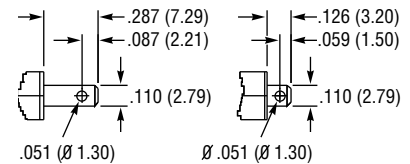

Auxiliary Switch Terminals

Notes:

- Handles are marked with both ON/I and OFF/O.
- 10-32 to 50 amps, ...-20 above 50 amps, also available, M5x0.8 up to 50 amps, M6x1 above 50 amps.
- M3x0.5 pitch mounting clips are available.
- Tightening torque specifications.

Thread size	Torque
#6-32, M3	5-7 in-lbs
#10-32, M5	15-20 in-lbs
...-20, M6	30-35 in-lbs

TERMINAL	0-70 AMPS	71-100 AMPS
X LENGTH	.640/16.26	.695/17.65
X DIA/Ø	10-32	...-20
X LENGTH	.812/20.63	.852/21.64
X DIA/Ø METRIC	M5x0.8	M6x1

Terminal length tol. - .062/1.57

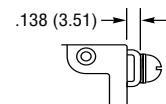

Line Load Terminal Chart

Screw Terminals

Heinemann^{fi} Circuit Breakers Series AM/S

For the widest selection of circuit protection, from 0.01 to 700 amperes, look to Heinemann^{fi}.

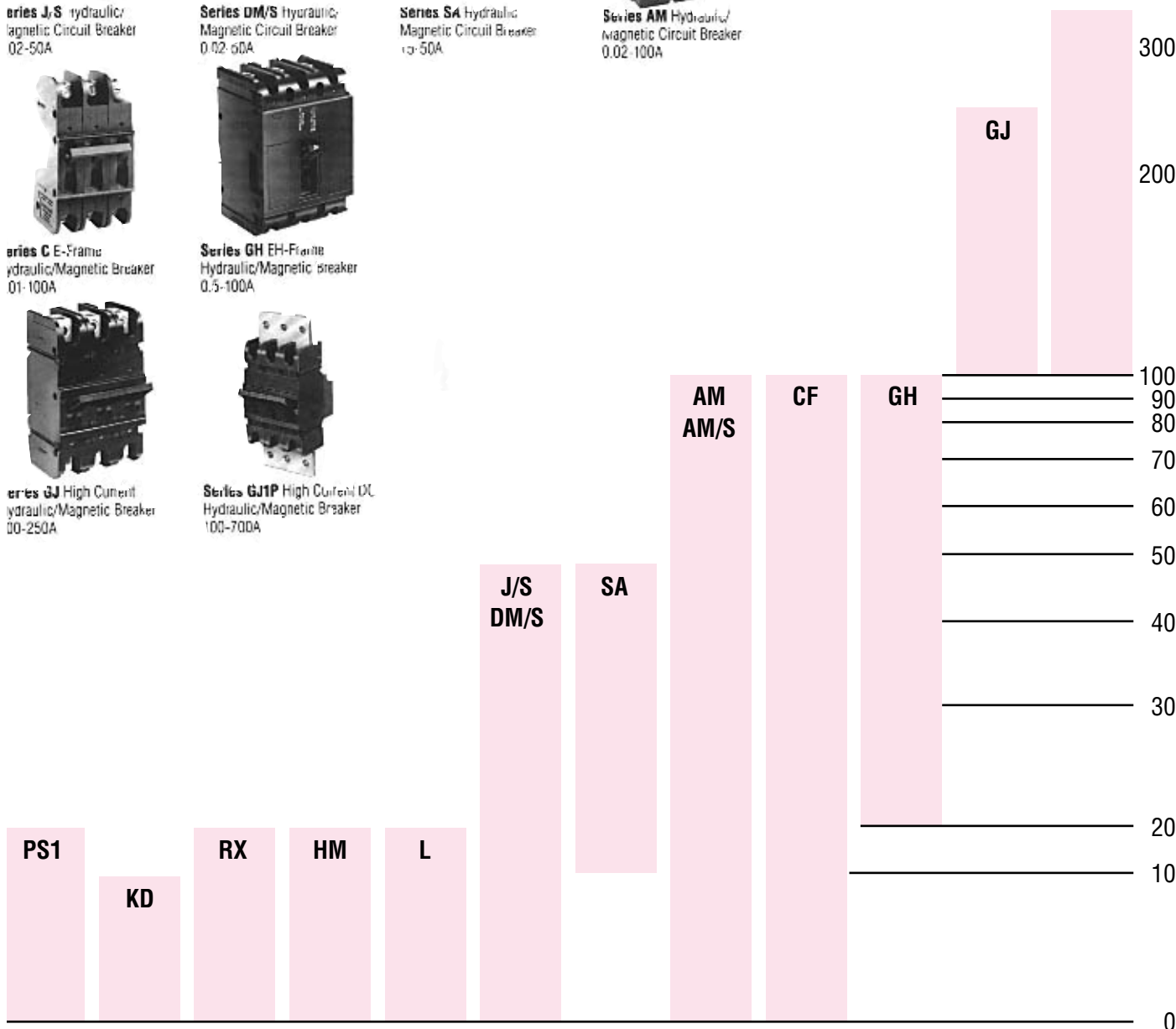
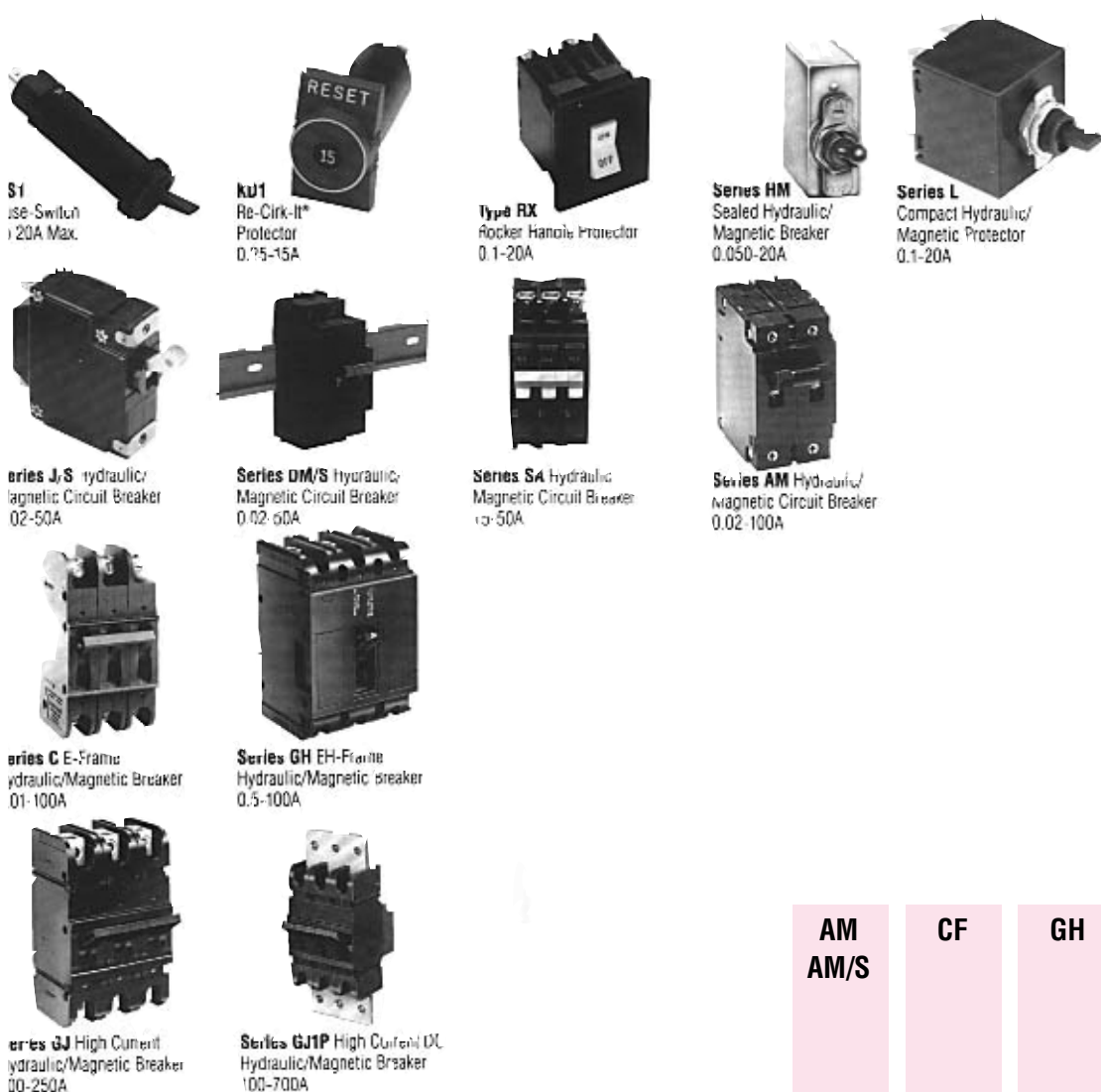

ISO9001
Quality Systems Certified

Arab, AL
Salisbury, MD
Selma, NC
Plymouth, England



Eaton Corporation
Heinemann® Products
2300 Northwood Drive
Salisbury, MD 21801
Phone: (410) 546-9778, Fax: (410) 546-2116

For warranty information, See CMCO Bulletin C-C7.0.
Products described by this catalog are covered by one or more United States of America patents and appropriate foreign patents, where applicable.



Printed in U.S.A.
AM/S-96
GG5M