

Maryland Metrics R955 Series: Accessories for Strain Relief Fittings Summary

Also see Page 45S for a supplementary summary



Locking Nuts - Page 28

- Black & Gray Nylon
- Nickel Plated Brass



O-Rings - Page 30

- Buna-N
- Viton®
- Silicone



Hole Plug - Page 31-32

- Dome Plugs:**
- Black & Gray Nylon
 - Nickel Plated Brass
- Hex Plugs:**
- Black Nylon
 - Nickel Plated Brass
 - Stainless Steel



Wrenches - Page 33

- Deep Socket Wrenches



Thread Reducers - Page 36-38

- Reduces a Type of (NPT, PG, Metric) Thread
- Gray Nylon
 - Nickel Plated Brass
 - Black Nylon
 - Stainless Steel

Viton® is a federally registered trademark of DuPont Dow Elastomer.

Page 29 - Locking Nuts

- EMI/RFI Proof (Nickel Plated Brass)
- Zinc Plated Steel
- Stainless Steel (303) - INOX



Page 30 - Seal Rings

- Polyethylene
- Fiber-Reinforced Plastic



Page 30/33 - Blind Plug/Clamp

- Blind Plugs:**
- Black Nylon
- Cable Clamp:**
- Nickel Plated Brass



Page 34-35 - Thread Adapters

- Converts a Type of (NPT, PG, Metric) Threads
- Black Nylon
 - Nickel Plated Brass



Page 39 - Thread Enlargers

- Enlarges a Type of (NPT, PG, Metric) Threads
- Black Nylon
 - Nickel Plated Brass



Accessories - Locking Nuts

Nylon & Nickel Plated Brass - PG/NPT/Metric



Nylon: Black & Gray Locking Nuts					
Part Numbers		Thread Type & Size	Dimensions in Inches (mm)		
-40 °F to 212 °F (-40 °C to 100 °C)			G	H	
See page 49 for thread specs			Thickness	Wrench Flats	
Black	Gray				
NP-07-BK	NP-07-GY	PG 7	.20 (5)	.75 (19)	
NP-09-BK	NP-09-GY	PG 9	.20 (5)	.87 (22)	
NP-11-BK	NP-11-GY	PG 11	.20 (5)	.94 (24)	
NP-13-BK	NP-13-GY	PG 13 / 13.5	.24 (6)	1.06 (27)	
NP-16-BK	NP-16-GY	PG 16	.24 (6)	1.18 (30)	
NP-21-BK	NP-21-GY	PG 21	.28 (7)	1.41 (36)	
NP-29-BK	NP-29-GY	PG 29	.28 (7)	1.81 (46)	
NP-36-BK	NP-36-GY	PG 36	.31 (8)	2.36 (60)	
NP-42-BK	NP-42-GY	PG 42	.31 (8)	2.56 (65)	
NP-48-BK	NP-48-GY	PG 48	.31 (8)	2.76 (70)	
NN-09-BK	NN-09-GY	3/8" NPT	.28 (7)	.94 (24)	
NN-13-BK	NN-13-GY	1/2" NPT	.24 (6)	1.06 (27)	
NN-21-BK	NN-21-GY	3/4" NPT	.28 (7)	1.26 (32)	
NN-29-BK	NN-29-GY	1" NPT	.28 (7)	1.57 (40)	
NM-12-BK	NM-12-GY	M12 x 1.5	.20 (5)	.67 (17)	
NM-16-BK	NM-16-GY	M16 x 1.5	.20 (5)	.87 (22)	
NM-20-BK	NM-20-GY	M20 x 1.5	.24 (6)	1.06 (27)	
NM-25-BK	NM-25-GY	M25 x 1.5	.26 (6.5)	1.26 (32)	
NM-32-BK	NM-32-GY	M32 x 1.5	.28 (7)	1.61 (41)	
NM-40-BK	NM-40-GY	M40 x 1.5	.28 (7)	1.97 (50)	
NM-50-BK	NM-50-GY	M50 x 1.5	.31 (8)	2.36 (60)	
NM-63-BK	NM-63-GY	M63 x 1.5	.31 (8)	2.95 (75)	



Nylon Locking Nuts

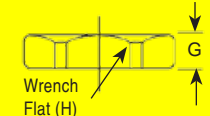

Nickel Plated Brass Locking Nuts



Nickel Plated Brass Locking Nuts

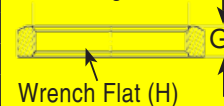

Nickel Plated Brass: Locking Nuts					
Part Numbers		Thread Type & Size	Dimensions in Inches (mm)		
-40 °F to 212 °F (-40 °C to 100 °C)			G	H	
See page 49 for thread specs			Thickness	Wrench Flats	
Nickel Plated Brass					
NP-07-BR	PG 7	.11 (2.8)	.59 (15)		
NP-09-BR	PG 9	.11 (2.8)	.71 (18)		
NP-11-BR	PG 11	.12 (3)	.83 (21)		
NP-13-BR	PG 13 / 13.5	.12 (3)	.91 (23)		
NP-16-BR	PG 16	.12 (3)	1.02 (26)		
NP-21-BR	PG 21	.14 (3.5)	1.26 (32)		
NP-29-BR	PG 29	.16 (4)	1.61 (41)		
NP-36-BR	PG 36	.20 (5)	2.01 (51)		
NP-42-BR	PG 42	.20 (5)	2.36 (60)		
NP-48-BR	PG 48	.22 (5.5)	2.52 (64)		
NN-09-BR	3/8" NPT	.14 (3.5)	.75 (19)		
NN-13-BR	1/2" NPT	.12 (3)	.94 (24)		
NN-21-BR	3/4" NPT	.14 (3.5)	1.18 (30)		
NN-29-BR	1" NPT	.14 (3.5)	1.38 (35)		
NM-06-BR	M6 x 1.0	.10 (2.5)	.39 (10)		
NM-08-BR	M8 x 1.25	.10 (2.5)	.51 (13)		
NM-10-BR	M10 x 1.5	.11 (2.8)	.51 (13)		
NM-12-BR	M12 x 1.5	.11 (2.8)	.59 (15)		
NM-16-BR	M16 x 1.5	.11 (2.8)	.75 (19)		
NM-20-BR	M20 x 1.5	.12 (3)	.91 (23)		
NM-25-BR	M25 x 1.5	.14 (3.5)	1.14 (29)		
NM-32-BR	M32 x 1.5	.16 (4)	1.42 (36)		
NM-40-BR	M40 x 1.5	.18 (4.5)	1.77 (45)		
NM-50-BR	M50 x 1.5	.22 (5.5)	2.17 (55)		
NM-63-BR	M63 x 1.5	.24 (6)	2.76 (70)		

Additional: Nickel Plated Brass Extra Small & Large Locking Nuts are available in Metric: (M6, M8, M10, M63, M75, M80, M90, M100, M110) & BSPP: (G 2-1/2", G 3", G 4") (See Page 45S)



Accessories - Locking Nuts - Zinc Plated Steel, Nickel Plated Brass, Stainless Steel - PG/NPT/Metric

EMI/RFI - Nickel Plated Brass: Locking Nuts				
Part Numbers	Thread Type & Size	Dimensions in Inches (mm)		
		G	H	F
-40 °F to 212 °F (-40 °C to 100 °C)				
	See page 49 for thread specs	Thick-ness	Wrench Flats	Cutting Edge Height
NPB w/ Cutting Edges				
NP-07-BE	PG 7	.11 (2.8)	.59 (15)	.028 (0.7)
NP-09-BE	PG 9	.11 (2.8)	.71 (18)	.028 (0.7)
NP-11-BE	PG 11	.12 (3)	.83 (21)	.028 (0.7)
NP-13-BE	PG 13 / 13.5	.12 (3)	.91 (23)	.028 (0.7)
NP-16-BE	PG 16	.12 (3)	1.02 (26)	.028 (0.7)
NP-21-BE	PG 21	.14 (3.5)	1.26 (32)	.028 (0.7)
NP-29-BE	PG 29	.16 (4)	1.61 (41)	.028 (0.7)
NP-36-BE	PG 36	.20 (5)	2.01 (51)	.028 (0.7)
NP-42-BE	PG 42	.20 (5)	2.36 (60)	.028 (0.7)
NP-48-BE	PG 48	.22 (5.5)	2.52 (64)	.028 (0.7)
NN-13-BE	1/2" NPT	.12 (3)	.94 (24)	.028 (0.7)
NM-12-BE	M12 x 1.5	.11 (2.8)	.59 (15)	.028 (0.7)
NM-16-BE	M16 x 1.5	.11 (2.8)	.75 (19)	.028 (0.7)
NM-20-BE	M20 x 1.5	.12 (3)	.94 (24)	.028 (0.7)
NM-25-BE	M25 x 1.5	.14 (3.5)	1.18 (30)	.028 (0.7)
NM-32-BE	M32 x 1.5	.18 (4.5)	1.42 (36)	.028 (0.7)
NM-40-BE	M40 x 1.5	.20 (5)	1.81 (46)	.028 (0.7)
NM-50-BE	M50 x 1.5	.20 (5)	2.36 (60)	.028 (0.7)
NM-63-BE	M63 x 1.5	.24 (6)	2.76 (70)	.028 (0.7)

These Locking Nuts have cutting edges which will slice through paint coatings on a metal enclosure to ensure grounding. Also, these Locking Nuts are suitable for vibrating applications.

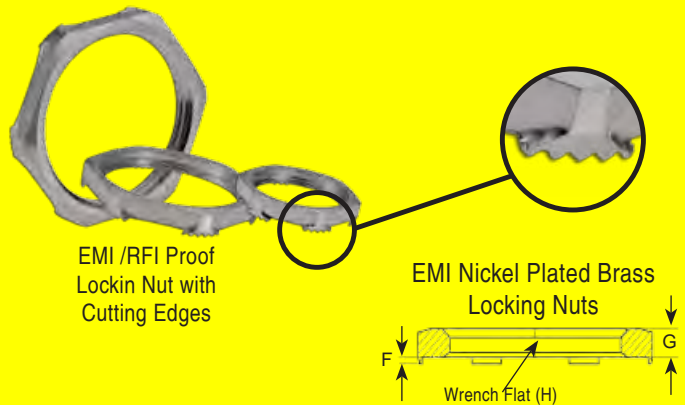

Zinc Plated Steel: Locking Nuts			
Part Numbers	Thread Type & Size	Dimensions in Inches (mm)	
		G	H
	See page 49 for thread specs	Thickness	Wrench Flats
Zinc Plated Steel			
NN-10-ST	1" NPT	.24 (6)	1.73 (44)
NN-34-ST	1-1/4" NPT	.20 (5)	2.01 (53)
NN-36-ST	1-1/2" NPT	.16 (4)	2.19 (55.5)

Note: BE-Locknuts have the following approvals: CE & German Lloyd.

(303) Stainless Steel: Locking Nuts			
Part Numbers	Thread Type & Size	Dimensions in Inches (mm)	
		G	H
-40 °F to 212 °F (40 °C to 100 °C)			
	See page 49 for thread specs	Thickness	Wrench Flats
(303) Stainless Steel			
NP-07-SS	PG 7	.11 (2.8)	.67 (17)
NP-09-SS	PG 9	.11 (2.8)	.87 (22)
NP-11-SS	PG 11	.12 (3)	.87 (22)
NP-13-SS	PG 13 / 13.5	.12 (3)	.94 (24)
NP-16-SS	PG 16	.12 (3)	1.06 (27)
NP-21-SS	PG 21	.14 (3.5)	1.26 (32)
NP-29-SS	PG 29	.16 (4)	1.61 (41)
NP-36-SS	PG 36	.20 (5)	1.97 (50)
NM-12-SS	M12 x 1.5	.12 (3)	.67 (17)
NM-16-SS	M16 x 1.5	.12 (3)	.75 (19)
NM-20-SS	M20 x 1.5	.12 (3)	.95 (24)
NM-25-SS	M25 x 1.5	.16 (4)	1.06 (27)
NM-32-SS	M32 x 1.5	.20 (5)	1.42 (36)
NM-40-SS	M40 x 1.5	.20 (5)	1.81 (46)
NM-50-SS	M50 x 1.5	.20 (5)	2.17 (55)
NM-63-SS	M63 x 1.5	.24 (6)	2.76 (70)

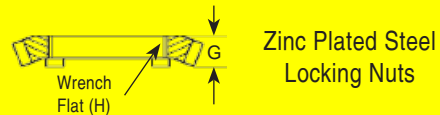

Stainless Steel Locking Nuts

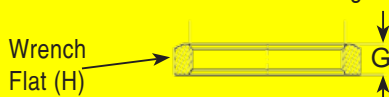





Typical Applications for Stainless Steel:

- Off-shore
- Marine
- Chemical Plants
- Food Processing
- Clean Room
- Other Rugged Applications

For Material Specifications and Approval Information, please refer to page 45.

Accessories - O-Rings & Seal Rings for Strain Relief Fittings - PG/NPT/Metric Threads

Part Numbers		Thread Type & Size	Dimensions in Inches (mm)		
-22 °F to 158 °F (-30 °C to 70 °C)	-67 °F to 572 °F (-55 °C to 300 °C)		A	B	C
		See page 49 for thread specs	Inner Diameter	Outer Diameter	Height
Polyethylene	Fiber-reinforced Plastic				
SR-07-NY	SR-07-HD	PG 7	.49 (12.5)	.65 (16.5)	.06 (1.5)
SR-09-NY	SR-09-HD	PG 9	.60 (15.2)	.75 (19)	.06 (1.5)
SR-11-NY	SR-11-HD	PG 11	.73 (18.6)	.89 (22.5)	.06 (1.5)
SR-13-NY	SR-13-HD	PG 13 / 13.5	.80 (20.4)	.98 (25)	.06 (1.5)
SR-16-NY	SR-16-HD	PG 16	.89 (22.5)	1.06 (27)	.06 (1.5)
SR-21-NY	SR-21-HD	PG 21	1.11 (28.3)	1.32 (33.5)	.06 (1.5)
SR-29-NY	SR-29-HD	PG 29	1.46 (37)	1.71 (43.5)	.08 (2)
SR-36-NY	SR-36-HD	PG 36	1.85 (47)	2.17 (55)	.08 (2)
SR-42-NY	SR-42-HD	PG 42	2.13 (54)	2.48 (63)	.08 (2)
SR-48-NY	SR-48-HD	PG 48	2.33 (59.3)	2.72 (69)	.08 (2)
SR-38-NY	-	3/8" NPT	.67 (17)	.87 (22)	.06 (1.5)
SR-18-NY	-	1/2" NPT	.83 (21)	.98 (25)	.06 (1.5)
SR-34-NY	-	3/4" NPT	1.06 (27)	1.43 (36)	.04 (1)
SR-10-02	-	1" NPT	1.32 (33.5)	1.71 (43)	.09 (2.2)
SR-14-NY	-	1-1/4" NPT	.63 (41.5)	1.95 (49)	.06 (1.5)
SM-12-NY	SM-12-HD	M12 x 1.5	.47 (12)	.63 (16)	.08 (2)
SM-16-NY	SM-16-HD	M16 x 1.5	.63 (16)	.79 (20)	.08 (2)
SM-20-NY	SM-20-HD	M20 x 1.5	.79 (20)	.98 (25)	.08 (2)
SM-25-NY	SM-25-HD	M25 x 1.5	.98 (25)	1.22 (31)	.08 (2)
SM-32-NY	SM-32-HD	M32 x 1.5	1.26 (32)	1.50 (38)	.08 (2)
SM-40-NY	SM-40-HD	M40 x 1.5	1.57 (40)	1.96 (48)	.08 (2)
SM-50-NY	SM-50-HD	M50 x 1.5	1.97 (50)	2.28 (58)	.08 (2)
SM-63-NY	SM-63-HD	M63 x 1.5	2.48 (63)	2.83 (72)	.08 (2)

Part Numbers			Thread Type & Size	Dimensions in Inches (mm)	
-22 °F to 248 °F (-30 °C to 120 °C)	-40 °F to 392 °F (-40 °C to 200 °C)	-76 °F to 482 °F (-60 °C to 250 °C)		D	E
			See page 49 for thread specs	Inner Diameter	Height
Buna-N	Viton®	Silicone			
OR-07-BN	OR-07-VT	OR-07-SI	PG 7	.39 (10)	.06 (1.5)
OR-09-BN	OR-09-VT	OR-09-SI	PG 9	.47 (12)	.06 (1.5)
OR-11-BN	OR-11-VT	OR-11-SI	PG 11	.63 (16)	.06 (1.5)
OR-13-BN	OR-13-VT	OR-13-SI	PG 13 / 13.5	.67 (17)	.07 (1.8)
OR-16-BN	OR-16-VT	OR-16-SI	PG 16	.71 (18)	.06 (1.5)
OR-21-BN	OR-21-VT	OR-21-SI	PG 21	1.02 (26)	.08 (2)
OR-29-BN	OR-29-VT	OR-29-SI	PG 29	1.30 (33)	.08 (2)
OR-36-BN	OR-36-VT	OR-36-SI	PG 36	1.69 (43)	.08 (2)
OR-42-BN	OR-42-VT	OR-42-SI	PG 42	1.97 (50)	.08 (2)
OR-48-BN	OR-48-VT	OR-48-SI	PG 48	2.16 (55)	.08 (2)
OR-38-BN	OR-38-VT	OR-38-SI	3/8" NPT	.51 (13)	.08 (2)
OR-18-BN	OR-18-VT	OR-18-SI	1/2" NPT	.75 (19)	.07 (1.8)
OR-34-BN	OR-34-VT	OR-34-SI	3/4" NPT	.87 (22)	.08 (2)
OR-10-BN	OR-10-VT	OR-10-SI	1" NPT	1.14 (29)	.08 (2)
OR-54-BN	OR-54-VT	OR-54-SI	1-1/4" NPT	1.50 (38)	.10 (2.5)
OR-64-BN	OR-64-VT	OR-64-SI	1-1/2" NPT	1.77 (45)	.10 (2.5)
OM-12-BN	OM-12-VT	OM-12-SI	M12 x 1.5	.39 (10)	.06 (1.5)
OM-16-BN	OM-16-VT	OM-16-SI	M16 x 1.5	.47 (12)	.06 (1.5)
OM-20-BN	OM-20-VT	OM-20-SI	M20 x 1.5	.67 (17)	.07 (1.8)
OM-25-BN	OM-25-VT	OM-25-SI	M25 x 1.5	.87 (22)	.08 (2)
OM-32-BN	OM-32-VT	OM-32-SI	M32 x 1.5	1.14 (29)	.08 (2)
OM-40-BN	OM-40-VT	OM-40-SI	M40 x 1.5	1.38 (35)	.08 (2)
OM-50-BN	OM-50-VT	OM-50-SI	M50 x 1.5	1.69 (43)	.08 (2)
OM-63-BN	OM-63-VT	OM-63-SI	M63 x 1.5	2.17 (55)	.08 (2)

If NEMA 4x or 6 (IP 68 or IP 69K - Submersible) is required, O-Rings or Seal Rings should be used when mounting Strain Relief Fittings to a control panel, secured with a Locking Nut. The straight Strain Relief Fittings feature a molded O-Ring groove. For these fittings the O-Ring is the best solution.

The Snap Elbows and some of the Conduit Fittings don't have a recess for an O-Ring. In that case, the Seal Ring would be the better choice, unless the hole can be beveled to accommodate an O-Ring.



Viton® is a federally registered trademark of DuPont Dow Elastomer.

Accessories - Strain Relief Blind Plugs Nylon - fits PG/NPT/Metric Threads

These non-threaded Plugs are made of Black Nylon (RAL 9005) and fit PG, NPT and Metric Strain Relief Fittings.

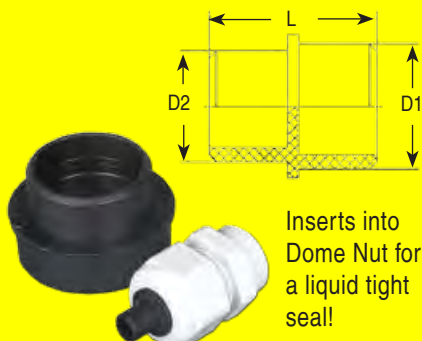



Part Numbers	Fits PG Thread	Fits NPT Thread	Fits Metric Thread	Dimensions in Inches (mm)		
				D1	D2	L
	See page 49 for thread specs	See page 49 for thread specs	See page 49 for thread specs	Diameter (1)	Diameter (2)	Length
PL-07-BK	PG 7	-	M12 x 1.5	.24 (6)	.18 (4.5)	.59 (15)
PL-09-BK	PG 9	3/8" NPT	M16 x 1.5	.26 (7.5)	.22 (5.5)	.67 (17)
PL-11-BK	PG 11	-	M16 x 1.5 - E	.37 (9.5)	.26 (6.5)	.75 (19)
PL-13-BK	PG 13 / 13.5	1/2" NPT	M20 x 1.5	.45 (11.5)	.33 (8.5)	.75 (19)
PL-16-BK	PG 16	1/2" NPT - E	M20 x 1.5 - E	.53 (13.5)	.45 (11.5)	.77 (19.5)
PL-21-BK	PG 21	3/4" NPT	M25 x 1.5	.69 (17.5)	.61 (15.5)	.93 (23.5)
PL-29-BK	PG 29	1" & 1-1/4" NPT	M32 x 1.5	.94 (24)	.75 (19)	1.02 (26)
PL-36-BK	PG 36	1-1/2" NPT	M40 x 1.5	1.22 (31)	.98 (25)	1.10 (28)
PL-42-BK	PG 42	-	M50 x 1.5	1.46 (37)	1.18 (30)	1.10 (28)
PL-48-BK	PG 48	-	M63 x 1.5	1.69 (43)	1.34 (34)	1.10 (28)

30 For Material Specifications and Approval Information, please refer to page 45.

RoHS Dimensions and specifications may be changed without prior notice. 

Accessories - (Dome & Hex) Hole Plugs Nylon & Polypropylene - PG/NPT/Metric Threads

Dome Plugs: Nylon					
Part Numbers		Thread Type & Size	Dimensions in Inches (mm)		
			H	D	E
-40 °F to 212 °F (-40 °C to 100 °C)		See page 49 for thread specs	Overall Height	Dome Diameter	Thread Length
					
DP-07-BK	DP-07-GY	PG 7	.31 (8)	.59 (15)	.24 (6)
DP-09-BK	DP-09-GY	PG 9	.35 (9)	.75 (19)	.24 (6)
DP-11-BK	DP-11-GY	PG 11	.35 (9)	.87 (22)	.24 (6)
DP-13-BK	DP-13-GY	PG 13 / 13.5	.37 (9.5)	.98 (25)	.24 (6)
DP-16-BK	DP-16-GY	PG 16	.37 (9.5)	1.06 (27)	.24 (6)
DP-21-BK	DP-21-GY	PG 21	.43 (11)	1.30 (33)	.31 (8)
DP-29-BK	DP-29-GY	PG 29	.47 (12)	1.73 (44)	.31 (8)
DP-36-BK	DP-36-GY	PG 36	.59 (15)	2.17 (55)	.39 (10)
DP-42-BK	DP-42-GY	PG 42	.63 (16)	2.44 (62)	.39 (10)
DP-48-BK	DP-48-GY	PG 48	.63 (16)	2.72 (69)	.47 (12)
DM-12-BK	DM-12-GY	M12 x 1.5	.39 (10)	.59 (15)	.24 (6)
DM-16-BK	DM-16-GY	M16 x 1.5	.45 (11.5)	.79 (20)	.28 (7)
DM-20-BK	DM-20-GY	M20 x 1.5	.37 (9.5)	.98 (25)	.24 (6)
DM-25-BK	DM-25-GY	M25 x 1.5	.61 (15.5)	1.18 (30)	.43 (11)
DM-32-BK	DM-32-GY	M32 x 1.5	.63 (16)	1.50 (38)	.43 (11)
DM-40-BK	DM-40-GY	M40 x 1.5	.71 (18)	1.81 (46)	.51 (13)
DM-50-BK	DM-50-GY	M50 x 1.5	.73 (18.5)	2.20 (56)	.51 (13)
DM-63-BK	DM-63-GY	M63 x 1.5	.75 (19)	2.72 (69)	.59 (15)

Hex Plugs: Nylon					
Part Numbers		Thread Type & Size	Dimensions in Inches (mm)		
			H	X	E
-4 °F to 176 °F (-20 °C to 80 °C)		See page 49 for thread specs	Overall Height	Wrench Flat	Thread Length
					
HP-07-BK	PG 7 / 1/4" NPT		.51 (13)	.59 (15)	.33 (8.5)
HP-09-BK	PG 9		.51 (13)	.75 (19)	.33 (8.5)
HP-11-BK	PG 11		.57 (14.5)	.94 (24)	.35 (9)
HP-13-BK	PG 13 / 13.5		.57 (14.5)	.94 (24)	.35 (9)
HP-16-BK	PG 16		.63 (16)	1.10 (28)	.41 (10.5)
HP-21-BK	PG 21		.69 (17.5)	1.42 (36)	.45 (11.5)
HP-29-BK	PG 29		.71 (18)	1.81 (46)	.45 (11.5)
HP-36-BK	PG 36		.79 (20)	2.17 (55)	.53 (13.5)
HP-42-BK	PG 42		.79 (20)	2.36 (60)	.53 (13.5)
HP-48-BK	PG 48		.83 (21)	2.76 (70)	.57 (14.5)
HM-12-BK	M12 x 1.5		.51 (13)	.59 (15)	.33 (8.5)
HM-16-BK	M16 x 1.5		.51 (13)	.75 (19)	.33 (8.5)
HM-20-BK	M20 x 1.5		.57 (14.5)	.94 (24)	.35 (9)
HM-25-BK	M25 x 1.5		.63 (16)	1.10 (28)	.41 (10.5)
HM-32-BK	M32 x 1.5		.69 (17.5)	1.42 (36)	.45 (11.5)
HM-40-BK	M40 x 1.5		.71 (18)	1.81 (46)	.45 (11.5)
HM-50-BK	M50 x 1.5		.79 (20)	2.17 (55)	.53 (13.5)
HM-63-BK	M63 x 1.5		.83 (21)	2.76 (70)	.57 (14.5)

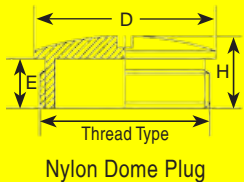

Note: HP & HM Nylon Plugs can be tightened with Hex & Allen wrenches, as well as regular screwdrivers.

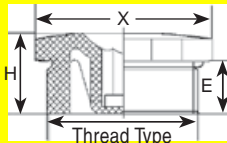

Also available with the following approvals:

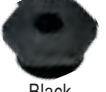

Hex Plugs: Polypropylene					
Part Numbers		Thread Type & Size	Dimensions in Inches (mm)		
			H	X	E
0 °C to 135 °C (32 °F to 275 °F)		See page 49 for thread specs	Overall Height	Wrench Flat	Thread Length
					
HN-38-BK	3/8" NPT		.83 (21)	.75 (19)	.59 (15)
HN-12-BK	1/2" NPT		.81 (20.5)	.94 (24)	.55 (14)
HN-34-BK	3/4" NPT		.87 (22)	1.10 (28)	.63 (16)
HN-10-BK	1" NPT		.91 (23)	1.34 (34)	.67 (17)



Accessories - (Dome) Hole Plugs Nickel Plated Brass - PG/Metric Threads

Dome Plugs: Nickel Plated Brass						
Part Numbers		Thread Type & Size	Dimensions in Inches (mm)			
			H	D	E	E
-40 °F to 176 °F (-40 °C to 80 °C)		See page 49 for thread specs	Overall Height	Dome Diameter	Thread Length	Thread Length w/ O-Ring
						
DP-07-BR	DP-07-BR-B	PG 7	.31 (8)	.55 (14)	.20 (5)	.19 (4.8)
DP-09-BR	DP-09-BR-B	PG 9	.35 (9)	.67 (17)	.24 (6)	.22 (5.5)
DP-11-BR	DP-11-BR-B	PG 11	.35 (9)	.79 (20)	.24 (6)	.22 (5.5)
DP-13-BR	DP-13-BR-B	PG 13 / 13.5	.37 (9.5)	.87 (22)	.26 (6.5)	.24 (6)
DP-16-BR	DP-16-BR-B	PG 16	.37 (9.5)	.94 (24)	.26 (6.5)	.24 (6)
DP-21-BR	DP-21-BR-B	PG 21	.43 (11)	1.18 (30)	.28 (7)	.26 (6.5)
DP-29-BR	DP-29-BR-B	PG 29	.47 (12)	1.54 (39)	.31 (8)	.30 (7.5)
DP-36-BR	DP-36-BR-B	PG 36	.59 (15)	1.97 (50)	.35 (9)	.35 (9)
DP-42-BR	DP-42-BR-B	PG 42	.63 (16)	2.24 (57)	.39 (10)	.39 (10)
DP-48-BR	DP-48-BR-B	PG 48	.63 (16)	2.52 (64)	.39 (10)	.39 (10)

O-Ring needed for Nema 4x.

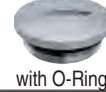
Dome Plugs: Nickel Plated Brass							
Part Numbers		Thread Type & Size	Dimensions in Inches (mm)				
			H	D	E	E	
-40 °F to 176 °F (-40 °C to 80 °C)		See page 49 for thread specs	Overall Height	Dome Diameter	Thread Length	Thread Length w/ O-Ring	
							
DM-12-BR	DM-12-BR-B	M12 x 1.5	.30 (7.5)	.55 (14)	.20 (5)	.26 (6.5)	
DM-16-BR	DM-16-BR-B	M16 x 1.5	.35 (9)	.71 (18)	.20 (5)	.24 (6)	
DM-20-BR	DM-20-BR-B	M20 x 1.5	.37 (9.5)	.87 (22)	.26 (6.5)	.26 (6.5)	
DM-25-BR	DM-25-BR-B	M25 x 1.5	.43 (11)	1.10 (28)	.28 (7)	.28 (7)	
DM-32-BR	DM-32-BR-B	M32 x 1.5	.47 (12)	1.38 (35)	.31 (8)	.31 (8)	
DM-40-BR	DM-40-BR-B	M40 x 1.5	.51 (13)	1.73 (44)	.33 (8.5)	.31 (8)	
DM-50-BR	DM-50-BR-B	M50 x 1.5	.59 (15)	2.13 (54)	.35 (9)	.35 (9)	
DM-63-BR	DM-63-BR-B	M63 x 1.5	.63 (16)	2.64 (67)	.39 (10)	.39 (10)	

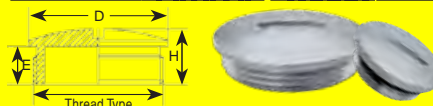



To order hole plug with a Viton® O-Ring instead of Buna-N, replace "-V" (Viton®) to part number (e.g. DP-11-BR-V)

Viton® is a federally registered trademark of DuPont Dow Elastomer.

For Material Specifications and Approval Information, please refer to page 45.



Accessories - (Hex) Hole Plugs Nickel Plated Brass - PG/Metric Threads

Hex Plugs: Nickel Plated Brass						
Part Numbers			Thread Type & Size	Dimensions in Inches (mm)		
-40 °F to 212 °F (-40 °C to 100 °C)	-4 °F to 203 °F (-20 °C to 95 °C)	-4 °F to 356 °F (-20 °C to 180 °C)		H	X	E
 w/o O-Ring	 w/ Buna-N O-Ring	 w/ Viton® O-Ring	See page 49 for thread specs	Overall Height	Wrench Flat	Thread Length
HP-07-BR	HP-07-BR-B	HP-07-BR-V		PG 7 / 1/4" NPT	.31 (8)	.55 (14)
HP-09-BR	HP-09-BR-B	HP-09-BR-V	PG 9	.35 (9)	.67 (17)	.24 (6)
HP-11-BR	HP-11-BR-B	HP-11-BR-V	PG 11	.37 (9.5)	.79 (20)	.24 (6)
HP-13-BR	HP-13-BR-B	HP-13-BR-V	PG 13 / 13.5	.39 (10)	.87 (22)	.26 (6.5)
HP-16-BR	HP-16-BR-B	HP-16-BR-V	PG 16	.39 (10)	.94 (24)	.26 (6.5)
HP-21-BR	HP-21-BR-B	HP-21-BR-V	PG 21	.41 (10.5)	1.18 (30)	.28 (7)
HP-29-BR	HP-29-BR-B	HP-29-BR-V	PG 29	.49 (12.5)	1.61 (41)	.31 (8)
HP-36-BR	HP-36-BR-B	HP-36-BR-V	PG 36	.51 (13)	1.97 (50)	.31 (8)
HP-42-BR	HP-42-BR-B	HP-42-BR-V	PG 42	.59 (15)	2.28 (58)	.35 (9)
HP-48-BR	HP-48-BR-B	HP-48-BR-V	PG 48	.65 (16.5)	2.56 (65)	.39 (10)
HM-12-BR	HM-12-BR-B	HM-12-BR-V	M12 x 1.5	.37 (9.5)	.55 (14)	.26 (6.5)
HM-16-BR	HM-16-BR-B	HM-16-BR-V	M16 x 1.5	.35 (9)	.75 (19)	.24 (6)
HM-20-BR	HM-20-BR-B	HM-20-BR-V	M20 x 1.5	.37 (9.5)	.87 (22)	.24 (6)
HM-25-BR	HM-25-BR-B	HM-25-BR-V	M25 x 1.5	.41 (10.5)	1.18 (30)	.28 (7)
HM-32-BR	HM-32-BR-B	HM-32-BR-V	M32 x 1.5	.49 (12.5)	1.61 (41)	.31 (8)
HM-40-BR	HM-40-BR-B	HM-40-BR-V	M40 x 1.5	.51 (13)	1.81 (46)	.31 (8)
HM-50-BR	HM-50-BR-B	HM-50-BR-V	M50 x 1.5	.59 (15)	2.17 (55)	.35 (9)
HM-63-BR	HM-63-BR-B	HM-63-BR-V	M63 x 1.5	.65 (16.5)	2.76 (70)	.39 (10)

Viton® is a federally registered trademark of DuPont Dow Elastomer.



O-Ring needed for NEMA 4x & 6 Rating.

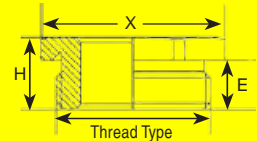

Dome Fittings also available with the following approvals:



Also all Nickel Plated Brass & Stainless Steel HM (Hex) Hole Plugs are available with Ex-d approved



Accessories - (Hex) Hole Plugs (303) Stainless Steel - PG/Metric Threads



These Plugs are designed to fit and seal European PG threads per DIN 46320-FS/PA and Metric threads per DIN 46320/Ms.

They are made of Stainless Steel and are available with Buna-N, Viton® or Silicone O-Ring.

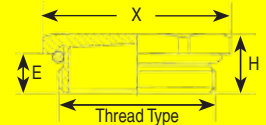

Also available in Nylon or Nickel Plated Brass. (see Page 31)

Optional O-Rings & Other Accessories starting on Page 28 - 39.



Also available with the following ap-



Hex Plugs: (303) Stainless Steel						
Part Numbers			Thread Type & Size	Dimensions in Inches (mm)		
-4 °F to 203 °F (-20 °C to 95 °C)	-4 °F to 356 °F (-20 °C to 180 °C)	-76 °F to 356 °F (-60 °C to 180 °C)		H	X	E
 w/ Buna-N O-Ring	 w/ Viton® O-Ring	 w/ Silicone O-Ring	See page 49 for thread specs	Overall Height	Wrench Flat	Thread Length
HP-07-SS-B	HP-07-SS-V	HP-07-SS-S		PG 7 / 1/4" NPT	.31 (8)	.55 (14)
HP-09-SS-B	HP-09-SS-V	HP-09-SS-S	PG 9	.35 (9)	.67 (17)	.24 (6)
HP-11-SS-B	HP-11-SS-V	HP-11-SS-S	PG 11	.37 (9.5)	.79 (20)	.24 (6)
HP-13-SS-B	HP-13-SS-V	HP-13-SS-S	PG 13 / 13.5	.39 (10)	.87 (22)	.26 (6.5)
HP-16-SS-B	HP-16-SS-V	HP-16-SS-S	PG 16	.39 (10)	.94 (24)	.26 (6.5)
HP-21-SS-B	HP-21-SS-V	HP-21-SS-S	PG 21	.41 (10.5)	1.18 (30)	.28 (7)
HP-29-SS-B	HP-29-SS-V	HP-29-SS-S	PG 29	.49 (12.5)	1.61 (41)	.31 (8)
HP-36-SS-B	HP-36-SS-V	HP-36-SS-S	PG 36	.51 (13)	1.97 (50)	.31 (8)
HM-12-SS-B	HM-12-SS-V	HM-12-SS-S	M12 x 1.5	.37 (9.5)	.55 (14)	.26 (6.5)
HM-16-SS-B	HM-16-SS-V	HM-16-SS-S	M16 x 1.5	.35 (9)	.75 (19)	.24 (6)
HM-20-SS-B	HM-20-SS-V	HM-20-SS-S	M20 x 1.5	.37 (9.5)	.87 (22)	.24 (6)
HM-25-SS-B	HM-25-SS-V	HM-25-SS-S	M25 x 1.5	.41 (10.5)	1.18 (30)	.28 (7)
HM-32-SS-B	HM-32-SS-V	HM-32-SS-S	M32 x 1.5	.49 (12.5)	1.61 (41)	.31 (8)
HM-40-SS-B	HM-40-SS-V	HM-40-SS-S	M40 x 1.5	.51 (13)	1.81 (46)	.31 (8)

Accessories - Cable Clamp Fitting (Low Profile) Fits Metric & PG Threads



Part Numbers -40 °F to 212 °F (-40 °C to 100 °C)	Cable Range	Thread Type & Size See page 49 for thread specs	Dimensions in Inches (mm)			
			A Hole O.D.	H Body Length	T Thread Length	F Wrench Flat
 Nickel Plated Brass						
KL12MA-BR	.20 - .30 (5-7.5)	M12 x 1.5	.47 (12)	.59 (15)	.22 (5.5)	.63 (16)
KL16MA-BR	.28 - .39 (7-10)	M16 x 1.5	.63 (16)	.63 (16)	.24 (6)	.75 (19)
KL20MA-BR	.39 - .55 (10-14)	M20 x 1.5	.79 (20)	.71 (18)	.26 (6.5)	.94 (24)
KL25MA-BR	.47 - .85 (12-21.5)	M25 x 1.5	.98 (25)	.83 (21)	.31 (8)	1.34 (34)
KL32MA-BR	.63 - 1.06 (16-27)	M32 x 1.5	1.26 (32)	.87 (22)	.31 (8)	1.65 (42)
KL40MA-BR	.87 - 1.30 (22-33)	M40 x 1.5	1.57 (40)	1.00 (25.5)	.37 (9.5)	2.05 (52)
KL50MA-BR	.98 - 1.52 (25-38.5)	M50 x 1.5	1.97 (50)	1.00 (25.5)	.37 (9.5)	2.05 (52)

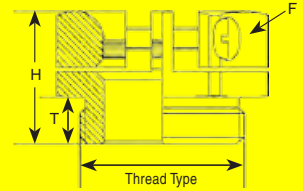

This clamp offers **Extra Pull-out Resistance**. Made of durable Nickel Plated Brass, it offers an excellent solution for your specific application needs. Not a liquid tight solution.

Also available in PG Threads!

Accessories - Deep Socket Wrenches for Strain Relief Fittings - Nickel Plated Brass

Part Numbers Socket Wrench	Used with Sizes		Dimensions in Inches (mm)			
	Nylon Dome Nut See page 49 for thread specs	Brass Dome Nut See page 49 for thread specs	F Wrench Flat	L Length	C Inner Diameter	D Outer Diameter
S-1400-WR		PG7, M12	.55 (14)	2.36 (60)	.35 (9)	.75 (19)
S-1500-WR		PG7, M12	.59 (15)	2.36 (60)	.37 (9.5)	.79 (20)
S-1700-WR		PG 9, 3/8" NPT, M16	.67 (17)	2.36 (60)	.39 (10)	.93 (23.5)
S-1900-WR		PG 9, 3/8" NPT, M16	.75 (19)	2.36 (60)	.43 (11)	1.02 (26)
S-2000-WR		PG 11, M16-E	.79 (20)	2.36 (60)	.47 (12)	1.06 (27)
S-2200-WR		PG 11, 3/8" NPT, M16-E	.87 (22)	2.36 (60)	.51 (13)	1.16 (29.5)
S-2400-WR		PG 13 / 13.5, 1/2" NPT, M20	.94 (24)	2.36 (60)	.59 (15)	1.28 (32.5)
S-2700-WR		PG 16, 1/2" NPT-E, M20-E	1.06 (27)	2.36 (60)	.67 (17)	1.40 (35.5)
S-3000-WR		PG 21, 3/4" NPT, M25	1.18 (30)	2.36 (60)	.71 (18)	1.59 (40.5)
S-3300-WR		PG 21, 3/4" NPT, M25	1.30 (33)	2.36 (60)	.79 (20)	1.71 (43.5)
S-3600-WR		PG 21	1.42 (36)	2.36 (60)	.87 (22)	1.87 (47.5)
S-4000-WR		PG 29, 1" NPT, M32	1.57 (40)	3.94 (100)	.98 (25)	2.07 (52.5)
S-4100-WR		PG 29	1.61 (41)	3.94 (100)	1.06 (27)	2.11 (53.5)
S-4200-WR		PG 29, 1", 1-1/4" NPT, M32	1.65 (42)	3.94 (100)	1.06 (27)	2.15 (54.5)
S-4600-WR		1-1/4" NPT	1.81 (46)	3.94 (100)	1.22 (31)	2.36 (60)
S-5000-WR		PG 36, M40	1.97 (50)	3.94 (100)	1.26 (32)	2.58 (65.5)
S-5300-WR		PG 36, 1-1/2" NPT, M40	2.09 (53)	3.94 (100)	1.26 (32)	2.82 (71.5)
S-5500-WR		M 50	2.17 (55)	3.94 (100)	1.26 (32)	2.83 (72)
S-5700-WR		PG 42, M50	2.24 (57)	3.94 (100)	1.42 (36)	2.97 (75.5)
S-6000-WR		PG 42, M50	2.36 (60)	3.94 (100)	1.50 (38)	3.09 (78.5)
S-6400-WR		PG 48, M63	2.52 (64)	3.94 (100)	1.57 (40)	3.31 (84)
S-6500-WR		PG 48, M63	2.56 (65)	3.94 (100)	1.65 (42)	3.35 (85)
S-6800-WR		M63	2.68 (68)	3.94 (100)	1.65 (42)	3.43 (87)

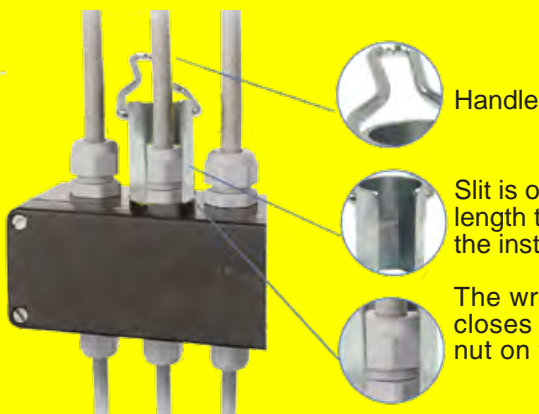

The handy, light weight **Deep Socket Wrench** is manufactured from alloy steel. It is slit open along the full length to accommodate the installed cable during tightening of the dome nut. The wrench encloses the dome nut on five sides, giving the nut additional rigidity during tightening. This is especially important if a stiff cable is used. Does not work with all Flex Fittings.



For Material Specifications and Approval Information, please refer to page 45.

Accessories - Thread Adapters - Nylon (Hex & Round) - PG/NPT/Metric Threads

Operating Temperature (Nylon Adapters): -40 °F to 176 °F (-40 °C to 80 °C)



Type A

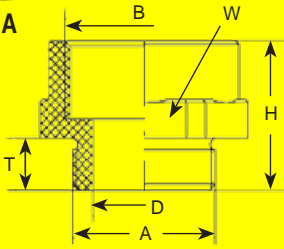

Type B

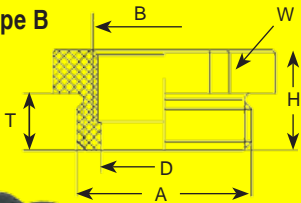

Type C

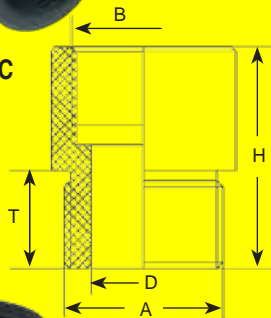

Type D

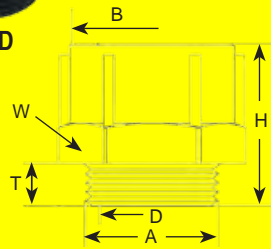

Type E

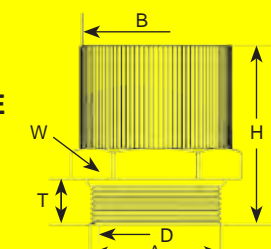

Black Nylon - Thread Adapters: Metric to PG Threads

Part Numbers	Threads		Adapter Type	Dimensions in Inches (mm)			
	Male Thread A	Female Thread B		T	H	D	W
				Thread Length	Height	Inner Diameter	Wrench Flat
AF-1207-BK	M12 x 1.5	PG 7	A	.31 (8)	.79 (20)	.26 (6.5)	.67 (17)
AF-1609-BK	M16 x 1.5	PG 9	C	.59 (15)	1.34 (34)	.33 (8.5)	N/A
AF-2013-BK	M20 x 1.5	PG 13	A	.31 (8)	.83 (21)	.55 (14)	.98 (25)
AF-2513-BK	M25 x 1.5	PG 13 / 13.5	B	.31 (8)	.55 (14)	.71 (18)	1.14 (29)
AF-2516-BK	M25 x 1.5	PG 16	A	.31 (8)	.87 (22)	.71 (18)	1.14 (29)
AF-3221-BK	M32 x 1.5	PG 21	A	.39 (10)	.98 (25)	.98 (25)	1.43 (36)
AF-4029-BK	M40 x 1.5	PG 29	A	.39 (10)	.98 (25)	1.30 (33)	1.77 (45)
AF-5036-BK	M50 x 1.5	PG 36	A	.47 (12)	1.14 (29)	1.69 (43)	2.17 (55)
AF-6342-BK	M63 x 1.5	PG 42	C	.59 (15)	.79 (20)	2.05 (52)	N/A
AF-6348-BK	M63 x 1.5	PG 48	C	.59 (15)	1.38 (35)	2.01 (51)	N/A

Black Nylon - Thread Adapters: PG to Metric Threads

Part Numbers	Threads		Adapter Type	Dimensions in Inches (mm)			
	Male Thread A	Female Thread B		T	H	D	W
				Thread Length	Height	Inner Diameter	Wrench Flat
AP-0712-BK	PG 7	M12 x 1.5	C	.59 (15)	1.34 (34)	.24 (6)	N/A
AP-0912-BK	PG 9	M12 x 1.5	C	.59 (15)	1.34 (34)	.33 (8.5)	N/A
AP-0916-BK	PG 9	M16 x 1.5	A	.31 (8)	.79 (20)	.35 (9)	.83 (21)
AP-1116-BK	PG 11	M16 x 1.5	C	.59 (15)	1.34 (34)	.45 (11.5)	N/A
AP-1120-BK	PG 11	M20 x 1.5	C	.59 (15)	1.34 (34)	.45 (11.5)	N/A
AP-1316-BK	PG 13 / 13.5	M16 x 1.5	B	.31 (8)	.55 (14)	.55 (14)	.98 (25)
AP-1320-BK	PG 13	M20 x 1.5	A	.31 (8)	.83 (21)	.55 (14)	.98 (25)
AP-1620-BK	PG 16	M20 x 1.5	A	.31 (8)	.83 (21)	.63 (16)	1.06 (27)
AP-1625-BK	PG 16	M25 x 1.5	A	.31 (8)	.91 (23)	.63 (16)	1.18 (30)
AP-2125-BK	PG 21	M25 x 1.5	C	.59 (15)	1.34 (34)	.81 (20.5)	N/A
AP-2132-BK	PG 21	M32 x 1.5	A	.31 (8)	.91 (23)	.83 (21)	1.46 (37)
AP-2932-BK	PG 29	M32 x 1.5	C	.59 (15)	1.34 (34)	1.10 (28)	N/A
AP-2940-BK	PG 29	M40 x 1.5	A	.39 (10)	1.06 (27)	1.18 (30)	1.77 (45)
AP-3640-BK	PG 36	M40 x 1.5	C	.59 (15)	.79 (20)	1.50 (38)	N/A
AP-3650-BK	PG 36	M50 x 1.5	C	.59 (15)	1.36 (34.5)	1.46 (37)	N/A
AP-4240-BK	PG 42	M40 x 1.5	C	.59 (15)	.79 (20)	1.50 (38)	N/A
AP-4250-BK	PG 42	M50 x 1.5	C	.59 (15)	1.36 (34.5)	1.69 (43)	N/A
AP-4850-BK	PG 48	M50 x 1.5	C	.59 (15)	.79 (20)	1.50 (38)	N/A
AP-4863-BK	PG 48	M63 x 1.5	C	.59 (15)	1.38 (35)	1.89 (48)	N/A

Black Nylon - Thread Adapters: PG to NPT Threads

Part Numbers	Threads		Adapter Type	Dimensions in Inches (mm)			
	Male Thread A	Female Thread B		T	H	D	W
				Thread Length	Height	Inner Diameter	Wrench Flat
AG-1112-BK	PG 11	1/2" NPT	D	.28 (7)	.83 (21)	N/A	.94 (24)
AG-1312-BK	PG 13 / 13.5	1/2" NPT	D	.35 (9)	.91 (23)	N/A	.94 (24)

Black Nylon - Thread Adapters: Metric to NPT Threads

Part Numbers	Threads		Adapter Type	Dimensions in Inches (mm)			
	Male Thread A	Female Thread B		T	H	D	W
				Thread Length	Height	Inner Diameter	Wrench Flat
AM-1612-BK	M16 x 1.5	1/2" NPT	E	.28 (7)	1.10 (28)	N/A	1.02 (26)
AM-2012-BK	M20 x 1.5	1/2" NPT	E	.28 (7)	1.06 (27)	N/A	1.02 (26)

See page 49 for thread specifications.



Dimensions and specifications may be changed without prior notice.





Accessories - Thread Reducers - Nickel Plated Brass (Hex & Round) - PG/NPT/Metric Threads



Is your thread size off by one size?

These Reducers will solve that threading problem. They convert holes which fit PG, NPT or Metric threads to a smaller female thread of the same thread type.

Thread Reducers: Metric to Metric Threads*					
Part Numbers	Threads		Dimensions in Inches (mm)		
	Male Thread A	Female Thread B	D	T	H
			Outer Diameter	Thread Length	Height
 without O-Ring					
RR-1612-BR	M16 x 1.5	M12 x 1.5	.71 (18)	.24 (6)	.33 (8.5)
RR-2012-BR	M20 x 1.5	M12 x 1.5	.94 (24)	.26 (6.5)	.35 (9)
RR-2016-BR	M20 x 1.5	M16 x 1.5	.94 (24)	.26 (6.5)	.35 (9)
RR-2516-BR	M25 x 1.5	M16 x 1.5	1.18 (30)	.28 (7)	.39 (10)
RR-2520-BR	M25 x 1.5	M20 x 1.5	1.18 (30)	.28 (7)	.39 (10)
RR-3220-BR	M32 x 1.5	M20 x 1.5	1.54 (39)	.31 (8)	.45 (11.5)
RR-3225-BR	M32 x 1.5	M25 x 1.5	1.54 (39)	.31 (8)	.45 (11.5)
RR-4025-BR	M40 x 1.5	M25 x 1.5	1.69 (43)	.31 (8)	.45 (11.5)
RR-4032-BR	M40 x 1.5	M32 x 1.5	1.69 (43)	.35 (9)	.49 (12.5)
RR-5032-BR	M50 x 1.5	M32 x 1.5	2.24 (57)	.39 (10)	.55 (14)
RR-5040-BR	M50 x 1.5	M40 x 1.5	2.24 (57)	.39 (10)	.55 (14)
RR-6340-BR	M63 x 1.5	M40 x 1.5	2.52 (64)	.39 (10)	.55 (14)
RR-6350-BR	M63 x 1.5	M50 x 1.5	2.52 (64)	.39 (10)	.55 (14)

Thread Reducers: PG to PG Threads*					
Part Numbers	Threads		Dimensions in Inches (mm)		
	Male Thread A	Female Thread B	D	T	H
			Outer Diameter	Thread Length	Height
 without O-Ring					
RR-0907-BR	PG 9	PG 7	.67 (17)	.24 (6)	.33 (8.5)
RR-1107-BR	PG 11	PG 7	.79 (20)	.24 (6)	.33 (8.5)
RR-1109-BR	PG 11	PG 9	.79 (20)	.24 (6)	.33 (8.5)
RR-1309-BR	PG 13 / 13.5	PG 9	.87 (22)	.26 (6.5)	.35 (9)
RR-1311-BR	PG 13 / 13.5	PG 11	.87 (22)	.26 (6.5)	.35 (9)
RR-1609-BR	PG 16	PG 9	.94 (24)	.26 (6.5)	.37 (9.5)
RR-1611-BR	PG 16	PG 11	.94 (24)	.26 (6.5)	.37 (9.5)
RR-1613-BR	PG 16	PG 13 / 13.5	.94 (24)	.26 (6.5)	.37 (9.5)
RR-2111-BR	PG 21	PG 11	1.18 (30)	.28 (7)	.39 (10)
RR-2113-BR	PG 21	PG 13 / 13.5	1.18 (30)	.28 (7)	.39 (10)
RR-2116-BR	PG 21	PG 16	1.18 (30)	.28 (7)	.39 (10)
RR-2916-BR	PG 29	PG 16	1.54 (39)	.31 (8)	.45 (11.5)
RR-2921-BR	PG 29	PG 21	1.54 (39)	.31 (8)	.45 (11.5)
RR-3621-BR	PG 36	PG 21	1.97 (50)	.35 (9)	.49 (12.5)
RR-3629-BR	PG 36	PG 29	1.97 (50)	.35 (9)	.49 (12.5)
RR-4229-BR	PG 42	PG 29	2.24 (57)	.39 (10)	.55 (14)
RR-4236-BR	PG 42	PG 36	2.24 (57)	.39 (10)	.55 (14)
RR-4836-BR	PG 48	PG 36	2.52 (64)	.39 (10)	.55 (14)
RR-4842-BR	PG 48	PG 42	2.52 (64)	.39 (10)	.55 (14)

Operating Temperature (Nickel Plated Brass Reducers):
 -40 °C to 100 °C
 (-40 °F to 212 °F)

Reducers are also available with the following approvals:



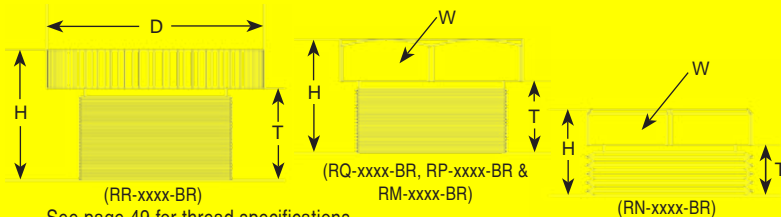

ATEX



36 See page 49 for thread specifications.

RoHS Dimensions and specifications may be changed without prior notice. BDE

Thread Reducers: PG to PG Threads						
Part Numbers		Threads		Dimensions in Inches (mm)		
 w/ Buna-N O-Ring	 without O-Ring	Male Thread A	Female Thread B	W	T	H
				Wrench Flat	Thread Length	Height
RQ-0907-BR	RP-0907-BR	PG 9	PG 7	.67 (17)	.24 (6)	.34 (8.8)
RQ-1107-BR	RP-1107-BR	PG 11	PG 7	.79 (20)	.24 (6)	.35 (9)
RQ-1109-BR	RP-1109-BR	PG 11	PG 9	.79 (20)	.24 (6)	.35 (9)
RQ-1309-BR	RP-1309-BR	PG 13 / 13.5	PG 9	.87 (22)	.26 (6.5)	.37 (9.5)
RQ-1311-BR	RP-1311-BR	PG 13 / 13.5	PG 11	.87 (22)	.26 (6.5)	.37 (9.5)
RQ-1609-BR	RP-1609-BR	PG 16	PG 9	.94 (24)	.26 (6.5)	.37 (9.5)
RQ-1611-BR	RP-1611-BR	PG 16	PG 11	.94 (24)	.26 (6.5)	.37 (9.5)
RQ-1613-BR	RP-1613-BR	PG 16	PG 13 / 13.5	.94 (24)	.26 (6.5)	.37 (9.5)
RQ-2111-BR	RP-2111-BR	PG 21	PG 11	1.18 (30)	.28 (7)	.41 (10.3)
RQ-2113-BR	RP-2113-BR	PG 21	PG 13 / 13.5	1.18 (30)	.28 (7)	.41 (10.3)
RQ-2116-BR	RP-2116-BR	PG 21	PG 16	1.18 (30)	.28 (7)	.41 (10.3)
RQ-2916-BR	RP-2916-BR	PG 29	PG 16	1.57 (40)	.31 (8)	.45 (11.5)
RQ-2921-BR	RP-2921-BR	PG 29	PG 21	1.57 (40)	.31 (8)	.45 (11.5)
RQ-3621-BR	RP-3621-BR	PG 36	PG 21	1.97 (50)	.35 (9)	.49 (12.5)
RQ-3629-BR	RP-3629-BR	PG 36	PG 29	1.97 (50)	.35 (9)	.49 (12.5)
RQ-4229-BR	RP-4229-BR	PG 42	PG 29	2.24 (57)	.39 (10)	.53 (13.5)
RQ-4236-BR	RP-4236-BR	PG 42	PG 36	2.24 (57)	.39 (10)	.53 (13.5)
RQ-4836-BR	RP-4836-BR	PG 48	PG 36	2.52 (64)	.39 (10)	.53 (13.5)
RQ-4842-BR	RP-4842-BR	PG 48	PG 42	2.52 (64)	.39 (10)	.53 (13.5)

Thread Reducers: Metric to Metric Threads					
Part Numbers	Threads		Dimensions in Inches (mm)		
	Male Thread A	Female Thread B	W	T	H
			Wrench Flat	Thread Length	Height
 w/ Buna-N O-Ring					
RM-1612-BR	M16 x 1.5	M12 x 1.5	.67 (17)	.20 (5)	.31 (8)
RM-2012-BR	M20 x 1.5	M12 x 1.5	.87 (22)	.24 (6)	.35 (9)
RM-2016-BR	M20 x 1.5	M16 x 1.5	.87 (22)	.24 (6)	.35 (9)
RM-2516-BR	M25 x 1.5	M16 x 1.5	1.06 (27)	.28 (7)	.39 (10)
RM-2520-BR	M25 x 1.5	M20 x 1.5	1.06 (27)	.28 (7)	.39 (10)
RM-3216-BR	M32 x 1.5	M16 x 1.5	1.34 (34)	.31 (8)	.43 (11)
RM-3220-BR	M32 x 1.5	M20 x 1.5	1.34 (34)	.31 (8)	.43 (11)
RM-3225-BR	M32 x 1.5	M25 x 1.5	1.34 (34)	.31 (8)	.43 (11)
RM-4020-BR	M40 x 1.5	M20 x 1.5	1.46 (43)	.31 (8)	.47 (12)
RM-4025-BR	M40 x 1.5	M25 x 1.5	1.46 (43)	.31 (8)	.47 (12)
RM-4032-BR	M40 x 1.5	M32 x 1.5	1.46 (43)	.31 (8)	.47 (12)
RM-5025-BR	M50 x 1.5	M25 x 1.5	2.17 (55)	.35 (9)	.51 (13)
RM-5032-BR	M50 x 1.5	M32 x 1.5	2.17 (55)	.35 (9)	.51 (13)
RM-5040-BR	M50 x 1.5	M40 x 1.5	2.17 (55)	.35 (9)	.51 (13)
RM-6332-BR	M63 x 1.5	M32 x 1.5	2.56 (65)	.39 (10)	.55 (14)
RM-6340-BR	M63 x 1.5	M40 x 1.5	2.56 (65)	.39 (10)	.55 (14)
RM-6350-BR	M63 x 1.5	M50 x 1.5	2.56 (65)	.39 (10)	.55 (14)

Thread Reducers: NPT to NPT Threads*					
Part Numbers	Threads		Dimensions in Inches (mm)		
	Male Thread A	Female Thread B	W	T	H
			Wrench Flat	Thread Length	Height
					
RN-3412-BR	3/4" NPT	1/2" NPT	1.18 (30)	.71 (18)	.87 (22)
RN-1034-BR	1" NPT	3/4" NPT	1.30 (33)	.98 (25)	1.14 (29)
RN-5410-BR	1-1/4" NPT	1" NPT	1.69 (43)	.98 (25)	1.14 (29)

Accessories - Thread Reducers - Nylon & Polypropylene - (Hex & Round) - PG/NPT/Metric



Gray Nylon - Thread Reducers: PG to PG Threads*							
Part Numbers	Threads		Adapter Type	Dimensions in Inches (mm)			
	Male Thread A	Female Thread B		T	H	D	W
				Thread Length	Height	Outer Diameter	Wrench Flat
RR-0907-GY	PG 9	PG 7	B	.31 (8)	.55 (14)	.75 (19)	N/A
RR-1109-GY	PG 11	PG 9	B	.31 (8)	.71 (18)	.89 (22.5)	N/A
RR-1309-GY	PG 13 / 13.5	PG 9	A	.31 (8)	.47 (12)	1.06 (27)	N/A
RR-1311-GY	PG 13 / 13.5	PG 11	B	.35 (9)	.83 (21)	1.0 (25.5)	N/A
RR-1609-GY	PG 16	PG 9	A	.39 (10)	.51 (13)	1.14 (29)	N/A
RR-1611-GY	PG 16	PG 11	A	.39 (10)	.51 (13)	1.14 (29)	N/A
RR-1613-GY	PG 16	PG 13 / 13.5	B	.39 (10)	.98 (25)	1.13 (28.5)	N/A
RR-2113-GY	PG 21	PG 13 / 13.5	A	.43 (11)	.53 (13.5)	1.42 (36)	N/A
RR-2116-GY	PG 21	PG 16	A	.43 (11)	.53 (13.5)	1.42 (36)	N/A
RR-2921-GY	PG 29	PG 21	A	.43 (11)	.53 (13.5)	1.81 (46)	N/A
RR-3629-GY	PG 36	PG 29	A	.43 (11)	.59 (15)	2.28 (58)	N/A



Type A

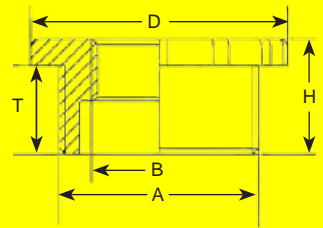

Type B

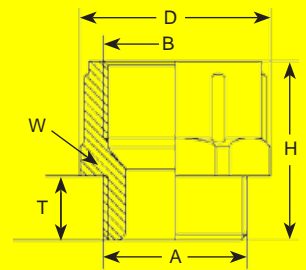

Gray Nylon - Thread Reducers: Metric to Metric Threads*							
Part Numbers	Threads		Adapter Type	Dimensions in Inches (mm)			
	Male Thread A	Female Thread B		T	H	D	W
				Thread Length	Height	Outer Diameter	Wrench Flat
RR-1612-GY	M16 x 1.5	M12 x 1.5	B	.35 (9)	1.06 (27)	.87 (22)	.79 (20)
RR-2016-GY	M20 x 1.5	M16 x 1.5	B	.35 (9)	1.06 (27)	1.06 (27)	.94 (24)
RR-2520-GY	M25 x 1.5	M20 x 1.5	A	.39 (10)	.67 (17)	1.26 (32)	1.14 (29)
RR-3225-GY	M32 x 1.5	M25 x 1.5	A	.47 (12)	.75 (19)	1.57 (40)	1.42 (36)
RR-4032-GY	M40 x 1.5	M32 x 1.5	A	.47 (12)	.75 (19)	2.01 (51)	1.81 (46)
RR-5040-GY	M50 x 1.5	M40 x 1.5	A	.55 (14)	.83 (21)	2.40 (61)	2.17 (55)
RR-6350-GY	M63 x 1.5	M50 x 1.5	A	.59 (15)	.87 (22)	2.95 (75)	2.68 (68)

Operating Temperature: (Nylon Reducers): -40 °F to 176 °F (-40 °C to 80 °C)



Type C

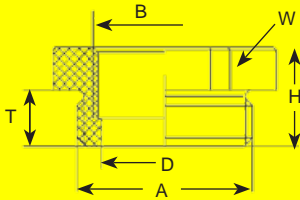

Black Nylon - Thread Reducers: Metric to Metric Threads*							
Part Numbers	Threads		Adapter Type	Dimensions in Inches (mm)			
	Male Thread A	Female Thread B		T	H	D	W
				Thread Length	Height	Inner Diameter	Wrench Flat
RM-1612-BK	M16 x 1.5	M12 x 1.5	C	.31 (8)	.55 (14)	.39 (10)	.79 (20)
RM-2016-BK	M20 x 1.5	M16 x 1.5	C	.31 (8)	.55 (14)	.53 (13.5)	.98 (25)
RM-2520-BK	M25 x 1.5	M20 x 1.5	C	.31 (8)	.55 (14)	.71 (18)	1.14 (29)
RM-3225-BK	M32 x 1.5	M25 x 1.5	C	.39 (10)	.63 (16)	.91 (23)	1.42 (36)
RM-4032-BK	M40 x 1.5	M32 x 1.5	D	.59 (15)	.79 (20)	1.18 (30)	N/A
RM-5040-BK	M50 x 1.5	M40 x 1.5	D	.59 (15)	.79 (20)	1.50 (38)	N/A
RM-6350-BK	M63 x 1.5	M50 x 1.5	D	.59 (15)	.79 (20)	1.89 (48)	N/A



Type D

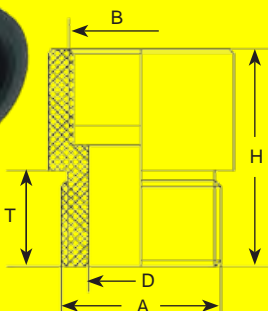



Black Polypropylene - Thread Reducers: NPT to NPT Threads*						
Part Numbers	Threads		Adapter Type	Dimensions in Inches (mm)		
	Male Thread A	Female Thread B		T	H	D
				Thread Length	Height	Inner Diameter
RB-3412-02	3/4" NPT	1/2" NPT	C	.64 (16.2)	.89 (22.5)	.70 (17.7)
RB-3438-02	3/4" NPT	3/8" NPT	C	.63 (15.9)	.88 (22.2)	.70 (17.7)
RB-1012-02	1" NPT	1/2" NPT	C	.65 (16.5)	.90 (22.9)	.91 (23.1)
RB-1034-02	1" NPT	3/4" NPT	C	.65 (16.5)	.90 (22.9)	.92 (23.4)
RB-1214-02	1/2" NPT	1/4" NPT	C	.57 (14.4)	.81 (20.7)	.56 (14.2)
RB-1238-02	1/2" NPT	3/8" NPT	C	.57 (14.6)	.82 (20.9)	.56 (14.2)

*Note: O-Ring not Included
 See page 49 for thread specifications.

Accessories - Thread Reducers (303) Stainless Steel (Hex) - PG/Metric Threads



Nickel Plated Brass Thread Reducers: Metric to Metric Threads						
Part Numbers		Threads		Dimensions in Inches (mm)		
-4 °F to 203 °F (-20 °C to 95 °C)		Male Thread A	Female Thread B	W	T	H
				Wrench Flat	Thread Length	Height
RM-1612-SS	RM-1612-SS-B	M16 x 1.5	M12 x 1.5	.67 (17)	.20 (5)	.35 (9)
RM-2012-SS	RM-2012-SS-B	M20 x 1.5	M12 x 1.5	.87 (22)	.24 (6)	.37 (9.5)
RM-2016-SS	RM-2016-SS-B	M20 x 1.5	M16 x 1.5	.87 (22)	.24 (6)	.37 (9.5)
RM-2516-SS	RM-2516-SS-B	M25 x 1.5	M16 x 1.5	1.06 (27)	.28 (7)	.41 (10.5)
RM-2520-SS	RM-2520-SS-B	M25 x 1.5	M20 x 1.5	1.06 (27)	.28 (7)	.41 (10.5)
RM-3216-SS	RM-3216-SS-B	M32 x 1.5	M16 x 1.5	1.34 (34)	.31 (8)	.49 (12.5)
RM-3220-SS	RM-3220-SS-B	M32 x 1.5	M20 x 1.5	1.34 (34)	.31 (8)	.49 (12.5)
RM-3225-SS	RM-3225-SS-B	M32 x 1.5	M25 x 1.5	1.34 (34)	.31 (8)	.49 (12.5)
RM-4020-SS	RM-4020-SS-B	M40 x 1.5	M20 x 1.5	1.46 (43)	.31 (8)	.51 (13)
RM-4025-SS	RM-4025-SS-B	M40 x 1.5	M25 x 1.5	1.46 (43)	.31 (8)	.51 (13)
RM-4032-SS	RM-4032-SS-B	M40 x 1.5	M32 x 1.5	1.46 (43)	.31 (8)	.51 (13)
RM-5025-SS	RM-5025-SS-B	M50 x 1.5	M25 x 1.5	2.17 (55)	.35 (9)	.59 (15)
RM-5032-SS	RM-5032-SS-B	M50 x 1.5	M32 x 1.5	2.17 (55)	.35 (9)	.59 (15)
RM-5040-SS	RM-5040-SS-B	M50 x 1.5	M40 x 1.5	2.17 (55)	.35 (9)	.59 (15)
RM-6332-SS	RM-6332-SS-B	M63 x 1.5	M32 x 1.5	2.56 (65)	.39 (10)	.65 (16.5)
RM-6340-SS	RM-6340-SS-B	M63 x 1.5	M40 x 1.5	2.56 (65)	.39 (10)	.65 (16.5)
RM-6350-SS	RM-6350-SS-B	M63 x 1.5	M50 x 1.5	2.56 (65)	.39 (10)	.65 (16.5)

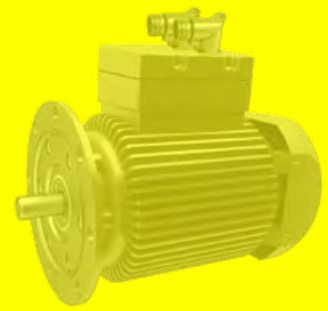

The 316L material is much harder and ideal for direct exposure to salt water and chemical solutions in marine, off-shore, pharmaceutical, etc.



316L Stainless Steel Reducers are produced upon request only.

Please allow for longer delivery times!

Adapter, Reducer & Enlarger Applications:

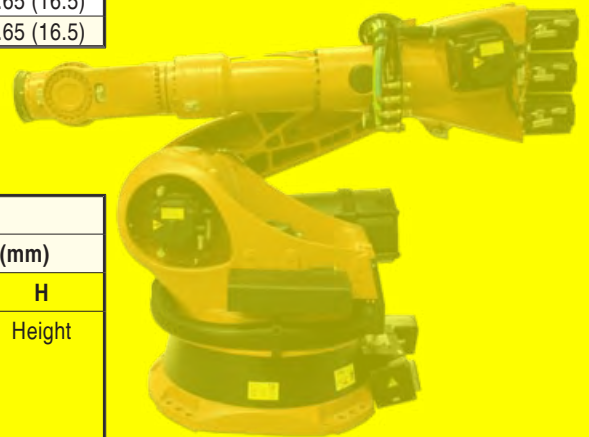
- International machine builder & equipment
- Import / Export oriented projects
- Adapting to domestic markets



Nickel Plated Brass Thread Reducers: PG to PG Threads						
Part Numbers		Threads		Dimensions in Inches (mm)		
-4 °F to 203 °F (-20 °C to 95 °C)		Male Thread A	Female Thread B	W	T	H
				Wrench Flat	Thread Length	Height
RP-0907-SS	RQ-0907-SS	PG 9	PG 7	.67 (17)	.24 (6)	.34 (8.8)
RP-1107-SS	RQ-1107-SS	PG 11	PG 7	.87 (22)	.24 (6)	.35 (9)
RP-1109-SS	RQ-1109-SS	PG 11	PG 9	.87 (22)	.24 (6)	.35 (9)
RP-1309-SS	RQ-1309-SS	PG 13 / 13.5	PG 9	.87 (22)	.26 (6.5)	.37 (9.5)
RP-1311-SS	RQ-1311-SS	PG 13 / 13.5	PG 11	.87 (22)	.26 (6.5)	.37 (9.5)
RP-1609-SS	RQ-1609-SS	PG 16	PG 9	.94 (24)	.26 (6.5)	.37 (9.5)
RP-1611-SS	RQ-1611-SS	PG 16	PG 11	.94 (24)	.26 (6.5)	.37 (9.5)
RP-1613-SS	RQ-1613-SS	PG 16	PG 13 / 13.5	.94 (24)	.26 (6.5)	.37 (9.5)
RP-2111-SS	RQ-2111-SS	PG 21	PG 11	1.18 (30)	.28 (7)	.41 (10.3)
RP-2113-SS	RQ-2113-SS	PG 21	PG 13 / 13.5	1.18 (30)	.28 (7)	.41 (10.3)
RP-2116-SS	RQ-2116-SS	PG 21	PG 16	1.18 (30)	.28 (7)	.41 (10.3)
RP-2916-SS	RQ-2916-SS	PG 29	PG 16	1.57 (40)	.31 (8)	.45 (11.5)
RP-2921-SS	RQ-2921-SS	PG 29	PG 21	1.57 (40)	.31 (8)	.45 (11.5)
RP-3621-SS	RQ-3621-SS	PG 36	PG 21	1.97 (50)	.35 (9)	.49 (12.5)
RP-3629-SS	RQ-3629-SS	PG 36	PG 29	1.97 (50)	.35 (9)	.49 (12.5)
RP-4229-SS	RQ-4229-SS	PG 42	PG 29	2.24 (57)	.39 (10)	.53 (13.5)
RP-4236-SS	RQ-4236-SS	PG 42	PG 36	2.24 (57)	.39 (10)	.53 (13.5)
RP-4836-SS	RQ-4836-SS	PG 48	PG 36	2.52 (64)	.39 (10)	.53 (13.5)
RP-4842-SS	RQ-4842-SS	PG 48	PG 42	2.52 (64)	.39 (10)	.53 (13.5)

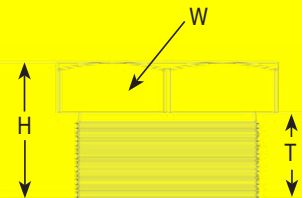

Also available with the following approvals:



For inquiries - Please call our Inside Technical Sales Department (410)358-3130 (800)638-1830.

More custom parts available online at www.6mm.com or upon request!

Accessories - Thread Enlargers - Nylon & Nickel Plated Brass - (Hex) - PG/Metric Threads



Type A

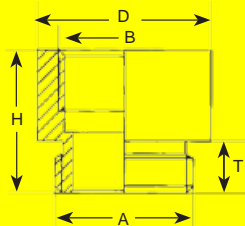
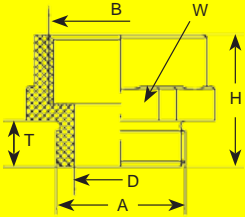

Type C

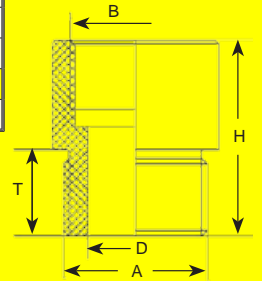

Black Nylon - Thread Enlargers: Metric to Metric Threads*							
Part Numbers	Threads		Adapter Type	Dimensions in Inches (mm)			
	Male Thread A	Female Thread B		T	H	D	W
				Thread Length	Height	Inner Diameter	Wrench Flat
EM-1216-BK	M12 x 1.5	M16 x 1.5	A	.31 (8)	.79 (20)	.26 (6.5)	.83 (21)
EM-1620-BK	M16 x 1.5	M20 x 1.5	A	.31 (8)	.83 (21)	.35 (9)	.98 (25)
EM-2025-BK	M20 x 1.5	M25 x 1.5	A	.31 (8)	.91 (23)	.55 (14)	1.18 (30)
EM-2532-BK	M25 x 1.5	M32 x 1.5	C	.59 (15)	1.18 (30)	.65 (16.5)	N/A
EM-3240-BK	M32 x 1.5	M40 x 1.5	C	.59 (15)	1.36 (34.5)	.91 (23)	N/A
EM-4050-BK	M40 x 1.5	M50 x 1.5	C	.59 (15)	1.36 (34.5)	1.18 (30)	N/A
EM-5063-BK	M50 x 1.5	M63 x 1.5	C	.59 (15)	1.38 (35)	1.54 (39)	N/A

Operating Temperature (Nylon Enlargers): -40 °C to 100 °C (-40 °F to 212 °F)

Nickel Plated Brass - Thread Enlargers: PG to PG Threads*					
Part Numbers	Threads		Dimensions in Inches (mm)		
	Male Thread A	Female Thread B	D	T	H
			Outer Diameter	Thread Length	Height
EP-0709-BR	PG 7	PG 9	.67 (17)	.20 (5)	.59 (15)
EP-0911-BR	PG 9	PG 11	.79 (20)	.24 (6)	.65 (16.5)
EP-0913-BR	PG 9	PG 13 / 13.5	.87 (22)	.24 (6)	.69 (17.5)
EP-1113-BR	PG 11	PG 13 / 13.5	.87 (22)	.24 (6)	.69 (17.5)
EP-1116-BR	PG 11	PG 16	.94 (24)	.24 (6)	.73 (18.5)
EP-1121-BR	PG 11	PG 21	1.18 (30)	.24 (6)	.81 (20.5)
EP-1316-BR	PG 13 / 13.5	PG 16	.94 (24)	.26 (6.5)	.75 (19)
EP-1321-BR	PG 13 / 13.5	PG 21	1.18 (30)	.26 (6.5)	.83 (21)
EP-1621-BR	PG 16	PG 21	1.18 (30)	.26 (6.5)	.83 (21)
EP-1629-BR	PG 16	PG 29	1.54 (39)	.26 (6.5)	.88 (22.5)
EP-2129-BR	PG 21	PG 29	1.54 (39)	.28 (7)	.91 (23)
EP-2936-BR	PG 29	PG 36	1.97 (50)	.31 (8)	1.08 (27.5)
EP-3642-BR	PG 36	PG 42	2.24 (57)	.35 (9)	1.22 (31)
EP-4248-BR	PG 42	PG 48	2.52 (64)	.39 (10)	1.30 (33)

Is your thread size off by one size?

These Enlargers will solve that threading problem.

They convert holes which fit PG, NPT or Metric threads to a larger female thread of the same thread type.

Nickel Plated Brass - Thread Enlargers: Metric to Metric Threads*					
Part Numbers	Threads		Dimensions in Inches (mm)		
	Male Thread A	Female Thread B	D	T	H
			Outer Diameter	Thread Length	Height
EM-1216-BR	M12 x 1.5	M16 x 1.5	.71 (18)	.20 (5)	.59 (15)
EM-1620-BR	M16 x 1.5	M20 x 1.5	.87 (22)	.24 (6)	.69 (17.5)
EM-2025-BR	M20 x 1.5	M25 x 1.5	1.06 (27)	.26 (6.5)	.75 (19)
EM-2532-BR	M25 x 1.5	M32 x 1.5	1.34 (34)	.26 (6.5)	.83 (21)
EM-3240-BR	M32 x 1.5	M40 x 1.5	1.65 (42)	.28 (7)	.91 (23)
EM-4050-BR	M40 x 1.5	M50 x 1.5	2.09 (53)	.35 (9)	1.22 (31)
EM-5063-BR	M50 x 1.5	M63 x 1.5	2.60 (66)	.35 (9)	1.22 (31)

More custom parts available online at www.6mm.com or upon request!

Nickel Plated Brass - Thread Enlargers: NPT to NPT Threads*					
Part Numbers	Threads		Dimensions in Inches (mm)		
	Male Thread A	Female Thread B	D	T	H
			Outer Diameter	Thread Length	Height
EN-3812-BR	3/8" NPT	1/2" NPT	1.10 (28)	.59 (15)	1.50 (38)
EN-1234-BR	1/2" NPT	3/4" NPT	1.10 (28)	.79 (20)	1.50 (38)
EN-1210-BR	1/2" NPT	1" NPT	1.36 (34.5)	.79 (20)	1.75 (44.5)
EN-3410-BR	3/4" NPT	1" NPT	1.38 (35)	.71 (18)	1.69 (43)
EN-1054-BR	1" NPT	1-1/4" NPT	1.73(44)	.94 (24)	1.97 (50)



Optional Locking Nuts, O-Rings & Other Accessories starting on Page 28 - 39.

*Note: O-Ring not Included
 See page 49 for thread specifications.

Operating Temperature (Nickel Plated Brass Enlargers): -40 °C to 100 °C (-40 °F to 212 °F)

Maryland Metrics R955 Series: Accessories for Strain Relief Fittings Supplemental Summary



Large Hex Nuts
 Nickel Plated Brass

Page 45S

Page 45S
 Plugs Page 45



Hex Hole Plugs
 Nylon & Nickel Plated Brass

Page 46-47S

Page 48-50S
 PG Page 48-50



Seal Ring
 Red Fiber Washer

Page 51S

Page 51S
 Tags Page 51



Washers
 Serrated Washers

Page 51S

Page 51S
 Sleeve



Hole Plugs
 Mushroom Hole

Thread Reducers
 Metric &



Earth Tags
 Grounding



Shroud
 Protective

Nickel Plated Brass: Locking Nuts			
Part Numbers	Thread Type & Size	Dimensions in Inches (mm)	
		G	H
-40 °F to 212 °F (-40 °C to 100 °C)	 See page 49 for thread specs	Thickness	Wrench Flats
NM-63-XL	M63 x 1.5	.24 (6)	2.76 (70)
NM-75-XL	M75 x 1.5	.32 (8)	3.35 (85)
NM-80-XL	M80 x 2	.32 (8)	3.54 (90)

Large Hex Nuts Nickel Plated Brass

NM-90-XL	M90 x 2	.32 (8)	3.94 (100)
NM-10-XL	M100 x 2	.43 (11)	4.53 (115)
NM-11-XL	M110 x 2	.43 (11)	4.92 (125)
NG-52-XL	G 2-1/2"	.28 (7)	3.15 (80)
NG-30-XL	G 3"	.32 (8)	3.74 (95)
NG-40-XL	G 4"	.43 (11)	4.92 (125)

Ex-e Accessories - Mushroom Hole Plug Elastomer - NPT, Metric & PG Sizes



Hole Plug: Mushroom - NPT/Metric & PG Threads						
Part Numbers	Thread Type & Size	Dimensions in Inches (mm)				
		A	D	H	W	
 (Mushroom Plug)		Plug Diameter	Dome Height	Overall Height	Dome Width	
PV-07-BX	PG 7 / M12 x 1,5	.25 (6.3)	.18 (4.5)	.45 (11.5)	.37 (9.5)	
PV-09-BX	PG 9 / M16 x 1.5 / 3/8" NPT	.31 (7.8)	.22 (5.5)	.53 (13.5)	.43 (11)	
PV-11-BX	PG 11	.39 (9.8)	.22 (5.5)	.57 (14.5)	.53 (13.5)	
PV-13-BX	PG 13 / M20 x 1.5 / 1/2" NPT	.46 (11.8)	.32 (8)	.71 (18)	.63 (16)	
PV-16-BX	PG 16 / 1/2" NPT	.54 (13.8)	.35 (9)	.75 (19)	.73 (18.5)	
PV-21-BX	PG 21 / M25 x 1.5 / 3/4" NPT	.70 (17.8)	.43 (11)	.87 (22)	.87 (22)	
PV-29-BX	PG 29 / M32 x 1.5 / 1" NPT / 1 1/4" NPT	.98 (25)	.39 (10)	.98 (25)	1.14 (29)	
PV-36-BX	PG 36 / M40 x 1.5 / 1 1/4" NPT	1.26 (32)	.43 (11)	1.10 (28)	1.50 (38)	
PV-42-BX	PG 42 / M50 x 1.5	1.50 (38)	.47 (12)	1.18 (30)	1.69 (43)	
PV-48-BX	PG 48 / M63 x 1.5	1.73 (44)	.47 (12)	1.18 (30)	1.93 (49)	

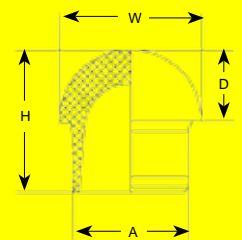



Ex-e Accessories - Hex Plugs Nylon & Nickel Plated Brass - Metric & PG Sizes

Hex Plugs: Nylon w/ Buna-N O-Ring - Metric & PG Threads						
Part Numbers	Thread Type & Size	Dimensions in Inches (mm)				
		H	D	T	X	
-4°F to 194°F (-20°C to 90°C)	Page 55 for Thread Specs	Overall Height	Overall Width	Thread Length	Wrench Flat	Allen Wrench Size
 Black Nylon						
HM-12-BX	M12 x 1.5	.51 (13)	.65 (16.5)	.33 (8.5)	.59 (15)	.24 (6)
HM-16-BX	M16 x 1.5	.51 (13)	.81 (20.5)	.33 (8.5)	.75 (19)	.31 (8)
HM-20-BX	M20 x 1.5	.57 (14.5)	1.00 (25.5)	.35 (9)	.94 (24)	.31 (8)
HM-25-BX	M25 x 1.5	.63 (16)	1.20 (30.5)	.41 (10.5)	1.10 (28)	.31 (8)
HM-32-BX	M32 x 1.5	.69 (17.5)	1.50 (38)	.45 (11.5)	1.42 (36)	.31 (8)
HM-40-BX	M40 x 1.5	.71 (18)	1.89 (48)	.45 (11.5)	1.81 (46)	.31 (8)
HM-50-BX	M50 x 1.5	.79 (20)	2.36 (60)	.53 (13.5)	2.17 (55)	.31 (8)
HM-63-BX	M63 x 1.5	.83 (21)	2.95 (75)	.57 (14.5)	2.76 (70)	.31 (8)
HP-07-BX	PG 7 / 1/4" NPT	.51 (13)	.65 (16.5)	.33 (8.5)	.59 (15)	.24 (6)
HP-09-BX	PG 9	.51 (13)	.81 (20.5)	.33 (8.5)	.75 (19)	.31 (8)
HP-11-BX	PG 11	.57 (14.5)	.81 (20.5)	.35 (9)	.94 (24)	.31 (8)
HP-13-BX	PG 13 / 13.5	.57 (14.5)	1.00 (25.5)	.35 (9)	.94 (24)	.31 (8)
HP-16-BX	PG 16	.63 (16)	1.20 (30.5)	.41 (10.5)	1.10 (28)	.31 (8)
HP-21-BX	PG 21	.69 (17.5)	1.50 (38)	.45 (11.5)	1.42 (36)	.31 (8)
HP-29-BX	PG 29	.71 (18)	1.89 (48)	.45 (11.5)	1.81 (46)	.31 (8)
HP-36-BX	PG 36	.79 (20)	2.36 (60)	.53 (13.5)	2.17 (55)	.31 (8)
HP-42-BX	PG 42	.79 (20)	2.56 (65)	.53 (13.5)	2.36 (60)	.31 (8)
HP-48-BX	PG 48	.83 (21)	2.95 (75)	.57 (14.5)	2.76 (70)	.31 (8)

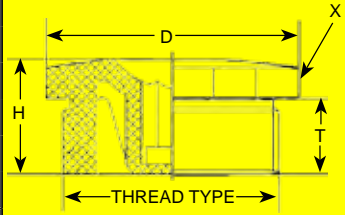

Note: HP & HM Nylon Plugs can be tightened with Hex & Allen wrenches, as well as regular screwdrivers.

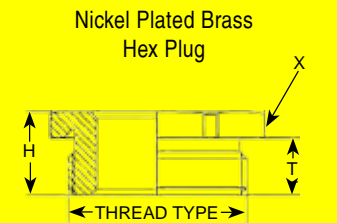

Hex Plugs: Nickel Plated Brass - Metric & PG Threads						
Part Numbers			Thread Type & Size	Dimensions in Inches (mm)		
-4°F to 203°F (-20°C to 95°C)	-4°F to 356°F (-20°C to 180°C)	-46°F to 356°F (-60°C to 180°C)		H	T	X
 Buna-N	 Viton®	 Silicone	Page 55 for Thread Specs	Overall Height	Thread Length	Wrench Flat
HM-12-MX	HM-12-MX-V	HM-12-MX-S		M12 x 1.5	.37 (9.5)	.26 (6.5)
HM-16-MX	HM-16-MX-V	HM-16-MX-S	M16 x 1.5	.35 (9)	.24 (6)	.75 (19)
HM-20-MX	HM-20-MX-V	HM-20-MX-S	M20 x 1.5	.37 (9.5)	.24 (6)	.87 (22)
HM-25-MX	HM-25-MX-V	HM-25-MX-S	M25 x 1.5	.41 (10.5)	.28 (7)	1.18 (30)
HM-32-MX	HM-32-MX-V	HM-32-MX-S	M32 x 1.5	.49 (12.5)	.31 (8)	1.61 (41)
HM-40-MX	HM-40-MX-V	HM-40-MX-S	M40 x 1.5	.51 (13)	.31 (8)	1.81 (46)
HM-50-MX	HM-50-MX-V	HM-50-MX-S	M50 x 1.5	.59 (15)	.35 (9)	2.17 (55)
HM-63-MX	HM-63-MX-V	HM-63-MX-S	M63 x 1.5	.65 (16.5)	.39 (10)	2.76 (70)
HP-07-MX	HP-07-MX-V	HP-07-MX-S	PG 7 / 1/4" NPT	.31 (8)	.20 (5)	.55 (14)
HP-09-MX	HP-09-MX-V	HP-09-MX-S	PG 9	.35 (9)	.24 (6)	.67 (17)
HP-11-MX	HP-11-MX-V	HP-11-MX-S	PG 11	.37 (9.5)	.24 (6)	.79 (20)
HP-13-MX	HP-13-MX-V	HP-13-MX-S	PG 13.5	.39 (10)	.26 (6.5)	.87 (22)
HP-16-MX	HP-16-MX-V	HP-16-MX-S	PG 16	.39 (10)	.26 (6.5)	.94 (24)
HP-21-MX	HP-21-MX-V	HP-21-MX-S	PG 21	.41 (10.5)	.28 (7)	1.18 (30)
HP-29-MX	HP-29-MX-V	HP-29-MX-S	PG 29	.49 (12.5)	.31 (8)	1.61 (41)
HP-36-MX	HP-36-MX-V	HP-36-MX-S	PG 36	.51 (13)	.31 (8)	1.97 (50)
HP-42-MX	HP-42-MX-V	HP-42-MX-S	PG 42	.59 (15)	.35 (9)	2.28 (58)
HP-48-MX	HP-48-MX-V	HP-48-MX-S	PG 48	.65 (16.5)	.39 (10)	2.56 (65)

Also Available:

Nickel Plated Brass Hex Plug are also available in Ex-d versions in Metric Threads.



Please use the following part numbers below when the extra approval are required!

Part Numbers	O-Rings
HM-xx-MX-D	Buna-N
HM-xx-MVX-D	Viton®
HM-xx-MIX-D	Sili-cone

Viton® is a federally registered trademark of DuPont Dow Elastomer.



Ex-e Accessories - Hex Plugs Stainless Steel (303) - Metric & PG Sizes

Hex Plugs: Stainless Steel (303) - Metric & PG Threads						
Part Numbers			Thread Type & Size	Dimensions in Inches (mm)		
-4°F to 203°F (-20°C to 95°C)	-4°F to 356°F (-20°C to 180°C)	-46°F to 356°F (-60°C to 180°C)		H	T	X
 Buna-N Viton® Silicone			Page 55 for Thread Specs	Overall Height	Thread Length	Wrench Flat
HM-12-SX	HM-12-SX-V	HM-12-SX-S	M12 x 1.5	.37 (9.5)	.26 (6.5)	.55 (14)
HM-16-SX	HM-16-SX-V	HM-16-SX-S	M16 x 1.5	.35 (9)	.24 (6)	.75 (19)
HM-20-SX	HM-20-SX-V	HM-20-SX-S	M20 x 1.5	.37 (9.5)	.24 (6)	.87 (22)
HM-25-SX	HM-25-SX-V	HM-25-SX-S	M25 x 1.5	.41 (10.5)	.28 (7)	1.18 (30)
HM-32-SX	HM-32-SX-V	HM-32-SX-S	M32 x 1.5	.49 (12.5)	.31 (8)	1.61 (41)
HM-40-SX	HM-40-SX-V	HM-40-SX-S	M40 x 1.5	.51 (13)	.31 (8)	1.81 (46)
HM-50-SX	HM-50-SX-V	HM-50-SX-S	M50 x 1.5	.59 (15)	.35 (9)	2.17 (55)
HM-63-SX	HM-63-SX-V	HM-63-SX-S	M63 x 1.5	.65 (16.5)	.39 (10)	2.76 (70)
HP-07-SX	HP-07-SX-V	HP-07-SX-S	PG 7 / 1/4"NPT	.31 (8)	.20 (5)	.55 (14)
HP-09-SX	HP-09-SX-V	HP-09-SX-S	PG 9	.35 (9)	.24 (6)	.67 (17)
HP-11-SX	HP-11-SX-V	HP-11-SX-S	PG 11	.37 (9.5)	.24 (6)	.79 (20)
HP-13-SX	HP-13-SX-V	HP-13-SX-S	PG 13.5	.39 (10)	.26 (6.5)	.87 (22)
HP-16-SX	HP-16-SX-V	HP-16-SX-S	PG 16	.39 (10)	.26 (6.5)	.94 (24)
HP-21-SX	HP-21-SX-V	HP-21-SX-S	PG 21	.41 (10.5)	.28 (7)	1.18 (30)
HP-29-SX	HP-29-SX-V	HP-29-SX-S	PG 29	.49 (12.5)	.31 (8)	1.61 (41)
HP-36-SX	HP-36-SX-V	HP-36-SX-S	PG 36	.51 (13)	.31 (8)	1.97 (50)
HP-42-SX	HP-42-SX-V	HP-42-SX-S	PG 42	.59 (15)	.35 (9)	2.28 (58)
HP-48-SX	HP-48-SX-V	HP-48-SX-S	PG 48	.65 (16.5)	.39 (10)	2.56 (65)

Viton® is a federally registered trademark of DuPont Dow Elastomer.



Ex-d Accessories - Hex Plugs Stainless Steel (316) - Metric Threads

Hex Plugs: Stainless Steel (316) - Metric Threads						
Part Numbers			Thread Type & Size	Dimensions in Inches (mm)		
-4°F to 203°F (-20°C to 95°C)	-4°F to 356°F (-20°C to 180°C)	-46°F to 356°F (-60°C to 180°C)		H	T	X
 Buna-N Viton Silicone			Page 55 for Thread Specs	Overall Height	Thread Length	Wrench Flat
HM-12-6X-D	HM-12-6VX-D	HM-12-6IX-D	M12 x 1.5	.59 (15)	.47 (12)	.55 (14)
HM-16-6X-D	HM-16-6VX-D	HM-16-6IX-D	M16 x 1.5	.59 (15)	.47 (12)	.75 (19)
HM-20-6X-D	HM-20-6VX-D	HM-20-6IX-D	M20 x 1.5	.61 (15.5)	.47 (12)	.87 (22)
HM-25-6X-D	HM-25-6VX-D	HM-25-6IX-D	M25 x 1.5	.61 (15.5)	.47 (12)	1.18 (30)
HM-32-6X-D	HM-32-6VX-D	HM-32-6IX-D	M32 x 1.5	.65 (16.5)	.47 (12)	1.61 (41)
HM-40-6X-D	HM-40-6VX-D	HM-40-6IX-D	M40 x 1.5	.67 (17)	.47 (12)	1.81 (46)
HM-50-6X-D	HM-50-6VX-D	HM-50-6IX-D	M50 x 1.5	.71 (18)	.47 (12)	2.17 (55)
HM-63-6X-D	HM-63-6VX-D	HM-63-6IX-D	M63 x 1.5	.65 (16.5)	.39 (10)	2.76 (70)



Viton® is a federally registered trademark of DuPont Dow Elastomer.



RoHS Dimensions, specifications and certifications may be changed without prior notice. BDE





Ex-e Accessories - Thread Reducers Nickel Plated Brass - Metc & PG Threads

Thread Reducers: Nickel Plated Brass - Metric & PG Threads						
Part Numbers		Thread Type & Size		Dimensions in Inches (mm)		
-4°F to 203°F (-20°C to 95°C)	-76°F to 356°F (-60°C to 180°C)	Male Thread A	Female Thread B	H	T	X
		Page 55 for Thread Specs	Page 55 for Thread Specs	Overall Height	Thread Length	Wrench Flat
w/ Buna-N O-Ring	w/ Silicone O-Ring					
RM-1612-MX	RM-1612-MX-S	M16 x 1.5	M12 x 1.5	.31" (8)	.20" (5)	.67" (17)
RM-2012-MX	RM-2012-MX-S	M20 x 1.5	M12 x 1.5	.35" (9)	.24" (6)	.87" (22)
RM-2016-MX	RM-2016-MX-S	M20 x 1.5	M16 x 1.5	.35" (9)	.24" (6)	.87" (22)
RM-2516-MX	RM-2516-MX-S	M25 x 1.5	M16 x 1.5	.39" (10)	.28" (7)	1.06" (27)
RM-2520-MX	RM-2520-MX-S	M25 x 1.5	M20 x 1.5	.39" (10)	.28" (7)	1.06" (27)
RM-3216-MX	RM-3216-MX-S	M32 x 1.5	M16 x 1.5	.43" (11)	.31" (8)	1.34" (34)
RM-3220-MX	RM-3220-MX-S	M32 x 1.5	M20 x 1.5	.43" (11)	.31" (8)	1.34" (34)
RM-3225-MX	RM-3225-MX-S	M32 x 1.5	M25 x 1.5	.43" (11)	.31" (8)	1.34" (34)
RM-4020-MX	RM-4020-MX-S	M40 x 1.5	M20 x 1.5	.47" (12)	.31" (8)	1.69" (43)
RM-4025-MX	RM-4025-MX-S	M40 x 1.5	M25 x 1.5	.47" (12)	.31" (8)	1.69" (43)
RM-4032-MX	RM-4032-MX-S	M40 x 1.5	M32 x 1.5	.47" (12)	.31" (8)	1.69" (43)
RM-5025-MX	RM-5025-MX-S	M50 x 1.5	M25 x 1.5	.51" (13)	.35" (9)	2.17" (55)
RM-5032-MX	RM-5032-MX-S	M50 x 1.5	M32 x 1.5	.51" (13)	.35" (9)	2.17" (55)
RM-5040-MX	RM-5040-MX-S	M50 x 1.5	M40 x 1.5	.51" (13)	.35" (9)	2.17" (55)
RM-6332-MX	RM-6332-MX-S	M63 x 1.5	M32 x 1.5	.55" (14)	.39" (10)	2.56" (65)
RM-6340-MX	RM-6340-MX-S	M63 x 1.5	M40 x 1.5	.55" (14)	.39" (10)	2.56" (65)
RM-6350-MX	RM-6350-MX-S	M63 x 1.5	M50 x 1.5	.55" (14)	.39" (10)	2.56" (65)
RQ-0907-MX	RQ-0907-MX-S	PG 9	PG 7	.35" (8.8)	.24" (6)	.67" (17)
RQ-1107-MX	RQ-1107-MX-S	PG 11	PG 7	.35" (9)	.24" (6)	.79" (20)
RQ-1109-MX	RQ-1109-MX-S	PG 11	PG 9	.35" (9)	.24" (6)	.79" (20)
RQ-1309-MX	RQ-1309-MX-S	PG13	PG 9	.37" (9.5)	.26" (6.5)	.87" (22)
RQ-1609-MX	RQ-1609-MX-S	PG 16	PG 9	.37" (9.5)	.26" (6.5)	.94" (24)
RQ-1611-MX	RQ-1611-MX-S	PG 16	PG 11	.37" (9.5)	.26" (6.5)	.94" (24)
RQ-1613-MX	RQ-1613-MX-S	PG 16	PG 13	.37" (9.5)	.26" (6.5)	.94" (24)
RQ-2111-MX	RQ-2111-MX-S	PG 21	PG 11	.41" (10.3)	.28" (7)	1.18" (30)
RQ-2113-MX	RQ-2113-MX-S	PG 21	PG 13	.41" (10.3)	.28" (7)	1.18" (30)
RQ-2116-MX	RQ-2116-MX-S	PG 21	PG 16	.41" (10.3)	.28" (7)	1.18" (30)
RQ-2916-MX	RQ-2916-MX-S	PG 29	PG 16	.45" (11.5)	.31" (8)	1.57" (40)
RQ-2921-MX	RQ-2921-MX-S	PG 29	PG 21	.45" (11.5)	.31" (8)	1.57" (40)
RQ-3621-MX	RQ-3621-MX-S	PG 36	PG 21	.49" (12.5)	.35" (9)	1.97" (50)
RQ-3629-MX	RQ-3629-MX-S	PG 36	PG 29	.49" (12.5)	.35" (9)	1.97" (50)
RQ-4229-MX	RQ-4229-MX-S	PG 42	PG 29	.53" (13.5)	.39" (10)	2.24" (57)
RQ-4236-MX	RQ-4236-MX-S	PG 42	PG 36	.53" (13.5)	.39" (10)	2.24" (57)
RQ-4836-MX	RQ-4836-MX-S	PG 48	PG 36	.53" (13.5)	.39" (10)	2.52" (64)
RQ-4842-MX	RQ-4842-MX-S	PG 48	PG 42	.53" (13.5)	.39" (10)	2.52" (64)





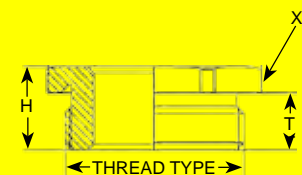

Ex-e Accessories - Thread Reducers Stainless Steel (303) - Metric & PG Threads

Thread Reducers: Stainless Steel (INOX 303) - Metric & PG Threads						
Part Numbers		Thread Type & Size		Dimensions in Inches (mm)		
-4°F to 203°F (-20°C to 95°C)	-76°F to 356°F (-60°C to 180°C)	Male Thread A	Female Thread B	H	T	X
 w/ Buna-N O-Ring	 w/ Silicone O-Ring	Page 55 for Thread Specs	Page 55 for Thread Specs	Overall Height	Thread Length	Wrench Flat
RM-1612-SX	RM-1612-SX-S	M16 x 1.5	M12 x 1.5	.35" (9)	.20" (5)	.67" (17)
RM-2012-SX	RM-2012-SX-S	M20 x 1.5	M12 x 1.5	.37" (9.5)	.24" (6)	.87" (22)
RM-2016-SX	RM-2016-SX-S	M20 x 1.5	M16 x 1.5	.37" (9.5)	.24" (6)	.87" (22)
RM-2516-SX	RM-2516-SX-S	M25 x 1.5	M16 x 1.5	.41" (10.5)	.28" (7)	1.06" (27)
RM-2520-SX	RM-2520-SX-S	M25 x 1.5	M20 x 1.5	.41" (10.5)	.28" (7)	1.06" (27)
RM-3216-SX	RM-3216-SX-S	M32 x 1.5	M16 x 1.5	.49" (12.5)	.31" (8)	1.34" (34)
RM-3220-SX	RM-3220-SX-S	M32 x 1.5	M20 x 1.5	.49" (12.5)	.31" (8)	1.34" (34)
RM-3225-SX	RM-3225-SX-S	M32 x 1.5	M25 x 1.5	.49" (12.5)	.31" (8)	1.34" (34)
RM-4020-SX	RM-4020-SX-S	M40 x 1.5	M20 x 1.5	.51" (13)	.31" (8)	1.69" (43)
RM-4025-SX	RM-4025-SX-S	M40 x 1.5	M25 x 1.5	.51" (13)	.31" (8)	1.69" (43)
RM-4032-SX	RM-4032-SX-S	M40 x 1.5	M32 x 1.5	.51" (13)	.31" (8)	1.69" (43)
RM-5025-SX	RM-5025-SX-S	M50 x 1.5	M25 x 1.5	.59" (15)	.35" (9)	2.17" (55)
RM-5032-SX	RM-5032-SX-S	M50 x 1.5	M32 x 1.5	.59" (15)	.35" (9)	2.17" (55)
RM-5040-SX	RM-5040-SX-S	M50 x 1.5	M40 x 1.5	.59" (15)	.35" (9)	2.17" (55)
RM-6332-SX	RM-6332-SX-S	M63 x 1.5	M32 x 1.5	.65" (16.5)	.39" (10)	2.56" (65)
RM-6340-SX	RM-6340-SX-S	M63 x 1.5	M40 x 1.5	.65" (16.5)	.39" (10)	2.56" (65)
RM-6350-SX	RM-6350-SX-S	M63 x 1.5	M50 x 1.5	.65" (16.5)	.39" (10)	2.56" (65)
RQ-0907-SX	RQ-0907-SX-S	PG 9	PG 7	.35" (8.8)	.24" (6)	.67" (17)
RQ-1107-SX	RQ-1107-SX-S	PG 11	PG 7	.35" (9)	.24" (6)	.79" (20)
RQ-1109-SX	RQ-1109-SX-S	PG 11	PG 9	.35" (9)	.24" (6)	.79" (20)
RQ-1309-SX	RQ-1309-SX-S	PG13	PG 9	.37" (9.5)	.26" (6.5)	.87" (22)
RQ-1309-SX	RQ-1309-SX-S	PG13	PG 11	.37" (9.5)	.26" (6.5)	.87" (22)
RQ-1609-SX	RQ-1609-SX-S	PG 16	PG 9	.37" (9.5)	.26" (6.5)	.94" (24)
RQ-1611-SX	RQ-1611-SX-S	PG 16	PG 11	.37" (9.5)	.26" (6.5)	.94" (24)
RQ-1613-SX	RQ-1613-SX-S	PG 16	PG 13	.37" (9.5)	.26" (6.5)	.94" (24)
RQ-2111-SX	RQ-2111-SX-S	PG 21	PG 11	.41" (10.3)	.28" (7)	1.18" (30)
RQ-2113-SX	RQ-2113-SX-S	PG 21	PG 13	.41" (10.3)	.28" (7)	1.18" (30)
RQ-2116-SX	RQ-2116-SX-S	PG 21	PG 16	.41" (10.3)	.28" (7)	1.18" (30)
RQ-2916-SX	RQ-2916-SX-S	PG 29	PG 16	.45" (11.5)	.31" (8)	1.57" (40)
RQ-2921-SX	RQ-2921-SX-S	PG 29	PG 21	.45" (11.5)	.31" (8)	1.57" (40)
RQ-3621-SX	RQ-3621-SX-S	PG 36	PG 21	.49" (12.5)	.35" (9)	1.97" (50)
RQ-3629-SX	RQ-3629-SX-S	PG 36	PG 29	.49" (12.5)	.35" (9)	1.97" (50)
RQ-4229-SX	RQ-4229-SX-S	PG 42	PG 29	.53" (13.5)	.39" (10)	2.24" (57)
RQ-4236-SX	RQ-4236-SX-S	PG 42	PG 36	.53" (13.5)	.39" (10)	2.24" (57)
RQ-4836-SX	RQ-4836-SX-S	PG 48	PG 36	.53" (13.5)	.39" (10)	2.52" (64)
RQ-4842-SX	RQ-4842-SX-S	PG 48	PG 42	.53" (13.5)	.39" (10)	2.52" (64)



Ex-d Accessories - Thread Reducers Nickel Plated Brass - Metric Threads



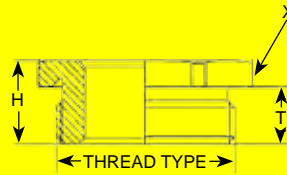

Thread Reducers: Nickel Plated Brass Ex-d - Metric Threads						
Part Numbers		Thread Type & Size		Dimensions in Inches (mm)		
-4°F to 203°F (-20°C to 95°C)	-76°F to 356°F (-60°C to 180°C)	Male Thread A	Female Thread B	H	T	X
		Page 55 for Thread Specs	Page 55 for Thread Specs	Overall Height	Thread Length	Wrench Flat
w/ Buna-N O-Ring	w/ Silicone O-Ring					
RM-1612-MX-D	RM-1612-MIX-D	M16 x 1.5	M12 x 1.5	.59" (15)	.47" (12)	.748" (19)
RM-2012-MX-D	RM-2012-MIX-D	M20 x 1.5	M12 x 1.5	.61" (15.5)	.47" (12)	.87" (22)
RM-2016-MX-D	RM-2016-MIX-D	M20 x 1.5	M16 x 1.5	.61" (15.5)	.47" (12)	.87" (22)
RM-2516-MX-D	RM-2516-MIX-D	M25 x 1.5	M16 x 1.5	.61" (15.5)	.47" (12)	1.18" (30)
RM-2520-MX-D	RM-2520-MIX-D	M25 x 1.5	M20 x 1.5	.61" (15.5)	.47" (12)	1.18" (30)
RM-3216-MX-D	RM-3216-MIX-D	M32 x 1.5	M16 x 1.5	.65" (16.5)	.47" (12)	1.61" (41)
RM-3220-MX-D	RM-3220-MIX-D	M32 x 1.5	M20 x 1.5	.65" (16.5)	.47" (12)	1.61" (41)
RM-3225-MX-D	RM-3225-MIX-D	M32 x 1.5	M25 x 1.5	.65" (16.5)	.47" (12)	1.61" (41)
RM-4020-MX-D	RM-4020-MIX-D	M40 x 1.5	M20 x 1.5	.67" (17)	.47" (12)	1.81" (46)
RM-4025-MX-D	RM-4025-MIX-D	M40 x 1.5	M25 x 1.5	.67" (17)	.47" (12)	1.81" (46)
RM-4032-MX-D	RM-4032-MIX-D	M40 x 1.5	M32 x 1.5	.67" (17)	.47" (12)	1.81" (46)



Ex-d Accessories - Thread Reducers Stainless Steel (303) - Metric Threads



Thread Reducers: Stainless Steel (INOX 316) Ex-d - Metric Threads						
Part Numbers		Thread Type & Size		Dimensions in Inches (mm)		
-4°F to 203°F (-20°C to 95°C)	-76°F to 356°F (-60°C to 180°C)	Male Thread A	Female Thread B	H	T	X
		Page 55 for Thread Specs	Page 55 for Thread Specs	Overall Height	Thread Length	Wrench Flat
w/ Buna-N O-Ring	w/ Silicone O-Ring					
RM-1612-6X-D	RM-1612-6IX-D	M16 x 1.5	M12 x 1.5	.59" (15)	.47" (12)	.748" (19)
RM-2012-6X-D	RM-2012-6IX-D	M20 x 1.5	M12 x 1.5	.61" (15.5)	.47" (12)	.87" (22)
RM-2016-6X-D	RM-2016-6IX-D	M20 x 1.5	M16 x 1.5	.61" (15.5)	.47" (12)	.87" (22)
RM-2516-6X-D	RM-2516-6IX-D	M25 x 1.5	M16 x 1.5	.61" (15.5)	.47" (12)	1.18" (30)
RM-2520-6X-D	RM-2520-6IX-D	M25 x 1.5	M20 x 1.5	.61" (15.5)	.47" (12)	1.18" (30)
RM-3216-6X-D	RM-3216-6IX-D	M32 x 1.5	M16 x 1.5	.65" (16.5)	.47" (12)	1.61" (41)
RM-3220-6X-D	RM-3220-6IX-D	M32 x 1.5	M20 x 1.5	.65" (16.5)	.47" (12)	1.61" (41)
RM-3225-6X-D	RM-3225-6IX-D	M32 x 1.5	M25 x 1.5	.65" (16.5)	.47" (12)	1.61" (41)
RM-4020-6X-D	RM-4020-6IX-D	M40 x 1.5	M20 x 1.5	.67" (17)	.47" (12)	1.81" (46)
RM-4025-6X-D	RM-4025-6IX-D	M40 x 1.5	M25 x 1.5	.67" (17)	.47" (12)	1.81" (46)
RM-4032-6X-D	RM-4032-6IX-D	M40 x 1.5	M32 x 1.5	.67" (17)	.47" (12)	1.81" (46)





Ex-e Accessories - Red Fiber Washer & Grounding(Earth) Tag - NPT & Metric Sizes

Red Fiber Seal Rings - NPT	
Part Numbers	Fits Thread Size
-4°F to 203°F (-20°C to 95°C)	Page 55 for Thread Specs
 (Standard)	
SR-09-FN	3/8" NPT
SR-13-FN	1/2" NPT
SR-21-FN	3/4" NPT
SR-29-FN	1" NPT
SR-54-FN	1 1/4" NPT
SR-36-FN	1 1/2" NPT
SR-20-FN	2" NPT
SR-52-FN	2 1/2" NPT
SR-30-FN	3" NPT

Red Fiber Seal Rings - Metric	
Part Numbers	Fits Thread Size
-4°F to 203°F (-20°C to 95°C)	Page 55 for Thread Specs
 (Standard)	
SM-16-FN	M16 x 1,5
SM-20-FN	M20 x 1,5
SM-25-FN	M25 x 1,5
SM-32-FN	M32 x 1,5
SM-40-FN	M40 x 1,5
SM-50-FN	M50 x 1,5
SM-63-FN	M63 x 1,5
SM-75-FN	M75 x 1,5

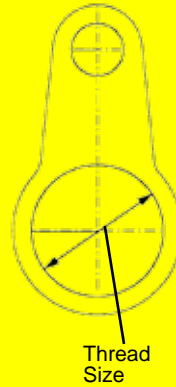

Thread Size

Grounding (Earth) Tags are installed between the cable gland and equipment to provide an grounding bond connection. They are made of Brass.



Grounding (Earth) Tags	
Part Numbers	Thread Type & Size
-4°F to 203°F (-20°C to 95°C)	Page 55 for Thread Specs
 (Brass)	
TN-09-BB	3/8" NPT
TN-13-BB	1/2" NPT
TN-21-BB	3/4" NPT
TN-54-BB	1 1/4" NPT
TN-36-BB	1 1/2" NPT
TN-20-BB	2" NPT
TN-52-BB	2 1/2" NPT
TN-30-BB	3" NPT
TM-20-BB	M20 x 1,5
TM-25-BB	M25 x 1,5
TM-32-BB	M32 x 1,5
TM-40-BB	M40 x 1,5
TM-50-BB	M50 x 1,5
TM-63-BB	M63 x 1,5
TM-75-BB	M75 x 1,5

Ex-e Accessories - Serrated Washers & Shrouds NPT & Metric Sizes

Serrated Washers - NPT	
Part Numbers	Fits Thread Size
-4°F to 203°F (-20°C to 95°C)	Page 55 for Thread Specs
 (Stainless Steel)	
WN-09-SS	3/8" NPT
WN-13-SS	1/2" NPT
WN-21-SS	3/4" NPT
WN-29-SS	1" NPT
WN-54-SS	1 1/4" NPT
WN-36-SS	1 1/2" NPT
WN-20-SS	2" NPT
WN-52-SS	2 1/2" NPT
WN-30-SS	3" NPT

Serrated Washers - Metric	
Part Numbers	Fits Thread Size
-4°F to 203°F (-20°C to 95°C)	Page 55 for Thread Specs
 (Stainless Steel)	
WM-16-SS	M16 x 1,5
WM-20-SS	M20 x 1,5
WM-25-SS	M25 x 1,5
WM-32-SS	M32 x 1,5
WM-40-SS	M40 x 1,5
WM-50-SS	M50 x 1,5
WM-63-SS	M63 x 1,5
WM-75-SS	M75 x 1,5

Shroud - NPT & Metric		
Part Numbers	Fits EXIOS Size	Fits Thread Size
-4°F to 203°F (-20°C to 95°C)	Page 55 for Thread Specs	Page 55 for Thread Specs
 (PVC)		
SE-2K-PV	20-1	3/8" NPT / M20
SE-2M-PV	20-2	1/2" NPT / M20
SE-2L-PV	20-3	1/2" NPT / M25
SE-25-PV	25	3/4" NPT / M25
SE-32-PV	32	1" NPT / M32
SE-40-PV	40	1-1/4" NPT / M40
SE-50-PV	50	2" NPT / M50
SE-63-PV	63	2-1/2" NPT / M63
SE-75-PV	75	3" NPT / M75

Serrated Washer To dampen vibrations of the cable gland/assembly which may loosen the cable gland or locknut.the cable is eliminated. Made of Stainless Steel (INOX).

Provides additional protection to weather and corrosion protection of a cable gland in Hazardous area locations.

Available in NPT & Metric Threads.

