

GPS/GSM/WiFi Combinational Antenna

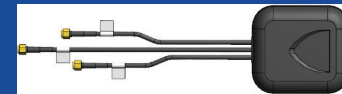

AEACBA059015-C3GSW

52 x 59 x 15 mm
RoHS/RoHS II Compliant
MSL - 1

FEATURES

- Active GPS with integrated LNA
- 2G/3G band support
- 2.4 GHz WiFi
- Circular polarization
- Adhesive mounting

APPLICATIONS

- Telematics
- Smart meter
- Transportation
- Remote monitoring
- IoT
- M2M

Electrical Characteristics

Parameters	Min.	Typ.	Max	Units	Note
GPS Antenna					
Center Frequency		1575.42±1		MHz	
Band Width		CF±5		MHz	
VSWR			1.5		
Polarization Model		RHCP			
Impedance		50		Ω	
Gain		2.0		dBic	Zenith
Axial Ratio			3	dB	
LNA Gain		28±2		dB	
LNA Noise Figure			1.5		
LNA Ex-band Attenuation		12 16		dB	@ CF+50MHz @ CF-50MHz
LNA VSWR			2.0		
LNA Supply Voltage		2.2~5		V	DC
LAN Current Consumption		5~15		mA	
GSM Antenna					
Frequency Range		824~960MHz/1710~2170		MHz	
VSWR			2.0		
Polarization		Linear			
Gain		2.0		dB	
Impedance		50		Ω	



5101 Hidden Creek Ln Spicewood TX 78669
Phone: 512-371-6159 | Fax: 512-351-8858
For terms and conditions of sales, please visit:
www.abracon.com

REVISED: 08.16.2018

ABRACON IS
ISO9001-2015
CERTIFIED

GPS/GSM/WiFi Combinational Antenna



AEACBA059015-C3GSW

52 x 59 x 15 mm
RoHS/RoHS II Compliant
MSL - 1

Electrical Characteristics

Parameters	Min.	Typ.	Max	Units	Note
WiFi Antenna					
Frequency Range		2400~2483.5		MHz	
Band Width		83.5		MHz	
VSWR			2.0		
Polarization		Linear			
Gain		3		dBi	
Impedance		50		Ω	

Mechanical Characteristics

Parameters	Note
Connector	SMA Male
Cable Type	RG174
Mounting	Adhesive
Dimensions	52 x 59 x 15 mm
Material	ABS

Dimensions

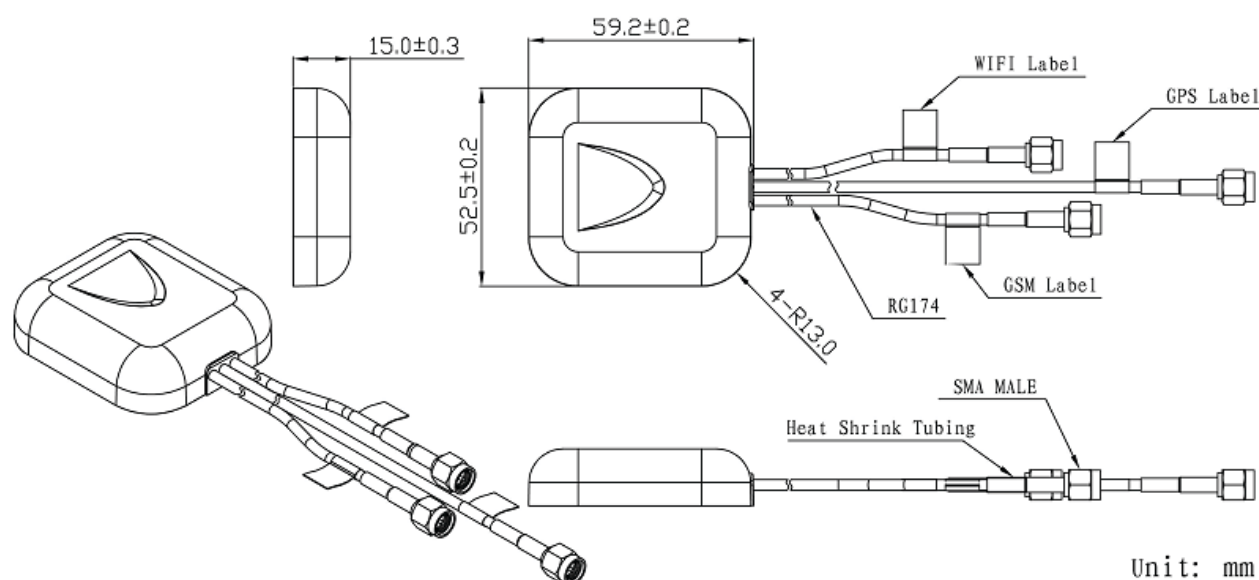

GPS/GSM/WiFi Combinational Antenna



AEACBA059015-C3GSW

52 x 59 x 15 mm
RoHS/RoHS II Compliant
MSL - 1

Product Image



Radiation Patterns

GPS Antenna

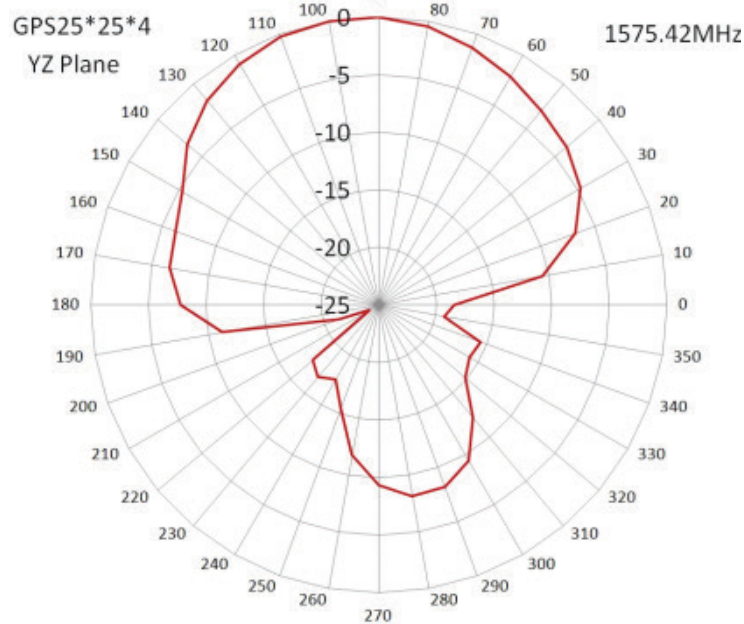
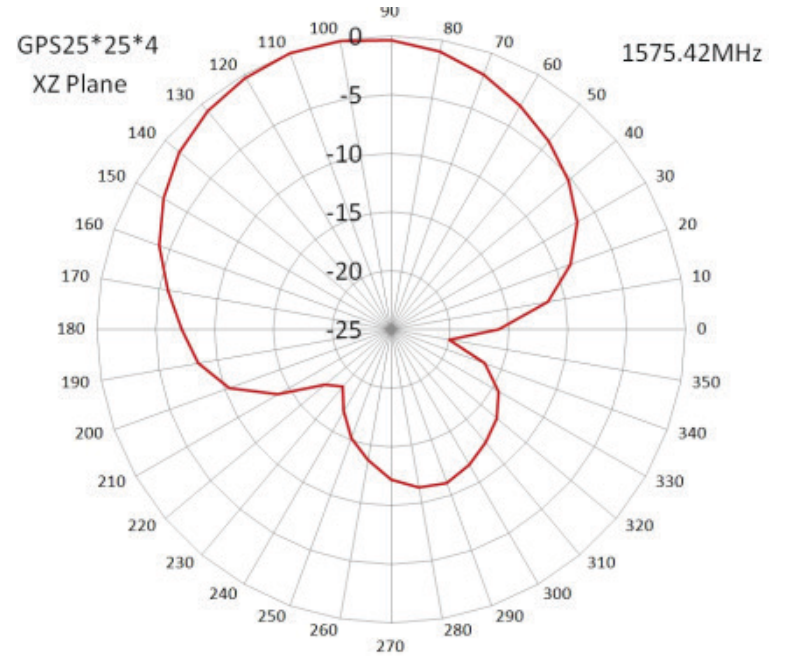
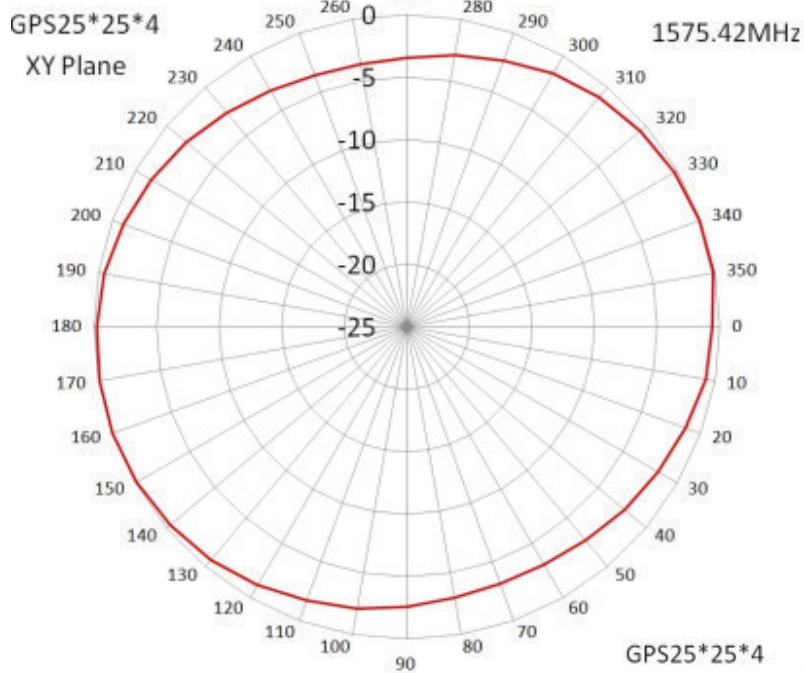

5101 Hidden Creek Ln Spicewood TX 78669
Phone: 512-371-6159 | Fax: 512-351-8858
For terms and conditions of sales, please visit:
www.abracon.com

REVISED: 08.16.2018

ABRACON IS
ISO9001-2015
CERTIFIED



AEACBA059015-C3GSW

52 x 59 x 15 mm
RoHS/RoHS II Compliant
MSL - 1

Radiation Patterns

GSM Antenna

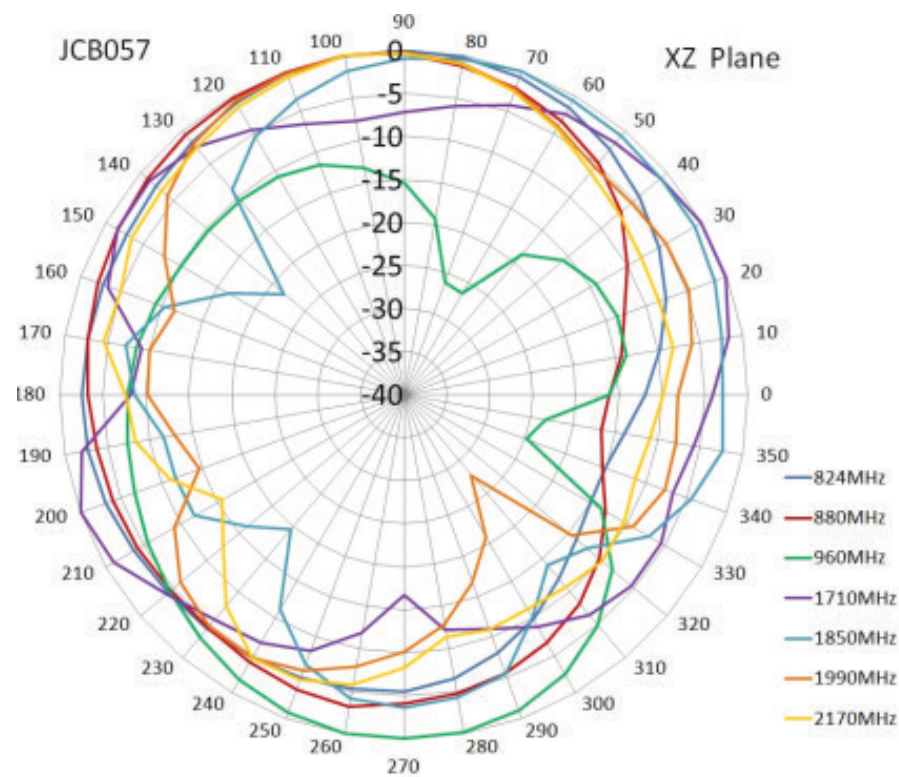
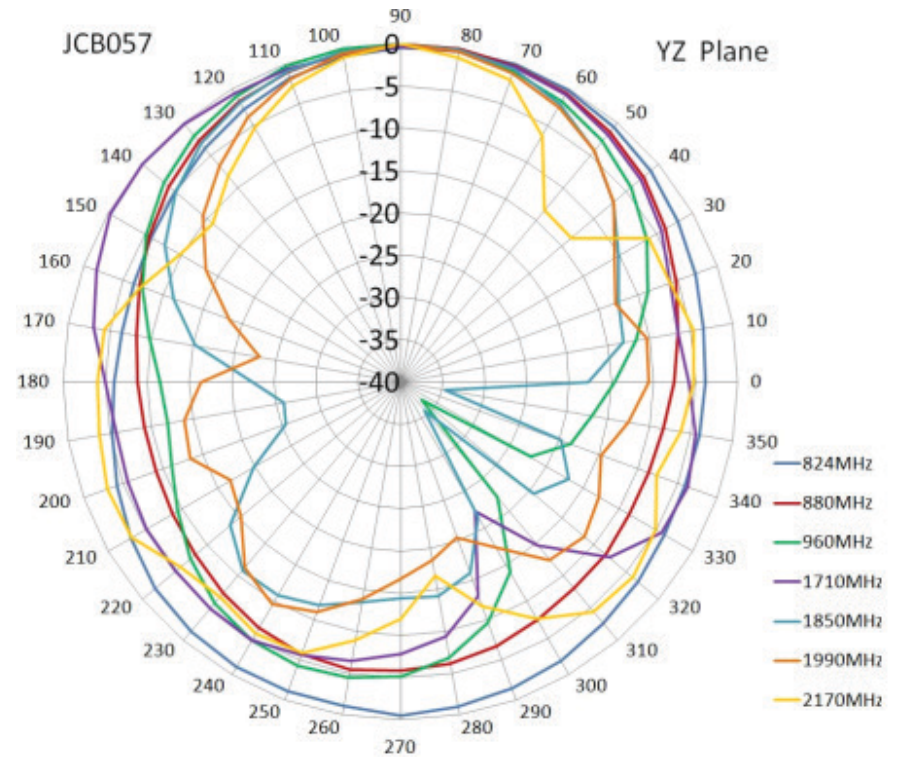
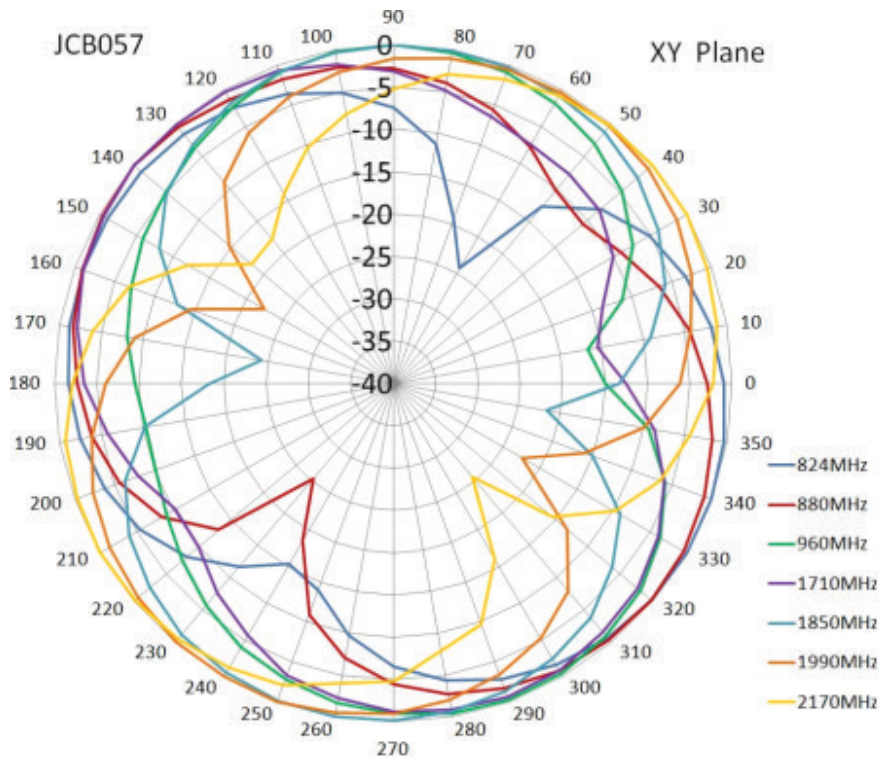



AEACBA059015-C3GSW

52 x 59 x 15 mm
RoHS/RoHS II Compliant
MSL - 1

Radiation Patterns

WiFi Antenna

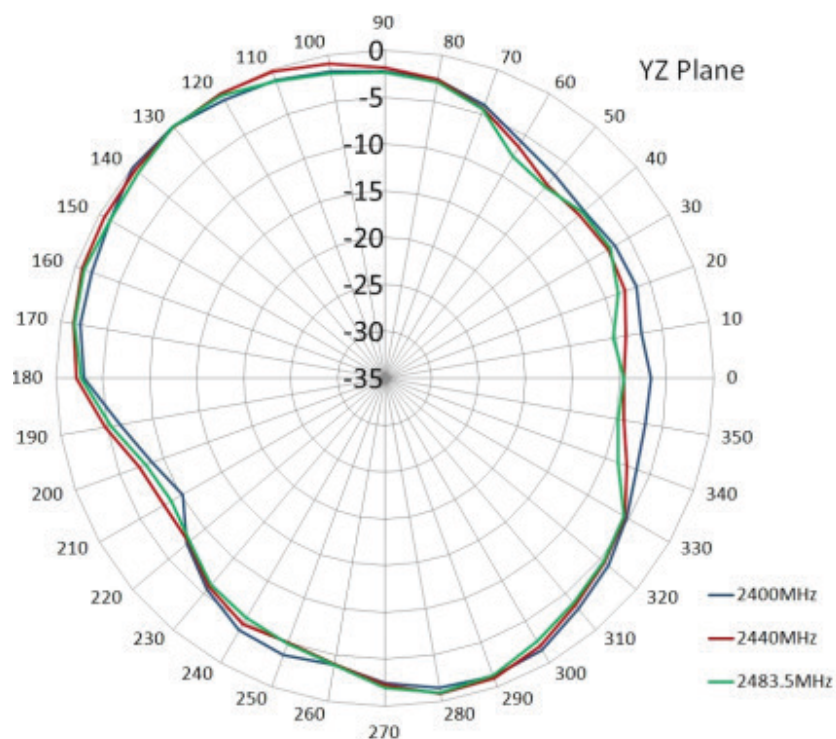
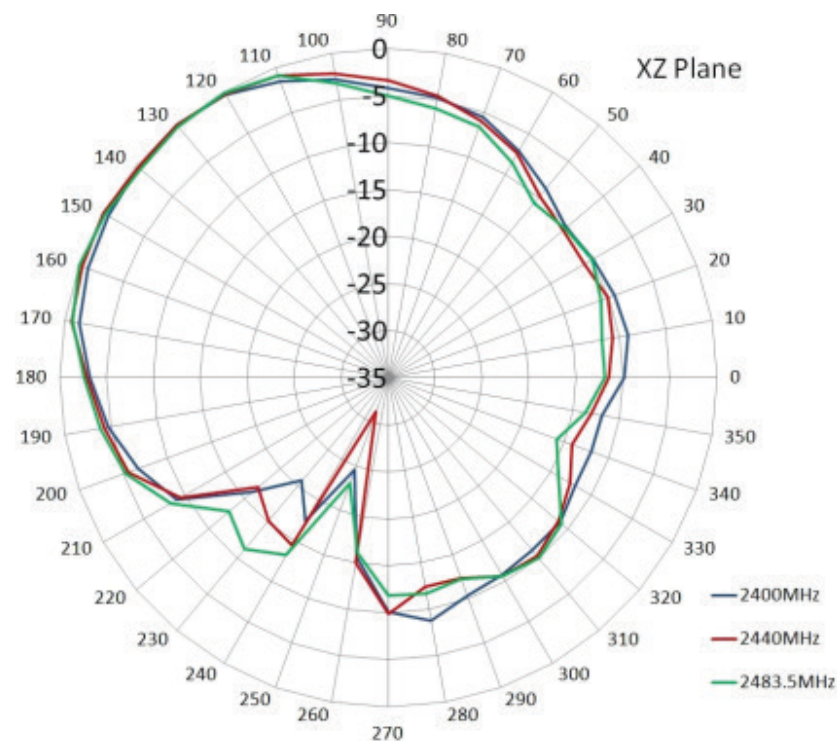
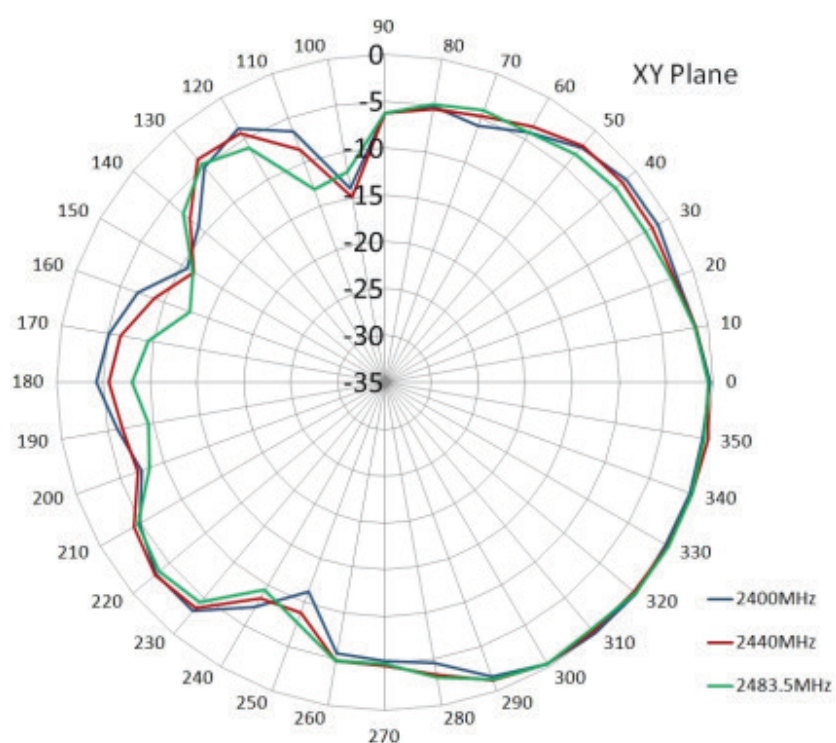

GPS/GSM/WiFi Combinational Antenna



AEACBA059015-C3GSW

52 x 59 x 15 mm
RoHS/RoHS II Compliant
MSL - 1

Packaging

Each 70 x 32 x 15cm size carton includes 50 pcs antenna, weighs 12 kg



5101 Hidden Creek Ln Spicewood TX 78669
Phone: 512-371-6159 | Fax: 512-351-8858
For terms and conditions of sales, please visit:
www.abracon.com

REVISED: 08.16.2018

ABRACON IS
ISO9001-2015
CERTIFIED