

### Small & Slim Twin/1 Form C type Automotive Relay

# CT RELAYS

<Protective construction>  
Sealed

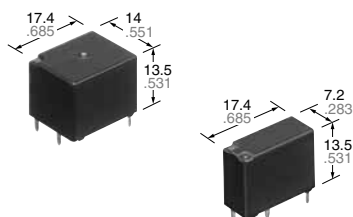

(Unit: mm inch)

**RoHS compliant**

## FEATURES

- Terminal layout for simplifying PC board pattern design
- Capable of 25A high-capacity load switching with compact size

## TYPICAL APPLICATIONS

- Powered windows, Automatic door locks, Powered mirrors, Powered sunroof, Powered seats, Lift gates, Slide door closers, etc.

## ORDERING INFORMATION

Contact arrangement  
1: 1 Form C  
2: 1 Form C×2 (8 pins)  
5: 1 Form C×2 (10 pins)

Rated coil voltage, DC  
12: 12 V

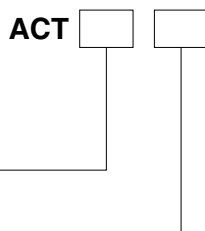

## TYPES

Contact arrangement	Rated coil voltage	Part No.	Packing	
			Carton (tube)	Case
1 Form C	12 V DC	ACT112	30 pcs.	1,500 pcs.
1 Form C × 2 (8 pins)		ACT212	30 pcs.	900 pcs.
1 Form C × 2 (10 pins)		ACT512		

## RATING

### 1. Coil data

Rated coil voltage	Operate (Set) voltage (at 20°C 68°F) (Initial)	Release (Reset) voltage (at 20°C 68°F) (Initial)	Rated operating current [±10%] (at 20°C 68°F)	Coil resistance [±10%] (at 20°C 68°F)	Rated operating power (at 20°C 68°F)	Usable voltage range
12V DC	Max. 7.2 V DC	Min. 1.0 V DC	66.7 mA	180Ω	800 mW	10 to 16V DC

Note: Other operate (set) voltage types are also available. Please inquire our sales representative for details.

# CT (ACT)

## 2. Specifications

Item		Specifications
Contact data	Contact arrangement	1 Form C × 2, 1 Form C
	Contact resistance (initial)	Max. 100mΩ (N.O.: Typ. 7mΩ, N.C.: Typ. 10mΩ) (By voltage drop 1A 6V DC)
	Contact material	Ag alloy
	Rated switching capacity (resistive)	N.O. side: 20 A 14V DC, N.C. side: 10 A 14V DC
	Max. carrying current*1	N.O. side: 25 A for 1 hour, 35 A for 2 minutes (Coil applied voltage 14V DC, at 20°C 68°F) 20 A for 1 hour, 30 A for 2 minutes (Coil applied voltage 14V DC, at 85°C 185°F)
	Min. switching load (resistive)*2	1 A 14V DC (at 20°C 68°F)
Insulated resistance (initial)		Min. 100 MΩ (at 500V DC, Measurement at same location as "Dielectric strength" section.)
Dielectric strength (initial)	Between open contacts	500 Vrms for 1 min. (Detection current: 10mA)
	Between contacts and coil	500 Vrms for 1 min. (Detection current: 10mA)
Time characteristics (initial)	Operate (Set) time (at Rated voltage)	Max. 10ms (at 20°C 68°F, without bounce time)
	Release (Reset) time (at Rated voltage)	Max. 10ms (at 20°C 68°F, without bounce time) (without diode)
Shock resistance	Functional	Min. 100 m/s <sup>2</sup> {approx. 10G} (Half-wave pulse of sine wave: 11ms; detection time: 10μs)
	Destructive	Min. 1,000 m/s <sup>2</sup> {approx. 100G} (Half-wave pulse of sine wave: 6ms)
Vibration resistance	Functional	10 to 100 Hz, Min. 44.1 m/s <sup>2</sup> {approx. 4.5G} (Detection time: 10μs)
	Destructive	10 to 500 Hz, Min. 44.1 m/s <sup>2</sup> {approx. 4.5G}, Time of vibration for each direction; X, Y direction: 2 hours, Z direction: 4 hours
Expected life	Mechanical	Min. 10 <sup>7</sup> (at 120 cpm)
	Electrical	<Resistive load> Min. 10 <sup>5</sup> (at rated switching capacity, operating frequency: 1s ON, 9s OFF) <Motor load> N.O. side: Min. 2 × 10 <sup>5</sup> at Inrush 25A, Steady 5A 14 V DC, Min. 10 <sup>5</sup> at 25A 14 V DC motor lock condition N.C. side: Min. 2 × 10 <sup>5</sup> at brake current 20A 14 V DC (operating frequency: 0.5s ON, 9.5s OFF)
Conditions	Conditions for usage, transport and storage*3	Ambient temperature: -40 to +85°C -40 to +185°F, Humidity: 5 to 85% R.H. (Please avoid icing or condensation)
Weight		Twin type: approx. 8 g .28 oz, 1 Form C type: approx. 4 g .14 oz

Notes: \*1. Depends on connection conditions. Also, this does not guarantee repeated switching. We recommend that you confirm operation under actual conditions.

\*2. This value can change due to the switching frequency, environmental conditions, and desired reliability level, therefore it is recommended to check this with the actual load.

\*3. The upper operation ambient temperature limit is the maximum temperature that can satisfy the coil temperature rise value. For details, please refer to the "Automotive Relay Users Guide".

Please inquire our sales representative if you will be using the relay in a high temperature atmosphere (110°C 230°F).

\* If the relay is used continuously for long periods of time with coils on both sides in an energized condition, breakdown might occur due to abnormal heating depending on the carrying condition. Therefore, please inquire our sales representative when using with a circuit that causes an energized condition on both sides simultaneously.

## REFERENCE DATA

1-(1). Coil temperature rise (at room temperature)

Sample: ACT212, 3pcs.

Carrying current: 0A, 10A, 20A

Ambient temperature: Room temperature

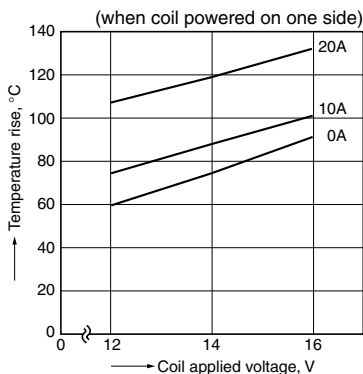

1-(2). Coil temperature rise (at 85°C 185°F)

Sample: ACT212, 3pcs.

Carrying current: 0A, 10A, 20A

Ambient temperature: 85°C 185°F

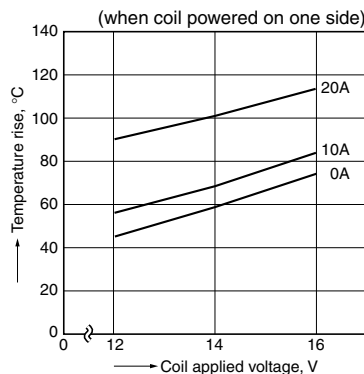

2. Max. switching capability (Resistive load, initial)

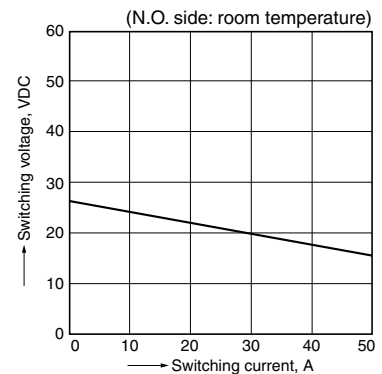

3. Ambient temperature and usable voltage range

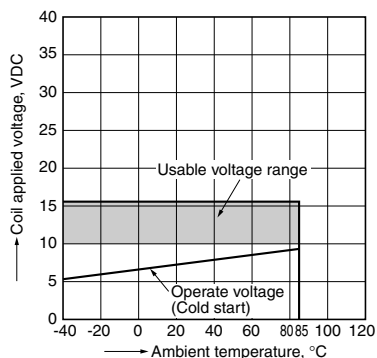

4. Distribution of operate (set) and release (reset) voltage

Sample: ACT212, 40pcs.

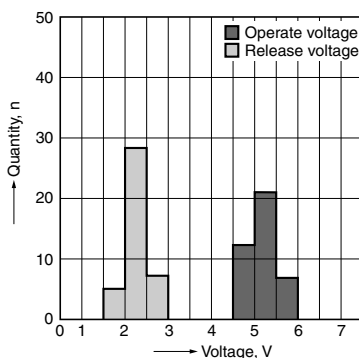

5. Distribution of operate (set) and release (reset) time

Sample: ACT212, 40pcs.

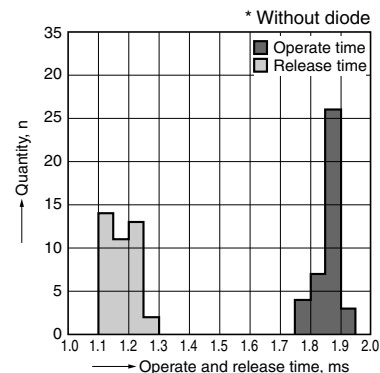

6-(1). Electrical life test (Motor free)

Sample: ACT212, 3pcs.  
 Load: Inrush 25A, steady 5A  
 Brake current: 13A 14V DC,  
 Power window motor actual load (free condition)  
 Operating frequency: ON 0.5s, OFF 9.5s  
 Ambient temperature: Room temperature  
 Circuit:

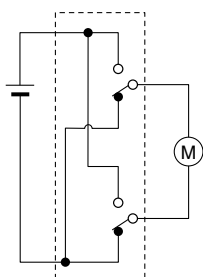

Change of operate (set) and release (reset) voltage

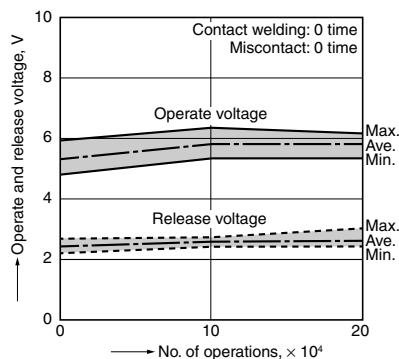

Change of contact resistance

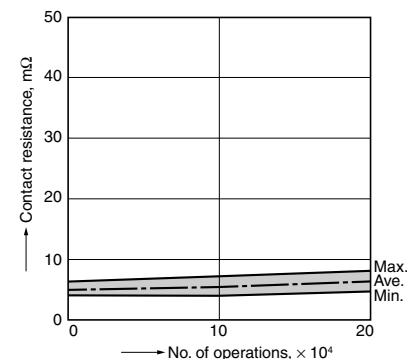

Load current waveform

Load: Inrush current: 25A, Steady current: 6A  
 Brake current: 13A

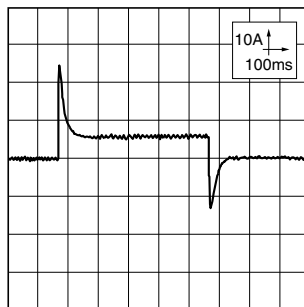

# CT (ACT)

## 6-(2). Electrical life test (Motor lock)

Sample: ACT212, 3pcs.  
 Load: 25A 14V DC  
 Power window motor actual load (lock condition)  
 Switching frequency: ON 0.5s, OFF 9.5s  
 Ambient temperature: Room temperature  
 Circuit:

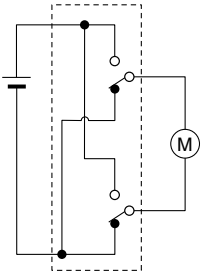

### Change of operate (set) and release (reset) voltage

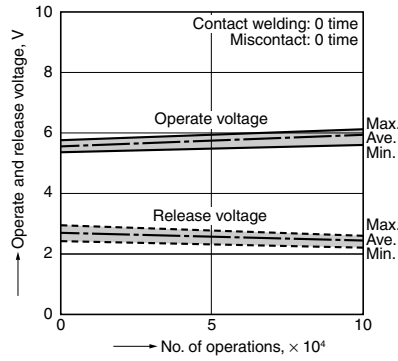

### Change of contact resistance

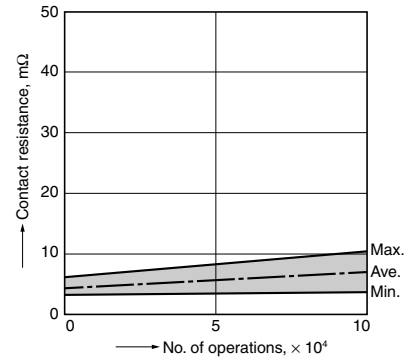

### Load current waveform

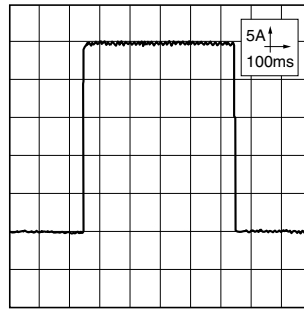

## 6-(3). Electrical life test (Motor lock)

Sample: ACT212, 3pcs.  
 Load: 20A 14V DC,  
 door lock motor actual load (Lock condition)  
 Switching frequency: ON 0.3s, OFF 19.7s  
 Ambient temperature: Room temperature  
 Circuit:

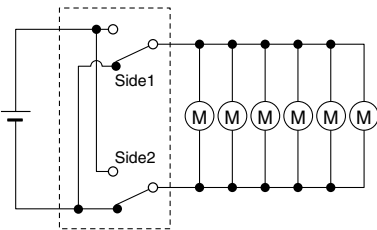

### Change of operate (set) and release (reset) voltage

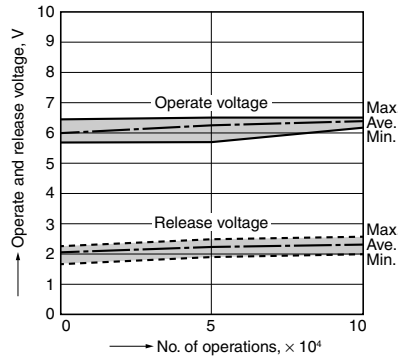

### Change of contact resistance

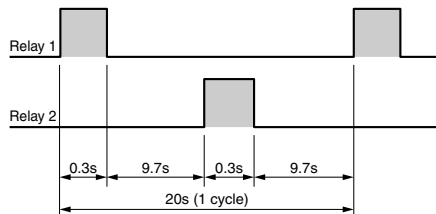
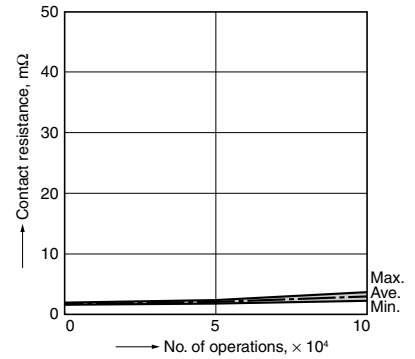

### Load current waveform

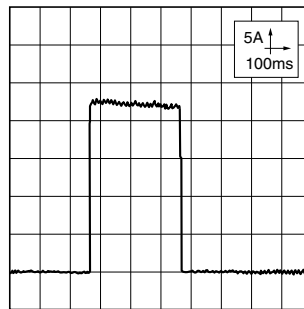

# DIMENSIONS (mm inch)

The CAD data of the products with a **CAD** mark can be downloaded from: <http://industrial.panasonic.com/ac/e/>

## 1. Twin type (8 pins)

**CAD**



External dimensions

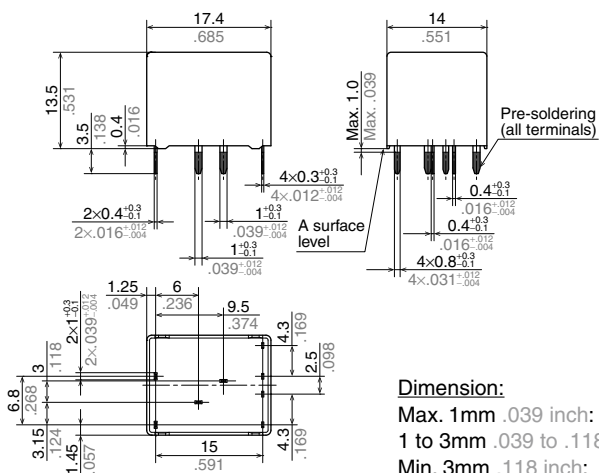

Dimension:	Tolerance
Max. 1mm .039 inch:	$\pm 0.1 \pm .004$
1 to 3mm .039 to .118 inch:	$\pm 0.2 \pm .008$
Min. 3mm .118 inch:	$\pm 0.3 \pm .012$

PC board pattern (Bottom view)

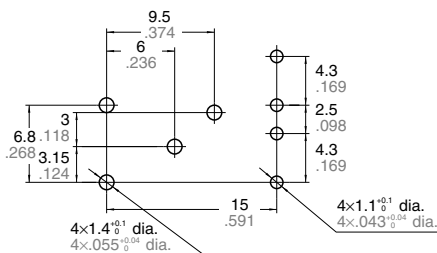

Tolerance:  $\pm 0.1 \pm .004$

Schematic (Bottom view)

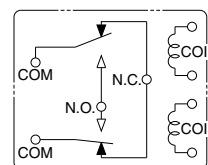

\* Dimensions (thickness and width) of terminal is measured after pre-soldering. Intervals between terminals is measured at A surface level.

## 2. Twin type (10 pins)

**CAD**



External dimensions

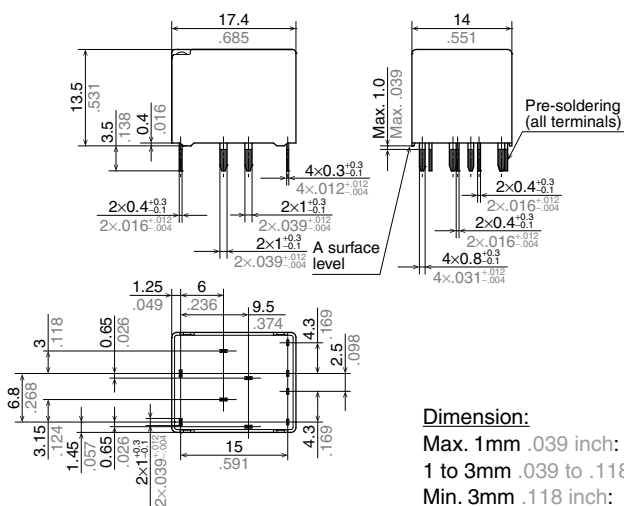

Dimension:	Tolerance
Max. 1mm .039 inch:	$\pm 0.1 \pm .004$
1 to 3mm .039 to .118 inch:	$\pm 0.2 \pm .008$
Min. 3mm .118 inch:	$\pm 0.3 \pm .012$

PC board pattern (Bottom view)

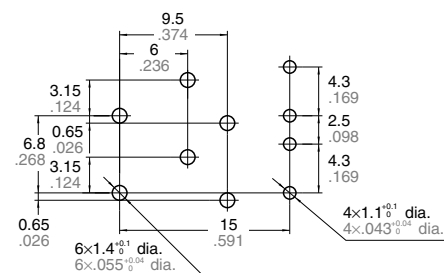

Tolerance:  $\pm 0.1 \pm .004$

Schematic (Bottom view)

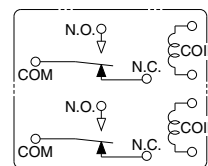

\* Dimensions (thickness and width) of terminal is measured after pre-soldering. Intervals between terminals is measured at A surface level.

# CT (ACT)

## 3. Slim 1c type (8 pins)

CAD



### External dimensions

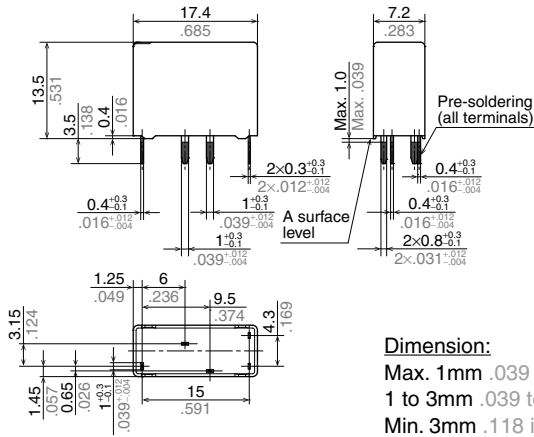

### PC board pattern (Bottom view)

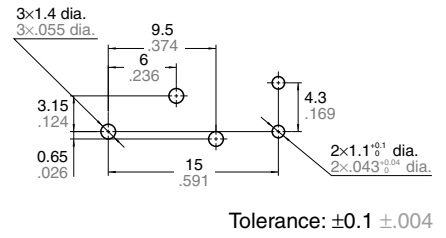

### Schematic (Bottom view)

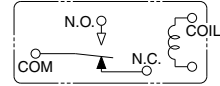

Dimension:	Tolerance
Max. 1mm .039 inch:	±0.1 ±.004
1 to 3mm .039 to .118 inch:	±0.2 ±.008
Min. 3mm .118 inch:	±0.3 ±.012

\* Dimensions (thickness and width) of terminal is measured after pre-soldering.  
Intervals between terminals is measured at A surface level.

## EXAMPLE OF CIRCUIT

Forward/reverse control circuits of DC motor for power windows

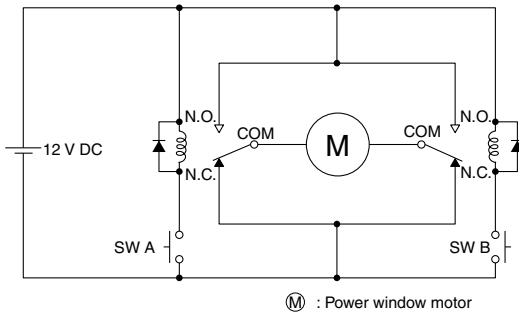

For general cautions for use, please refer to the “Automotive Relay Users Guide”.

---

Please contact .....

**Panasonic Corporation**

Electromechanical Control Business Division

■ 1006, Oaza Kadoma, Kadoma-shi, Osaka 571-8506, Japan  
[industrial.panasonic.com/ac/e/](http://industrial.panasonic.com/ac/e/)

**Panasonic**<sup>®</sup>

©Panasonic Corporation 2017