

Industrial Automation Catalog Section - U906

Switches & Pilot Devices

Switches & Pilot Devices

TW Series

- Selection Guide
- Non-Illuminated Pushbuttons, Pilot Lights, Illuminated Pushbuttons
- Selector Switches
- Nameplates
- Accessories
- Dimensions
- Instructions

For up-to-date information, or to request a full copy of this catalog, contact us at www.idec.com or 800-262-IDEC..

Due to continuous product improvements, specifications are subject to change without notice.



TW Series Oiltight Switches and Pilot Devices Ø 7/8" (22mm)

Series Model	AΔW...	AΔLW...	ASW...	ASLW...	APW...
Appearance	Flush 	Extended 			
	Extended 	Extended/Shroud 	Knob Operator 		Dome Lens
	Mushroom 	Mushroom 	Lever Operator 	Knob Operator (w/transformer) 	Flush Lens
	Square Flush 	Square Extended 	Key Operator 	Knob Operator (full voltage) 	Square Flush
	Square Extended 	Push-Pull 			Square Flush (w/transformer)
	Pushlock Turn Reset 	Pushlock Turn Reset 			
See Page	A-124	A-132	A-136	A-141	A-129
Operator Types	Non-illuminated Pushbuttons: • Momentary • Maintained • E-Stop	Illuminated Pushbuttons: • Momentary • Maintained • E-Stop • LED/Incandescent	Selector Switches: • 2, 3, 4, 5-position • Maintained • Spring Return • Colored knobs/ inserts	Illuminated Selectors: • Full Voltage/ Transformer • LED/Incandescent	Pilot Lights: • Full Voltage/ Transformer • LED/Incandescent
Contact Configuration	Modular: NO,NC, NO-EM, NC-LB (maximum 6 contacts)		See Contact Arrangement Charts page A-146.		—
Contact Ratings	10A thermal current				
Electrical Life	600V maximum				
Mechanical Life	Momentary Pushbuttons: 5,000,000 operations minimum; Others: 500,000 operations minimum Selector Switches: 500,000 operations minimum				
Degree of Protection	NEMA Type 1, 2, 3, 3R, 4, 4X, 5, 12, 13; Waterproof/Oiltight/Corrosion Resistant: IP65				
Termination	M3.5 Screw Terminals with captive sems plate				
Approvals	UL Listed File No. E70646	CSA Certified File No. LR48366	TÜV Rheinland	File No. 9561116E01	



1. Illuminated units include lamp.
2. Available as assembled or sub-assembled components.

General Information

Information About LED Lamps

Light-emitting diodes (LEDs) are P–N junction semiconductors with mechanisms called “junction electro-luminescence.” Application of direct current results in radiation or emission of a monochromatic light.

Different semiconductor materials produce different wavelengths of light as shown below:

Specifications	Green	Gallium Phosphide (GaP)	5600 Å
	Yellow	Gallium Arsenide Phosphide (GaAsP)	5800 Å
	Amber	Gallium Arsenide Phosphide (GaAsP)	6300 Å
	Red	Gallium Arsenide Phosphide (GaAsP)	6600 Å
	Infrared	Gallium Arsenide (GaAs)	9000 Å



Advantages of Using LEDs

- LEDs are used when heat generated by incandescent lamps would damage nearby equipment or interfere with a precision process. This is particularly advantageous when multiple lights are grouped.
- LEDs can operate at low temperatures which would cause incandescent lamps to fail, since glass cracks during rapid cooling.
- LEDs consume 50 times less power than incandescent lamps, thereby reducing energy consumption.
- LEDs last 500 times longer than incandescent lamps. LEDs average a million hours (114 years) while incandescent lamps average 2000 hours.
- LEDs do not generally “blow out” unless subjected to a severe overvoltage. They exhibit a half-life type dimishment in brightness over time. After 50,000 hours (6 years) of use, IDEC LEDs will retain approximately half of their original intensity.
- IDEC’s SUPERBRIGHT LEDs have high visibility.
- LEDs require little or no maintenance because of long life and high reliability.

IDEC Recommendations

For optimum results, especially when using switches and pilot lights in operating environments which are conducive to overheating, use IDEC LED illuminated units. Transformers are available for use with incandescent illuminated units, which operate at lower voltages to avoid overheating.

When IDEC’s L-120L lamp is used, make sure ambient temperatures do not exceed 30°C (86°F). If a lamp from another supplier is used, it should be rated for less than 1.8 watts (15mA at 120V AC), with ambient temperatures as stated above.

Information About Incandescent Lamps

Filament-type incandescent lamps operate within the following parameters.

Light output and life expectancy depend on operating voltage. Light output varies to the 3rd or 4th power of the voltage. Life expectancy varies inversely to the 12th power of voltage. In other words, over-voltage of 5% reduces life expectancy by 50%. Under-voltage of 5% doubles life expectancy at the price of light output efficiency.

Inrush current (initial current through the filament) has an adverse effect on life expectancy. Cold resistance (room temperature) will have a more detrimental effect than hot resistance to inrush current. Life expectancy of incandescent lamps can be maximized by reducing occurrences of cold resistance to inrush current.

Continued intermittent flashing will significantly reduce life expectancy. When using an incandescent lamp with a tungsten filament, flashing will not reduce life expectancy as long as light output does not exceed that of steady burning.

When an incandescent lamp must withstand shock and vibration, use low voltage/high amperage (5–6V/60–120mA) lamps. These lamps have a short, thick filament with a high resonant frequency.

Provide cooling by using a heat sink, particularly when multiple incandescent lamps are grouped or when air circulation is limited. Make sure ambient temperatures do not exceed 100°C (212°F) for maximum life of incandescent lamps.

Comparison: LED vs. Incandescent Lamps

	<i>Superbright LEDs</i>	<i>Incandescent</i>	
Characteristics	Heat Dissipation	Very Low	High
	Life Expectancy	Very Long	Short
	Reliability	Very High	Low
	Mechanical Strength	Not Susceptible	Susceptible to Shock/Vibration
	Maintenance Required	Negligible	Frequent
	Operation at Low Temps.	Possible	Not Possible
	Inrush Current	Negligible	Very Large
	Voltage Effects on Life	Insignificant	Significant
	Brightness	Slightly Less	Slightly More

Ordering Information

1. IDEC offers assembled and sub-assembled switches and pilot lights for your convenience. In some cases there is a cost difference, with sub-assembled units costing slightly less. Since assembled units are custom made to your order, a couple of days for assembly is added to delivery . To minimize delivery or inventory requirements, it is recommended that switches and pilot lights be ordered as sub-components.
2. When ordering pilot lights or illuminated pushbuttons, make sure to specify the color code in place of the asterisk in the part number, (LED or incandescent lamp included). Spare lamps can be ordered and are listed with sub-assembly components.
3. Accessories, such as locking ring wrench, lens removal tool, and lamp holder, are available to make installation and assembly easier. IDEC recommends using these accessories and is not responsible for damage as a result of using the wrong tool.
4. Marking plates are available for switches and pilot lights which feature a flat lens. Printed mylar (not included) can also be inserted under lens for labeling purposes.
5. Nameplates are available for TW, 7/8" (22mm), HW 7/8" (22mm), and TWTD series, Ø1-13/64" (30mm). For prompt delivery, order standard legends. Custom engraving is also offered for an additional charge.

Installation and Operation

1. Use the appropriate lamp holder to remove or install LED or incandescent lamps. Using pliers will damage the lamp.
2. When mounting switches and pilot lights into a panel, use locking ring wrench. Using pliers or tightening excessively will damage the locking ring.
3. A series, 21/64" (8mm), can be mounted on a panel 0.019" (0.5mm) to 0.236" (6mm) thick.
4. LW 7/8" (22mm), TW, 7/8" (22mm), and TWTD series, Ø1-13/64" (30mm), feature an adjustment ring for mounting on a panel 0.038" (1mm) to 0.236" (6mm) thick. Using a nameplate or an anti-rotation ring adds 0.031" (0.8mm) to the panel thickness.
5. When applicable, solder terminals within 20W/5sec or 260°/3sec without exerting external force to the terminals. Use a non-corrosive resin liquid flux.
6. The operating voltage for LED units represents a complete DC value. When using a pulsing voltage, such a full-wave rectification, keep peak currents within the forward current I_f . Peak currents exceeding I_f may shorten the life of the LED lamp.
7. To avoid a short circuit, never connect NO and NC contacts to different voltages or power sources.
8. Optimum performance of TW and TWTD illuminated pushbuttons, selector switches, and pilot lights is obtained with IDEC LED and incandescent lamps.
9. For maximum life of incandescent lamps (approximately 2000 hours), use within the rated operating voltage. If it is necessary to use a higher voltage, keeping ambient temperature below 30°C (86°F) will help prolong the life of an incandescent lamp.



If excessive voltage is applied (over 50V), the lamp may blow and the lens holder may pop out.

TW Series — 22mm NEMA Style Pushbuttons



A

TW NEMA Style Switches with snap-on contacts

Key features include:

- Corrosion resistant octagonal chrome plated locking bezel
- Snap-on 10A contact blocks
- Transformer or full voltage
- Incandescent or LED illumination
- Slow make, double break, self cleaning contacts
- Modular construction for maximum flexibility
- NEMA 4X and IP65 watertight/oiltight panel
- Available assembled or as sub-components
- Large M3.5 screw terminals with captive sems plate

IDEC has your 22mm switching needs covered.

Button styles include flush, extended, mushroom, or square and all bodies are crafted from fracture-resistant nylon.

All illuminated units feature two lense styles, one that maximizes light dispersion, the other accomodates direct lense engraving.

Self cleaning contact mechanisms allow for a wide current rating, 5mA to 10A, which reduces the need for various contact materials.

When looking for a 22mm switch that is durable, easy to use, and versatile, then IDEC's TW series is your solution.



UL Listed
File No. E70646



File No. 9561116E01
Applicable when using HW
series contact blocks.



CSA Certified
File No. LR48366



File No. DK95-01696



Specifications	Conforming to Standards	EN60947-1, EN60947-5-1, VDE0660-200, UL508, CSA C22-2 No.14							
	Approvals	<div style="display: flex; justify-content: space-between;"> <div style="text-align: center;"> File No. E70646 </div> <div style="text-align: center;"> File No. LR48366 </div> </div> <div style="display: flex; justify-content: space-between; margin-top: 10px;"> <div style="text-align: center;"> TÜV Rheinland Registration No: J9551802 (E-Stops) Registration No: J9551803 (All other switches) Registration No: J9551804 (Pilot Lights) </div> <div style="text-align: center;"> </div> </div> <p>CSA: pushbuttons and selector switches: A600 pilot lights and illuminated pushbuttons, direct supply pilot lights and illuminated pushbuttons with integral transformer (100/110, 115, 120, 200/220, 230, 240, 380, 400/440, 480V) UL: pushbuttons and selector switches: A600 pilot lights and illuminated pushbuttons, direct supply pilot lights and illuminated pushbuttons with integral transformer (100/110, 115, 120, 200/220, 230, 240, 380, 400/440, 480V) TÜV: pushbuttons and selector switches: A600=P600 (NO, NC)/Q600 (NO-EM, NC-LB) pilot lights and illuminated pushbuttons, direct supply pilot lights and illuminated pushbuttons with integral transformer (100/110, 115, 120, 200/220, 230, 240, 380, 400/440, 480V)</p>							
	Operating Temperature	Operation: -25 to +50°C (without freezing) Storage: -40 to +70°C (without freezing)							
	Vibration Resistance	10 to 55Hz, 98m/sec ² (10g) conforming to IEC6068-2-6							
	Shock Resistance	980m/sec ² (100g) conforming to IEC6068-2-7							
	Electric Shock Protection	Class 0 conforming to IEC60536							
	Degree of Protection (conforming to IEC60529) (conforming to NEMA ICS6-110)	IP65 (from front of the panel) IP20 (Type HW-F contact block) NEMA 1, 2, 3, 3R, 3S, 4, 4X, 5, 12, 13							
	Mechanical Life	Momentary pushbuttons: 5,000,000 (900 operations per hour) All other switches: 500,000							
	Pollution Degree (conforming to IEC60947-1)	3 for switches not using a transformer 2 for switches using a transformer							
	Rated Operational Characteristics	~AC-15: A600 or U _e = 250V, I _e = 3A (NO, NC, NO-EM, NC-LB) DC-13: P600 or U _e = 125V, I _e = 1.1A (NO, NC) DC-13: Q600 or U _e = 125V, I _e = 0.9A (NO-EM, NC-LB)							
	Rated Insulation Voltage	600V							
	Rated Switching Over-Voltage	Less than 4kV, conforming to IEC60947-1							
	Rated Impulse Withstanding Voltage	4kV for contact circuit 2.5kV for lamp circuit							
	Rated Thermal Current	10 Amp							
	Minimum Switching Capacity	5 mA at 3V AC/DC							
	Contact Operation	Slow break NC or slow make NO, self-cleaning							
	Recommended Terminal Torque	0.8 N m (7.1 in lb.)							
	External Short-Circuit Protection	10A 250V fuse conforming to IEC60269-1							
	Applicable Wire Size	Minimum 1 x 22 AWG, max. 2 x 14 AWG or 1 x 12 AWG							
	Contact Resistance	Initial contact resistance of 50mΩ or less							
	Contact Gap	4mm (NO and NC) 2mm (NO-EM and NC-LB)							
	Electrical Reliability	MTBF < 1 fault for 10 million operation cycles (3V DC, 5mA)							
Lamp Ratings	Incandescent: 1 W LEDs: 6, 12, 24V: 20mA / 120, 240V: 10mA								
Horsepower Rating	1/4 HP @ 120V (single-phase, non-reversing motor); 1 HP @ 240V (3 phase, non-reversing motor)								
Maximum Inrush Current	40 A (40 ms)								
Contact Material	Silver								
Contact Ratings	Break Values				Make Values				
	AC		DC		AC		DC		
	Inductive	Resistive	Inductive	Resistive	Inductive	Resistive	Inductive	Resistive	
	Rated Operating Current	120V: 6A 240V: 3A 480V: 1.5A 600V: 1.2 A	120V: 10A 240V: 6A 480V: 2A	120V: 1.1A 240V: 0.6A 12V: 4A 24V: 4A	120V: 2A 240V: 1.1A 480V: 0.4A 12V: 4A 24V: 4A	120V: 60A 240V: 30A 480V: 15A 600V: 12 A	120V: 100A 240V: 60A 480V: 20A	120V: 11A 240V: 6A 12V: 40A 24V: 40A	120V: 20A 240V: 11A 480V: 4A 12V: 40A, 24V: 40A

Non-Illuminated Pushbuttons (Assembled)

A



Assembled Pushbuttons

A B () W 1 10 () - B

Degrees of Protection

A: IP65/NEMA4X

Function

- B: Momentary
- O: Alternate
- V: Pushlock Turn Reset
- Y: Push-Pull
- K: Key On/Off Lock
- X: Pushlock Key Reset

Bezel Shape

- Blank: Octagonal
- F: Full Shroud
- G: Mushroom Shroud
- Q: Square

Button Color

- B: Black G: Green W: White
- R: Red S: Blue Y: Yellow

Contact Style

- Blank: Standard
- N: Fingersafe

Contact Arrangement

- 10: 1NO 01: 1NC
- 20: 2NO 02: 2NC
- 11: 1NO-1NC 22: 2NO-2NC

Button Shape

- 1: Flush
- 2: Extended
- 3: Mushroom
Ø 1-13/64" (Ø 29mm)
- 4: Mushroom
Ø 1-37/64" (Ø 40mm)

Series Type



W: TW Ø 7/8" (Ø 22mm)



To be used for interpreting part numbers only, not for part number development.

Non-Illuminated Pushbuttons (Assembled) con't

Part Numbers: Non-illuminated Pushbuttons





Style	Contacts	Part Numbers	
		Momentary Action	Maintained Action
Flush* 	1NO 1NC 1NO-1NC 2NO 2NC	ABW110-B,G,R ABW101-B,G,R ABW111-B,G,R ABW120-B,G,R ABW102-B,G,R	AOW110-B,G,R AOW101-B,G,R AOW111-B,G,R AOW120-B,G,R AOW102-B,G,R
Extended 	1NO 1NC 1NO-1NC 2NO 2NC	ABW210-① ABW201-① ABW211-① ABW220-① ABW202-①	AOW210-① AOW201-① AOW211-① AOW220-① AOW202-①
Recessed 	1NO 1NC 1NO-1NC 2NO 2NC	ABFW110-① ABFW101-① ABFW111-① ABFW120-① ABFW102-①	AOFW110-① AOFW101-① AOFW111-① AOFW120-① AOFW102-①
Extended with Full Shroud 	1NO 1NC 1NO-1NC 2NO 2NC	ABFW210-① ABFW201-① ABFW211-① ABFW220-① ABFW202-①	AOFW210-① AOFW201-① AOFW211-① AOFW220-① AOFW202-①
Ø 1-37/64" (40mm) Mushroom 	1NO 1NC 1NO-1NC 2NO 2NC	ABW410-① ABW401-① ABW411-① ABW420-① ABW402-①	AOW410-① AOW401-① AOW411-① AOW420-① AOW402-①
Ø 1-37/64" (40mm) Mushroom with Full Shroud 	1NO 1NC 1NO-1NC 2NO 2NC	ABGW410-① ABGW401-① ABGW411-① ABGW420-① ABGW402-①	AOGW410-① AOGW401-① AOGW411-① AOGW420-① AOGW402-①
Square Flush 	1NO 1NC 1NO-1NC 2NO 2NC	ABQW110-① ABQW101-① ABQW111-① ABQW120-① ABQW102-①	AOQW110-① AOQW101-① AOQW111-① AOQW120-① AOQW102-①
Square Extended 	1NO 1NC 1NO-1NC 2NO 2NC	ABQW210-① ABQW201-① ABQW211-① ABQW220-① ABQW202-①	AOQW210-① AOQW201-① AOQW211-① AOQW220-① AOQW202-①



1. In place of ①, specify the button color code from table on next page.
2. * Flush units include one each of Red, Green, and Black buttons.
3. For sub-assembled part numbers, see page A-127.
4. Small mushroom pushbutton Ø 1-5/32" (29mm) is available by ordering a button separately (part no. ABW3B-①).
5. For accessories, see page A-154.
6. For dimensions, see page A-156.

Non-Illuminated Pushbuttons (Assembled) con't

Part Numbers: Non-Illuminated Special Function Pushbuttons

Style	Contacts	Part Number
 Ø 1-37/64" (40mm) Pushlock Turn Reset 	1NO 1NC 1NO-1NC 2NO 2NC	AVW410-R* AVW401-R* AVW411-R* AVW420-R* AVW402-R*
Ø 1-37/64" (40mm) Push-Pull 	1NO 1NC 1NO-1NC 2NO 2NC	AYW410-① AYW401-① AYW411-① AYW420-① AYW402-①
Keylock Push On/Off 	1NO 1NC 1NO-1NC 2NO 2NC	AKW210 AKW201 AKW211 AKW220 AKW202
Ø 1-37/64" (40mm) Pushlock Key Reset * 	1NO 1NC 1NO-1NC 2NO 2NC	AXW410- R* AXW401- R* AXW411- R* AXW420- R* AXW402- R*

1. * Available in Red only.
2. In place of ①, specify the color code from table below.
3. Keyed switches are supplied with two keys. All units are keyed alike. For custom keys, contact IDEC.
4. For sub-assembled part numbers, see page A-127.
5. For accessories, see page A-154.
6. For dimensions, see page A-156.

① Button Color Code





Color	Code
Black	B
Green	G
Red	R
Blue	S
White	W
Yellow	Y

Non-Illuminated Pushbuttons (Sub-Assembled)





Contact Blocks + Operator + Button = Complete Part



Part Numbers: Operators

Style	Part Number	
	Momentary	Maintained
Round Flush/Extended 	ABW-100	AOW-100
Round with Full Shroud 	ABFW-200	AOFW-200
Ø 1-37/64" (Ø 40mm) Ø 1-5/32" (Ø 29mm) Mushroom 	ABW-300	AOW-300
Ø 1-37/64" (Ø 40mm) Mushroom with Full Shroud 	ABGW-400	AOGW-400
Square Flush/Extended 	ABQW-100	AQQW-100

Part Numbers: Special Function Operators

Style	Part Number
Ø 1-37/64" (40mm) Pushlock Turn Reset 	AVW-300
Ø 1-37/64" (40mm) Push-Pull 	AYW-400
Ø 1-37/64" (40mm) Pushlock Key Reset* 	AXW-300
Keylock Push On/Off 	AKW-200



* Pushlock Key Reset operator uses AXW4B-R button.



1. Bezel or shroud included with each pushbutton operator.
2. Contact blocks and buttons are ordered separately.



Non-Illuminated Pushbuttons (Sub-Assembled) con't

Part Numbers: Buttons

Style	Part Number
Round Flush 	ABW1B-①
Round Extended 	ABW2B-①
Square Flush 	ABQW1B-①
Square Extended 	ABQW2B-①
Ø 1-37/64" (40mm) Mushroom 	ABW4B-①
Ø 1-5/32" (29mm) Mushroom 	ABW3B-①
Ø 1-37/64" (40mm) Pushlock Turn Reset 	AVW4B-R*
Ø 1-37/64" (40mm) Push-Pull 	AYW4B-①
Pushlock Key Reset 	AXW4B-R*

-  1. In place of ①, specify the button color code from table above.
2. * Available in Red only

Part Numbers: Contact Blocks

Description	Part Number	
	1NO	1NC
Standard Exposed Screw 	HW-C10 HW-C10R (early make)	HW-C01 HW-C01R (late break)
Fingersafe (IP20), CE marked 	HW-F10 HW-F10R (early make)	HW-F01 HW-F01R (late break)
Dummy Block 	TW-DB	

-  1. Dummy blocks (no contacts) are used with an odd number of contact blocks.
2. Use of early and late break contacts creates a make before break function

① Button Color Code

Color	Code
Black	B
Green	G
Red	R
Blue	S
White	W
Yellow	Y

Pilot Lights (Assembled)



Assembled Pilot Lights

A P () W 1 () 126 D - R - ()



<p>Degree of Protection _____</p> <p>A: IP65</p> <p>Function _____</p> <p>P: Pilot Light</p> <p>Bezel Shape _____</p> <p>Blank: Octagonal Q: Square</p> <p>Series Type _____</p> <p>W: TW Ø 7/8" (Ø 22mm)</p> <p>Lens Shape _____</p> <p>1: Flush 2: Dome</p> <p>Lens Type _____</p> <p>Blank: Non-Marking B: Marking (engravable insert included)</p> <p>Rated Operational Voltage (Primary) _____</p> <table style="width: 100%; border: none;"> <tr> <td style="border: none;">Transformer/AC Adaptor Type</td> <td style="border: none;">Full Voltage Type</td> </tr> <tr> <td style="border: none;">126:120V AC</td> <td style="border: none;">99:Full Voltage</td> </tr> <tr> <td style="border: none;">246:240V AC</td> <td></td> </tr> <tr> <td style="border: none;">486:480V AC (Transformer type only)</td> <td></td> </tr> </table>	Transformer/AC Adaptor Type	Full Voltage Type	126:120V AC	99:Full Voltage	246:240V AC		486:480V AC (Transformer type only)		<p>Lamp Voltage (Full Voltage Only)</p> <p>Incandescent</p> <p>6: 6V AC/DC 12: 12V AC/DC 24: 24V AC/DC</p> <p>LED</p> <p>6: 6V DC 12: 12V AC/DC 24: 24V AC/DC 120:120V AC</p> <p>Lens Color Code</p> <p>A: Amber G: Green R: Red S: Blue W: White C: Clear (square only) Y: Yellow (LED only)</p> <p>Lamp Type</p> <p>Blank: Incandescent Lamp D: LED Lamp</p>
Transformer/AC Adaptor Type	Full Voltage Type								
126:120V AC	99:Full Voltage								
246:240V AC									
486:480V AC (Transformer type only)									



1. Use only when interpreting part numbers. Do not use for developing part numbers.
2. All transformers step down to 6V.

Pilot Lights (Assembled) con't

Part Numbers: LED Pilot Lights

Style		Operating Voltage	Part Number
	Transformer	120VAC 240VAC 480VAC	APW2126 ^{④-②} APW2246 ^{④-②} APW2486 ^{④-②}
	Full Voltage	—	APW299 ^{④-②-③}
	Transformer	120VAC 240VAC 480VAC	APW1126 ^{④-②} APW1246 ^{④-②} APW1486 ^{④-②}
	Full Voltage	—	APW199 ^{④-②-③}
	Transformer	120VAC 240VAC 480VAC	APQW1B126 ^{④-②} APQW1B246 ^{④-②} APQW1B486 ^{④-②}
	Full Voltage	—	APQW1B99 ^{④-②-③}

- 1. In place of ②, specify the Lens color code from table below.
- 2. In place of ③, specify the full voltage code from table below.
- 3. In place of ④, specify the Lamp Type Code from table below.
- 4. For accessories, see page A-154.
- 5. For dimensions, see page A-156.
- 6. For sub-assembly part numbers, see next page.

② Lens Color Code

Color	Code
Amber	A
Green	G
Red	R
Blue	S
White	W
Yellow	Y

③ Full Voltage Code

LED
6 = 6V AC/DC
12 = 12V AC/DC
24 = 24V AC/DC
120 = 120V AC (LED only)
240 = 240V AC (LED only)

④ Lamp Type Code

Lamp	Code
Incandescent	Blank
LED	D

Pilot Lights (Sub-Assembled)

Transformer + Operator + Lamp + Lens = Complete Part

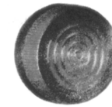

* Transformer not required for full voltage units.

Part Numbers: Pilot Light Operators

Style		Part Number
Round Dome/ Flush		APW-199
Square		UPQW-199



1. Bezel included with operator.
2. Lens, lamp, and transformer must be ordered separately when applicable.
3. Same operator is used for full voltage as for transformer completed units.

Part Numbers: Pilot Light Lenses

Style	Part Number	
	Non-Marking	Marking
Dome (Incandescent)	APW2L-②	—
Dome (LED)	APW2LD-②	—
Round Flush (Incandescent)	APW1LN-②	APW1BLN-②
Round Flush (LED)	APW1LD-②	APW1BLD-②
Square Flush	—	APQW1BL-②



1. In place of ②, specify the lens color code from table below.
2. Non-marking lenses have a ribbed lens to enhance light dispersion. Marking lenses include an engravable insert.
3. LED lenses are lighter in color than incandescent lenses in order to compensate for the inherent color of the LED.
4. Use incandescent lens when using blue LED.

② Lens/LED Color Code

Color	Code
Amber	A
Green	G
Red	R
Blue	S
White	W
Yellow	Y
Clear (white)	C (square & marking lenses only)

Part Numbers: Lamps

Type	Voltage	Current	Part Number
LED	6V AC/DC	20mA	LSTD-6-②
	12V AC/DC	20mA	LSTD-1-②
	24V AC/DC	20mA	LSTD-2-②
	120V AC	10mA	LSTD-H2②
	240V AC		LSTD-M4②
Incandescent	6.3V AC/DC, 1W		IS-6
	12V AC/DC, 1W		IS-12
	24V AC/DC, 1W		IS-24
	30V AC/DC, 1W		IS-30



1. In place of ②, specify the LED color code from table below.
2. The LED contains a current-limiting resistor and diode bridge.

Part Numbers: Transformers

Description	Appearance	Primary Voltage (50/60Hz)	Part Number
Transformers		Full Size	120V TW-T126
		240V	TW-T246
		480V	TW-T486
	Half Size		120V TW-T126S
		240V	TW-T246S



All Transformers step down to 6V.

Illuminated Pushbuttons (Assembled)



A

Assembled Illuminated Pushbuttons

A L () W 2 126 11 (D) (N) - R - ()

Degree of Protection

A: IP65

Function

L: Momentary Action
 OL: Alternate Action
 VL: Pushlock Turn Reset
 YL: Push-Pull

Bezel Shape

Blank: Octagonal
 F: Full Shroud
 Q: Square

Series Type

W: TW Ø 7/8" (Ø 22mm)

Lens Shape

2: Extended Non-Marking
 2B: Extended Marking
 4: Mushroom Ø 1-37/64" (Ø 40mm)
 4B: Mushroom Marking Ø 1-37/64" (Ø 40mm)

Rated Operational Voltage (Primary)

Transformer/AC Adaptor Type	Full Voltage Type
126:120V AC	99:Full Voltage
246:240V AC	
486:480V AC (Transformer type only)	

Lamp Voltage

(Full Voltage Only)

Incandescent
 6: 6V AC/DC
 12: 12V AC/DC
 24: 24V AC/DC
 LED
 6: 6V AC/DC
 12: 12V AC/DC
 24: 24V AC/DC
 120:120V AC
 240: 240V AC

Lens Code

A: Amber
 G: Green
 R: Red
 S: Blue
 C: Clear (square only)
 W: White
 Y: Yellow

Contact Style

Blank: Standard
 N: Fingersafe

Lamp Type

Blank: Incandescent Lamp

Contact Arrangement

10: 1NO	01: 1NC
20: 2NO	02: 2NC
11: 1NO-1NC	22:2NO-2NC



1. Use only when interpreting part numbers. Do not use for developing part numbers.

2. All AC Adaptors/Transformers step down to 6V.

Illuminated Pushbuttons (Assembled)

Part Numbers: Illuminated Pushbuttons

Style	Contacts	Part Number	
		Momentary	Maintained
Extended Lens AC Adaptor Type	1NO-1NC 2NO 2NC	ALW2 ④ 611⑤-② ALW2 ④ 620⑤-② ALW2 ④ 602⑤-②	AOLW2 ④ 611⑤-② AOLW2 ④ 620⑤-② AOLW2 ④ 602⑤-②
Extended Lens Full Voltage	1NO-1NC 2NO 2NC	ALW29911⑤-②-③ ALW29920⑤-②-③ ALW29902⑤-②-③	AOLW29911⑤-②-③ AOLW29920⑤-②-③ AOLW29902⑤-②-③
Extended Lens with Full Shroud AC Adaptor Type	1NO-1NC 2NO 2NC	ALFW2 ④ 611⑤-② ALFW2 ④ 620⑤-② ALFW2 ④ 602⑤-②	AOLFW2 ④ 611⑤-② AOLFW2 ④ 620⑤-② AOLFW2 ④ 602⑤-②
Extended Lens with Full Shroud Full Voltage	1NO-1NC 2NO 2NC	ALFW29911⑤-②-③ ALFW29920⑤-②-③ ALFW29902⑤-②-③	AOLFW29911⑤-②-③ AOLFW29920⑤-②-③ AOLFW29902⑤-②-③
Ø 1-37/64" (40mm) Mushroom Lens AC Adaptor Type	1NO-1NC 2NO 2NC	ALW4 ④ 611⑤-② ALW4 ④ 620⑤-② ALW4 ④ 602⑤-②	AOLW4 ④ 611⑤-② AOLW4 ④ 620⑤-② AOLW4 ④ 602⑤-②
Ø 1-37/64" (40mm) Mushroom Lens Full Voltage	1NO-1NC 2NO 2NC	ALW49911⑤-②-③ ALW49920⑤-②-③ ALW49902⑤-②-③	AOLW49911⑤-②-③ AOLW49920⑤-②-③ AOLW49902⑤-②-③
Square Extended AC Adaptor Type	1NO-1NC 2NO 2NC	ALQW2B ④ 611⑤-② ALQW2B ④ 620⑤-② ALQW2B ④ 602⑤-②	AOLQW2B ④ 611⑤-② AOLQW2B ④ 620⑤-② AOLQW2B ④ 602⑤-②
Square Extended Full Voltage	1NO-1NC 2NO 2NC	ALQW2B9911⑤-②-③ ALQW2B9920⑤-②-③ ALQW2B9902⑤-②-③	AOLQW2B9911⑤-②-③ AOLQW2B9920⑤-②-③ AOLQW2B9902⑤-②-③

② LED/Lens Color Code

Color	Code
Amber	A
Green	G
Red	R
Blue	S
White	W
Yellow	Y
Clear	C (square only)

③ Full Voltage Code

Voltage	Code
6V AC/DC	6
12V AC/DC	12
24V AC/DC	24
120V AC	120 (LED only)
240V AC	240 (LED only)

④ AC Adaptor /Transformer Voltage Codes

Voltage	Code
120VAC	12
240VAC	24
480VAC	48



AC Adaptor and Transformers step down to 6V.

⑤ Lamp Type Code

Lamp	Code
Incandescent	Blank
LED	D

Part Numbers: Illuminated Emergency Stop Pushbutton

Style	Contacts	Part Number
Ø 1-37/64" (40mm) Pushlock Turn Reset AC Adaptor Type	1NO-1NC 2NO 2NC	AVLW4 ④ 6115-R AVLW4 ④ 6205-R AVLW4 ④ 6025-R
Ø 1-37/64" (40mm) Pushlock Turn Reset Full Voltage (available in Red Only)	1NO-1NC 2NO 2NC	AVLW499115-R-③ AVLW499205-R-③ AVLW499025-R-③
Ø 1-37/64" (40mm) Push-Pull AC Adaptor Type	1NO-1NC 2NO 2NC	AYLW4 ④ 6115-② AYLW4 ④ 6205-② AYLW4 ④ 6025-②
Ø 1-37/64" (40mm) Push-Pull Full Voltage	1NO-1NC 2NO 2NC	AYLW499115-②-③ AYLW499205-②-③ AYLW499025-②-③



- In place of ②, specify the Lens color code (see table above).
- In place of ③, specify the full voltage code (lamp voltage) (see table above).
- In place of ④, specify the transformer voltage code (see table above).
- In place of ⑤, specify the Lamp Type code from table above.
- Small mushroom pushbutton lens, Ø 1-5/32" (29mm), is available by ordering Part No. ALW3L-② (non-marking) or ALW3BL-② (marking) separately.
- For sub-assembly part numbers, see page A-134.
- For accessories, see page A-154.
- For dimensions, see page A-156.

Illuminated Pushbuttons (Sub-Assembled)

Transformer/ Adaptor* + Contacts + Lamp Holder + Operator + Lamp + Lens = Complete Part

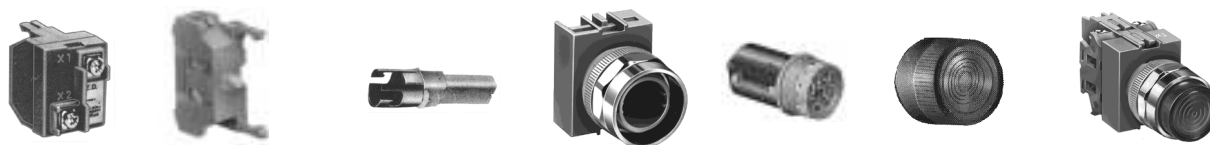



A

* Not applicable for full voltage units



Part Numbers: Operators

Style	Part Number	
	Momentary	Maintained
Extended	ALW-0600	AOLW-0600
Extended with Full Shroud	ALFW-0600	AOLFW-0600
Ø 1-37/64 (40mm) Mushroom	ALW3-0600	AOLW3-0600
Square Flush/Extended	ALQW-2B0600	AOLQW-2B0600
Ø 1-37/64" (40mm) Pushlock Turn Reset	—	AVLW3-0600
Ø 1-37/64" (40mm) Push-Pull	—	AYLW4-0600

Part Numbers: Transformers

Description	Appearance	Primary Voltage (50/60Hz)	Part Number
Transformers	 Full Size	120V	TW-T126
		240V	TW-T246
		480V	TW-T486
	 Half Size	120V	TW-T126S
240V		TW-T246S	

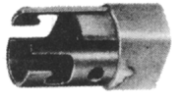
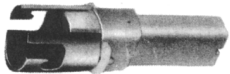
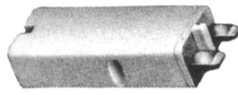

Part Numbers: Lamp Circuit Components

Style	Application	Part Number
Short Lamp Holder 	Used with a Half-size Transformer, or AC Adaptor and one contact block	TW-LH1
Long Lamp Holder 	Used with an AC Adaptor or Full-size Transformer and two contact blocks Used with Half-size Transformer and three contact blocks Used with Direct Voltage Adaptor and two contact blocks	TW-LH2
Lead Holder 	Used with TW-LH2 holder when using four contact blocks	TW-LH3
Full Voltage Adaptor 	All full voltage units.	TW-DA1B



All Transformers step down to 6V.

Part Numbers: Contact Blocks

Description	Part Number	
	1NO	1NC
Standard Exposed Screw 	HW-C10 HW-C10R (early make)	HW-C01 HW-C01R (late break)
Fingersafe (IP20), CE marked 	HW-F10 HW-F10R (early make)	HW-F01 HW-F01R (late break)
Dummy Block 	TW-DB	



1. Dummy blocks (no contacts) are used with an odd number of contact blocks.
2. Use of early and late break contacts creates a make before break function

Illuminated Pushbuttons (Sub-Assembled) con't



Part Numbers: Lenses

Style	Part Number	
	Non-Marking	Marking
Round Extended (Incandescent) 	ALW2L-②	ALW2BL-②
Round Extended (LED) 	ALW2LD-②	ALW2BLD-②
Square Extended 	—	ALQW2BL-②
Ø 1-37/64 (Ø 40mm) Mushroom 	ALW4L-②	ALW4BL-②
Ø 1-5/32 (Ø 29mm) Mushroom 	ALW3L-②	ALW3BL-②
Ø 1-37/64 (Ø 40mm) Pushlock Turn Reset 	AVLW4L-R	AVLW4BL-R
Ø 1-37/64 (Ø 40mm) Push Pull 	AYLW4L-②	AYLW4BL-②



In place of ②, specify the lens color code from table on the bottom right. When using blue LED, select blue incandescent lens.

Part Numbers: Lamps

Type	Voltage	Current	Part Number
LED 	6V AC	20mA	LSTD-6-②
	12V AC/DC	20mA	LSTD-1-②
	24V AC/DC	20mA	LSTD-2-②
	120V AC	10mA	LSTD-H2②
	240V AC		LSTD-M4②
Incandescent 	6.3V AC/DC, 1W		IS-6
	12V AC/DC, 1W		IS-12
	24V AC/DC, 1W		IS-24



- In place of ②, specify the LED color code.
- The LED contains a current-limiting resistor and a protection diodes.

② LED/Lens Color Code

Color	Code
Amber	A
Green	G
Red	R
Blue	S
White	W
Yellow	Y
Clear (white)	C (square only or marking lenses only)

Non-Illuminated Selector Switches (Assembled)



Knob type shown.

Assembled Selector Switches

A S W 3 1 L 20(N) -304

Degree of Protection

A: IP65 (IP40 for Key Type operators)

Function

S: Selector Switch

Series Type

W: TW Ø 7/8" (Ø 22mm)

Number of Positions

2: 2-Position

3: 3-Position

(4- and 5- position available sub-assembled; consult IDEC representative)

Spring Return Action

Blank: Maintained

1: Spring return from Right

2: Spring return from Left

3: 2-Way spring return from Left and Right

Circuit Number

(Standard circuits shown on following pages and A-146.)

Contacts Type

Blank: standard

N: Fingersafe

Contact Arrangement Code

10: 1NO 01: 1NC

20: 2NO 02: 2NC

40: 4NO 04: 4NC

11: 1NO-1NC 22: 2NO-2NC

Operator Style Code

Blank: Knob Operator

L: Lever Operator

K: Key Operator



1. Use only when interpreting part numbers. Do not use for developing part numbers.

2. Custom contact configurations available, contact IDEC for details.

Non-Illuminated Selector Switches (Assembled) con't

Part Numbers: 2-Position Selector Switches

Style				Part Number	Part Number	Part Number	
Contact	Mounting	Operator Position		Maintained 	Spring Return from Right 	Spring Return from Left 	
		L	R				
1NO	1	0	X	Knob Lever Key	ASW210 ASW2L10 ASW2K10	ASW2110 ASW21L10 ASW21K10	ASW2210 ASW22L10 ASW22K10
	2	0	0				
1NC	1	X	0	Knob Lever Key	ASW201-116 ASW2L01-116 ASW2K01-116	ASW2101-116 ASW21L01-116 ASW21K01-116	ASW2201-116 ASW22L01-116 ASW22K01-116
	2	0	0				
1NO 1NC	1	X	0	Knob Lever Key	ASW211 ASW2L11 ASW2K11	ASW2111 ASW21L11 ASW21K11	ASW2211 ASW22L11 ASW22K11
	2	0	X				
2NO	1	0	X	Knob Lever Key	ASW220 ASW2L20 ASW2K20	ASW2120 ASW21L20 ASW21K20	ASW2220 ASW22L20 ASW22K20
	2	0	X				
2NC	1	X	0	Knob Lever Key	ASW202-104 ASW2L02-104 ASW2K02-104	ASW2102-104 ASW21L02-104 ASW21K02-104	ASW2202-104 ASW22L02-104 ASW22K02-104
	2	X	0				
2NO 2NC	1	0	X	Knob Lever Key	ASW222 ASW2L22 ASW2K22	ASW2122 ASW21L22 ASW21K22	ASW2222 ASW22L22 ASW22K22
	2	X	0				
3	3	0	X	Knob Lever Key	ASW222 ASW2L22 ASW2K22	ASW2122 ASW21L22 ASW21K22	ASW2222 ASW22L22 ASW22K22
	4	X	0				
2NO 2NC	1	0	X	Knob Lever Key	ASW222-111 ASW2L22-111 ASW2K22-111	ASW2122-111 ASW21L22-111 ASW21K22-111	ASW2222-111 ASW22L22-111 ASW22K22-111
	2	0	X				
3	3	X	0	Knob Lever Key	ASW222-111 ASW2L22-111 ASW2K22-111	ASW2122-111 ASW21L22-111 ASW21K22-111	ASW2222-111 ASW22L22-111 ASW22K22-111
	4	X	0				

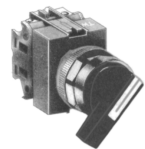

Part Numbers: 3-Position Selector Switches

Style					Part Number	Part Number	
Contact	Mounting	Operator Position			Maintained 	Spring Return from Right 	
		L	C	R			
2NO	1	X	0	0	Knob Lever Key	ASW320 ASW3L20 ASW3K20	ASW3120 ASW31L20 ASW31K20
	2	0	0	X			
2NC	1	0	X	X	Knob Lever Key	ASW302 ASW3L02 ASW3K02	ASW3102 ASW31L02 ASW31K02
	2	X	X	0			
2NO 2NC	1	X	0	0	Knob Lever Key	ASW322 ASW3L22 ASW3K22	ASW3122 ASW31L22 ASW31K22
	2	0	0	X			
3	3	0	X	X	Knob Lever Key	ASW322 ASW3L22 ASW3K22	ASW3122 ASW31L22 ASW31K22
	4	X	X	0			
2NO 2NC	1	X	0	X	Knob Lever Key	ASW322-309 ASW3L22-309 ASW3K22-309	ASW3122-309 ASW31L22-309 ASW31K22-309
	2	X	X	0			
3	3	0	X	X	Knob Lever Key	ASW322-309 ASW3L22-309 ASW3K22-309	ASW3122-309 ASW31L22-309 ASW31K22-309
	4	0	0	X			
2NO 2NC	1	0	X	0	Knob Lever Key	ASW322-310 ASW3L22-310 ASW3K22-310	ASW3122-310 ASW31L22-310 ASW31K22-310
	2	0	0	X			
3	3	0	X	X	Knob Lever Key	ASW322-310 ASW3L22-310 ASW3K22-310	ASW3122-310 ASW31L22-310 ASW31K22-310
	4	0	0	X			
4NO	1	X	0	0	Knob Lever Key	ASW340 ASW3L40 ASW3K40	ASW3140 ASW31L40 ASW31K40
	2	0	0	X			
3	3	X	0	0	Knob Lever Key	ASW340 ASW3L40 ASW3K40	ASW3140 ASW31L40 ASW31K40
	4	0	0	X			
4NC	1	0	X	X	Knob Lever Key	ASW304 ASW3L04 ASW3K04	ASW3104 ASW31L04 ASW31K04
	2	X	X	0			
3	3	0	X	X	Knob Lever Key	ASW304 ASW3L04 ASW3K04	ASW3104 ASW31L04 ASW31K04
	4	X	X	0			

Non-Illuminated Selector Switches (Assembled) con't

Part Numbers: 3-Position Selector Switches

Style					Part Number	Part Number	
Contact	Mounting	Operator Position				Spring Return from Left	Spring Return Two-Way
		L	C	R			
2NO	1	X	O	O	Knob Lever Key	ASW3220 ASW32L20 ASW32K20	ASW3320 ASW33L20 ASW33K20
	2	O	O	X			
2NC	1	O	X	X	Knob Lever Key	ASW3202 ASW32L02 ASW32K02	ASW3302 ASW33L02 ASW33K02
	2	X	X	O			
2NO 2NC	1	X	O	O	Knob Lever Key	ASW3222 ASW32L22 ASW32K22	ASW3322 ASW33L22 ASW33K22
	2	O	O	X			
	3	O	X	X			
	4	X	X	O			
2NO 2NC	1	X	O	X	Knob Lever Key	ASW3222-309 ASW32L22-309 ASW32K22-309	ASW3322-309 ASW33L22-309 ASW33K22-309
	2	X	X	O			
	3	O	X	O			
	4	O	O	X			
2NO 2NC	1	O	X	O	Knob Lever Key	ASW3222-310 ASW32L22-310 ASW32K22-310	ASW3322-310 ASW33L22-310 ASW33K22-310
	2	O	O	X			
	3	O	X	O			
	4	O	O	X			
4NO	1	X	O	O	Knob Lever Key	ASW3240 ASW32L40 ASW32K40	ASW3340 ASW33L40 ASW33K40
	2	O	O	X			
	3	X	O	O			
	4	O	O	X			
4NC	1	O	X	X	Knob Lever Key	ASW3204 ASW32L04 ASW32K04	ASW3304 ASW33L04 ASW33K04
	2	X	X	O			
	3	O	X	X			
	4	X	X	O			

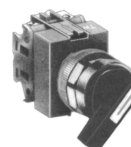

1. The truth table indicates the operating position of contact block when the operator is switched to that position.

X = On (closed contacts) O = Off (open contacts)

X-X = Overlapping Contacts: Remain on (closed contacts) when switch is moved between these two positions.

2. All knob and lever selector switches come in black. Other colors are available by ordering the knob or lever separately.

3. Every key selector switch uses an identical key. The key is removable in any maintained position. If a different configuration is required, contact an IDEC representative for more information.

4. Custom contact configurations are available, see page A-146 or contact IDEC for details.

Non-Illuminated Selector Switches (Sub-Assembled)



Contact Blocks + Operator + Knob or Lever * + Color Insert * = Complete Part †



1. * Not needed with key type switches.

2. † Knob type shown.

Part Numbers: Operators

Style	Positions	Description	Part Number
Knob/Lever 	2	Maintained	ASW200
		Spring return from right	ASW2100
		Spring return from left	ASW2200
	3	Maintained, Cam 1	ASW300-1
		Maintained, Cam 2	ASW300-2
		Maintained, Cam 3	ASW300-3
		Spring return from right, Cam 1	ASW3100-1
	Spring return from right, Cam 2	ASW3100-2	
	Spring return from left, Cam 1	ASW3200-1	
	Spring return from left, Cam 2	ASW3200-2	
4	Spring return from left/right, Cam 1	ASW3300-1	
	Spring return from left/right, Cam 2	ASW3300-2	
5	Maintained, Standard Cam	ASW400	
	Maintained, Cam 1	ASW400-1	
5	Maintained, Standard cam	ASW500	
	Maintained, Cam 1	ASW500-1	
Key 	2	Maintained	ASW2K00
		Spring return from right	ASW21K00
		Spring return from left	ASW22K00
	3	Maintained, Cam 1	ASW3K00-1
		Maintained, Cam 2	ASW3K00-2
		Maintained, Cam 3	ASW3K00-3
		Spring return from right, Cam 1	ASW31K00-1
	Spring return from right, Cam 2	ASW31K00-2	
	Spring return from left, Cam 1	ASW32K00-1	
	Spring return from left, Cam 2	ASW32K00-2	
3	Spring return from left/right, Cam 1	ASW33K00-1	
	Spring return from left/right, Cam 2	ASW33K00-2	



1. Two keys are supplied with every switch, all are keyed alike, and removable from any maintained position. For other configurations, consult your IDEC representative.

2. Locking rings are included with all operators. Order knobs, levers, and color inserts separately.

3. Different cams produce different contact actions. For details, see contact arrangement charts, page A-146.

Non-Illuminated Selector Switches (Sub- Assembled) con't

Part Numbers: Handles and Inserts



Style	Part Number
Knob 	ASWHHY-①
Lever 	ASWHHL-①
Color Insert 	TW-HC1-①

① Handle/Insert Color Code

Color	Code
Black*	B
Blue	S
Green	G
Red	R
Yellow	Y
White†	W

* Color inserts not available in black.
† Knob and lever not available in white.

Part Numbers: Contact Blocks

Style	Part Number	
	1NO	1NC
	HW-C10 HW-C10R (early make)	HW-C01 HW-C01R (late break)
Fingersafe (IP20), CE marked 	HW-F10 HW-F10R (early make)	HW-F01 HW-F01R (late break)
Dummy Block 	TW-DB	

-  1. Push rod color code: Green = NO contact block Red = NC contact block.
2. Dummy blocks (no contacts) are used with an odd number of contact blocks.

Illuminated Selector Switches (Assembled)

Assembled Illuminated Selector Switches
A SL W 2 2 126 11 D (N)- 202 - R - 24
Degree of Protection

A: IP65

Function

SL: Illuminated Selector Switch

Series Type

W: TW Ø 7/8" (Ø 22mm)

Number of Positions

2: 2-Position

3: 3-Position

Spring Return Action

Blank: Maintained

1: Spring return from Right

2: Spring return from Left

3: Two-Way spring return from Left & Right

Rated Operational Voltage (Primary)

Transformer/AC Adaptor Type

Full Voltage Type

126:120V AC

99:Full Voltage

246:240V AC

486:480V AC (*Transformer type only)

Lamp Voltage (Full Voltage Only)

Incandescent LED

6: 6V 6: 6V AC/DC

12: 12V 12: 12V AC/DC

24: 24V 24: 24V AC/DC

120:120V AC

Lens Color Code

A: Amber

G: Green

R: Red

S: Blue

W: White

Y: Yellow

Contact Circuit No.

Standard circuits are listed on the following pages and A-146.

Contacts Type

Blank: standard

N: Fingersafe

Lamp Type

Blank: Incandescent Lamp

D: LED Lamp

Contact Arrangement

20: 2NO 02: 2NC

40: 4NO 04: 4NC



1. Use only when interpreting part numbers. Do not use for developing part numbers.
2. All transformers and AC Adaptors step down to 6V.

Illuminated Selector Switches (Assembled) con't

Part Numbers: Illuminated 2-Position Selector Switches

Style				Part Number			
Contact	Mounting	Operator Position		Lamp Circuit Type	Maintained	Spring Return from Right	Spring Return from Left
		L	R				
1NO 1NC	1	O	X	Transformer Full Voltage	ASLW2 ① 611④-② ASLW29911④-②-③	ASLW21 ① 611④-② ASLW219911④-②-③	ASLW22 ① 611④-② ASLW229911④-②-③
	2	X	O				
2NO	1	O	X	Transformer Full Voltage	ASLW2 ① 620④-② ASLW29920④-②-③	ASLW21 ① 620④-② ASLW219920④-②-③	ASLW22 ① 620④-② ASLW229920④-②-③
	2	O	X				
2NC	1	X	O	Transformer Full Voltage	ASLW2 ① 602④-104-② ASLW29902④-104-②-③	ASLW21 ① 602④-104-② ASLW219902④-104-②-③	ASLW22 ① 602④-104-② ASLW229902④-104-②-③
	2	X	O				
2NO 2NC	1	O	X	Transformer Full Voltage	ASLW2 ① 622④-② ASLW29922④-②-③	ASLW21 ① 622④-② ASLW219922④-②-③	ASLW22 ① 622④-② ASLW229922④-②-③
	2	X	O				
	3	O	X				
	4	X	O				
2NO 2NC	1	O	X	Transformer Full Voltage	ASLW2 ① 622④-111-② ASLW29922④-111-②-③	ASLW21 ① 622④-111-② ASLW219922④-111-②-③	ASLW22 ① 622④-111-② ASLW229922④-111-②-③
	2	X	O				
	3	O	X				
	4	X	O				



1. In place of ①, specify the voltage code. In place of ②, specify the Lens color code. In place of ③, specify the Full Voltage code. In place of ④ specify Lamp Type code.
2. The truth table indicates the operating position of contact block when the operator is switched to that position.
X = On (Closed Contacts) O = Off (Open Contacts)
3. For custom contact configuration, see page A-146. Contact IDEC for details.

① Transformer Voltage Code

Voltage	Code
120V AC	12
240V AC	24
480V AC	48 (incandescent only)



Transformers step down to 6V.

② Lens Color Code

Color	Code
Amber	A
Green	G
Red	R
Blue	S
White	W
Yellow	Y

③ Full Voltage Code

Voltage	Code
6V DC	6
12V AC/DC	12
24V AC/DC	24
120V AC	120 (LED only)
240V AC	240 (LED only)

④ Lamp Type Code

Lamp	Code
Incandescent	Blank
LED	D

Illuminated Selector Switches (Assembled) con't

Part Numbers: Illuminated 3-Position Selector Switches Maintained and Spring Return from Right

Style		Operator Position			Lamp Circuit Type	Part Number	Part Number	Part Number	Part Number
Contact	Mounting	L	C	R		Maintained C L R	Spring Return From Right C L R	Spring Return from Left C L R	Spring Return Two-Way C L R
2NO	1	X	O	O	Transformer Full Voltage	ASLW3 ① 620④-② ASLW39920④-②-③	ASLW31 ① 620④-② ASLW319920④-②-③	ASLW32 ① 620④-② ASLW329920④-②-③	ASLW33 ① 620④-② ASLW339920④-②-③
	2	O	O	X					
2NC	1	O	X	X	Transformer Full Voltage	ASLW3 ① 602④-② ASLW39902④-②-③	ASLW31 ① 602④-② ASLW319902④-②-③	ASLW32 ① 602④-② ASLW329902④-②-③	ASLW33 ① 602④-② ASLW339902④-②-③
	2	X	X	O					
2NO	1	X	O	O	Transformer Full Voltage	ASLW3 ① 622④-② ASLW39922④-②-③	ASLW31 ① 622④-② ASLW319922④-②-③	ASLW32 ① 622④-② ASLW329922④-②-③	ASLW33 ① 622④-② ASLW339922④-②-③
	2	O	O	X					
2NC	3	O	X	X	Transformer Full Voltage	ASLW3 ① 622④-② ASLW39922④-②-③	ASLW31 ① 622④-② ASLW319922④-②-③	ASLW32 ① 622④-② ASLW329922④-②-③	ASLW33 ① 622④-② ASLW339922④-②-③
	4	X	X	O					
2NO	1	X	O	X	Transformer Full Voltage	ASLW3 ① 622④-309-② ASLW39922④-309-②-③	ASLW31 ① 622④-309-② ASLW319922④-309-②-③	ASLW32 ① 622④-309-② ASLW329922④-309-②-③	ASLW33 ① 622④-309-② ASLW339922④-309-②-③
	2	X	X	O					
2NC	3	O	X	O	Transformer Full Voltage	ASLW3 ① 622④-309-② ASLW39922④-309-②-③	ASLW31 ① 622④-309-② ASLW319922④-309-②-③	ASLW32 ① 622④-309-② ASLW329922④-309-②-③	ASLW33 ① 622④-309-② ASLW339922④-309-②-③
	4	O	O	X					
2NO	1	O	X	O	Transformer Full Voltage	ASLW3 ① 622④-310-② ASLW39922④-310-②-③	ASLW31 ① 622④-310-② ASLW319922④-310-②-③	ASLW32 ① 622④-310-② ASLW329922④-310-②-③	ASLW33 ① 622④-310-② ASLW339922④-310-②-③
	2	O	O	X					
2NC	3	O	X	O	Transformer Full Voltage	ASLW3 ① 622④-310-② ASLW39922④-310-②-③	ASLW31 ① 622④-310-② ASLW319922④-310-②-③	ASLW32 ① 622④-310-② ASLW329922④-310-②-③	ASLW33 ① 622④-310-② ASLW339922④-310-②-③
	4	O	O	X					
4NO	1	X	O	O	Transformer Full Voltage	ASLW3 ① 640④-② ASLW39940④-②-③	ASLW31 ① 640④-② ASLW319940④-②-③	ASLW32 ① 640④-② ASLW329940④-②-③	ASLW33 ① 640④-② ASLW339940④-②-③
	2	O	O	X					
4NC	3	X	O	O	Transformer Full Voltage	ASLW3 ① 640④-② ASLW39940④-②-③	ASLW31 ① 640④-② ASLW319940④-②-③	ASLW32 ① 640④-② ASLW329940④-②-③	ASLW33 ① 640④-② ASLW339940④-②-③
	4	O	O	X					
4NO	1	O	X	X	Transformer Full Voltage	ASLW3 ① 604④-② ASLW39904④-②-③	ASLW31 ① 604④-② ASLW319904④-②-③	ASLW32 ① 604④-② ASLW329904④-②-③	ASLW33 ① 604④-② ASLW339904④-②-③
	2	X	X	O					
4NC	3	O	X	X	Transformer Full Voltage	ASLW3 ① 604④-② ASLW39904④-②-③	ASLW31 ① 604④-② ASLW319904④-②-③	ASLW32 ① 604④-② ASLW329904④-②-③	ASLW33 ① 604④-② ASLW339904④-②-③
	4	X	X	O					



- In place of ①, specify the voltage code. In place of ②, specify the Lens/LED color code. In place of ③, specify the Full Voltage code.
- The truth table indicates the operating position of contact block when the operator is switched to that position.
X = On (Closed Contacts) O = Off (Open Contacts)
- For custom contact configuration, see page A-146. Contact IDEC for details.

① Transformer Voltage Code

Voltage	Code
120V AC	12
240V AC	24
480V AC	48



All transformers step down to 6V.

② Lens Color Code

Color	Code
Amber	A
Green	G
Red	R
Blue	S
White	W
Yellow	Y

③ Full Voltage Code

Voltage	Code
6V DC	6
12V AC/DC	12
24V AC/DC	24
120V AC	120 (LED only)
240V AC	240 (LED only)

④ Lamp Type Code

Lamp	Code
Incandescent	Blank
LED	D

Illuminated Selector Switches (Sub-Assembled)

Adaptor* + Contact Block + Operator + Lamp/Lead Holder † + Lamp + Lens = Complete Part

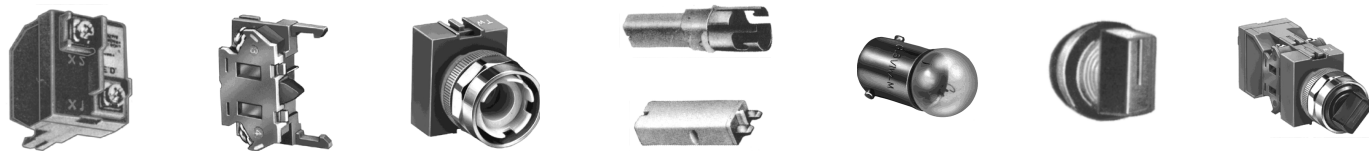

A

- 1. * AC adaptor is used with LED units, and a transformer is used with incandescent units
Full voltage LED, or incandescent units require a full voltage adaptor (TW-DA1).
- 2. † Lamp holder is not included with operators, order separately.
Lead holder is used when using 3 or more contact blocks. Order separately.

Part Numbers: Operators

Positions	Description	Part Number
2	Maintained	ASLW200
	Spring return from right	ASLW2100
	Spring return from left	ASLW2200
3	Maintained, cam 1 Maintained, cam 2 Maintained, cam 3	ASLW300-1 ASLW300-2 ASLW300-3
	Spring return from right, cam 1 Spring return from right, cam 2	ASLW3100-1 ASLW3100-2
	Spring return from left, cam 1 Spring return from left, cam 2	ASLW3200-1 ASLW3200-2
	Spring return from left/right, cam 1 Spring return from left/right, cam 2	ASLW3300-1 ASLW3300-2

Different cams produce different contact action. For details, Contact Arrangements on page A-146.

Part Numbers: Lamps (LED)

Type	Voltage	Current	Part Number
LED	6V AC	20mA	LSTD-6-②
	12V AC/DC	20mA	LSTD-1-②
	24V AC/DC	20mA	LSTD-2-②
	120V AC	10mA	LSTD-H2②
	240V AC		LSTD-M4②
Incandescent	6.3V AC/DC, 1W		IS-6
	12V AC/DC, 1W		IS-12
	24V AC/DC, 1W		IS-24

- 1. In place of ②, specify the LED color code.
- 2. The LED contains a current-limiting resistor and a protection diodes.

Part Numbers: Lenses (Knobs)

Description	Part Number
Knob (Incandescent)	ASLWLD-②
Knob (LED)	ASLWDDY-②



LED Knobs are lighter in color than incandescent knobs, in order to compensate for the inherent color of the LED. Use an incandescent lens, when using blue LEDs

② LED/Lens Color Code

Color	Code
Green	G
Red	R
Blue	S
White	W
Yellow	Y
Amber	A

Illuminated Selector Switches (Sub-Assembled) con't



Part Numbers: Contact Blocks

Description	Part Number	
	1NO	1NC
Standard Exposed Screw 	HW-C10 HW-C10R (early make)	HW-C01 HW-C01R (late break)
Fingersafe (IP20), CE marked 	HW-F10 HW-F10R (early make)	HW-F01 HW-F01R (late break)
Dummy Block 	TW-DB	

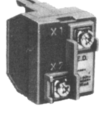
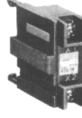

1. Dummy blocks (no contacts) are used with an odd number of contact blocks.
2. Use of early and late break contacts creates a make before break function

Part Numbers: Transformers

Description	Appearance	Primary Voltage (50/60Hz)	Part Number
Transformers	Full Size 	120V	TW-T126
		240V	TW-T246
		480V	TW-T486
	Half Size 	120V	TW-T126S
		240V	TW-T246S
		Full Voltage Adaptor 	Used with all full voltage units



All Transformers step down to 6V.

Part Numbers: Lamp Circuit Components

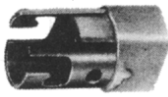
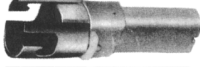
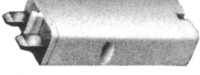
Style	Application	Part Number
Short Lamp Holder 	Used with a Half-size Transformer, or AC Adaptor and one contact block	TW-LH1
Long Lamp Holder 	Used with an AC Adaptor or Full-size Transformer and two contact blocks Used w/Half-size Transformer and three contact blocks Used w/Direct Voltage Adaptor and two contact blocks	TW-LH2
Lead Holder 	Used w/TW-LH2 holder when using four contact blocks	TW-LH3



Contact Arrangement Charts

How to Read Contact Arrangement Charts

To determine contact block mounting position, first make sure the selector switch is oriented as shown on the right

Contact Arrangement

Type and quantity of switch contacts

Circuit Number

* N/D = No designation required

Contact Block Mounting

Position or mounting contact blocks on operator

Operator Position

Truth table indicates the operating position of contact block when operator is switched to that position.

X = On (Closed Contacts)
O = Off (Open Contacts)
X-X = Overlapping Contacts: Remain on (closed) when switch is moved between these two positions

Contact Block Part Number

Part number to use when ordering sub-assembly contact blocks, as required for use with corresponding mounting position

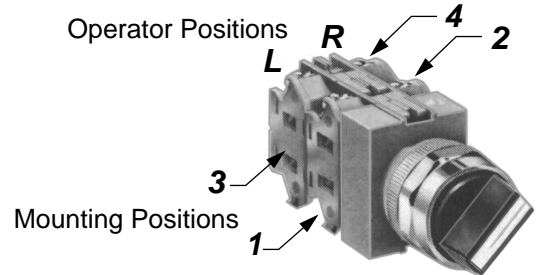

Style		Mounting Position	Operator Position		Contact Block Part Number	Description	Operator Part Number		
Contact	Circuit Number		L	R			Maintained	Spring Return from Right	Spring Return from Left
			↙	↘			↙↘	↙↘	
1NO	N/D	1	O	X	TW-C10	Knob/Lever Key Illuminated Knob	ASW200	ASW2100	ASW2200
		2	O	O	TW-D		ASW2K00	ASW21K00	ASW22K00
1NC	116	1	X	O	TW-C01	Knob/Lever Key Illuminated Knob	ASW200	ASW2100	ASW2200
		2	O	O	TW-D		ASW2K00	ASW21K00	ASW22K00
1NO 1NC	N/D	1	O	X	TW-C10	Knob/Lever Key Illuminated Knob	ASW200	ASW2100	ASW2200
		2	X	O	TW-C01		ASW2K00	ASW21K00	ASW22K00
	103	1	X	O	TW-C01	Knob/Lever Key Illuminated Knob	ASW200	ASW2100	ASW2200
		2	O	X	TW-C10		ASW2K00	ASW21K00	ASW22K00
EM LB	600	1	O	X	TW-C10R	Knob/Lever Key Illuminated Knob	ASW200	ASW2100	ASW2200
		2	X	O	TW-C01R		ASW2K00	ASW21K00	ASW22K00
	601	1	X	O	TW-C01R	Knob/Lever Key Illuminated Knob	ASW200	ASW2100	ASW2200
		2	O	X	TW-C10R		ASW2K00	ASW21K00	ASW22K00

1. NO-EM NC-LB = Early Make, Late Break.
 N/D = No circuit number designation required in assembled selector switch part number.
 2. X = On (closed contacts) O = Off (Open contacts)

Contact Arrangement Chart: 2-Position Selector Switches

Style		Mounting Position	Operator Position		Contact Block Part Number	Description	Operator Part Number		
Contact	Circuit Number		L	R			Maintained	Spring Ret. from Rt.	Spring Ret. from Lt.
			L	R					
1NO	N/D	1	0	X	TW-C10	Knob/Lever Key	ASW200	ASW2100	ASW2200
		2	0	0	TW-DB	Illuminated Knob	ASW2K00 ASLW200	ASW21K00 ASLW2100	ASW22K00 ASLW2200
1NC	116	1	X	0	TW-C01	Knob/Lever Key	ASW200	ASW2100	ASW2200
		2	0	0	TW-DB	Illuminated Knob	ASW2K00 ASLW200	ASW21K00 ASLW2100	ASW22K00 ASLW2200
1NO 1NC	N/D	1	0	X	TW-C10	Knob/Lever Key	ASW200	ASW2100	ASW2200
		2	X	0	TW-C01	Illuminated Knob	ASW2K00 ASLW200	ASW21K00 ASLW2100	ASW22K00 ASLW2200
	103	1	X	0	TW-C01	Knob/Lever Key	ASW200	ASW2100	ASW2200
		2	0	X	TW-C10	Illuminated Knob	ASW2K00 ASLW200	ASW21K00 ASLW2100	ASW22K00 ASLW2200
EM LB	600	1	0	X	TW-C10R	Knob/Lever Key	ASW200	ASW2100	ASW2200
		2	X	0	TW-C01R	Illuminated Knob	ASW2K00 ASLW200	ASW21K00 ASLW2100	ASW22K00 ASLW2200
	601	1	X	0	TW-C01R	Knob/Lever Key	ASW200	ASW2100	ASW2200
		2	0	X	TW-C10R	Illuminated Knob	ASW2K00 ASLW200	ASW21K00 ASLW2100	ASW22K00 ASLW2200
2NO	N/D	1	0	X	TW-C10	Knob/Lever Key	ASW200	ASW2100	ASW2200
		2	0	X	TW-C10	Illuminated Knob	ASW2K00 ASLW200	ASW21K00 ASLW2100	ASW22K00 ASLW2200
2NC	104	1	X	0	TW-C01	Knob/Lever Key	ASW200	ASW2100	ASW2200
		2	X	0	TW-C01	Illuminated Knob	ASW2K00 ASLW200	ASW21K00 ASLW2100	ASW22K00 ASLW2200
2NO 2NC	N/D	1	0	X	TW-C10	Knob/Lever Key Illuminated Knob	ASW200 ASW2K00 ASLW200	ASW2100 ASW21K00 ASLW2100	ASW2200 ASW22K00 ASLW2200
		2	X	0	TW-C01				
		3	0	X	TW-C10				
		4	X	0	TW-C01				
	110	1	X	0	TW-C01	Knob/Lever Key Illuminated Knob	ASW200 ASW2K00 ASLW200	ASW2100 ASW21K00 ASLW2100	ASW2200 ASW22K00 ASLW2200
		2	0	X	TW-C10				
		3	X	0	TW-C01				
		4	0	X	TW-C10				
	111	1	0	X	TW-C10	Knob/Lever Key Illuminated Knob	ASW200 ASW2K00 ASLW200	ASW2100 ASW21K00 ASLW2100	ASW2200 ASW22K00 ASLW2200
		2	0	X	TW-C10				
		3	X	0	TW-C01				
		4	X	0	TW-C01				
	117	1	X	0	TW-C01	Knob/Lever Key Illuminated Knob	ASW200 ASW2K00 ASLW200	ASW2100 ASW21K00 ASLW2100	ASW2200 ASW22K00 ASLW2200
		2	0	X	TW-C10				
		3	0	X	TW-C10				
		4	X	0	TW-C01				
4NO	105	1	0	X	TW-C10	Knob/Lever Key Illuminated Knob	ASW200 ASW2K00 ASLW200	ASW2100 ASW21K00 ASLW2100	ASW2200 ASW22K00 ASLW2200
		2	0	X	TW-C10				
		3	0	X	TW-C10				
		4	0	X	TW-C10				

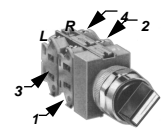

1. NO-EM NC-LB = Early Make, Late Break.

N/D = No circuit number designation required in assembled selector switch part number.

2. X = On (closed contacts) O = Off (Open contacts)

Contact Arrangement Chart: 3-Position Selector Switches

Style		Mounting Position	Operator Position			Contact Block Part Number	Description	Operator Part Number			
Contact	Circuit Number		L	C	R			Maintained	Spring Ret. from Rt.	Spring Ret. from Lt.	Two-Way
1NO 1NC	202	1	X	0	0	TW-C10	Knob/Lever Key Illuminated Knob	ASW300-1 ASW3K00-1 ASLW300-1	ASW3100-1 ASW31K00-1 ASLW3100-1	ASW3200-1 ASW32K00-1 ASLW3200-1	ASW3300-1 ASW33K00-1 ASLW3200-1
		2	X	X	0	TW-C01		ASW300-1 ASW3K00-1 ASLW300-1	ASW3100-1 ASW31K00-1 ASLW3100-1	ASW3200-1 ASW32K00-1 ASLW3200-1	ASW3300-1 ASW33K00-1 ASLW3200-1
	203	1	0	X	X	TW-C01	Knob/Lever Key Illuminated Knob	ASW300-1 ASW3K00-1 ASLW300-1	ASW3100-1 ASW31K00-1 ASLW3100-1	ASW3200-1 ASW32K00-1 ASLW3200-1	ASW3300-1 ASW33K00-1 ASLW3200-1
		2	0	0	X	TW-C10		ASW300-1 ASW3K00-1 ASLW300-1	ASW3100-1 ASW31K00-1 ASLW3100-1	ASW3200-1 ASW32K00-1 ASLW3200-1	ASW3300-1 ASW33K00-1 ASLW3200-1
	302	1	X	0	X	TW-C10	Knob/Lever Key Illuminated Knob	ASW300-2 ASW3K00-2 ASLW300-2	ASW3100-2 ASW31K00-2 ASLW3100-2	ASW3200-2 ASW32K00-2 ASLW3200-2	ASW3300-2 ASW33K00-2 ASLW3200-2
		2	X	X	0	TW-C01		ASW300-2 ASW3K00-2 ASLW300-2	ASW3100-2 ASW31K00-2 ASLW3100-2	ASW3200-2 ASW32K00-2 ASLW3200-2	ASW3300-2 ASW33K00-2 ASLW3200-2
	303	1	0	X	0	TW-C01	Knob/Lever Key Illuminated Knob	ASW300-2 ASW3K00-2 ASLW300-2	ASW3100-2 ASW31K00-2 ASLW3100-2	ASW3200-2 ASW32K00-2 ASLW3200-2	ASW3300-2 ASW33K00-2 ASLW3200-2
		2	0	0	X	TW-C10		ASW300-2 ASW3K00-2 ASLW300-2	ASW3100-2 ASW31K00-2 ASLW3100-2	ASW3200-2 ASW32K00-2 ASLW3200-2	ASW3300-2 ASW33K00-2 ASLW3200-2
	2NO	N/D	1	X	0	0	TW-C10	Knob/Lever Key Illuminated Knob	ASW300-1 ASW3K00-1 ASLW300-1	ASW3100-1 ASW31K00-1 ASLW3100-1	ASW3200-1 ASW32K00-1 ASLW3200-1
2			0	0	X	TW-C10	ASW300-1 ASW3K00-1 ASLW300-1		ASW3100-1 ASW31K00-1 ASLW3100-1	ASW3200-1 ASW32K00-1 ASLW3200-1	ASW3300-1 ASW33K00-1 ASLW3200-1
301		1	X	0	X	TW-C10	Knob/Lever Key Illuminated Knob	ASW300-2 ASW3K00-2 ASLW300-2	ASW3100-2 ASW31K00-2 ASLW3100-2	ASW3200-2 ASW32K00-2 ASLW3200-2	ASW3300-2 ASW33K00-2 ASLW3200-2
		2	0	0	X	TW-C10		ASW300-2 ASW3K00-2 ASLW300-2	ASW3100-2 ASW31K00-2 ASLW3100-2	ASW3200-2 ASW32K00-2 ASLW3200-2	ASW3300-2 ASW33K00-2 ASLW3200-2
2NC	304	1	0	X	0	TW-C01	Knob/Lever Key Illuminated Knob	ASW300-2 ASW3K00-2 ASLW300-2	ASW3100-2 ASW31K00-2 ASLW3100-2	ASW3200-2 ASW32K00-2 ASLW3200-2	ASW3300-2 ASW33K00-2 ASLW3200-2
		2	X	X	0	TW-C01		ASW300-2 ASW3K00-2 ASLW300-2	ASW3100-2 ASW31K00-2 ASLW3100-2	ASW3200-2 ASW32K00-2 ASLW3200-2	ASW3300-2 ASW33K00-2 ASLW3200-2
	N/D	1	0	X	X	TW-C01	Knob/Lever Key Illuminated Knob	ASW300-1 ASW3K00-1 ASLW300-1	ASW3100-1 ASW31K00-1 ASLW3100-1	ASW3200-1 ASW32K00-1 ASLW3200-1	ASW3300-1 ASW33K00-1 ASLW3200-1
		2	X	X	0	TW-C01		ASW300-1 ASW3K00-1 ASLW300-1	ASW3100-1 ASW31K00-1 ASLW3100-1	ASW3200-1 ASW32K00-1 ASLW3200-1	ASW3300-1 ASW33K00-1 ASLW3200-1
2NO 2NC	N/D	1	X	0	0	TW-C10	Knob/Lever Key Illuminated Knob	ASW300-1 ASW3K00-1 ASLW300-1	ASW3100-1 ASW31K00-1 ASLW3100-1	ASW3200-1 ASW32K00-1 ASLW3200-1	ASW3300-1 ASW33K00-1 ASLW3200-1
		2	0	0	X	TW-C10					
		3	0	X	X	TW-C01					
		4	X	X	0	TW-C01					
	210	1	0	X	X	TW-C01	Knob/Lever Key Illuminated Knob	ASW300-1 ASW3K00-1 ASLW300-1	ASW3100-1 ASW31K00-1 ASLW3100-1	ASW3200-1 ASW32K00-1 ASLW3200-1	ASW3300-1 ASW33K00-1 ASLW3200-1
		2	0	0	X	TW-C10					
		3	0	X	X	TW-C01					
		4	0	0	X	TW-C10					
	308	1	X	0	X	TW-C10	Knob/Lever Key Illuminated Knob	ASW300-2 ASW3K00-2 ASLW300-2	ASW3100-2 ASW31K00-2 ASLW3100-2	ASW3200-2 ASW32K00-2 ASLW3200-2	ASW3300-2 ASW33K00-2 ASLW3200-2
		2	X	X	0	TW-C01					
		3	X	0	X	TW-C10					
		4	X	X	0	TW-C01					
	309	1	X	0	X	TW-C10	Knob/Lever Key Illuminated Knob	ASW300-2 ASW3K00-2 ASLW300-2	ASW3100-2 ASW31K00-2 ASLW3100-2	ASW3200-2 ASW32K00-2 ASLW3200-2	ASW3300-2 ASW33K00-2 ASLW3200-2
		2	X	X	0	TW-C01					
		3	0	X	0	TW-C01					
		4	0	0	X	TW-C10					
310	1	0	X	0	TW-C01	Knob/Lever Key Illuminated Knob	ASW300-2 ASW3K00-2 ASLW300-2	ASW3100-2 ASW31K00-2 ASLW3100-2	ASW3200-2 ASW32K00-2 ASLW3200-2	ASW3300-2 ASW33K00-2 ASLW3200-2	
	2	0	0	X	TW-C10						
	3	0	X	0	TW-C01						
	4	0	0	X	TW-C10						
4NO	N/D	1	X	0	0	TW-C10	Knob/Lever Key Illuminated Knob	ASW300-1 ASW3K00-1 ASLW300-1	ASW3100-1 ASW31K00-1 ASLW3100-1	ASW3200-1 ASW32K00-1 ASLW3200-1	ASW3300-1 ASW33K00-1 ASLW3200-1
		2	0	0	X	TW-C10					
		3	X	0	0	TW-C10					
		4	0	0	X	TW-C10					
	305	1	X	0	X	TW-C10	Knob/Lever Key Illuminated Knob	ASW300-2 ASW3K00-2 ASLW300-2	ASW3100-2 ASW31K00-2 ASLW3100-2	ASW3200-2 ASW32K00-2 ASLW3200-2	ASW3300-2 ASW33K00-2 ASLW3200-2
		2	0	0	X	TW-C10					
		3	X	0	X	TW-C10					
		4	0	0	X	TW-C10					
4NC	N/D	1	0	X	X	TW-C01	Knob/Lever Key Illuminated Knob	ASW300-1 ASW3K00-1 ASLW300-1	ASW3100-1 ASW31K00-1 ASLW3100-1	ASW3200-1 ASW32K00-1 ASLW3200-1	ASW3300-1 ASW33K00-1 ASLW3200-1
		2	X	X	0	TW-C01					
		3	0	X	X	TW-C01					
		4	X	X	0	TW-C01					
	314	1	0	X	0	TW-C01	Knob/Lever Key Illuminated Knob	ASW300-2 ASW3K00-2 ASLW300-2	ASW3100-2 ASW31K00-2 ASLW3100-2	ASW3200-2 ASW32K00-2 ASLW3200-2	ASW3300-2 ASW33K00-2 ASLW3200-2
		2	X	X	0	TW-C01					
		3	0	X	0	TW-C01					
		4	X	X	0	TW-C01					

- Each operator sub-assembly is available as a "-1" and a "-2" for 3-position selector switches. The internal cam of a "-1" is different from that of a "-2". This results in designated combinations of open and closed contacts in the various operator positions.
- N/D = No circuit number designation required in assembled part number.
- X = On (closed contacts) O = Off (open contacts). X-X Overlapping contacts remain on (closed) when switch is moved between these two positions.

Custom Selector Switch Building Guide

To build a custom selector switch, follow these steps.

Step 1: How many positions of the switch are needed?

of positions
(2, 3, 4, 5)

Step 2: How many contacts should there be?

of isolated contacts
(maximum 6)

Step 3: Fill in the Truth Table

(X = closed, 0 = open)

		Knob Position				
		1	2	3	4	5
Contact	1					
	2					
	3					
	4					
	5					
	6					

Step 4: If building a 2 position selector, skip this step. (2 position selectors have only one cam)

If building a 3, 4, or 5 position selector, determine appropriate cam as follows:

Look at Row 1 from above table and locate an identical row in the operator truth tables (See next page).

Repeat for all rows. The user must find one operator that contains all rows from above table.

Record the operator cam version.

Operator CAM Version
 (-1, -2, -3 for 3 position)
 ("blank", -1 for 4 position)
 ("blank", -1 for 5 position)

Step 5: Build by placing appropriate contact in appropriate mounting position for each desired row on operator cam truth table. "L" and "R" refer to mounting on left or right side of operator as viewed from the front of the panel.

Caution: Before putting any custom selector switch into use, the user should use an ohmmeter to test for desired performance.



1. For Operator Truth Tables, see next page.
2. For examples of how to assemble selector switches, see A-106

Operator Truth Tables

Use the following tables to build custom selector switches.

2 Position Selector Switches

A

ASW200
ASLW200
ASW2K00

Contact	Mounting Position	Operator Position	
		Left	Right
TW-C10 (NO)	L	0	X
	R	0	X
TW-C01 (NC)	L	X	0
	R	X	0
TW-C10R NO-(EM)	L	0	X
	R	0	X
TW-C01R NC-(LB)	L	X	0
	R	X	0

3 Position Selector Switches

ASW300-1
ASW3K00-1
ASLW300-1

Contact	Mounting Position	Operator Position		
		Left	Center	Right
TW-C10 (NO)	L	X	0	0
	R	0	0	X
TW-C01 (NC)	L	0	X	X
	R	X	X	0
TW-C10R NO-(EM)	L	X	0	0
	R	0	0	X
TW-C01R NC-(LB)	L	0	X	X
	R	X	X	0

ASW300-2
ASW3K00-2
ASLW300-2

Contact	Mounting Position	Operator Position		
		Left	Center	Right
TW-C10 (NO)	L	X	0	X
	R	0	0	X
TW-C01 (NC)	L	0	X	0
	R	X	X	0
TW-C10R NO-(EM)	L	X	0	X
	R	0	0	X
TW-C01R NC-(LB)	L	0	X	0
	R	X	X	0

ASW300-3
ASW3K00-3
ASLW300-3

Contact	Mounting Position	Operator Position		
		Left	Center	Right
TW-C10 (NO)	L	X	0	0
	R	0	0	X
TW-C01 (NC)	L	0	X	0
	R	0	X	0
TW-C10R NO-(EM)	L	X	0	X
	R	X	0	X
TW-C01R NC-(LB)	L	0	X	X
	R	X	X	0



1. For Operator Truth Tables, see next page.
2. For examples of how to assemble selector switches, see A-106.

Operator Truth Tables con't

4 Position Selector Switches

ASW400

Contact	Mounting Position	Operator Position			
		1	2	3	4
TW-C10 (NO)	L	X	0	0	0
	R	0	X	0	0
TW-C01 (NC)	L	0	X	X	X
	R	X	0	X	X
TW-C10R NO-(EM)	L	X	0	0	0
	R	0	X	0	0
TW-C01R NC-(LB)	L	0	X	X	X
	R	X	0	X	X

ASW400-1

Contact	Mounting Position	Operator Position			
		1	2	3	4
TW-C10 (NO)	L	X	0	0	0
	R	0	0	0	X
TW-C01 (NC)	L	0	0	X	0
	R	0	X	0	0
TW-C10R NO-(EM)	L	X	X	0	X
	R	X	0	X	X
TW-C01R NC-(LB)	L	0	X	X	X
	R	X	X	X	0

5 Position Selector Switches

ASW500

Contact	Mounting Position	Operator Position				
		1	2	3	4	5
TW-C10 (NO)	L	X	0	0	0	0
	R	0	X	0	0	0
TW-C01 (NC)	L	0	0	X	X	X
	R	0	0	0	X	X
TW-C10R NO-(EM)	L	X	0	0	0	0
	R	0	X	0	0	0
TW-C01R NC-(LB)	L	0	X	X	X	X
	R	X	0	X	X	X

ASW500-1

Contact	Mounting Position	Operator Position				
		1	2	3	4	5
TW-C10 (NO)	L	X	0	0	0	0
	R	0	0	0	0	X
TW-C01 (NC)	L	0	0	0	X	0
	R	0	X	0	0	0
TW-C10R NO-(EM)	L	X	X	X	0	X
	R	X	0	X	X	X
TW-C01R NC-(LB)	L	0	X	X	X	X
	R	X	X	X	X	0



1. For Operator Truth Tables, see next page.
2. For examples of how to assemble selector switches, see A-106.

Nameplates — TW Series

Part Numbers: Nameplates

	NWAL	NWAQL	NWAS	EMERGENCY STOP †
Nameplate (blank)	NWAL-0B (black) NWAL-OR (red)	NWAQL-0B (black) NWAQL-OR (red)	NWAS-0B	NWAR-0
Nameplate (engraved)	NWAL-①	NWAQL-①	NWAS-①	NWAR-27†

1. In place of ①, insert either the standard legend code from table below or custom engraving delimited by “ ”.
2. Standard engravings are available at no charge.
3. NWAR-27 comes engraved “Emergency Stop” as shown in drawing.

Standard Legend Codes

Pushbuttons				Pushbuttons/Selector Switches				Selector Switches	
Legend	Code	Legend	Code	Legend	Code	Legend	Code	Legend	Code
AUTO	101	OPEN	116	AUTO-MAN	201			AUTO-MAN-OFF	301
CLOSE	102	OUT	117	CLOSE-OPEN	202			AUTO-OFF-MAN	302
DOWN	103	RAISE	118	DOWN-UP	203			CLOSE-OFF-OPEN	303
EMERG.STOP*	104	RESET	119	FAST-SLOW	204			DOWN-OFF-SLOW	304
FAST	105	REVERSE	120	FOR-REV	205	REV-FOR	216	FAST-OFF-SLOW	305
FORWARD	106	RUN	121	HAND-AUTO	206	RUN-JOG	217	FOR-OFF-REV	306
HAND	107	SLOW	122	HIGH-LOW	207	RUN-SAFE	218	LEFT-OFF-RIGHT	307
HIGH	108	START	123	JOG-RUN	208	SAFE-RUN	219	LOWER-OFF-RAISE	308
IN	109	STOP*	124	LEFT-RIGHT	209	SLOW-FAST	220	OFF-MAN-AUTO	309
INCH	110	STOP	125	LOWER-RAISE	210	START-STOP	221	OFF-SLOW-FAST	310
JOG	111	TEST	126	MAN-AUTO	211	STOP-START	222	OFF-1-2	311
LOW	112	UP	127	OFF-ON	212	UP-DOWN	223	OPEN-OFF-CLOSE	312
LOWER	113	I (Int'l On)	150	ON-OFF	213			SLOW-OFF-FAST	313
OFF	114	O (Int'l Off)	151	OPEN-CLOSE	214			SUMMER-OFF-WINTER	314
ON	115	EMO	152	RAISE-LOWER	215			UP-OFF-DOWN	315
								1-OFF-2	316
								HAND-OFF-AUTO	317

1. To order engraved nameplates, add legend code to nameplate part number.
Character height based on the number of characters and size of nameplate. Standard character size is 3/16".
2. Nameplates with standard legends are the same list price as blank nameplates.
3. * Available in red as standard.

Nameplate Order Form on next page.

Custom Engraved Nameplates Order Form — TW Series

Copy this order form and use it to specify Letter Height, Custom Engravings, Location of Engraving on Nameplate, and Quantity Desired. To insure engraving accuracy, fax it to your IDEC representative.

Your Company Name: _____
 Your Name: _____
 Telephone: _____

IDEC Representative(if known): _____
 PO number (if known): _____

NWAL

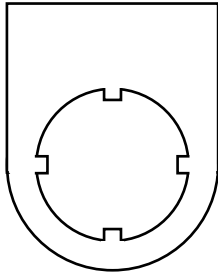
<p>Step 1. Specify letter height and custom engraving. Maximum of 2 lines of engraving.</p> <p>1/8" SAMPLE LETTERING Size (9 characters maximum)</p> <p>----- -----</p> <hr/> <p>7/64" SAMPLE LETTERING (11 characters maximum)</p> <p>----- ----- -----</p>	<p>Step 2. Specify location of engraving on NWAL namePlate.</p> 	<p>Step 3. Specify Quantity. Enter the number of nameplates desired with the specifications defined to the left.</p> <div style="border: 1px solid black; width: 60px; height: 40px; margin: 0 auto;"></div>
--	---	--



NWAQL

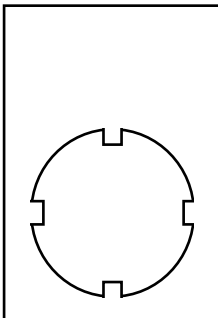



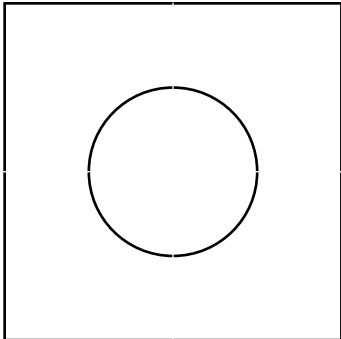



<p>Step 1. Specify letter height and custom engraving. Maximum of 2 lines of engraving.</p> <p>1/8" SAMPLE LETTERING Size (9 characters maximum)</p> <p>----- -----</p> <hr/> <p>7/64" SAMPLE LETTERING (11 characters maximum)</p> <p>----- ----- -----</p>	<p>Step 2. Specify location of engraving on NWAQL namePlate.</p> 	<p>Step 3. Specify Quantity. Enter the number of nameplates desired with the specifications defined to the left.</p> <div style="border: 1px solid black; width: 60px; height: 40px; margin: 0 auto;"></div>
--	---	--

NWAS

<p>Step 1. Specify letter height and custom engraving.</p> <p style="text-align: center;">Maximum of 1 line of engraving.</p>	<p>Step 2. Specify location of engraving on NWAS nameplate.</p> 
<p>1/8" SAMPLE LETTERING Size (14 characters maximum)</p> <p>-----</p> <hr/> <p>3/32" SAMPLE LETTERING Size (20 characters maximum)</p> <p>----- -----</p>	<p>Step 3. Specify Quantity Enter the number of nameplates desired with the specifications defined to the left.</p> <div style="border: 1px solid black; width: 60px; height: 40px; margin: 0 auto;"></div>

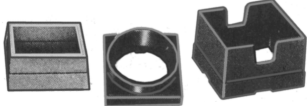
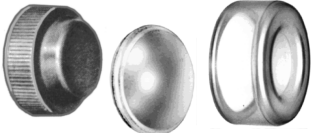
Accessories — TW Series



Part Numbers: TW Series Accessories

Appearance	Description/Usage		Part Number
Locking Ring Wrench 	Rubber tool used to tighten round bezels from the front of the panel Units with round bezels, will not work with octagonal bezels		OR-14
Lamp Removal Tool 	Rubber tool used to install LED's and incandescent lamps		OR-55
Contact Block Remover 	Used to remove contact blocks, transformers, lenses, and adaptors. Can also be used to determine panel thickness adjustment.		TW-KC1
Nut Locking Wrench 	Used in OR-14 locking wrench to tighten locking nuts inside square bezel		TW-KQ2
Metal Bezel 	Chrome plated bezels tighten onto operator (replacement for damaged bezels)	Standard octagonal units (chrome-pl.)	AW-R8
		Full shroud octagonal units (chrome-pl.)	AW-RF8
		Full shroud mushroom units Ø 1-37/64" (40mm)	AW-G4
Plastic Bezel 	Black plastic bezels for square buttons (replacement for damaged bezels)	Round flush units (black plastic)	AW-RP1B
		Round extended units (black plastic)	AW-FP1B
		Square units (black plastic)	AW-Q1B
		Square bezel with round hole (black plastic)	AW-H1B
		Square units with full shroud (black plastic)	AW-QF1B
Boot/Cover 	Used to cover and protect pushbuttons	Waterproof lens cover for square pilot lights	APW00LN
		Waterproof lens cover for square illuminated buttons	APW00L
		Clear boot for round flush units	OC-31
		Clear boot for round extended units	OC-32
		In place of asterisk, specify Rubber Boot color: B (black), G (green), R (red), Y (yellow)	OCW-11
Anti-Rotation Ring 	Ring to prevents operator base from rotating in the mounting hole	Used when nameplate is not used	OGL-31
Mounting Hole Plug 	Ø 7/8" (22mm) plug used for plugging unused mounting holes in panel		OB-31
Replacement Keys 	Pair of keys (#0)		TW-SK

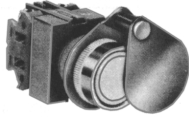

 For information on replacement engraving inserts, see page A-161.

Accessories con't

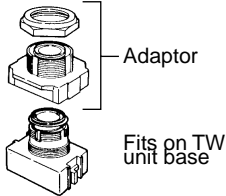
Part Numbers: TW Series Accessories

Appearance	Description/Usage	Part Number
Metal Button Guard 	Used on flush buttons to prevent inadvertent actuation	OLW-C
Terminal Tab Adaptor 	Quick- connect terminals #250 (17/64" x 3/64") single tab #110 (1/8" x 3/64") double tab #187 (3/16" x 1/32") single tab	TW-FA1 TW-FA2 TW-FA3
Lock-out Adaptor 	Used to provide lock-out protection for pushbuttons and knob selector switches: • Up to Ø 1-37/64" (40mm) mushroom (Padlock not included.)	HW9Z-KL1
TW to TWTD Adaptor 	Used to mount TW series control unit (except square units) Ø 7/8" (22mm) into a Ø 1-13/64" (30mm) panel cut-out. Includes 2 pieces shown on the right	TWN-A1R8

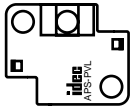
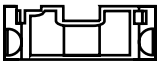
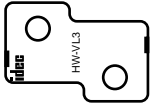
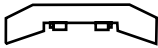
Part Numbers: Fingersafe Covers for TW Series

Appearance	Description	Used with	Part Number
	Fingersafe terminal cover, adds 6mm to overall depth	APW and UPQW full voltage pilot lights	APS-PVL
	Fingersafe terminal cover, adds 3.5mm to overall depth. One required for each contact, only for rear-most terminals	Non-illuminated pushbuttons and selectors	HW-VL2
	Fingersafe terminal cover, adds 3mm to overall depth	APW and UPQW transformer pilot lights, and illuminated pushbuttons and illuminated selectors	HW-VL3
	Fingersafe terminal cover for contacts.	Full voltage illuminated pushbuttons and selectors	HW-VL4
	Fingersafe terminal cover for full voltage adaptor, adds 3 mm to depth	Full voltage illuminated pushbuttons and selectors	HW-VL5
	Fingersafe terminal cover for half size transformer adaptor, adds 3 mm to depth	Illuminated pushbuttons and selectors	HW-VL6

Dimensions — TW Series

Pushbuttons

A

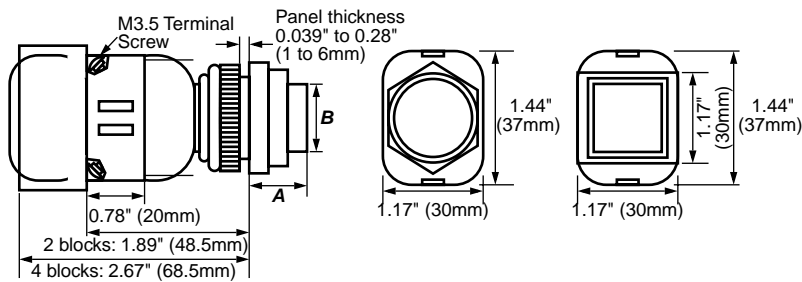

Pushbuttons	Dimension A	Dimension B
Flush	0.507" (13mm)	Ø 0.936" (Ø 24mm) □0.936" (□24mm)
Extended	0.741" (19mm)	Ø 0.936" (Ø 24mm) □0.936" (□24mm)
Mushroom Ø 1.13" (29mm) Ø 1.56" (40mm)	0.858" (22mm) 0.858" (22mm)	Ø 1.13" (29mm) Ø 1.56" (40mm)
Mushroom, Pushlock Key Reset	*0.936" (24mm)	Ø 1.56" (Ø 40mm)
Mushroom, Pushlock Turn-Reset	*0.936" (24mm)	Ø 1.56" (Ø 40mm)
Mushroom/ Push-Pull	† 0.975" (25mm)	Ø 1.56" (Ø 40mm)
Key ON/OFF	*0.936" (24mm)	Ø 0.936" (Ø 24mm)



- * Dimension when operator is in reset position.
- † Dimension when operator is in pull position.

Illuminated Pushbuttons

Illuminated Pushbutton with Full-Size Transformer

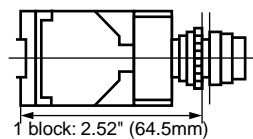

with Half-Size Transformer

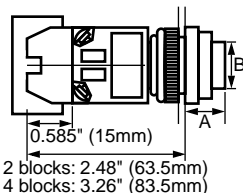
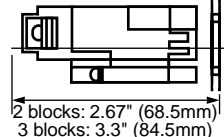

Illuminated Pushbuttons	Dimension A	Dimension B
Extended (Same for Square) w/Full Shroud	0.741" (19mm) 0.761" (19.5mm)	Ø 0.936" (Ø 24mm) □0.975" (□25mm)
Ø 1.13" (29mm) Mushroom Ø 1.56" (40mm) Mushroom, Pushlock Turn Reset, Push-Pull	0.858" (22mm) 0.858" (22mm) *0.936" (24mm) † 0.975" (25mm)	Ø 1.13" (29mm) Ø 1.56" (40mm) Ø 1.56" (40mm) Ø 1.56" (40mm)



- * Dimension when operator is in reset position.
- † Dimension when operator is in pull position.

Dimensions con't

Pilot Light

Pilot Light

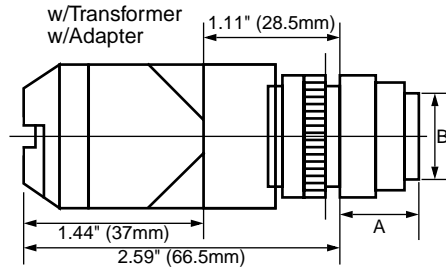

Pilot Lights	Dimension A	Dimension B
Dome	0.975" (25mm)	Ø 0.936" (Ø 24mm)
Flush	0.624" (16mm)	Ø 0.936" (Ø 24mm)
Square Flush	0.624" (16mm)	□0.936" (□24mm)

Selector Switches

Selector Switches

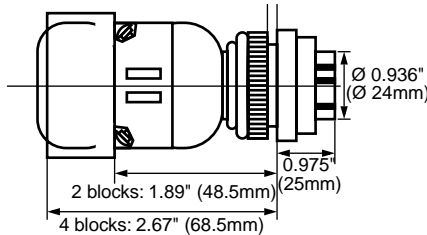

Knob

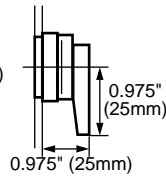

Lever

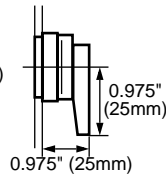

Key

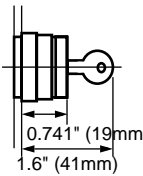

Illuminated Selector Switches

Illuminated Selector Switches Full Voltage

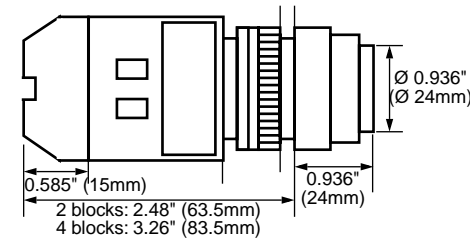

Knob with Full-Size Transformer with AC Adapter

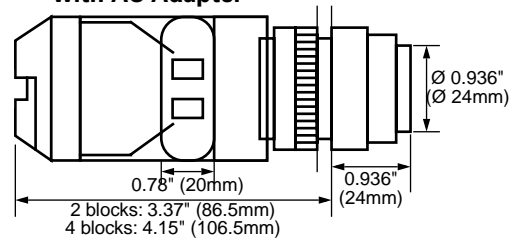

Panel Cut-Out

Diagram	Part	Dimensions			
		A	B	C	D
	Pushbuttons	Ø 0.137" (3.5mm)	1.95" (50mm); 1.76" (45mm) minimum	Ø 0.878" (22.3mm)	1.17" (30mm) Std. Octagonal > 1.56" (40mm) Large Mushroom
	Pilot Light				
	Illuminated Pushbutton				
	Selector Switches				
	Illuminated Selector Switches				1.17" (30mm) *See note.



- The Ø 0.137" (Ø 3.5mm) recess is necessary when either the nameplate or anti-rotation ring is used.
- * >1.404" (36mm) for 2- or 3-position.
>1.95" (50mm) for 4- or 5-position.

Dimensions con't

Accessory Dimensions

OGL-31
Anti-Rotation Ring

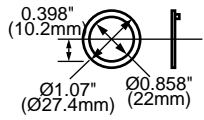

OLW-C
Metal Button Guard

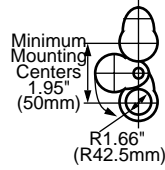

OCW-11
Pushbutton Rubber Boot

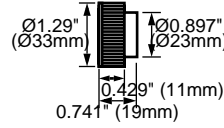

OB-31
Mounting Hole Rubber Plug

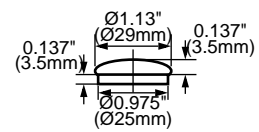

HW9Z-KL1 (TW)
Lock-out Adaptor

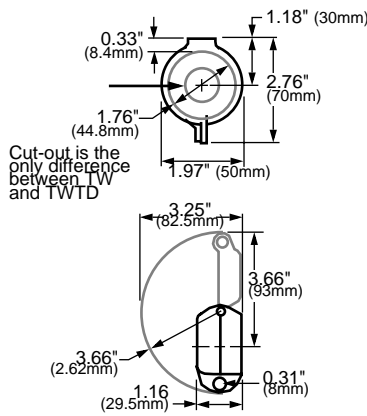

AW-RP1
Round Plastic Bezel

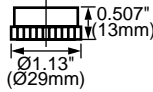

AW-FP1
Round Plastic w/Full Shroud

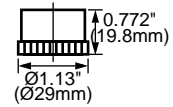

AW-QF1B
Square Full Shroud

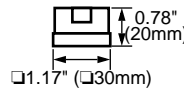

AW-H1
Square Bezel w/ Round Hole

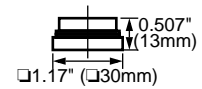

Finger-Safe Cover Dimensions

HW-VL6

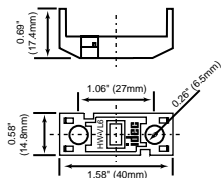

HW-VL5

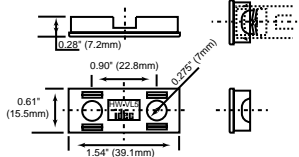

HW-VL4

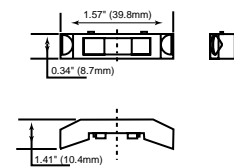

HW-VL3

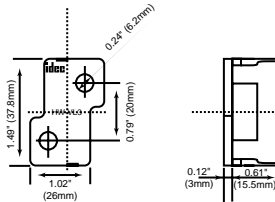

HW-VL2

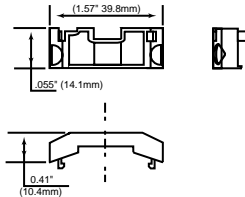

APS-PVL

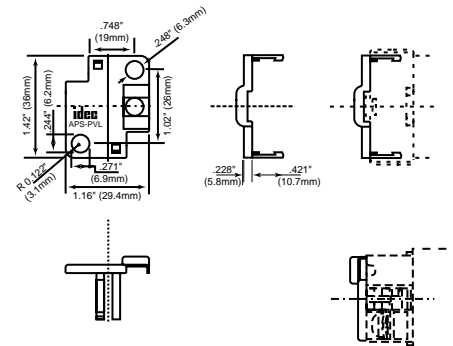

Component Construction — TW Series

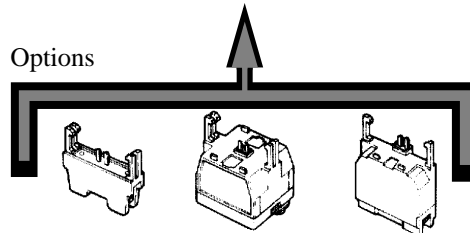
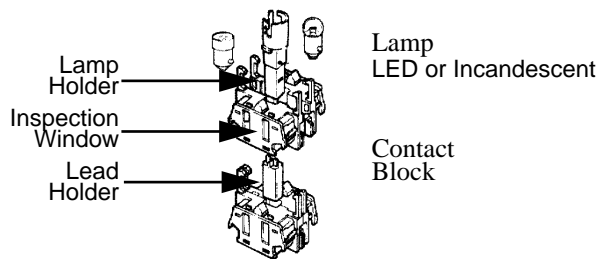
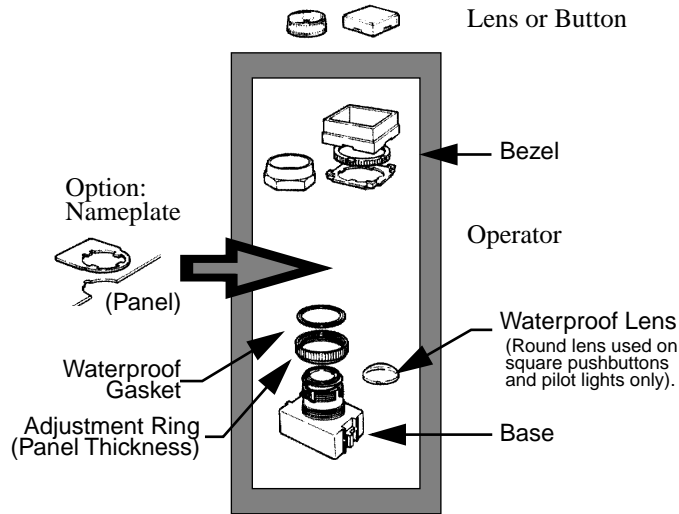

Full Voltage Adaptor:
Used with full voltage LED or incandescent.

Full-Size Transformer:
Used with incandescent/LED – even number of contact blocks.

Half-Size Transformer:
Used with incandescent – odd number of contact blocks.

Instructions — TW Serie

Instructions for Switches and Pilot Devices

TW Series: Adjustment for Panel Thickness

The panel thickness ring provides adjustment from 0.04" to 0.24" (1 to 6mm) in 0.004" (0.1mm) increments. Rotate the ring until the markings around the periphery are aligned for the desired thickness, as shown below.

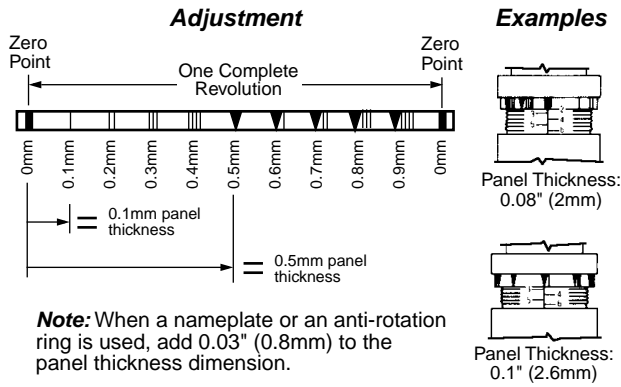

An adjustment for panel thicknesses shown below can be made quickly by using the contact block remover tool.

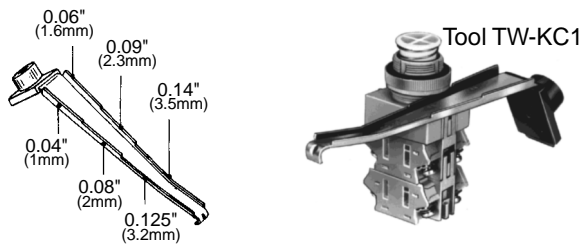

Instructions con't

Pilot Lights and Pushbuttons

IMPORTANT: Install the body of the TW control unit with the panel thickness scale facing up.

Octagonal and Round Bezels

Octagonal and round bezels screw into the operator. Use the locking ring wrench (optional) for secure tightening and easy removal. Round flush and extended buttons snap onto the operator base. Mushroom buttons screw onto the operator base.

Every round lens can be used with or without legend markings. Engraving can be done on a white translucent plate which is placed in the lens, or clear mylar can be printed and placed in the lens.

Round Marking Unit

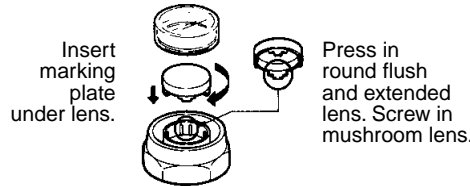

Square Bezels

Square bezels are installed in a 3-step procedure. First install the base plate from the front. Then install the lock nut using the nut locking wrench (optional). Finally, install the square bezel, which snap-fits onto the base plate. Square buttons also snap onto the operator base.

Every square lens can be used with or without legend markings. Engraving can be done on a white translucent plate which is placed in the lens, or clear mylar can be printed and placed in the lens. Square units include a round waterproof lens which screws into the operator. The square outer lens snaps on.

Square Marking Units

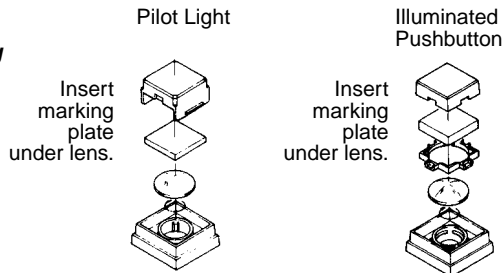

To remove square lens from operator, place a screwdriver under the indentation on the side of the lens. To remove the marking plate, place a screwdriver under the indentation and lift out the plate. The lens retainer can be removed by pressing a 3/16" screwdriver into one of the recesses.



Marking Plate Engraving Area

Shape	Engraving Area	Used With	Part Number
Round	Ø 0.55" (14mm)	Illuminated pushbuttons	ALW2BP
	Ø 0.55" (14mm)	Pilot lights	APW2BP
Mushroom	Ø 0.55" (14mm)	Illuminated mushroom	ALW3BP
Square	□ 0.83" (21mm)	Square pilot lights	APQW1BP
Square	□ 0.83" (21mm)	Square illuminated pushbuttons	ALQW2BP

Instructions con't

Selector Switches

The operator shaft of each unit has a recess to identify in which direction to install the handle. Align the handle with the recess. Press color insert (TW-HC1) into the handle and then press handle into the operator, as shown below.

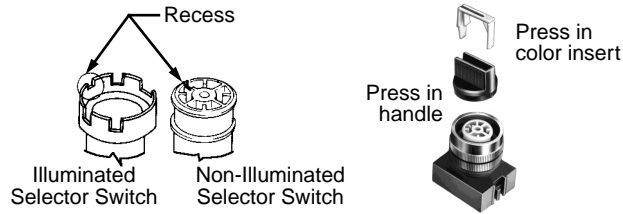

Remove color insert before pulling out the handle.

Standard Operating Positions

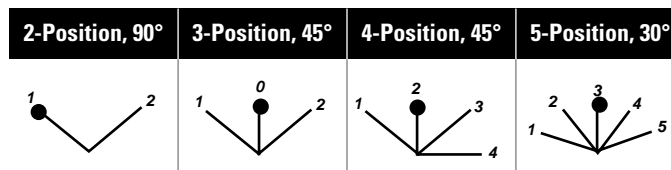

Positions:

Non-illuminated 3-Position Operators

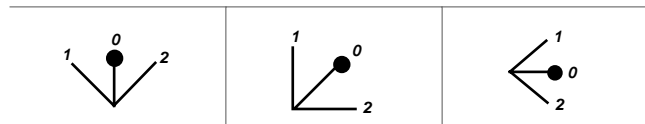

Installation

TW Pilot Lights

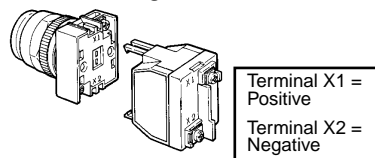

TW Illuminated Pushbuttons, TW Selector Switches (AC Adaptor or Full Voltage)

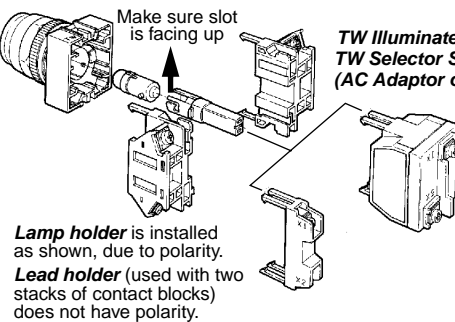

Installation of LED Illuminated Units

AC adaptor units are recommended for use in areas subjected to inductive noise. When using full voltage types, install a protection diode as shown below. Use diode with AC power supply to protect against reverse polarity. Use with DC power supply to protect against surges and noise.

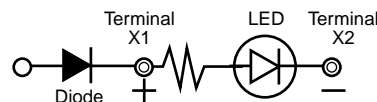

Make sure that LED illuminated units are installed with correct polarity, as indicated at the terminals.