

AA3535QR425Z1S

SERIES



ATTENTION
OBSERVE PRECAUTIONS
FOR HANDLING
ELECTROSTATIC
DISCHARGE
SENSITIVE
DEVICES

Features

- White SMD package, silicone resin.
- Low thermal resistance.
- Compatible with IR-reflow processes.
- ESD protection.
- Package: 2000pcs / reel.
- Moisture sensitivity level : level 2a.
- RoHS compliant

Description

The source color devices are made with InGaN on Al₂O₃ substrate Light Emitting Diode.
Static electricity and surge damage the LEDs.
It is recommended to use a wrist band or anti-electrostatic glove when handling the LEDs.
All devices, equipment and machinery must be electrically grounded.

Applications

- Signal and symbol luminaire for orientation.
- Marker lights (e.g. steps, exit ways, etc).
- Decorative and entertainment lighting.
- Commercial and residential lighting.
- Automotive interior lighting.

Package Dimensions

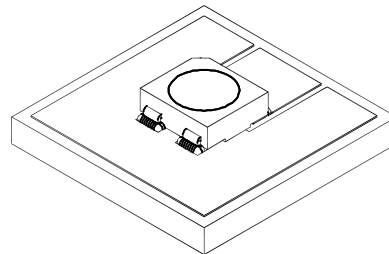
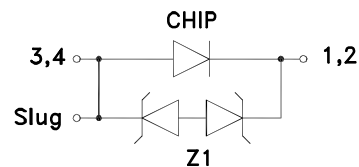
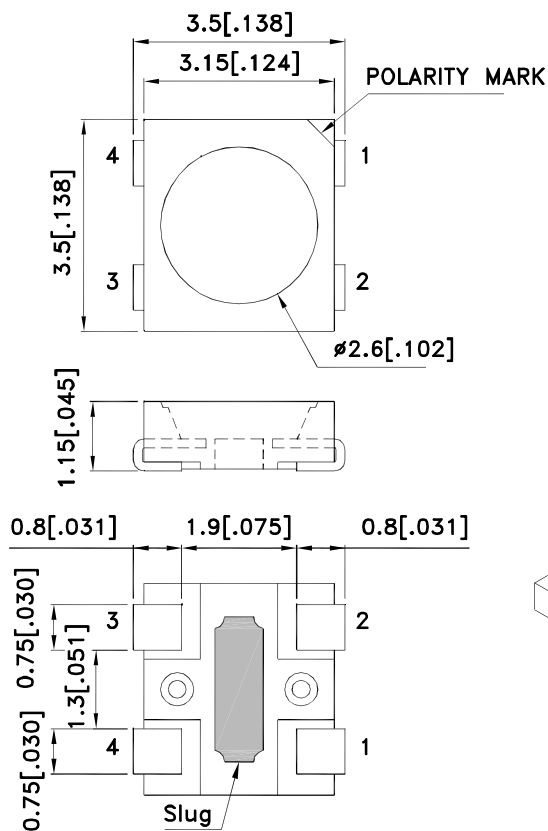

Notes:

1. All dimensions are in millimeters (inches).
2. Tolerance is ± 0.25 (0.01") unless otherwise noted.
3. The specifications, characteristics and technical data described in the datasheet are subject to change without prior notice.
4. The device has a single mounting surface. The device must be mounted according to the specifications.

Handling Precautions

Compare to epoxy encapsulant that is hard and brittle, silicone is softer and flexible. Although its characteristic significantly reduces thermal stress, it is more susceptible to damage by external mechanical force.

As a result, special handling precautions need to be observed during assembly using silicone encapsulated LED products. Failure to comply might lead to damage and premature failure of the LED.

1. Handle the component along the side surfaces by using forceps or appropriate tools.

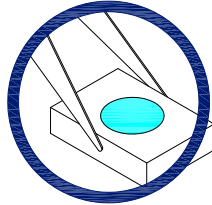

2. Do not directly touch or handle the silicone lens surface. It may damage the internal circuitry.

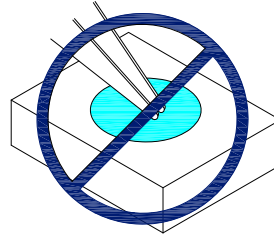
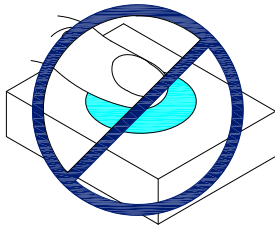

3. Do not stack together assembled PCBs containing exposed LEDs. Impact may scratch the silicone lens or damage the internal circuitry.

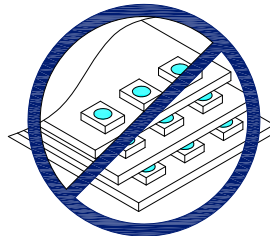

4. The outer diameter of the SMD pickup nozzle should not exceed the size of the LED to prevent air leaks. The inner diameter of the nozzle should be as large as possible.
5. A pliable material is suggested for the nozzle tip to avoid scratching or damaging the LED surface during pickup.
6. The dimensions of the component must be accurately programmed in the pick-and-place machine to insure precise pickup and avoid damage during production.

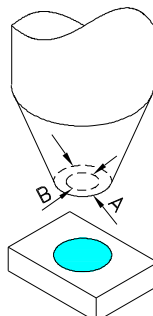

Selection Guide

Erp	Part No.	Color	CCT Range (K)			Lens Type	Iv (cd) [2] @ 150mA		Φv (lm) [2] @ 150mA		Viewing Angle [1]
			Min.	Typ.	Max.		Min.	Typ.	Min.	Typ.	2 θ 1/2
1201005741	AA3535QR425Z1S-C1	Cool White	5310	6000	7040	WATER CLEAR	6.7	8.5	24	35	120 °
1201005743	AA3535QR425Z1S-N2	Neutral White	4260	4700	5310	WATER CLEAR	6.7	8.2	24	34	120 °
1201005742	AA3535QR425Z1S-N1	Neutral White	3710	4000	4260	WATER CLEAR	6.7	8.0	24	32	120 °
1201005745	AA3535QR425Z1S-W2	Warm White	2870	3000	3220	WATER CLEAR	6.0	7.5	20	29	120 °
1201005744	AA3535QR425Z1S-W1	Warm White	2580	2700	2870	WATER CLEAR	6.0	7.0	20	26	120 °

Notes:

1. θ1/2 is the angle from optical centerline where the luminous intensity is 1/2 of the optical peak value.
2. Luminous intensity/ luminous Flux: +/-15%.

Absolute Maximum Ratings at TA=25°C

Parameter	Symbol	Value	Unit
Power Dissipation	P _D	600	mW
Junction Temperature [1]	T _J	130	°C
Operating Temperature	T _{op}	-40 To +100	°C
Storage Temperature	T _{stg}	-40 To +110	°C
DC Forward Current [1]	I _F	150	mA
Peak Forward Current [2]	I _{FM}	300	mA
Reverse Voltage	V _R	5	V
Thermal Resistance [1] (Junction/ambient)	R _{th j-a}	180	°C/W
Thermal Resistance [1] (Junction/solder point)	R _{th j-s}	60	°C/W
Electrostatic Discharge Threshold (HBM)		8000	V

Notes:

1. Results from mounting on PC board FR4 (pad size ≥ 70mm²), mounted on pc board-metal core PCB is recommend for lowest thermal Resistance.
2. 1/10 Duty Cycle, 0.1ms Pulse Width.

Electrical / Optical Characteristics at TA=25°C

Parameter	Symbol	Value	Unit
Forward Voltage I _F = 150mA [Min.]	V _F [1]	2.7	V
Forward Voltage I _F = 150mA [Typ.]		3.5	
Forward Voltage I _F = 150mA [Max.]		4.0	
Reverse Current (V _R = 5V) [Max.]	I _R	10	uA
Temperature coefficient of V _F I _F =150mA, -10 ° C ≤ T ≤ 100 ° C [Typ.]	TC _V	-3.1	mV/° C
Temperature coefficient of X I _F =150mA, -10 ° C ≤ T ≤ 100 ° C [Typ.]	TC _X	-0.15	10 ⁻³ /° C
Temperature coefficient of Y I _F =150mA, -10 ° C ≤ T ≤ 100 ° C [Typ.]	TC _Y	-0.13	10 ⁻³ /° C

Notes:

1. Measurement tolerance of the chromaticity coordinates is ±0.01.
2. Forward Voltage: +/-0.1V.

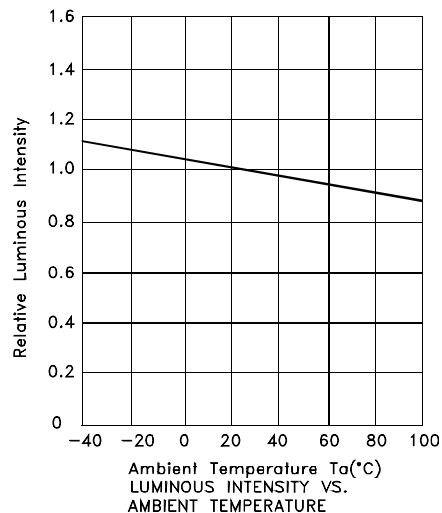
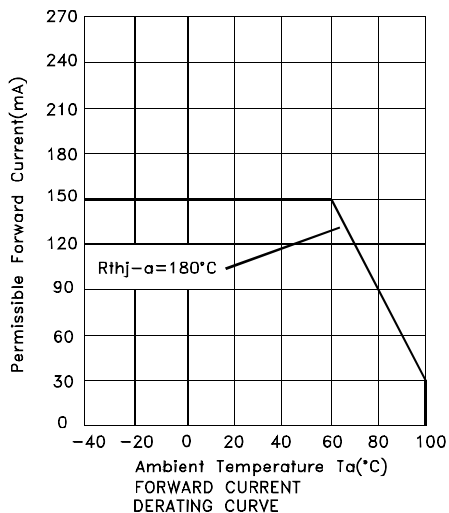
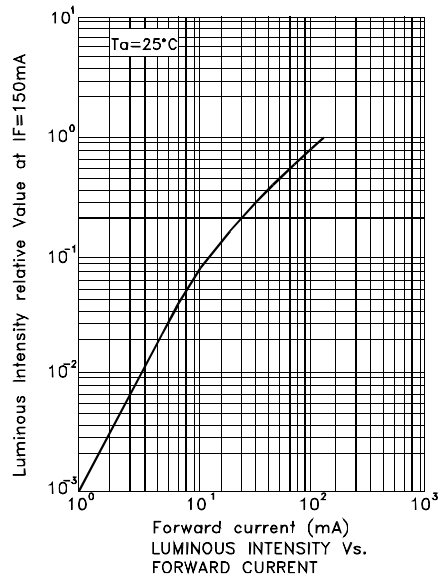
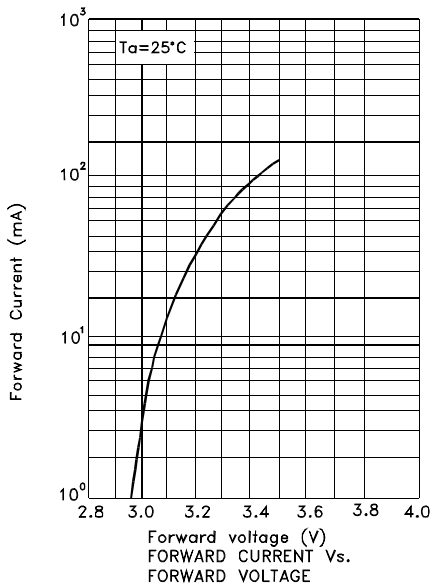
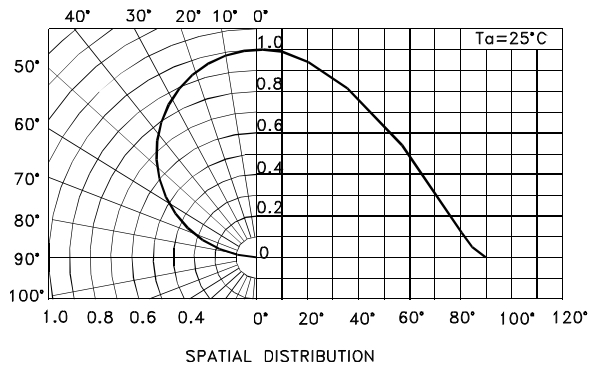

CCT 2500-7000 K Bin Code

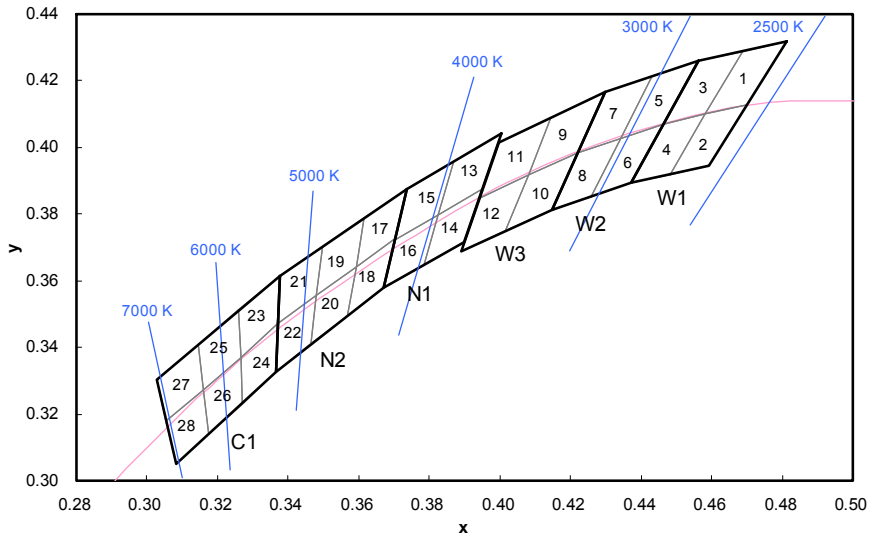

Color	Group	Chromaticity Regions	CCT (K)		
			Min.	Typ.	Max.
Warm White	W1	1, 2, 3, 4	2580	2700	2870
	W2	5, 6, 7, 8	2870	3000	3220
	W3	9, 10, 11, 12	3220	3500	3710
Neutral White	N1	13, 14, 15, 16	3710	4000	4260
	N2	17, 18, 19, 20, 21, 22	4260	4700	5310
Cool White	C1	23, 24, 25, 26, 27, 28	5310	6000	7040

Notes:
 Shipment may contain more than one chromaticity regions. Orders for single chromaticity region are generally not accepted.
 Measurement tolerance of the chromaticity coordinates is ± 0.01 .

	x	y		x	y		x	y		x	y
1	0.4582	0.4099	8	0.4147	0.3814	15	0.3702	0.3722	22	0.3481	0.3557
	0.4687	0.4289		0.4221	0.3984		0.3736	0.3874		0.3370	0.3472
	0.4813	0.4319		0.4342	0.4028		0.3869	0.3958		0.3364	0.3328
	0.4700	0.4126		0.4259	0.3853		0.3825	0.3798		0.3466	0.3411
2	0.4483	0.3919	9	0.4080	0.3916	16	0.3670	0.3578	23	0.3376	0.3616
	0.4582	0.4099		0.4146	0.4089		0.3702	0.3722		0.3260	0.3512
	0.4700	0.4126		0.4299	0.4165		0.3825	0.3798		0.3265	0.3371
	0.4593	0.3944		0.4221	0.3984		0.3783	0.3646		0.3370	0.3472
3	0.4465	0.4071	10	0.4017	0.3751	17	0.3736	0.3874	24	0.3370	0.3472
	0.4562	0.4260		0.4080	0.3916		0.3616	0.3788		0.3265	0.3371
	0.4687	0.4289		0.4221	0.3984		0.3592	0.3641		0.3270	0.3230
	0.4582	0.4099		0.4147	0.3814		0.3703	0.3726		0.3364	0.3328
4	0.4373	0.3893	11	0.3941	0.3848	18	0.3703	0.3726	25	0.3260	0.3512
	0.4465	0.4071		0.3996	0.4015		0.3592	0.3641		0.3144	0.3408
	0.4582	0.4099		0.4146	0.4089		0.3568	0.3495		0.3160	0.3274
	0.4483	0.3919		0.4080	0.3916		0.3670	0.3578		0.3265	0.3371
5	0.4342	0.4028	12	0.3889	0.3690	19	0.3616	0.3788	26	0.3265	0.3371
	0.4430	0.4212		0.3941	0.3848		0.3496	0.3702		0.3160	0.3274
	0.4562	0.4260		0.4080	0.3916		0.3481	0.3557		0.3175	0.3139
	0.4465	0.4071		0.4017	0.3751		0.3592	0.3641		0.3270	0.3230
6	0.4259	0.3853	13	0.3825	0.3798	20	0.3592	0.3641	27	0.3144	0.3408
	0.4342	0.4028		0.3869	0.3958		0.3481	0.3557		0.3028	0.3304
	0.4465	0.4071		0.4006	0.4044		0.3466	0.3411		0.3055	0.3177
	0.4373	0.3893		0.3950	0.3875		0.3568	0.3495		0.3160	0.3274
7	0.4221	0.3984	14	0.3783	0.3646	21	0.3496	0.3702	28	0.3160	0.3274
	0.4299	0.4165		0.3825	0.3798		0.3376	0.3616		0.3055	0.3177
	0.4430	0.4212		0.3950	0.3875		0.3370	0.3472		0.3081	0.3049
	0.4342	0.4028		0.3898	0.3716		0.3481	0.3557		0.3175	0.3139

Reflow soldering is recommended and the soldering profile is shown below.
Other soldering methods are not recommended as they might cause damage to the product.

Reflow Soldering Profile For Lead-free SMT Process.

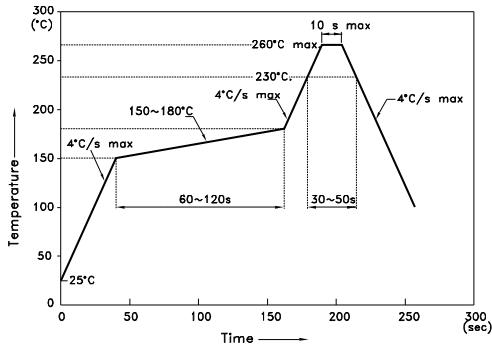

- NOTES:
1. We recommend the reflow temperature 245°C(+/-5°C). The maximum soldering temperature should be limited to 260°C.
 2. Don't cause stress to the epoxy resin while it is exposed to high temperature.
 3. Number of reflow process shall be 2 times or less.

Reel Dimension

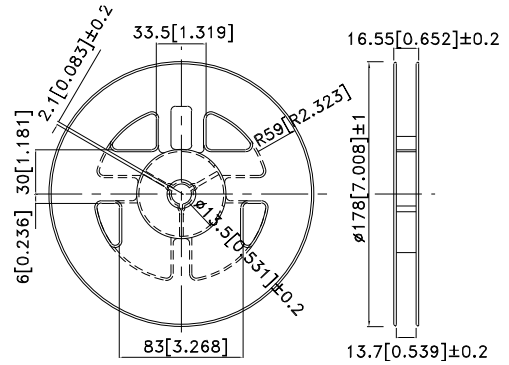

Recommended Soldering Pattern (Units : mm; Tolerance: ±0.1)

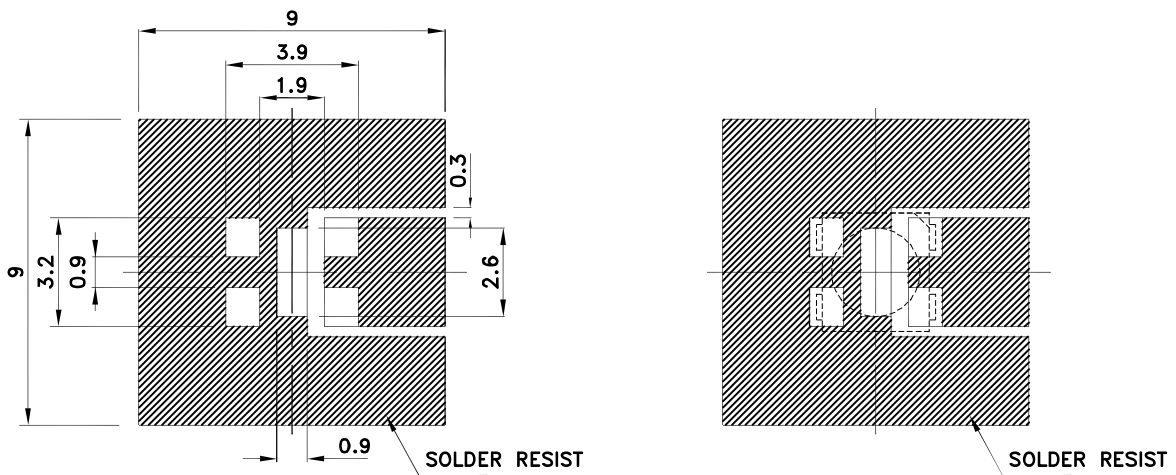

Tape Specifications (Units : mm)

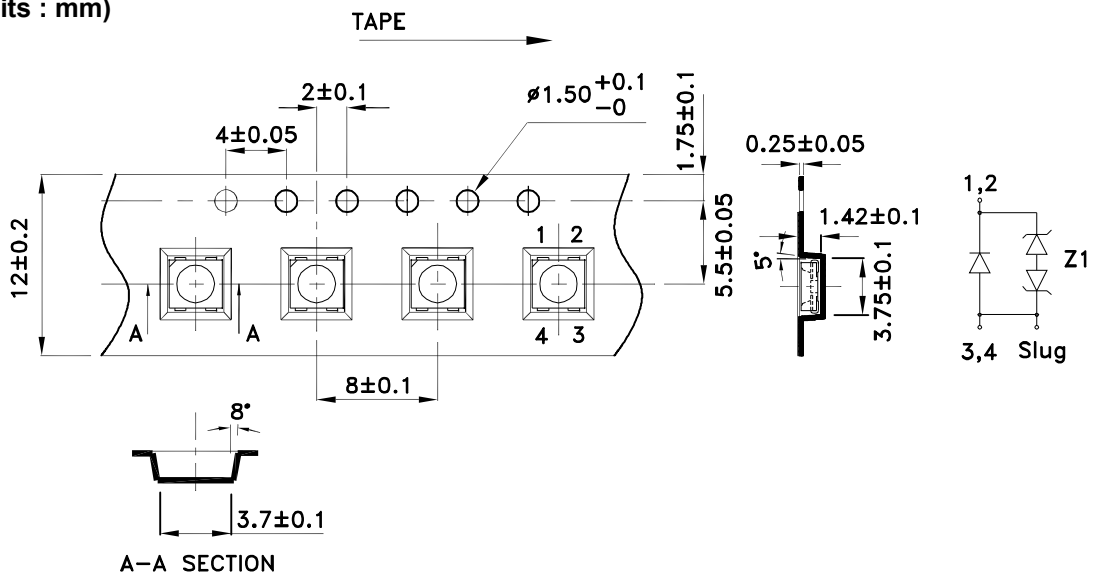



Kingbright

PACKING & LABEL SPECIFICATIONS

AA3535QR425Z1S

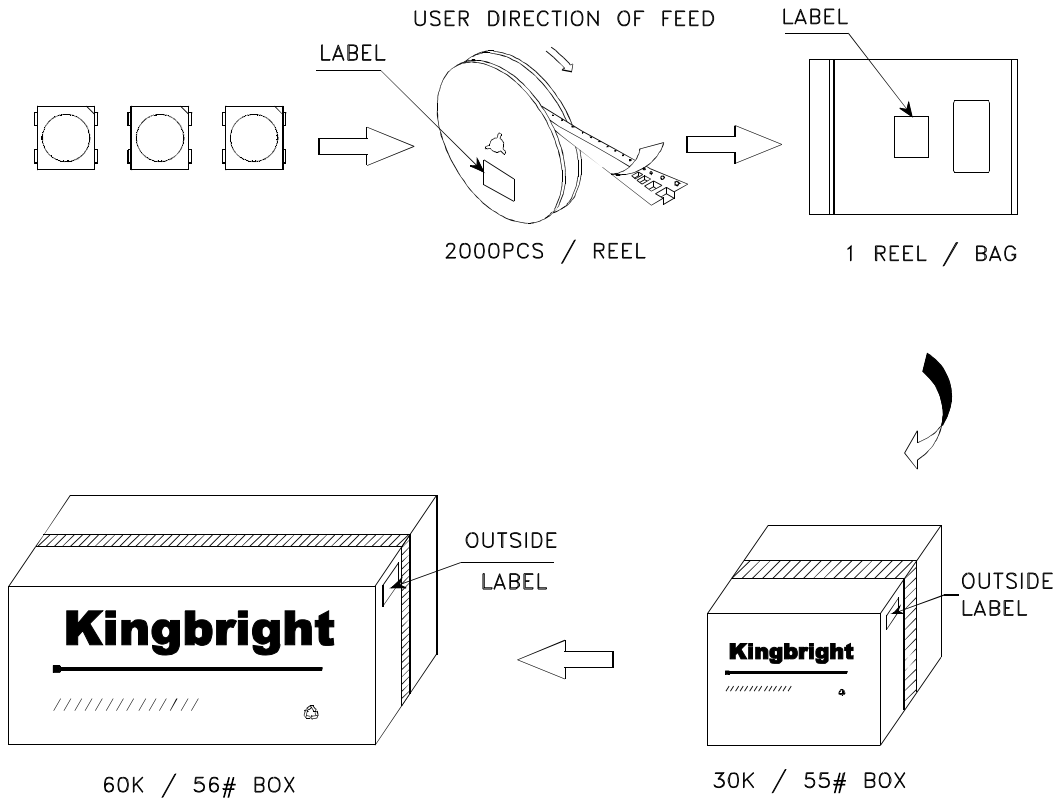
SERIES



<h1>Kingbright</h1>		
P/NO: AA3535xxx		
QTY: 2000 pcs	Q.C.	Q C xx xx xxxx PASSED
S/N: XXXX		
CODE: XXX		
LOT NO:		
 xxxxxxxxxxxxxxxxxxxxxxxxxxxx		
RoHS Compliant		