

PRELIMINARY SPEC

Part Number: AA3528VWC1S

White



ATTENTION
OBSERVE PRECAUTIONS
FOR HANDLING
ELECTROSTATIC
DISCHARGE
SENSITIVE
DEVICES

Features

- Single color.
- Suitable for all SMT assembly and solder process.
- Available on tape and reel.
- Ideal for backlighting.
- Package : 1500pcs / reel.
- Moisture sensitivity level : level 3.
- RoHS compliant.

Description

The source color devices are made with InGaN Light Emitting Diode.

Static electricity and surge damage the LEDs.

It is recommended to use a wrist band or anti-electrostatic glove when handling the LEDs.

All devices, equipment and machinery must be electrically grounded.

Package Dimensions

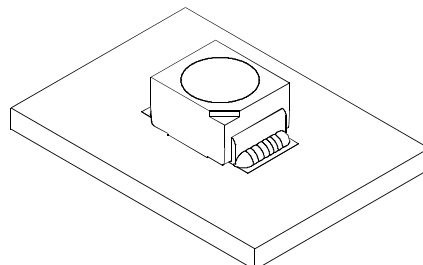
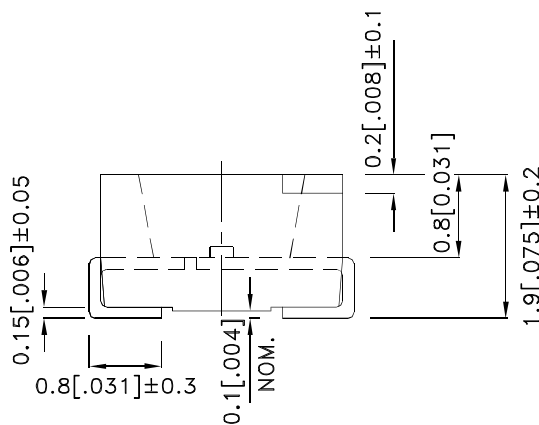
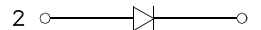
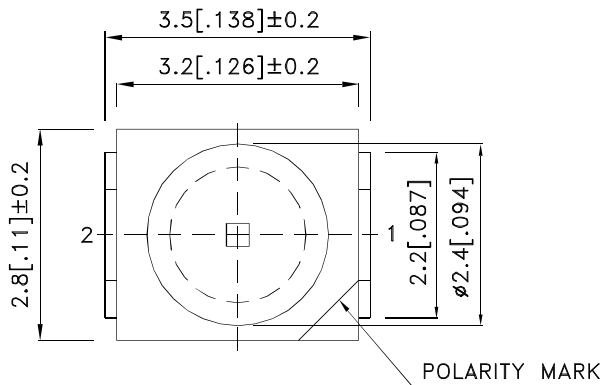

Notes:

1. All dimensions are in millimeters (inches).
2. Tolerance is $\pm 0.25(0.01)$ unless otherwise noted.
3. Specifications are subject to change without notice.
4. The device has a single mounting surface. The device must be mounted according to the specifications.



Handling Precautions

Compare to epoxy encapsulant that is hard and brittle, silicone is softer and flexible. Although its characteristic significantly reduces thermal stress, it is more susceptible to damage by external mechanical force.

As a result, special handling precautions need to be observed during assembly using silicone encapsulated LED products. Failure to comply might leads to damage and premature failure of the LED.

1. Handle the component along the side surfaces by using forceps or appropriate tools.

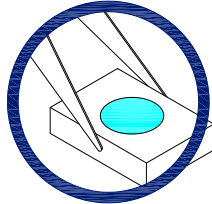

2. Do not directly touch or handle the silicone lens surface. It may damage the internal circuitry.

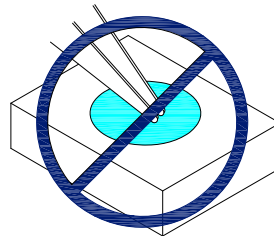
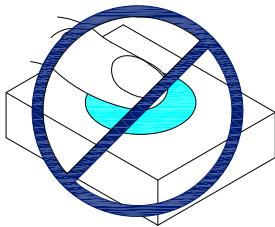

3. Do not stack together assembled PCBs containing exposed LEDs. Impact may scratch the silicone lens or damage the internal circuitry.

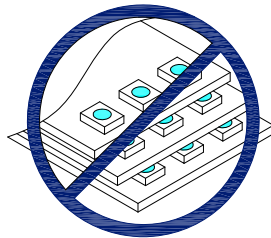

4. The outer diameter of the SMD pickup nozzle should not exceed the size of the LED to prevent air leaks. The inner diameter of the nozzle should be as large as possible.

5. A pliable material is suggested for the nozzle tip to avoid scratching or damaging the LED surface during pickup.

6. The dimensions of the component must be accurately programmed in the pick-and-place machine to insure precise pickup and avoid damage during production.

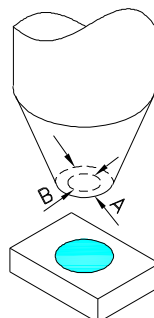

Selection Guide

| Part No. | Dice | Lens Type | Iv (mcd) [2] @ 20mA | | Viewing Angle [1] |
|-------------|---------------|-------------|------------------------|------|----------------------|
| | | | Min. | Typ. | 2θ1/2 |
| AA3528VWC1S | White (InGaN) | WATER CLEAR | 900 | 1500 | 120° |

Notes:

- θ1/2 is the angle from optical centerline where the luminous intensity is 1/2 of the optical peak value.
- Luminous intensity/ luminous Flux: +/-15%.

Electrical / Optical Characteristics at TA=25°C

| Symbol | Parameter | Device | Typ. | Max. | Units | Test Conditions |
|--------------------|--------------------------|--------|------|------|-------|---------------------------|
| V _F [1] | Forward Voltage | White | 3.3 | 4.0 | V | I _F =20mA |
| I _R | Reverse Current | White | | 10 | uA | V _R = 5V |
| x [2] | Chromaticity Coordinates | White | 0.31 | | | |
| y [2] | | | 0.31 | | | |
| C | Capacitance | White | 100 | | pF | V _F =0V;f=1MHz |

Notes:

- Forward Voltage: +/-0.1V.
- Measurement tolerance of the chromaticity coordinates is ±0.01 .

Absolute Maximum Ratings at TA=25°C

| Parameter | White | Units |
|--------------------------|----------------|-------|
| Power dissipation | 120 | mW |
| DC Forward Current | 30 | mA |
| Peak Forward Current [1] | 100 | mA |
| Reverse Voltage | 5 | V |
| Operating Temperature | -40°C To +85°C | |
| Storage Temperature | -40°C To +85°C | |

Note:

- 1/10 Duty Cycle, 0.1ms Pulse Width.

White

AA3528VWC1S

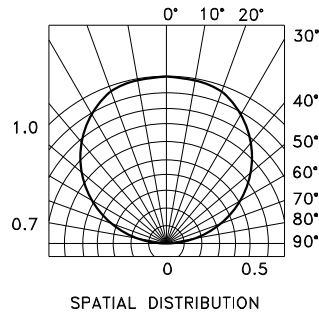
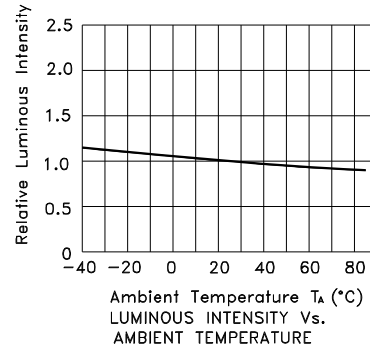
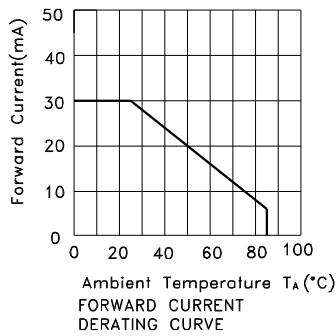
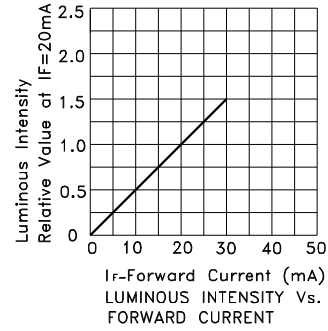
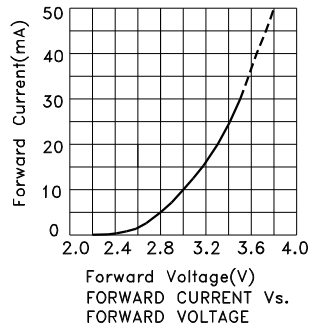

AA3528VWC1S

White CIE

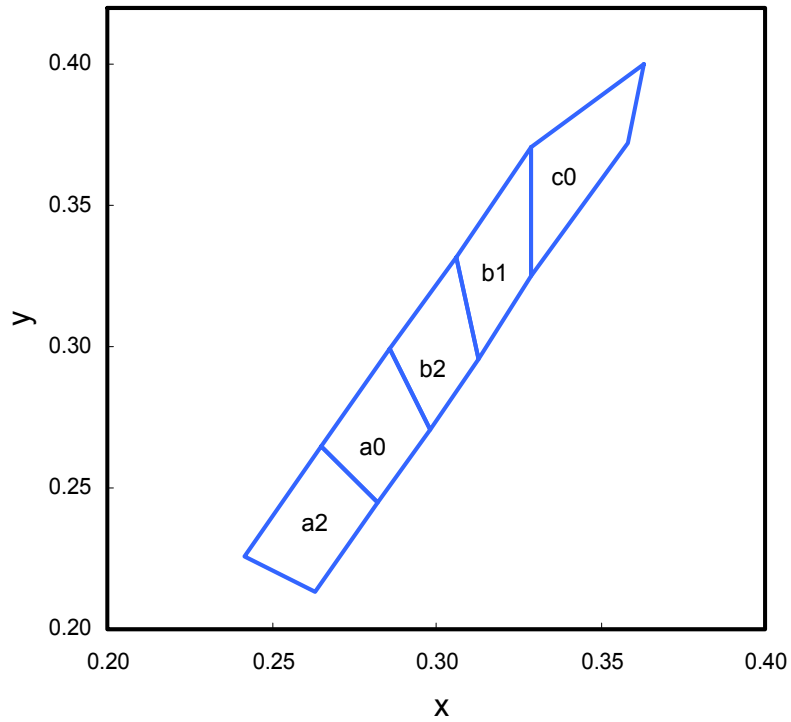

| | x | y | | x | y | | x | y |
|----|-------|-------|----|-------|-------|----|-------|-------|
| a2 | 0.263 | 0.213 | a0 | 0.282 | 0.245 | b2 | 0.298 | 0.271 |
| | 0.282 | 0.245 | | 0.298 | 0.271 | | 0.313 | 0.296 |
| | 0.265 | 0.265 | | 0.286 | 0.299 | | 0.306 | 0.332 |
| | 0.242 | 0.226 | | 0.265 | 0.265 | | 0.286 | 0.299 |
| b1 | 0.313 | 0.296 | c0 | 0.329 | 0.325 | | | |
| | 0.329 | 0.325 | | 0.358 | 0.372 | | | |
| | 0.329 | 0.371 | | 0.363 | 0.400 | | | |
| | 0.306 | 0.332 | | 0.329 | 0.371 | | | |

AA3528VWC1S

Reflow soldering is recommended and the soldering profile is shown below.
Other soldering methods are not recommended as they might cause damage to the product.

Reflow Soldering Profile For Lead-free SMT Process.

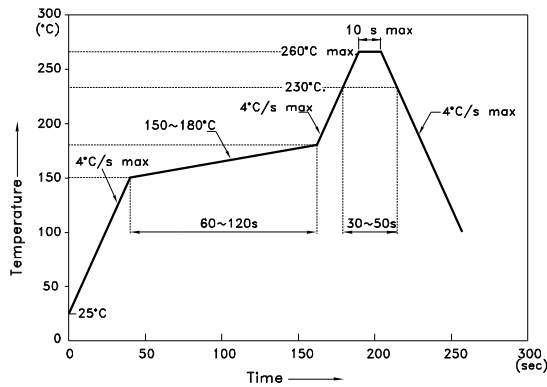

NOTES:

1. We recommend the reflow temperature 245°C(+/-5°C). The maximum soldering temperature should be limited to 260°C.
2. Don't cause stress to the epoxy resin while it is exposed to high temperature.
3. Number of reflow process shall be 2 times or less.

Recommended Soldering Pattern (Units : mm; Tolerance: ± 0.1)

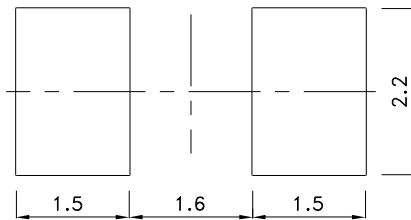

Tape Dimensions (Units : mm)

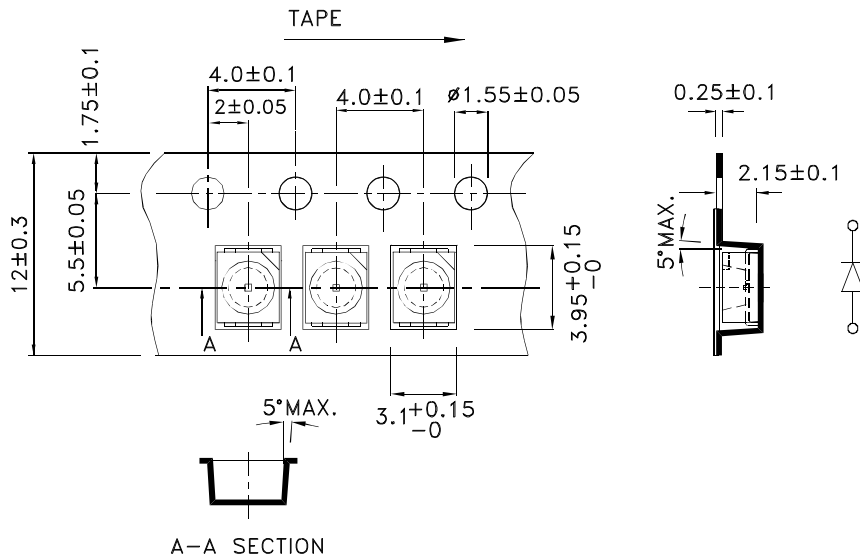

Kingbright

PACKING & LABEL SPECIFICATIONS

AA3528VVC1S

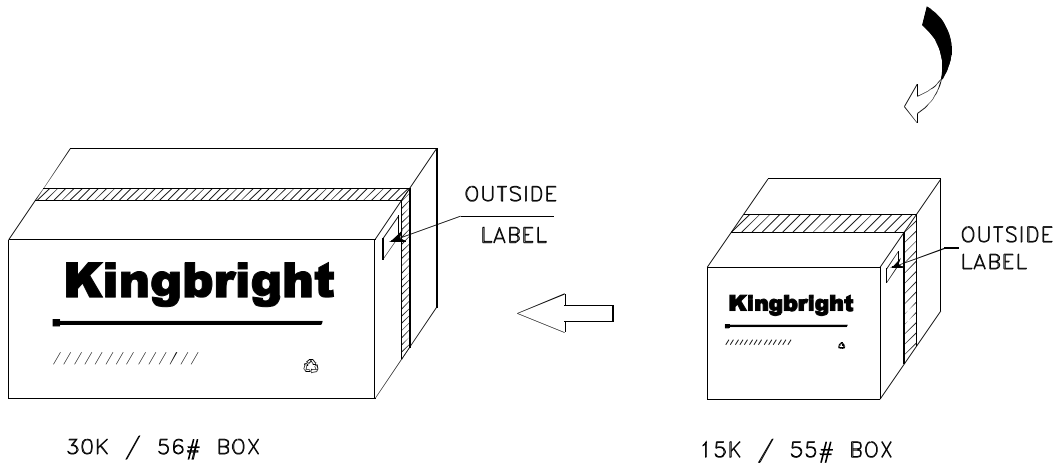
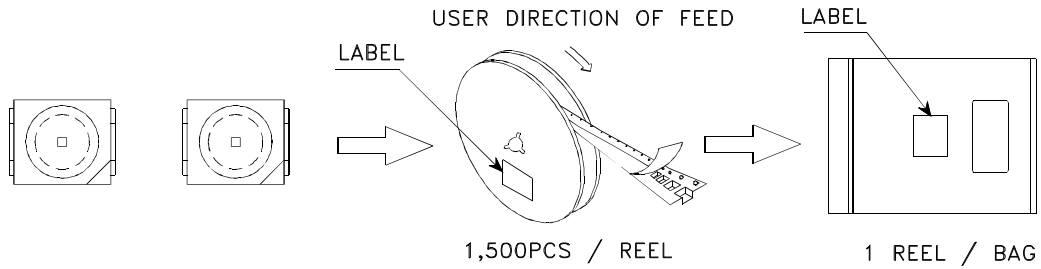

| | |
|--|--|
| <h1>Kingbright</h1> | |
| P/NO: AA3528xxx | |
| QTY: 1,500 pcs | Q.C. Q C XX XX XXXX PASSED |
| S/N: XXXX | |
| CODE: XXX | |
| LOT NO: | |
|  XXXXXXXXXXXXXXXXXXXXXXXXXXXX | |
| RoHS Compliant | |