



**ATTENTION**  
OBSERVE PRECAUTIONS  
FOR HANDLING  
ELECTROSTATIC  
DISCHARGE  
SENSITIVE  
DEVICES

Part Number: AA3528VR41S-W2-AMT

### Features

- Industry standard PLCC-2 package.
- High reliability LED package.
- Wide viewing angle.
- Single color.
- Suitable for all SMT assembly and solder process.
- Available on tape and reel.
- Ideal for backlighting.
- Package : 1500pcs / reel.
- Moisture sensitivity level : level 3.
- RoHS compliant.

### Description

The source color devices are made with InGaN Light Emitting Diode.

Static electricity and surge damage the LEDs.

It is recommended to use a wrist band or anti-electrostatic glove when handling the LEDs.

All devices, equipment and machinery must be electrically grounded.

### Applications

- Traffic signaling.
- Backlighting (illuminated advertising , general lighting).
- Interior and exterior automotive lighting.
- Substitution of micro incandescent lamps.
- Reading lamps.
- Signal and symbol luminaire for orientation.
- Marker lights (e.g. Steps, exit ways, etc).
- Decorative and entertainment lighting.
- Indoor and outdoor commercial and residential architectural lighting.

### Package Dimensions

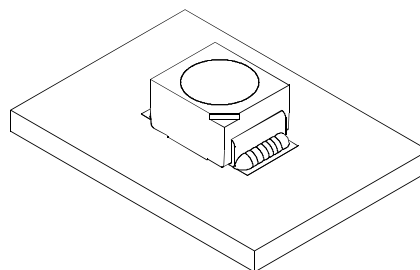
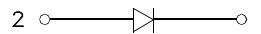
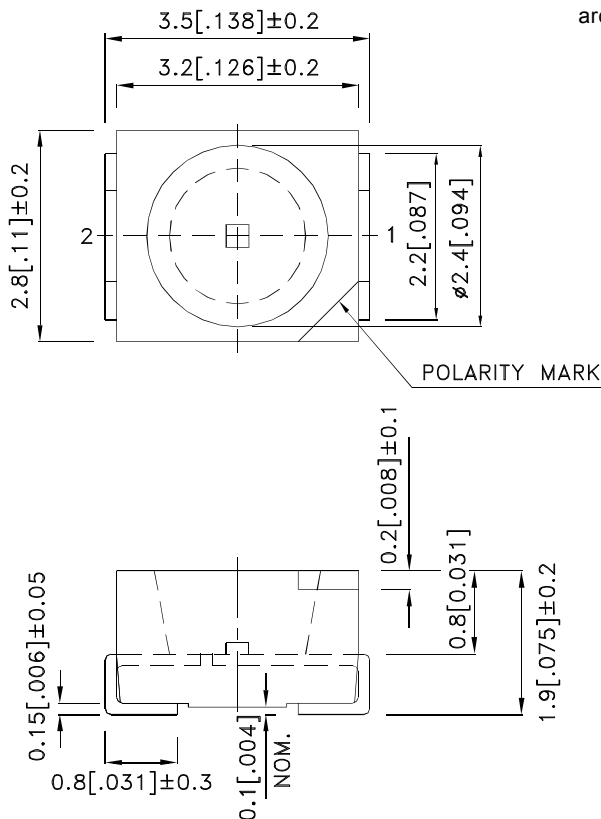

#### Notes:

1. All dimensions are in millimeters (inches).
2. Tolerance is  $\pm 0.25(0.01)$  unless otherwise noted.
3. The specifications, characteristics and technical data described in the datasheet are subject to change without prior notice.
4. The device has a single mounting surface. The device must be mounted according to the specifications.



## Handling Precautions

Compare to epoxy encapsulant that is hard and brittle, silicone is softer and flexible. Although its characteristic significantly reduces thermal stress, it is more susceptible to damage by external mechanical force.

As a result, special handling precautions need to be observed during assembly using silicone encapsulated LED products. Failure to comply might lead to damage and premature failure of the LED.

1. Handle the component along the side surfaces by using forceps or appropriate tools.

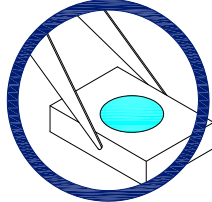

2. Do not directly touch or handle the silicone lens surface. It may damage the internal circuitry.

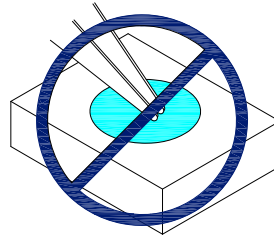
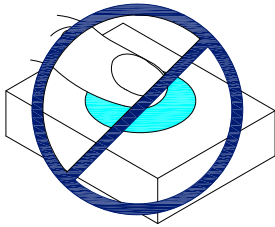

3. Do not stack together assembled PCBs containing exposed LEDs. Impact may scratch the silicone lens or damage the internal circuitry.

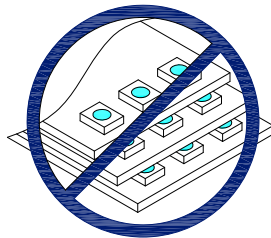

4. The outer diameter of the SMD pickup nozzle should not exceed the size of the LED to prevent air leaks. The inner diameter of the nozzle should be as large as possible.

5. A pliable material is suggested for the nozzle tip to avoid scratching or damaging the LED surface during pickup.

6. The dimensions of the component must be accurately programmed in the pick-and-place machine to insure precise pickup and avoid damage during production.

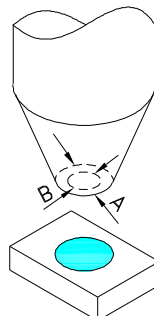

## Selection Guide

Part No.	Dice	CCT Range			Lens Type	Iv (mcd) [2] @ 20mA			Viewing Angle [1]
		Min.	Typ.	Max.		Code.	Min.	Max.	2θ1/2
AA3528VR41S-W2-AMT	Warm White	2870K	3000K	3220K	Water Clear	U	1000	1300	120°
						V	1300	1600	
						W	1600	1900	

Notes:

- θ1/2 is the angle from optical centerline where the luminous intensity is 1/2 of the optical peak value.
- Luminous intensity/ luminous Flux: +/-15%.

## Absolute Maximum Ratings at Ta=25°C

Parameter	Symbol	Value	Unit
Power dissipation	P <sub>D</sub>	120	mW
Reverse Voltage	V <sub>R</sub>	5	V
Junction temperature	T <sub>J</sub>	110	°C
Operating Temperature	T <sub>op</sub>	-40 To +100	°C
Storage Temperature	T <sub>stg</sub>	-40 To +110	°C
DC Forward Current[1]	I <sub>F</sub>	30	mA
Peak Forward Current [2]	I <sub>FM</sub>	100	mA
Electrostatic Discharge Threshold (HBM)		250	V
Thermal Resistance (Junction/ambient) [1]	R <sub>th(j-a)</sub>	300	°C/W

Notes:

- R<sub>th(j-a)</sub> Results from mounting on PC board FR4 (pad size≥16 mm<sup>2</sup> per pad),
- 1/10 Duty Cycle, 0.1ms Pulse Width.

## Electrical / Optical Characteristics at Ta=25°C

Parameter	Symbol	Value	Unit
Forward Voltage I <sub>F</sub> =20mA [Min.]	V <sub>F</sub> [1]	-	V
Forward Voltage I <sub>F</sub> =20mA [Typ.]		3.3	
Forward Voltage I <sub>F</sub> =20mA [Max.]		4.0	
Reverse Current (V <sub>R</sub> = 5V) [Max.]	I <sub>R</sub>	50	uA
Temperature coefficient of V <sub>F</sub> I <sub>F</sub> =20mA, -10 ° C ≤ T ≤ 100 ° C [Typ.]	TC <sub>V</sub>	-2.2	mV/° C
Temperature coefficient of X I <sub>F</sub> =20mA, -10 ° C ≤ T ≤ 100 ° C [Typ.]	TC <sub>X</sub>	-0.1	10 <sup>-3</sup> /° C
Temperature coefficient of Y I <sub>F</sub> =20mA, -10 ° C ≤ T ≤ 100 ° C [Typ.]	TC <sub>Y</sub>	-0.2	10 <sup>-3</sup> /° C

Note:

- Forward Voltage: +/-0.1V.

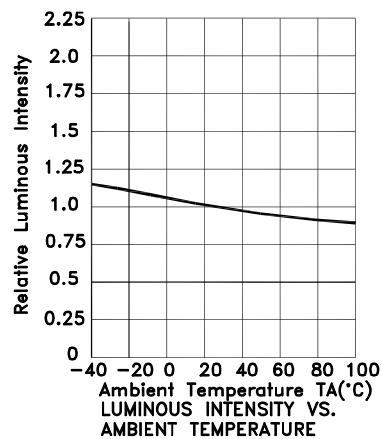
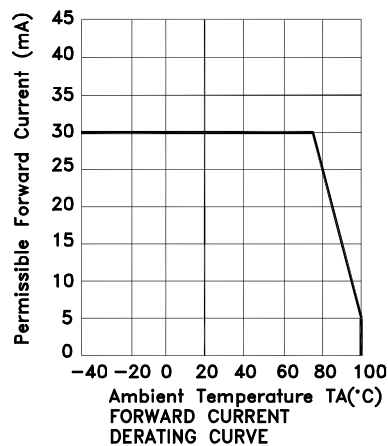
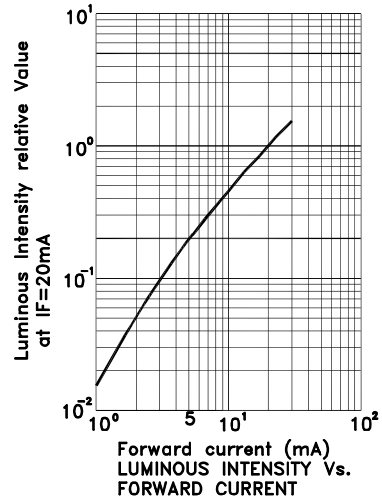
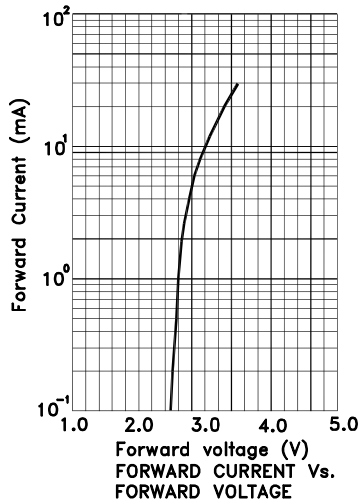
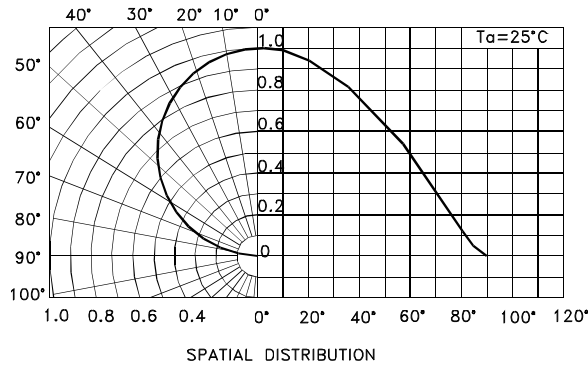

## CCT 2500-7000 K Bin Code

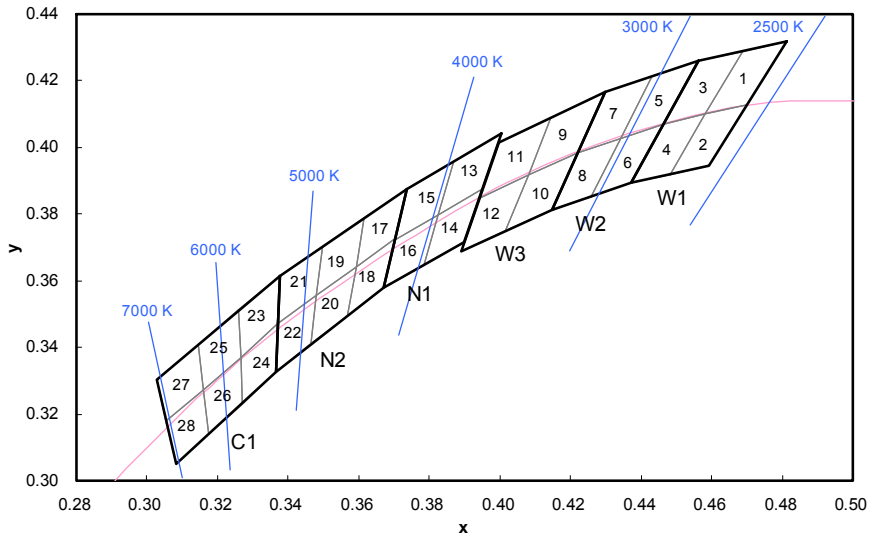

Color	Group	Chromaticity Regions	CCT (K)		
			Min.	Typ.	Max.
Warm White	W1	1, 2, 3, 4	2580	2700	2870
	W2	5, 6, 7, 8	2870	3000	3220
	W3	9, 10, 11, 12	3220	3500	3710
Neutral White	N1	13, 14, 15, 16	3710	4000	4260
	N2	17, 18, 19, 20, 21, 22	4260	4700	5310
Cool White	C1	23, 24, 25, 26, 27, 28	5310	6000	7040

Notes:  
 Shipment may contain more than one chromaticity regions. Orders for single chromaticity region are generally not accepted.  
 Measurement tolerance of the chromaticity coordinates is  $\pm 0.01$ .

	x	y		x	y		x	y		x	y
1	0.4582	0.4099	8	0.4147	0.3814	15	0.3702	0.3722	22	0.3481	0.3557
	0.4687	0.4289		0.4221	0.3984		0.3736	0.3874		0.3370	0.3472
	0.4813	0.4319		0.4342	0.4028		0.3869	0.3958		0.3364	0.3328
	0.4700	0.4126		0.4259	0.3853		0.3825	0.3798		0.3466	0.3411
2	0.4483	0.3919	9	0.4080	0.3916	16	0.3670	0.3578	23	0.3376	0.3616
	0.4582	0.4099		0.4146	0.4089		0.3702	0.3722		0.3260	0.3512
	0.4700	0.4126		0.4299	0.4165		0.3825	0.3798		0.3265	0.3371
3	0.4593	0.3944	10	0.4221	0.3984	17	0.3783	0.3646	24	0.3370	0.3472
	0.4465	0.4071		0.4017	0.3751		0.3736	0.3874		0.3265	0.3371
	0.4562	0.4260		0.4080	0.3916		0.3616	0.3788		0.3270	0.3230
	0.4687	0.4289		0.4221	0.3984		0.3592	0.3641		0.3364	0.3328
4	0.4582	0.4099	11	0.4147	0.3814	18	0.3703	0.3726	25	0.3260	0.3512
	0.4483	0.3919		0.3941	0.3848		0.3703	0.3726		0.3144	0.3408
	0.4465	0.4071		0.3996	0.4015		0.3592	0.3641		0.3160	0.3274
	0.4582	0.4099		0.4146	0.4089		0.3568	0.3495		0.3265	0.3371
5	0.4483	0.3919	12	0.4080	0.3916	19	0.3670	0.3578	26	0.3265	0.3371
	0.4342	0.4028		0.3889	0.3690		0.3616	0.3788		0.3160	0.3274
	0.4430	0.4212		0.3941	0.3848		0.3496	0.3702		0.3175	0.3139
	0.4562	0.4260		0.4080	0.3916		0.3481	0.3557		0.3270	0.3230
6	0.4465	0.4071	13	0.4017	0.3751	20	0.3592	0.3641	27	0.3144	0.3408
	0.4259	0.3853		0.3825	0.3798		0.3481	0.3557		0.3028	0.3304
	0.4342	0.4028		0.3869	0.3958		0.3466	0.3411		0.3055	0.3177
	0.4465	0.4071		0.4006	0.4044		0.3466	0.3411		0.3160	0.3274
7	0.4373	0.3893	14	0.3950	0.3875	21	0.3568	0.3495	28	0.3160	0.3274
	0.4373	0.3893		0.3783	0.3646		0.3496	0.3702		0.3055	0.3177
	0.4221	0.3984		0.3825	0.3798		0.3376	0.3616		0.3081	0.3049
	0.4299	0.4165		0.3825	0.3798		0.3370	0.3472		0.3175	0.3139
7	0.4430	0.4212	14	0.3950	0.3875	21	0.3370	0.3472	28	0.3175	0.3139
	0.4342	0.4028		0.3898	0.3716		0.3481	0.3557			

## AA3528VR41S-W2-AMT

Reflow soldering is recommended and the soldering profile is shown below.  
Other soldering methods are not recommended as they might cause damage to the product.

Reflow Soldering Profile For Lead-free SMT Process.

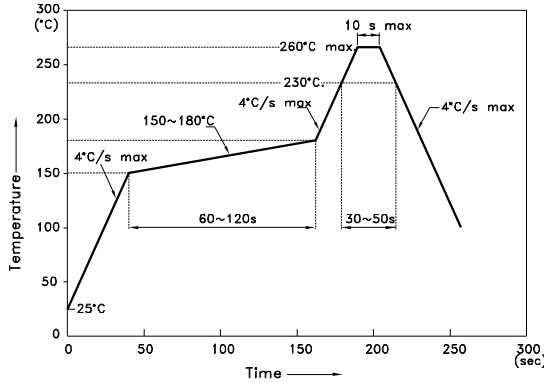

NOTES:

1. We recommend the reflow temperature 245°C(+/-5°C). The maximum soldering temperature should be limited to 260°C.
2. Don't cause stress to the epoxy resin while it is exposed to high temperature.
3. Number of reflow process shall be 2 times or less.

### Recommended Soldering Pattern (Units : mm; Tolerance: ± 0.1)

Pad design for improved heat dissipation

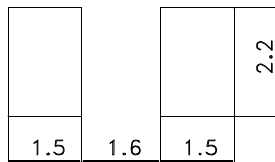

Cu-area > 16mm<sup>2</sup>  
per pad

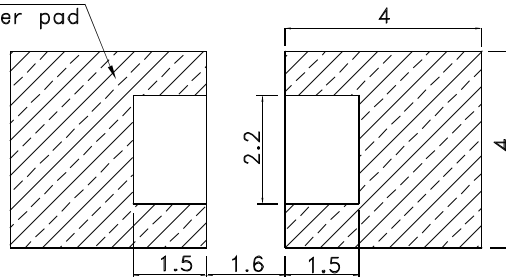

Solder resist

### Tape Specifications (Units : mm)

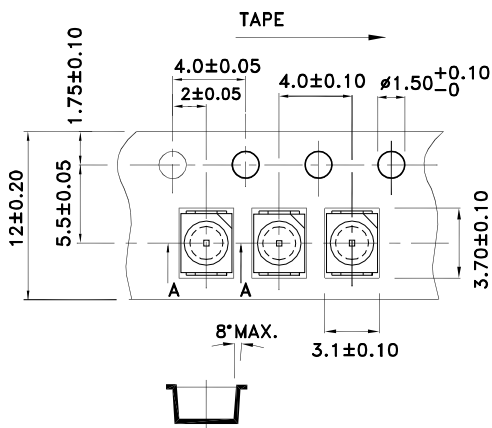

### Reel Dimension

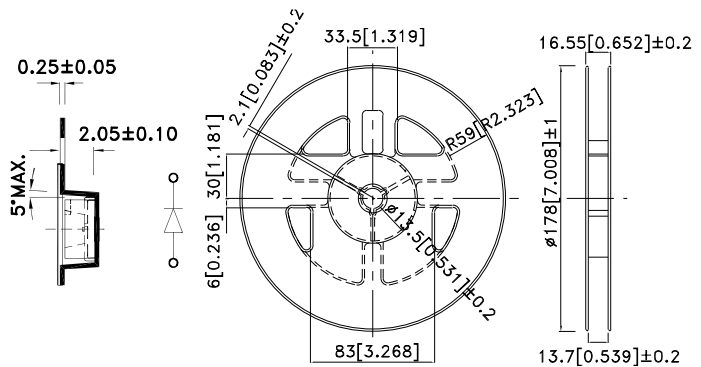

# Kingbright

## PACKING & LABEL SPECIFICATIONS

AA3528VR41S-W2-AMT

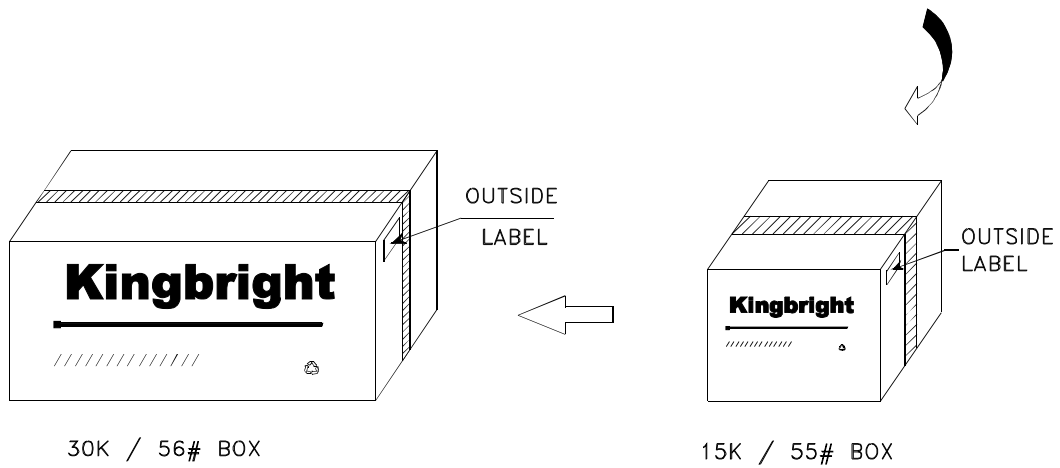
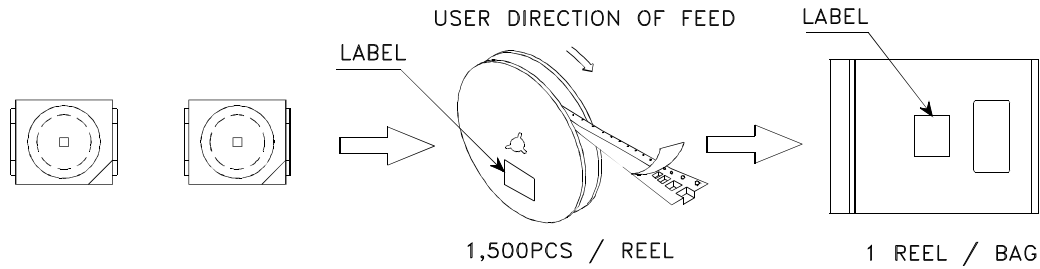

<h1>Kingbright</h1>	
P/NO: AA3528xxx	
QTY: 1,500 pcs	Q.C. <span style="border: 1px solid black; border-radius: 50%; padding: 2px;">Q C XX XX XXXX PASSED</span>
S/N: XXXX	
CODE: XXX	
LOT NO:	
 <small>XXXXXXXXXXXXXXXXXXXXXXXXXXXX</small>	
RoHS Compliant	

## Reliability Test Items And Conditions

The reliability of products shall be satisfied with items listed below

**Lot Tolerance Percent Defective (LTPD) : 10%**

No.	Test Item	Standards	Test Condition	Test Times / Cycles	Number of Damaged
1	Continuous operating test	-	Ta = 25°C ,IF = maximum rated current*	1,000 h	0 / 22
2	High Temp. operating test	EIAJ ED-4701/100(101)	Ta = 100°C IF = maximum rated current*	1,000 h	0 / 22
3	Low Temp. operating test	-	Ta = -40°C, IF = maximum rated current*	1,000 h	0 / 22
4	High temp. storage test	EIAJ ED-4701/100(201)	Ta = maximum rated storage temperature	1,000 h	0 / 22
5	Low temp. storage test	EIAJ ED-4701/100(202)	Ta = -40°C	1,000 h	0 / 22
6	High temp. & humidity storage test	EIAJ ED-4701/100(103)	Ta = 60°C, RH = 90%	1,000 h	0 / 22
7	High temp. & humidity operating test	EIAJ ED-4701/100(102)	Ta = 60°C, RH = 90% IF = maximum rated current*	1,000 h	0 / 22
8	Soldering reliability test	EIAJ ED-4701/100(301)	Moisture soak : 30°C,70% RH, 72h Preheat : 150~180°C(120s max.) Soldering temp : 260°C(10s)	3 times	0 / 18
9	Thermal shock operating test	-	Ta = -40°C(15min) ~ 100°C(15min) IF = derated current at 100°C	1,000 cycles	0 / 22
10	Thermal shock test	-	Ta = -40°C(15min) ~ maximum rated storage temperature(15min)	1,000 cycles	0 / 22
11	Electric Static Discharge (ESD)	EIAJ ED-4701/100(304)	C = 100pF , R2 = 1.5KΩ V = 250V	Once each Polarity	0 / 22
12	Vibration test	-	a = 196m/s <sup>2</sup> , f = 100~2KHz , t = 48min for all xyz axes	4 times	0 / 22

\* : Refer to forward current vs. derating curve diagram

## Failure Criteria

Items	Symbols	Conditions	Failure Criteria
luminous Intensity	Iv	IF = 20mA	Testing Min. Value < Spec.Min.Value x 0.5
Forward Voltage	Vf	IF = 20mA	Testing Max. Value ≥ Spec.Max.Value x 1.2
Reverse Current	IR	VR = Maximum Rated Reverse Voltage	Testing Max. Value ≥ Spec.Max.Value x 2.5
High temp. storage test	-	-	Occurrence of notable decoloration, deformation and cracking