

# A-Series

## CIRCUIT BREAKER

Well known for their proven reliability, Carling Technologies' A-Series hydraulic magnetic circuit breakers are compact, temperature stable and designed for precision operation in OEM markets requiring general purpose as well as full load amp applications. When front panel operation and aesthetics demand a clean, contemporary design, the visi-rocker or paddle actuators are ideally suitable. A sealed toggle actuator style is also available and ideal for harsh environment applications requiring additional sealing protection. Optional rocker-guard and push-to-reset bezels, which help prevent inadvertent actuation, are also available.

1-6 poles; ratings from 0.02 to 50 amps, up to 277VAC or 80VDC; UL Recognized, UL Listed, UL1500, UL1077, TUV, VDE & CSA

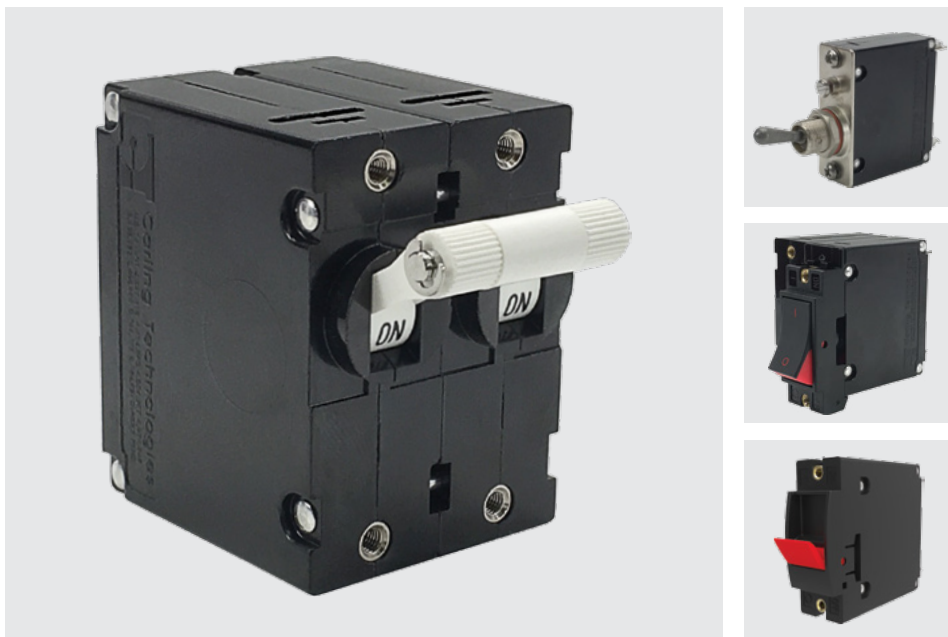

### Product Highlights:

- ♦ Up to 50 amps in a compact size
- ♦ Various actuator styles
- ♦ Sealed metal toggle option tested to MIL-PRF-55629C. Meets IP68 Requirements

### Typical Applications:

- ♦ Telecom/Datacom
- ♦ Marine
- ♦ Military
- ♦ Renewable Energy
- ♦ Generators & Welder



### Electrical

Maximum Voltage 277VAC 50/60 Hz, 80VDC  
 Current Ratings Standard current coils: 0.100, 0.250, 0.500, 0.750, 1.00, 2.50, 5.00, 7.50, 10.0, 15.0, 20.0, 25.0, 30.0, 35.0, 40.0, 50.0. Other ratings available - consult ordering scheme.  
 Standard Voltage Coils DC-6V, 12V; AC-120V, Other ratings available, consult ordering scheme.  
 Auxiliary Switch Rating SPDT; 10.1 A - 250VAC, 1.0 A-65VDC/0.5 A - 80 VDC, 0.1A - 125VAC (with gold contacts).  
 Insulation Resistance Minimum: 100 Megohms at 500 VDC  
 Dielectric Strength UL, CSA - 1500V 60 Hz for one minute between all electrically isolated terminals. A-Series rocker circuit breakers comply with the 8mm spacing & 3750V dielectric requirements from hazardous voltage to operator accessible surfaces per EN 60950 and VDE 0805.  
 Resistance, Impedance Values from Line to Load Terminal - based on Series Trip Circuit Breaker.

### Mechanical

Endurance 10,000 ON-OFF operations @ 6 per minute; with rated Current & Voltage.  
 Trip Free All A-Series Circuit Breakers will trip on overload, even when the actuator is forcibly held in the ON position.  
 Trip Indication The operating actuator moves positively to the OFF position when an overload causes the circuit breaker to trip. When mid-trip handle is specified, the handle moves to the mid position on electrical trip of the circuit breaker. When mid-trip handle with alarm switch is specified, the handle moves to the mid position & the alarm switch actuates when the circuit breaker is electrically tripped.

### Physical

Number of Poles 1 - 6 Poles (handle) and 1-3 poles (rocker) at 30 Amps or less. 1 and 2 poles at 31 Amps thru 50 Amps.  
 Internal Circuit Config. Series, (with or without auxiliary switch), Shunt and Relay with current or voltage trip coils, Dual Coil, Switch Only with or without auxiliary switch.  
 Weight Approximately 65 grams/pole. (Approximately 2.32 ounces/pole)  
 Standard Colors Housing - Black; Actuator- See Ordering Scheme.

### Environmental

Designed and tested in accordance with requirements of specification MIL-PRF-55629 & MIL-STD-202 as follows:  
 Shock Withstands 100 Gs, 6ms, sawtooth while carrying rated current per Method 213, Test Condition "I". Instantaneous and ultra-short curves tested @ 90% of rated current.  
 Vibration Withstands 0.060" excursion from 10-55 Hz, and 10 Gs 55-500 Hz, at rated current per Method 204C, Test Condition A. Instantaneous and ultrashort curves tested at 90% of rated current.  
 Moisture Resistance Method 106D; ten 24-hour cycles @ +25°C to +65°C, 80-98% RH.56 days @ +85°C, 85% RH.  
 Salt Spray Method 101, Condition A (90-95% RH @ 5% NaCl Solution, 96 hrs).  
 Thermal Shock Method 107D, Condition A (Five cycles @ -55°C to +25°C to +85°C to +25°C).  
 Operating Temperature -40° C to +85° C

RESISTANCE PER POLE VALUES from Line to Load Terminals (Values Based on Series Trip Circuit Breaker)

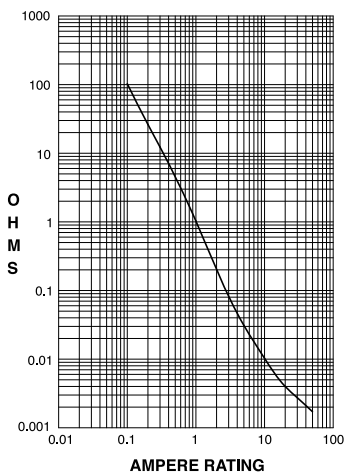

CURRENT (AMPS)	TOLERANCE (%)
0.10 - 5.0	15
5.1 - 20.0	25
20.1 - 50.0	35

Pulse Tolerance Curves

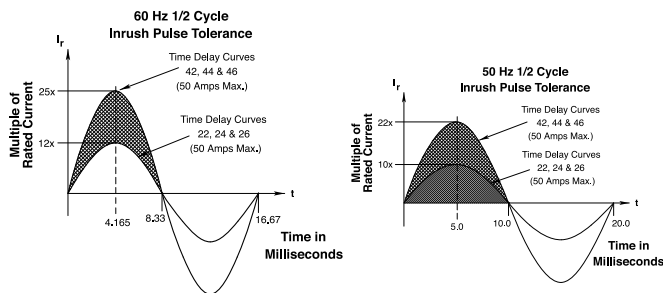

\*Manufacturer reserves the right to change product specification without prior notice.

Electrical Tables

**Table A:** Lists UL Recognized & CSA Accepted configurations and performance capabilities as a Component Supplementary Protector.

A-SERIES TABLE A: COMPONENT SUPPLEMENTARY PROTECTORS											
Circuit Configuration	Voltage			Current Rating		Short Circuit Capacity (Amps)		Application Codes		Construction Notes	
	Max Rating	Frequency	Phase	Full Load Amps	General Purpose Amps	UL / CSA		UL	CSA		
						With Backup Fuse	Without Backup Fuse				
Series	32	DC	---	0.02 - 15	---	---	5000	TC1, OL1, U2	TC1, OL1, U2		
	65	DC	---	31 - 50	---	---	7500	TC1, 2, OL1, U1	TC1, 2, OL1, U1		
	80	DC	---	0.02 - 30	---	---	7500	TC1, 2, OL1, U1	TC1, 2, OL1, U1		
				---	31 - 50	---	7500	TC1, 2, OL0, U1	TC1, 2, OL0, U1		
	125	50 / 60	1	0.02 - 30	---	---	3000	TC1, OL1, U2	TC1, OL1, U2	Rocker Version	
	125	50 / 60	1	1 - 50	---	---	2000	TC1, OL1, U2	TC1, OL1, U2		
	125	50 / 60	1 <sup>4</sup>	1 - 50	---	---	1000	TC1, OL1, U2	TC3, OL1, U3		
	125 / 250	50 / 60	1 <sup>3</sup>	0.02 - 30	---	---	3000	TC1, 2, OL1, U2	TC1, 2, OL1, U2	Rocker Version	
	125 / 250	50 / 60	1 <sup>3</sup>	0.02 - 50	---	---	3000	TC1, 2, OL1, U2	TC1, 2, OL1, U2	Handle	
	250	50 / 60	1	0.02 - 30	---	---	1500	TC1, 2, OL0, U2	TC1, 2, OL0, U2	Single Pole Break	
				0.02 - 30	---	---	3000	TC1, OL1, U2	TC1, OL1, U2	Two Pole Break	
				---	---	---	3000	TC1, 2, OL0, U1	TC1, 2, OL0, U1		
				1 <sup>4</sup>	1 - 50	---	1000	TC1, OL1, U2	TC3, OL1, U3		
				3	0.02 - 30	---	5000 <sup>2</sup>	---	TC1, 2, OL1, C1	TC1, 2, OL1, C1	
			31 - 50	---	2000 <sup>1</sup>	---	TC1, 2, OL1, C1	TC1, 2, OL1, C1			
277	50 / 60	1	0.02 - 30	---	---	5000 <sup>1</sup>	---	TC1, 2, OL1, C1	TC1, 2, OL1, C1		
Dual Coil	32	DC	---	0.02 - 50	---	---	5000	TC1, OL1, U2	TC1, OL1, U2		
	65	DC	---	0.02 - 50	---	---	7500	TC1, 2, OL1, U1	TC1, 2, OL1, U1		
	80	DC	---	0.02 - 30	---	---	7500	TC1, 2, OL1, U1	TC1, 2, OL1, U1		
				---	31 - 50	---	7500	TC1, 2, OL0, U1	TC1, 2, OL0, U1		
	125	50 / 60	1	0.02 - 30	---	---	3000	TC1, OL1, U2	TC1, OL1, U2	Rocker Version	
				1 - 50	---	---	2000	TC1, OL1, U2	TC1, OL1, U2		
	125	50 / 60	1 <sup>4</sup>	0.02 - 30	---	---	1000	TC1, OL1, U2	TC3, OL1, U3		
	125 / 250	50 / 60	1 <sup>3</sup>	0.02 - 30	---	---	3000	TC1, 2, OL1, U1	TC1, 2, OL1, U1	Rocker Version	
	125 / 250	50 / 60	1 <sup>3</sup>	0.02 - 50	---	---	3000	TC1, 2, OL1, U2	TC1, 2, OL1, U2		
	250	50 / 60	1	0.02 - 30	---	---	1500	TC1, OL0, U2	TC1, OL0, U2	Single Pole Break	
				0.02 - 30	---	---	3000	TC1, OL1, U2	TC1, OL1, U2	Two Pole Break	
				---	31 - 50	---	3000	TC1, 2, OL0, U1	TC1, 2, OL0, U1		
				1 <sup>4</sup>	1 - 50	---	1000	TC1, OL1, U2	TC3, OL1, U3		
				3	0.02 - 30	---	5000 <sup>2</sup>	---	TC1, 2, OL1, C1	TC1, 2, OL1, C1	
			31 - 50	---	2000 <sup>1</sup>	---	TC1, 2, OL1, C1	TC1, 2, OL1, C1			
277	50 / 60	1	0.02 - 30	---	---	5000 <sup>1</sup>	---	TC1, 2, OL1, U1	TC1, 2, OL1, U1		
Shunt	80	DC	---	0.02 - 30	---	---	7500	TC1, 2, OL1, U1	TC1, 2, OL1, U1		
	125 / 250	50 / 60	1	0.02 - 30	---	---	3000	TC1, 2, OL1, U1	TC1, 2, OL1, U1		
				0.02 - 30	---	---	3000	TC1, 2, OL1, U1	TC1, 2, OL1, U1		
	250	50 / 60	3	0.02 - 30	---	---	5000 <sup>2</sup>	---	TC1, 2, OL1, C1	TC1, 2, OL1, C1	
				0.02 - 30	---	---	5000 <sup>2</sup>	---	TC1, 2, OL1, C1	TC1, 2, OL1, C1	
277	50 / 60	1	0.02 - 30	---	---	5000 <sup>1</sup>	---	TC1, 2, OL1, C1	TC1, 2, OL1, C1		
Relay	80	DC	---	0.02 - 30	---	---	7500	TC1, 2, OL1, U1	TC1, 2, OL1, U1		
	125 / 250	50 / 60	1 <sup>3</sup>	0.02 - 30	---	---	3000	TC1, 2, OL1, U1	TC1, 2, OL1, U1		
				0.02 - 30	---	---	3000	TC1, 2, OL1, U1	TC1, 2, OL1, U1		
	250	50 / 60	3	0.02 - 30	---	---	5000 <sup>2</sup>	---	TC1, 2, OL1, C1	TC1, 2, OL1, C1	
				0.02 - 30	---	---	5000 <sup>2</sup>	---	TC1, 2, OL1, C1	TC1, 2, OL1, C1	
277	50 / 60	1	0.02 - 30	---	---	5000 <sup>1</sup>	---	TC1, 2, OL1, C1	TC1, 2, OL1, C1		
Switch Only	65	DC	---	0.02 - 50	---	not applicable					
	80	DC	---	0.02 - 30	---	not applicable					
	250	50 / 60	1	---	31 - 50	not applicable					
				3	0.02 - 50	not applicable					
	277	50 / 60	1	0.02 - 30	31 - 50	not applicable					

Notes:  
 1 Requires branch circuit backup with a UL LISTED Type K5 or RK5 fuse (15A minimum) at no more than 4 times the rating of the protector.  
 2 Same as note 1, except that backup fuse is limited to 80 A maximum.  
 3 2 pole protector required (with one pole per power line) for: 125/250 VAC, 1 pole protector required for: 125 VAC, 1Ø Power System.  
 4 Satisfies the requirements of clause 11.2.8.2.5 of CSA STD C22.2 No 100 for the use of supplementary protectors with portable generators.

## Electrical Tables

**Table B:** Lists UL Recognized, CSA Accepted, VDE & TUV Certified configurations & performance capabilities as a Component Supplementary Protector.

A-SERIES TABLE B: COMPONENT SUPPLEMENTARY PROTECTORS															
CIRCUIT CONFIGURATION	VOLTAGE			CURRENT RATING		SHORT CIRCUIT CAPACITY (AMPS)						APPLICATION CODES		VDE CONSTRUCTION NOTES	
	MAX. RATING	FREQUENCY	PHASE	FULL LOAD AMPS	GENERAL PURPOSE AMPS <sup>1</sup>	UL/CSA		VDE		TUV		UL	CSA		
						WITH BACKUP FUSE	WITHOUT BACKUP FUSE	(Inc) WITH BACKUP FUSE	(Inc) WITHOUT BACKUP	(Inc) WITH BACKUP FUSE	(Inc) WITHOUT BACKUP				
SERIES	65	DC	—	0.10 - 50	—	—	7500	—	—	5000	3000	TC1,2, OL1,U1	TC1,2, OL1,U1	World Market Breaker TUV Only	
	80	DC	—	0.10 - 30	—	—	7500	3000	1500	3000	1500	TC1,2, OL1,U1	TC1,2, OL1,U1	Handle Version 1 Pole Only	
				31 - 50	31 - 50	—	7500	3000	1500	3000	1500	TC1,2, OL0,U1	TC1,2, OL0,U1	Handle Version 1 Pole Only	
				0.10 - 30	—	—	7500	3000	1500	3000	1500	TC1,2, OL1,U1	TC1,2, OL1,U1	Rocker Version 1 - 3 Poles	
				31 - 32	—	—	7500	3000	1500	3000	1500	TC1,2, OL1,U1	TC1,2, OL1,U1	Rocker Version 2 Pole Only	
				31 - 50	31 - 50	—	7500	3000	1500	3000	1500	TC1,2, OL0,U1	TC1,2, OL0,U1	Rocker Version 1 Pole Only	
	250	50 / 60	1	0.10 - 30	—	—	3000	3000	1500	5000	1500	TC1,2, OL1,U1	TC1,2, OL1,U1	Rocker Version 1 - 3 Poles	
				31 - 50	31 - 50	—	3000	—	—	5000	1500	TC1,2, OL0,U1	TC1,2, OL0,U1	Rocker Version 1 - 3 Poles	
				31 - 32	—	—	3000	6000	1500	5000	1500	TC1,2, OL1,U1	TC1,2, OL1,U1	Rocker Version 2 Pole Only	
			1	0.10 - 30	—	—	3000	6000	1500	5000	1500	TC1, OL1,U2	TC1, OL1,U2	Rocker Version 2 Pole Only	
			1 <sup>4</sup>	1 - 50	—	—	1000	—	—	5000	1500	TC1, OL1,U2	TC3, OL1,U3	Rocker Version 1 - 3 Poles	
			3	0.10 - 30	—	—	5000 <sup>3</sup>	—	3000	1500	3000	1500	TC1,2, OL1,C1	TC1,2, OL1,C1	Rocker Version 1 - 3 Poles
			31 - 50	—	—	2000 <sup>2</sup>	—	3000	1500	3000	1500	TC1,2, OL1,C1	TC1,2, OL1,C1	Rocker Version 1 - 3 Poles	
	DUAL COIL	80	DC	—	0.10 - 30	—	—	7500	3000	1500	3000	1500	TC1,2, OL1,U1	TC1,2, OL1,U1	Rocker Version 1 - 3 Poles
250		50 / 60	1	0.10 - 30	—	—	3000	3000	1500	5000	1500	TC1,2, OL1,U1	TC1,2, OL1,U1	Rocker Version 1 - 3 Poles	
			30 - 50	31 - 50	—	3000	—	—	5000	1500	TC1,2, OL0,U1	TC1,2, OL0,U1	Rocker Version 1 - 3 Poles		
			3	0.10 - 30	—	—	5000 <sup>3</sup>	—	3000	1500	3000	1500	TC1,2, OL1,C1	TC1,2, OL1,C1	Rocker Version 1 - 3 Poles
31 - 50	—	—	2000 <sup>2</sup>	—	—	—	3000	1500	TC1,2, OL1,C1	TC1,2, OL1,C1	Rocker Version 1 - 3 Poles				
SHUNT	80	DC	—	0.10 - 30	—	—	7500	3000	1500	3000	1500	TC1,2, OL1,U1	TC1,2, OL1,U1	Handle Version 1 Pole Only	
				0.10 - 30	—	—	7500	3000	1500	3000	1500	TC1,2, OL1,U1	TC1,2, OL1,U1	Rocker Version 1 - 3 Poles	
	250	50 / 60	1	0.10 - 30	—	—	3000	3000	1500	5000	1500	TC1,2, OL1,U1	TC1,2, OL1,U1	Rocker Version 1 - 3 Poles	
				30 - 50	31 - 50	—	3000	—	—	5000	1500	TC1,2, OL0,U1	TC1,2, OL0,U1	Rocker Version 1 - 3 Poles	
			3	0.10 - 30	—	—	5000 <sup>3</sup>	—	3000	1500	3000	1500	TC1,2, OL1,C1	TC1,2, OL1,C1	Rocker Version 1 - 3 Poles
				31 - 50	—	—	2000 <sup>2</sup>	—	—	—	3000	1500	TC1,2, OL1,C1	TC1,2, OL1,C1	Rocker Version 1 - 3 Poles

Notes:

- 1 General Purpose Ratings for UL/CSA Only.
- 2 Requires branch circuit backup with a UL LISTED Type K5 or RK5 fuse (15A minimum) at no more than 4 times the rating of the protector.
- 3 Same as note 2, except that backup fuse is limited to 80 A maximum.
- 4 Satisfies the requirements of clause 11.2.8.2.5 of CSA STD C22.2 No 100 for the use of supplementary protectors with portable generators.

## Electrical Tables

**Table C:** Lists UL Recognized, CSA Accepted configurations and performance capabilities as Protectors, Supplementary for Marine Electrical and Fuel Systems (Guide PEQZ2, File E75596). Ignition Protected per UL 1500. UL Classified Small Craft Electrical Devices, Marine in accordance with ISO 8846 (Guide UZMK, File MQ1515) as Marine Supplementary Protectors.

A-SERIES TABLE C: UL1500 (Marine Ignition Protected)							
CIRCUIT CONFIGURATION	VOLTAGE			CURRENT RATING	SHORT CIRCUIT CAPACITY (AMPS)	APPLICATION CODES	
	MAX. RATING	FREQUENCY	PHASE	FULL LOAD AMPS	WITHOUT BACKUP FUSE	UL	CSA
SERIES	14 <sup>1</sup>	DC	---	0.02 - 50	5000	TC1,OL1,U1	TC1,OL1,U1
	32 <sup>1</sup>	DC	---	0.02 - 50	5000	TC1,OL1,U2	TC1,OL1,U2
	65	DC	---	0.02 - 50	3000	TC1,OL1,U1	TC1,OL1,U1
	125	50 / 60	1	0.02 - 50	3000	TC1,OL1,U2	TC1,OL1,U2
	125 / 250	50 / 60	1 <sup>2</sup>	0.02 - 50	3000	TC1,OL1,U2	TC1,OL1,U2
	250	50 / 60	1	0.02 - 30	1500	TC1,OL1,U1	TC1,OL1,U1

Notes:

1 Available with special catalog number only (consult factory).

2 2 pole protector required (with one per power line) for 125 / 250 VAC. 1 pole protector required for 125 VAC 1 phase power system

**Table D:** Lists UL Listed configurations and performance capabilities as Circuit Breakers for use in Communications Equipment (Guide DITT, File E189195), under UL489A.

A-SERIES TABLE D: UL489A (COMMUNICATIONS EQUIPMENT)				
CIRCUIT CONFIGURATION	VOLTAGE		CURRENT RATING	INTERRUPTING CAPACITY (AMPS)
	MAX. RATING	FREQUENCY	GENERAL PURPOSE AMPS	WITHOUT BACKUP FUSE
SERIES	80	DC	0.10 - 50	5000
	80	DC	60 - 90 <sup>1</sup>	5000

Notes:

1 Parallel Pole Construction

## Agency Certifications

### UL Recognized

UL Standard 1077



Component Recognition Program as Protectors Supplementary (Guide CCN/QVNU2, File E75596)

UL Standard 508



Switches, Industrial Control (Guide CCN/NRNT2, File E148683)

UL Standard 1500



Protectors, Supplementary for Marine Electrical & Fuel Systems (Guide PEQZ2, File E75596) Ignition Protection

### UL Listed

UL Standard 489A



Communications Equipment (Guide CCN/DITT, File E189195)

### CSA Accepted



Component Supplementary Protector under Class 3215 30, File 047848 0 000 CSA Standard C22.2 No. 235

### TUV Certified



EN60934, under License No. R72103448

### VDE Certified



EN60934, VDE 0642 under File No. 10537





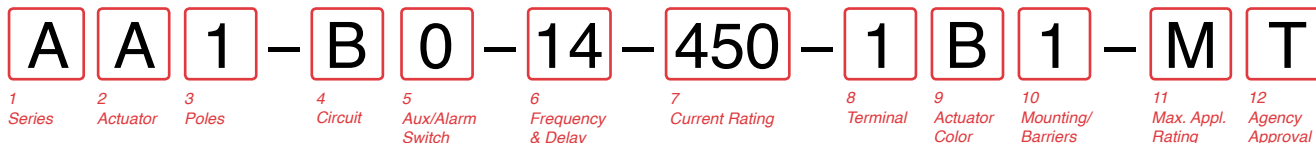

**1 SERIES**  
A

**2 ACTUATOR <sup>1</sup>**  
A Handle, one per pole  
S Mid-Trip Handle, one per pole  
T Mid-Trip Handle, one per pole & Alarm Switch

**3 POLES <sup>2</sup>**  
1 One  
2 Two  
3 Three  
4 Four

**4 CIRCUIT**  
B Series Trip (Current)

**5 AUXILIARY/ALARM SWITCH <sup>2</sup>**  
0 without Aux Switch  
1 S.P.D.T., 0.093 Q.C. Term.  
2 S.P.D.T., 0.110 Q.C. Term.

**6 FREQUENCY & DELAY**  
11 DC Ultra Short  
12 DC Short  
14 DC Medium  
16 DC Long

**7 CURRENT RATING (AMPERES)**

CODE	AMPERES						
210	0.100	285	0.850	455	5.500	613	13.000
215	0.150	290	0.900	460	6.000	614	14.000
220	0.200	295	0.950	465	6.500	615	15.000
225	0.250	410	1.000	470	7.000	616	16.000
230	0.300	512	1.250	475	7.500	617	17.000
235	0.350	415	1.500	480	8.000	618	18.000
240	0.400	517	1.750	485	8.500	620	20.000
245	0.450	420	2.000	490	9.000	622	22.000
250	0.500	522	2.250	495	9.500	624	24.000
255	0.550	527	2.750	610	10.000	625	25.000
260	0.600	430	3.000	710	10.500	630	30.000
265	0.650	435	3.500	611	11.000	635	35.000
270	0.700	440	4.000	711	11.500	640	40.000
275	0.750	445	4.500	612	12.000	645	45.000
280	0.800	450	5.000	712	12.500	650	50.000

**8 TERMINAL <sup>5</sup>**  
1 <sup>6</sup> Push-On 0.250 Tab (Q.C.)  
2 Screw 8-32 with upturned lugs  
3 <sup>7</sup> Screw 8-32 (Bus Type)  
4 Screw 10-32 with upturned lugs  
5 <sup>7</sup> Screw 10-32 (Bus Type)  
6 Screw 8-32 with upturned lugs & 30° bend  
7 Screw 8-32 (Bus Type) & 30° bend  
8 Screw 10-32 with upturned lugs & 30° bend  
9 Screw 10-32 (Bus Type) & 30° bend  
B Screw M5 with upturned lugs  
F Screw M5 with upturned lugs & 30° bend  
G Screw M5 (Bus Type) & 30° bend  
H Screw M5 (Bus Type)  
M <sup>7</sup> M6 Threaded Stud  
P <sup>8</sup> Printed Circuit Board Terminals  
Q <sup>9</sup> Push-In Stud

**9 ACTUATOR COLOR & LEGEND**

Actuator Color	ON-OFF	Dual	Legend Color
White	B	1	Black
Black	D	2	White
Red	G	3	White
Green	J	4	White
Blue	L	5	White
Yellow	N	6	Black
Gray	Q	7	Black
Orange	S	8	Black
Black (short handle) <sup>10</sup>	U	9	White

**10 MOUNTING / BARRIERS**

MOUNTING STYLE	BARRIERS
<b>Threaded Insert, 2 per pole</b>	
1 6-32 x 0.195 inches	no
2 6-32 x 0.195 inches	yes
3 ISO M3 x 5mm	no
4 ISO M3 x 5mm (multipole only)	yes
<b>Front panel Snap-In, 0.75" wide bezel</b>	
5 without Handguard	no
6 without Handguard (multipole only)	yes
<b>Front panel Snap-In, 0.96" wide bezel</b>	
7 without Handguard, 1-pole 0.96" wide;	no
8 multipole units have .105" bezel overhang on all sides	yes
9 without Handguard, 1-pole 0.96" wide;	yes
10 multipole units have .105" bezel overhang on all sides	yes

**11 MAXIMUM APPLICATION RATING**  
M 80 DC

**12 AGENCY APPROVAL**  
T UL489A Listed  
K UL489A Listed, VDE Certified  
J UL489A Listed, TUV Certified

- Notes:
- Actuator Code:  
A: Handle tie pin spacer(s) and retainers provided un-assembled with multi-pole units.  
S: Handle moves to mid-position only upon electrical trip of the breaker.  
T: Handle moves to mid-position and alarm switch activates only upon electrical trip of the breaker.
  - On multi-pole breakers, one auxiliary switch is supplied, mounted in the extreme right pole.
  - VDE Certified to 30 amps. UL489A Listed to 50 amps.
  - VDE Certification available with single pole breakers only. UL489A Listing available with one and two pole breakers.
  - Screw Terminals are recommended on ratings greater than 20 amps. Ratings over 30 amps are only available with Terminal Codes 5, 9 G, H, M and Q.
  - Terminal Code 1 (Push-On) available up to 25 amps with VDE Certification and 30 amps with UL489A Listing, but is not recommended over 20 amps.
  - Terminal Codes 3, 5 and H (Bus Type) with VDE, are supplied with Lock Washers, and Terminal Code M (M6 Threaded Stud) with VDE is supplied with Lock and Flat Washers. These breakers are only VDE Certified when the washers are used.
  - Single pole breakers with Terminal Code P (Printed Circuit Board) are available up to 30 amps with VDE Certification and 50 amps with UL489A Listing.
  - Terminal Code Q not available with VDE certification.
  - Single pole only.





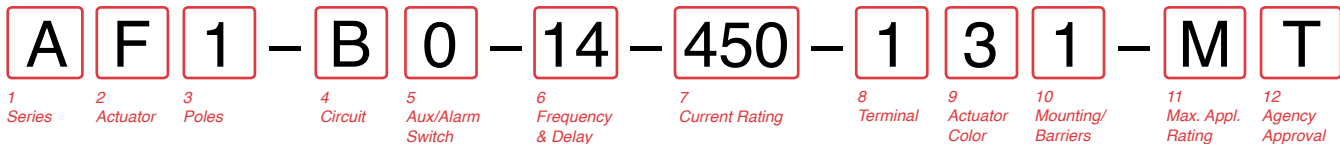

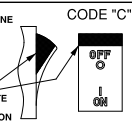
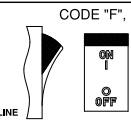
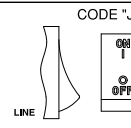
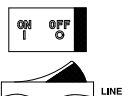

**1 SERIES**  
A

**2 ACTUATOR 1**  
**Two Color Visi-Rocker**  
**C** Indicate ON, vertical legend  
**D** Indicate ON, horizontal legend  
**F** Indicate OFF, vertical legend  
**G** Indicate OFF, horizontal legend  
**Single color**  
**J** Vertical legend  
**K** Horizontal legend  
**Push-To-Reset, Visi-Rocker**  
**N** Indicate OFF, vertical legend  
**O** Indicate OFF, horizontal legend  
**Push-To-Reset, Single color**  
**R** Vertical legend  
**U** Horizontal legend

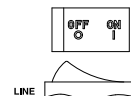
ROCKER STYLE DESCRIPTIONS			
	INDICATE "ON"	INDICATE "OFF"	SINGLE COLOR
VERTICAL STYLE	 CODE "C" <small>INDICATE COLOR LOCATION</small>	 CODE "F", "N"	 CODE "J", "R"
	 CODE "D"	 CODE "G", "O"	 CODE "K", "U"

**3 POLES 2**  
 1 One  
 2 Two  
 3 Three

**4 CIRCUIT**  
**B** Series Trip (Current)

**5 AUXILIARY / ALARM SWITCH 2**  
**0** without Aux Switch  
**1** S.P.D.T., 0.093 Q.C. Term.  
**2** S.P.D.T., 0.110 Q.C. Term.  
**7** S.P.S.T., 0.110 Q.C. Term. (Gold Contacts)  
**8** S.P.S.T., 0.187 Q.C. Term.  
**9** S.P.D.T., 0.187 Q.C. Term.

**6 FREQUENCY & DELAY**  
**11** DC Ultra Short  
**12** DC Short  
**14** DC Medium  
**16** DC Long  
**52** DC, Short, Hi-Inrush  
**54** DC, Medium, Hi-Inrush  
**56** DC, Long, Hi-Inrush

**7 CURRENT RATING (AMPERES)**

CODE	AMPERES	285	0.850	455	5.500	613	13.000
210	0.100	285	0.850	455	5.500	613	13.000
215	0.150	290	0.900	460	6.000	614	14.000
220	0.200	295	0.950	465	6.500	615	15.000
225	0.250	410	1.000	470	7.000	616	16.000
230	0.300	512	1.250	475	7.500	617	17.000
235	0.350	415	1.500	480	8.000	618	18.000
240	0.400	517	1.750	485	8.500	620	20.000
245	0.450	420	2.000	490	9.000	622	22.000
250	0.500	522	2.250	495	9.500	624	24.000
255	0.550	527	2.750	610	10.000	625	25.000
260	0.600	430	3.000	710	10.500	630	30.000
265	0.650	435	3.500	611	11.000	635	35.000
270	0.700	440	4.000	711	11.500	640	40.000
275	0.750	445	4.500	612	12.000	645	45.000
280	0.800	450	5.000	712	12.500	650	50.000

**8 TERMINAL 5**  
**1** 6 Push-On 0.250 Tab (Q.C.)  
**2** Screw 8-32 with upturned lugs  
**3** 7 Screw 8-32 (Bus Type)  
**4** 7 Screw 10-32 with upturned lugs  
**5** 7 Screw 10-32 (Bus Type)  
**6** Screw 8-32 with upturned lugs & 30° bend  
**7** Screw 8-32 (Bus Type)  
**8** Screw 10-32 with upturned lugs & 30° bend  
**9** Screw 10-32 (Bus Type) & 30° bend  
**B** Screw M5 with upturned lugs  
**F** Screw M5 with upturned lugs & 30° bend  
**G** Screw M5 (Bus Type) & 30° bend  
**H** Screw M5 (Bus Type)  
**M** 7 M6 Threaded Stud  
**P** 8 Printed Circuit Board Terminals  
**Q** 9 Push-In Stud

**9 ACTUATOR COLOR & LEGEND**

Actuator or Visi-Color 10	Marking:		Marking Color	
	ON-OFF	Dual 10	Single Color	Visi-Rocker
White	B	1	Black	White
Black	D	2	White	n/a
Red	G	3	White	Red
Green	J	4	White	Green
Blue	L	5	White	Blue
Yellow	N	6	Black	Yellow
Gray	Q	7	Black	Gray
Orange	S	8	Black	Orange

**10 MOUNTING / BARRIERS 11**  
**STANDARD ROCKER BEZEL**  
**Threaded Insert, 2 per pole**  
**1** 6-32 x 0.195 inches  
**A** 6-32 X 0.195 inches (multi-pole units only)  
**2** ISO M3 x 5mm  
**B** ISO M3 x 5mm (multi-pole units only)  
**ROCKERGUARD & PUSH-TO-RESET BEZEL**  
**Threaded Insert, 2 per pole**  
**3** 6-32 x 0.195 inches  
**C** 6-32 x 0.195 inches (multi-pole units only)  
**4** ISO M3 x 5mm  
**D** ISO M3 x 5mm (multi-pole units only)  
**FRONT PANEL SNAP-IN BRACKET, 0.744" [18.90mm] wide bezel**  
**8** without Rockerguard (single pole units only)  
**H** with Rockerguard (single pole units only)  
**FRONT PANEL SNAP-IN BRACKET, 0.96" [24.48mm] wide bezel**  
**9** without Rockerguard (single pole units only)  
**J** with Rockerguard (single pole units only)

**11 MAXIMUM APPLICATION RATING**  
**M** 80 DC

**12 AGENCY APPROVAL**  
**T** UL489A Listed  
**K** UL489A Listed, VDE Certified  
**J** UL489A Listed, TUV Certified

Notes:  
 1 Push-To-Reset actuators have OFF portion of rocker shrouded.  
 2 Multi-pole breakers have all breakers identical except when specifying Auxiliary switch and/or mixed poles, and have one rocker per breaker.  
 3 Auxiliary Switch breakers with Series Trip circuits: ≤ 30A, are supplied with standard half shells. 30-50A are supplied with extended boat (B-Style) half shells.  
 4 VDE Certification available with single pole breakers only. UL489A Listing available with one and two pole breakers.  
 5 Screw Terminals are recommended on ratings greater than 20 amps. Ratings over 30 amps are only available with Terminal Codes 5, 9, G, H, M and Q.  
 6 Terminal Code 1 (Push-On) available up to 25 amps with TUV or VDE Certification and 30 amps with UL489A Listing, but is not recommended over 20 amps.  
 7 Terminal Codes 3, 5 and H (Bus Type) with TUV or VDE, are supplied with Lock Washers, and Terminal Code M (M6 Threaded Stud) with VDE is supplied with Lock and Flat Washers. These breakers are only TUV or VDE Certified when the washers are used.  
 8 Single pole breakers with Terminal Code P (Printed Circuit Board) are available up to 30 amps with VDE Certification and 50 amps with UL489A Listing.  
 9 Terminal Code Q not available with VDE certification.  
 10 Color shown is Visi and Legend with remainder of rocker black. Dual = ON-OFF/I-O legend.  
 11 Legend on Push-to-reset bezel/shroud is white with single color actuator codes R & U. Legend on Push-To-Reset bezel/shroud matches Visi-Color of rocker with actuator codes N & O. Rockerguard available with actuator codes C through K

## Circuit & Terminal Diagrams: in. [mm]

CIRCUIT BREAKER PROFILE	CIRCUIT SCHEMATIC		CIRCUIT SCHEMATIC	
	ANSI	CIRCUIT CODE	ANSI	CIRCUIT CODE
<b>2 TERMINALS</b> 	<b>SWITCH ONLY (NO COIL)</b> 	<b>A</b> <b>0</b>	<b>SERIES TRIP</b> 	<b>BC</b> <b>0</b>
<b>5 TERMINALS</b> 	<b>SWITCH ONLY (NO COIL) WITH AUXILIARY SWITCH</b> 	<b>A</b> <b>1</b> <b>2</b> <b>3</b> <b>4</b>	<b>SERIES TRIP WITH (3) AUXILIARY/ALARM SWITCH</b> 	<b>BC</b> <b>1</b> <b>2</b> <b>3</b> <b>4</b>
<b>3 TERMINALS</b> 	<b>SHUNT TRIP</b> 	<b>DE</b> <b>0</b>	<b>DUAL COIL; SERIES TRIP CURRENT COIL, SHUNT TRIP VOLTAGE COIL</b> 	<b>H</b> <b>0</b>
<b>4 TERMINALS</b> 	<b>RELAY TRIP</b> 	<b>FG</b> <b>0</b>	<b>DUAL COIL; SERIES TRIP CURRENT COIL, RELAY TRIP VOLTAGE COIL</b> 	<b>K</b> <b>0</b>

### AUXILIARY/ALARM SWITCH TERMINAL DETAIL



- Notes:
- 1 All dimensions are in inches [millimeters].
  - 2 Tolerance ±.020 [.51] unless otherwise specified.
  - 3 Alarm Switch available with .110 x .020 Q.C. & Solder Lug Terminals Only.

## Circuit & Terminal Diagrams: in. [mm]

HANDLE POSITION VS. AUX/ALARM SWITCH MODE						
CIRCUIT BREAKER MODE	STANDARD C/B		MID TRIP C/B		MID TRIP C/B	
	HANDLE POSITION	AUX. SWITCH MODE	HANDLE POSITION	ALARM SWITCH MODE	HANDLE POSITION	AUX. SWITCH MODE (w/o ALARM SWITCH)
OFF						
ON						
ELECTRICAL TRIP						

TERMINAL DIMENSIONAL DETAIL & RATING						
TAB (Q.C.) 30 AMP	UPTURN LUG #8-32 30 AMP #10-32 30 AMP M5 30 AMP M4 30 AMP	BUS #8-32 30 AMP #10-32 50 AMP	QC SOLDER LUG 30 AMP	.110 QC VOLTAGE COILS ONLY	M6 STUD 50 AMP	PUSH-IN STUD 50 AMP

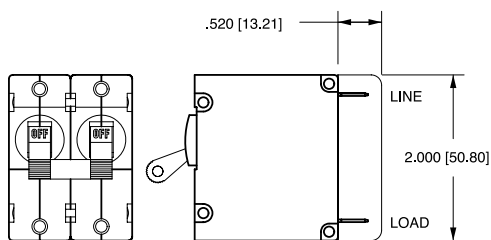
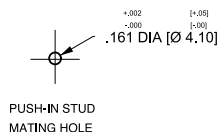
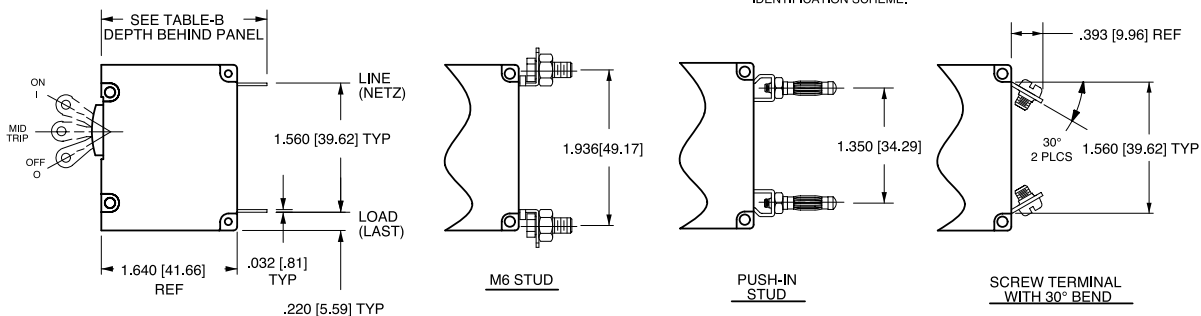

TABLE A TIGHTENING TORQUE SPECIFICATIONS	
THREAD SIZE	TORQUE
#6-32 & M3 MOUNTING HARDWARE	7-9 IN-LBS [0.8-1.0 NM]
#8-32 & M4 THREAD TERMINAL SCREW	12-15 IN-LBS [1.4-1.7 NM]
#10-32 & M5 THREAD TERMINAL SCREW	15-20 IN-LBS [1.7-2.3 NM]

TABLE B		DEPTH BEHIND PANEL
TERMINAL DESCRIPTION		
MAIN	TAB (Q.C.)	2.000 [50.80]
	SCREW TYPE	2.032 [51.60]
SHUNT, RELAY & DUAL COIL	TAB (Q.C.)	2.207 [56.10]
	SCREW #8-32 W/UPTURNED LUGS	2.364 [60.05]
AUX. SWITCH*	.093 TAB (Q.C.)	2.095 [53.20]
	.110 TAB (Q.C.)	2.189 [55.60]
	SOLDER TYPE	1.970 [50.00]

\* AVAILABLE ON SERIES TRIP AND SWITCH ONLY CIRCUITS. WHEN CALLED FOR ON MULTI-POLE UNITS, ONLY ONE AUX. SWITCH IS NORMALLY SUPPLIED, AS SHOWN IN MULTI-POLE IDENTIFICATION SCHEME.



- Notes:
- 1 All dimensions are in inches [millimeters].
  - 2 Tolerance  $\pm 0.02$  [.51] unless otherwise specified.
  - 3 Alarm Switch available with .110 x .020 QC & solder lug terminals only.

## Dimensional Specifications: in. [mm]

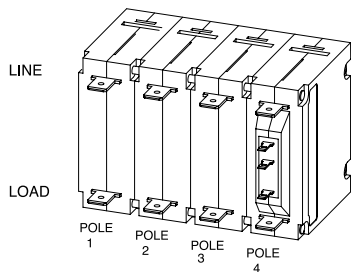
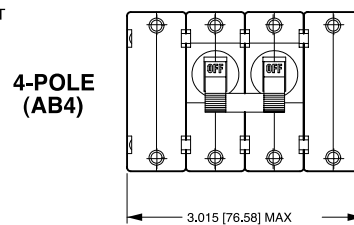
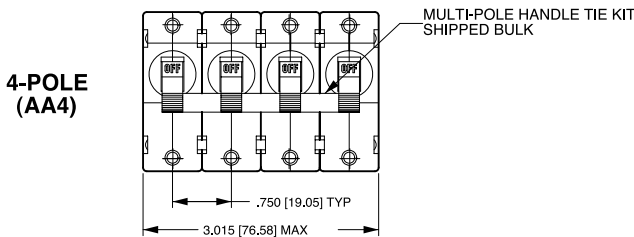
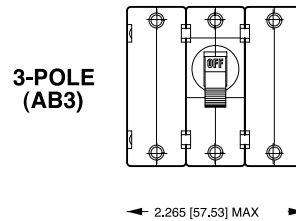
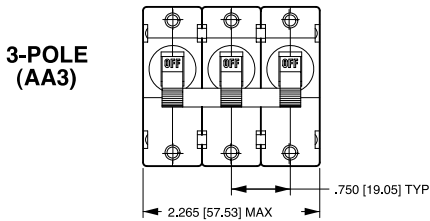
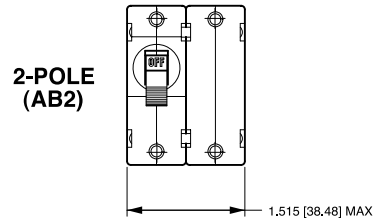
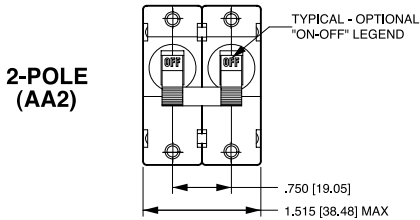
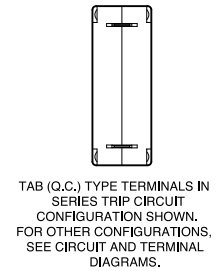
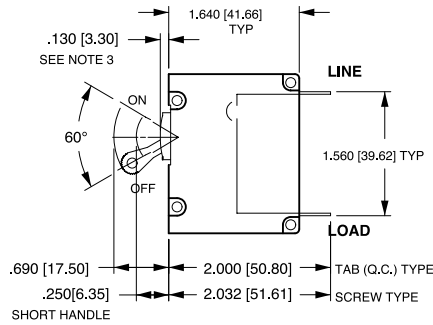
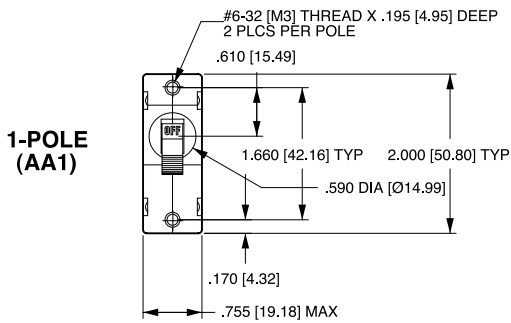

MULTI-POLE IDENTIFICATION SCHEME AS VIEWED FROM TERMINAL END OF BREAKER.

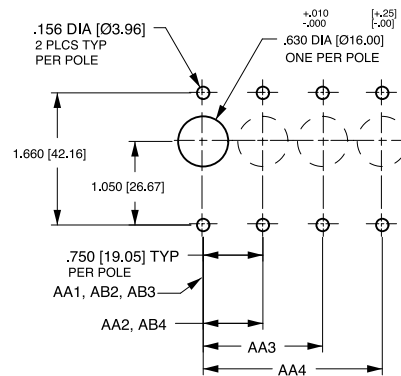

**PANEL CUTOUT DETAIL**  
TOLERANCES ±.005 [±.12] UNLESS OTHERWISE SPECIFIED

**Notes:**

- 1 All dimensions are in inches [millimeters].
- 2 Tolerance ± 0.20 [.51] unless otherwise specified.
- 3 For agency code P = .150 [3.81].

## Dimensional Specifications: in. [mm]

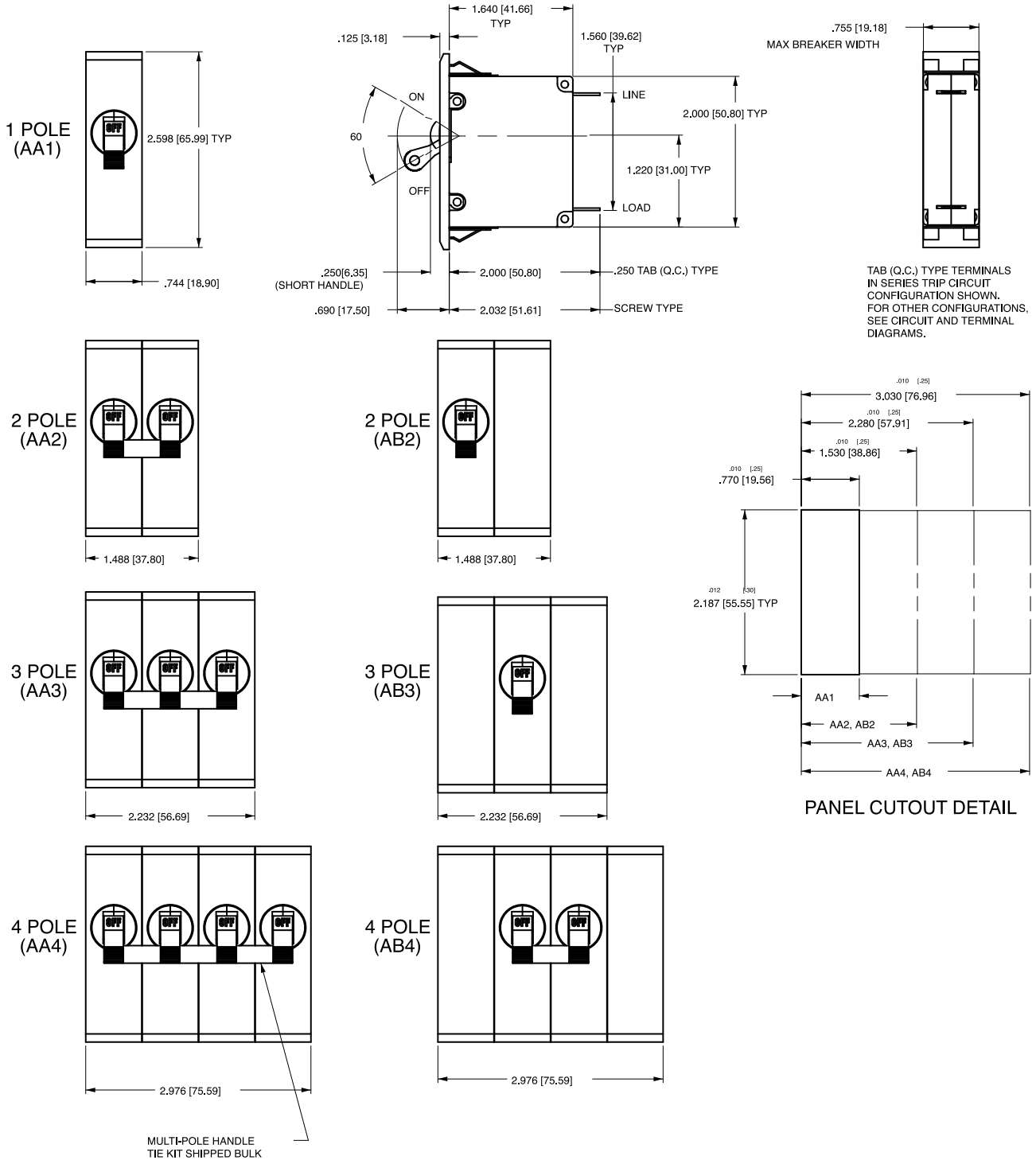

- Notes:
- 1 All dimensions are in inches [millimeters].
  - 2 Recommended panel thickness: .040 [1.02] to .100 [2.54].
  - 3 Tolerance  $\pm .020$  [.51] unless otherwise specified.

## Dimensional Specifications: in. [mm]

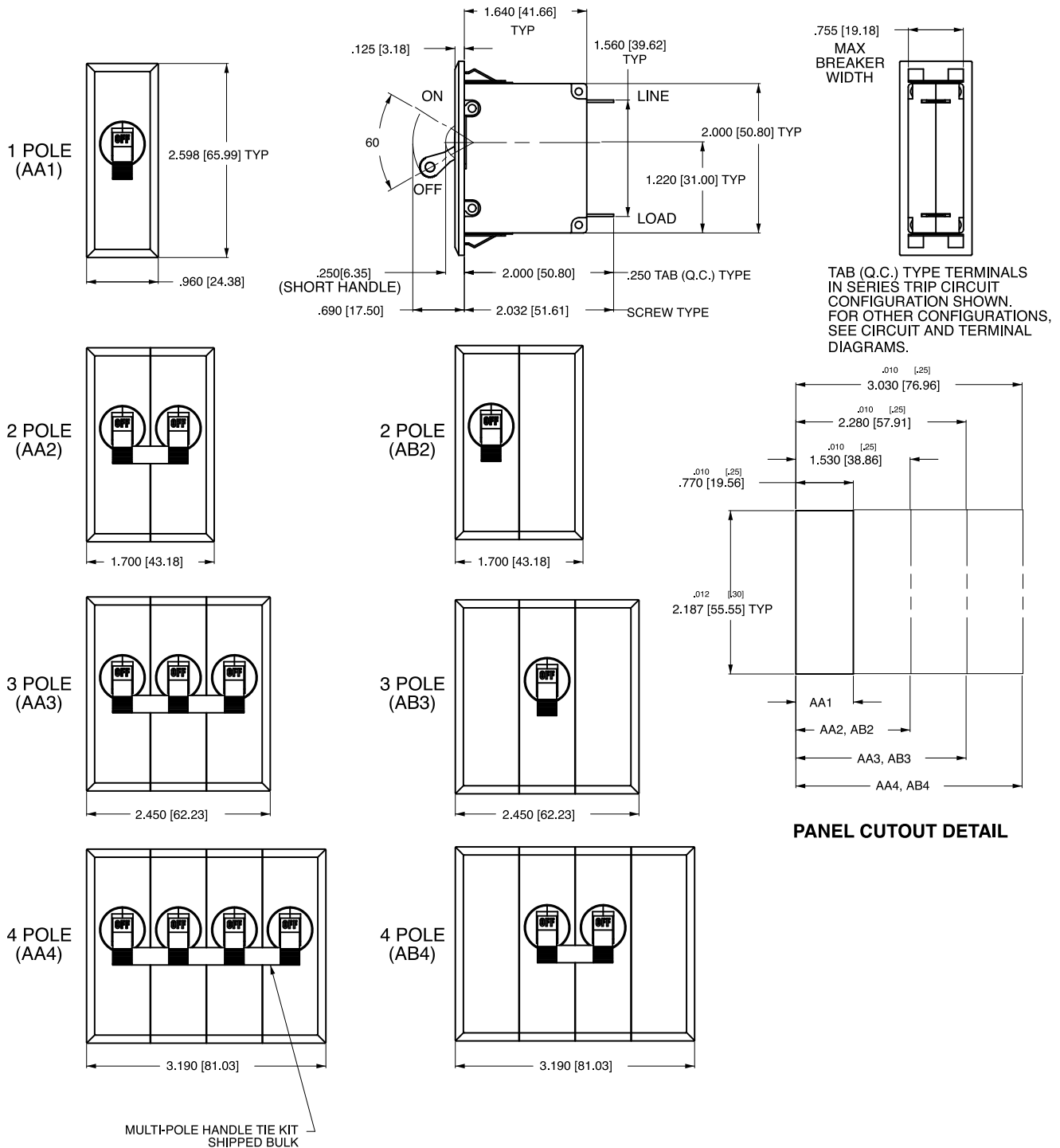

- Notes:  
 1 All dimensions are in inches [millimeters].  
 2 Recommended panel thickness: .040 [1.02] to .100 [2.54].  
 3 Tolerance  $\pm 0.020$  [.51] unless otherwise specified.



**A M 1 - B 0 - 10 - 450 - 1 0 1 - C**

1 Series    2 Actuator    3 Poles    4 Circuit    5 Aux/Alarm Switch    6 Frequency & Delay    7 Current Rating    8 Terminal    9 Actuator Color    10 Mounting/Barriers    11 Agency Approval

**1 SERIES**  
A

**2 ACTUATOR <sup>1</sup>**

M Sealed Toggle, one per unit

**3 POLES**

1 One  
2 Two  
3 Three

**4 CIRCUIT**

A <sup>2</sup> Switch Only (No Coil)	F <sup>3</sup> Relay Trip (Current)
B Series Trip (Current)	G <sup>3</sup> Relay Trip (Voltage)
C Series Trip (Voltage)	H <sup>3,4</sup> Dual Coil with Shunt Trip Voltage Coil
D <sup>3</sup> Shunt Trip (Current)	K <sup>3,4</sup> Dual Coil with Relay Trip Voltage Coil
E <sup>3</sup> Shunt Trip (Voltage)	

**5 AUXILIARY / ALARM SWITCH <sup>5</sup>**

0 without Aux Switch	5 S.P.S.T., 0.093 Q.C. Term. (Gold Contacts)
1 S.P.D.T., 0.093 Q.C. Term.	7 S.P.S.T., 0.110 Q.C. Term. (Gold Contacts)
2 S.P.D.T., 0.110 Q.C. Term.	8 S.P.S.T., 0.187 Q.C. Term.
4 S.P.D.T., 0.110 Q.C. Term. (Gold Contacts)	9 S.P.D.T., 0.187 Q.C. Term.

**6 FREQUENCY & DELAY**

03 DC 50/60Hz, Switch Only	30 DC, 50/60Hz Instantaneous
10 DC Instantaneous	31 DC, 50/60Hz Ultra Short
11 DC Ultra Short	32 DC, 50/60Hz Short
12 DC Short	34 DC, 50/60Hz Medium
14 DC Medium	36 DC, 50/60Hz Long
16 DC Long	42 <sup>7</sup> 50/60Hz Short, Hi-Inrush
20 50/60Hz Instantaneous	44 <sup>7</sup> 50/60Hz Medium, Hi-Inrush
21 50/60Hz Ultra Short	46 <sup>7</sup> 50/60Hz Long, Hi-Inrush
22 50/60Hz Short	52 <sup>7</sup> DC, Short, Hi-Inrush
24 50/60Hz Medium	54 <sup>7</sup> DC, Medium, Hi-Inrush
26 50/60Hz Long	56 <sup>7</sup> DC, Long, Hi-Inrush

**7 CURRENT RATING (AMPERES)**

CODE	AMPERES				
020	0.020	230	0.300	425	2.500
025	0.025	235	0.350	527	2.750
030	0.030	240	0.400	430	3.000
035	0.035	245	0.450	435	3.500
040	0.040	250	0.500	440	4.000
045	0.045	255	0.550	445	4.500
050	0.050	260	0.600	450	5.000
055	0.055	265	0.650	455	5.500
060	0.060	270	0.700	460	6.000
065	0.065	275	0.750	465	6.500
070	0.070	280	0.800	470	7.000
075	0.075	285	0.850	475	7.500
080	0.080	290	0.900	480	8.000
085	0.085	295	0.950	485	8.500
090	0.090	410	1.000	490	9.000
095	0.095	512	1.250	495	9.500
210	0.100	415	1.500	610	10.000
215	0.150	517	1.750	710	10.500
220	0.200	420	2.000	611	11.000
225	0.250	522	2.250	711	11.500

**OR VOLTAGE COIL (NORMAL RATED VOLTAGE) <sup>6</sup>**

CODE	AMPERES				
A06	6 DC	A32	32 DC	J12	12 AC
A12	12 DC	A48	48 DC	J18	18 AC
A18	18 DC	A65	65 DC	J24	24 AC
A24	24 DC	J06	6 AC	J48	48 AC
				J65	65 AC
				K20	120 AC
				L40	240 AC

**8 TERMINAL <sup>9</sup>**

1 <sup>10</sup> Push-On 0.250 Tab (Q.C.)	E Screw M4 (Bus Type)
2 Screw 8-32 with upturned lugs	F Screw M5 with upturned lugs & 30° bend
3 Screw 8-32 (Bus Type)	G Screw M5 (Bus Type) & 30° bend
4 Screw 10-32 with upturned lugs	H Screw M5 (Bus Type)
5 Screw 10-32 (Bus Type)	L <sup>12</sup> 0.250 Q.C./ Solder Lug
6 Screw 8-32 with upturned lugs & 30° bend	M M6 Threaded Stud
7 Screw 8-32 (Bus Type) & 30° bend	Q Push-In Stud
8 Screw 10-32 with upturned lugs & 30° bend	R Screw M4 with upturned lugs & 30° bend
9 Screw 10-32 (Bus Type) & 30° bend	T Screw M4 (Bus Type) & 30° bend
B Screw M5 with upturned lugs	P <sup>12</sup> Printed Circuit Board Terminals
C Screw M4 with upturned lugs	S Push-On 0.110 Tab (Q.C.)

**9 LEGEND PLATE**

0 No legend plate

**10 MOUNTING / BARRIERS**

MOUNTING STYLE	BARRIERS
1 Standard Hex Nut	no
A Standard Hex Nut (multipole only)	yes

**11 AGENCY APPROVAL**

C UL Recognized & CSA Accepted  
I UL Recognized STD 1077, UL Recognized 1500 (ignition protected), & CSA Accepted

Notes:

- Actuator Code M: Handle location as viewed from front of panel:  
2 pole - right pole    3 pole - center pole
- Switch Only circuits, rated up to 50 amps and 3 poles. Only available when tied to a protected pole. For .02 to 30 amps, select Current Code 630. For 35 - 50 amps, select Current Code 650.
- Available with terminal Codes 1, 2 and 3. Current Rating limited to 30 amps maximum.
- Consult factory for available Dual Coil options, as special catalog number is required. With Shunt construction, Dual Coils will trip instantaneously on line voltage. Dual coils require 30VA minimum power to trip and are rated for intermittent duty only.
- Auxiliary Switch available on Series Trip & Switch Only circuits, limited to 30 amps. On multi-pole breakers, one auxiliary switch is supplied, mounted in the extreme right pole.
- Voltage coils not rated for continuous duty. Available only with delay codes 10 and 20.
- Available with Circuit Codes B & D only. VDE Certified to 30 amps. UL Recognized, CSA Accepted & TUV Certified to 50 amps.
- UL Recognition and CSA Certification available on one and two pole breakers.
- Screw Terminals are recommended on ratings greater than 20 amps. Ratings over 30 amps are only available with Terminal Codes 5, 9, B, F, G, H, M and Q.
- Terminal Code 1: UL Recognition and CSA Certification up to 30 amps, but not recommended over 20 amps.
- Terminal Code L: available up to 30A.
- Single pole breakers with Terminal Code P (Printed Circuit Board) are available up to 50 amps, with Circuit Codes A, B and C. Two pole breakers with Terminal Code P (Printed Circuit Board) are available up to 40 amps with Circuit Codes A, B and C.

## Dimensional Specifications: in. [mm]

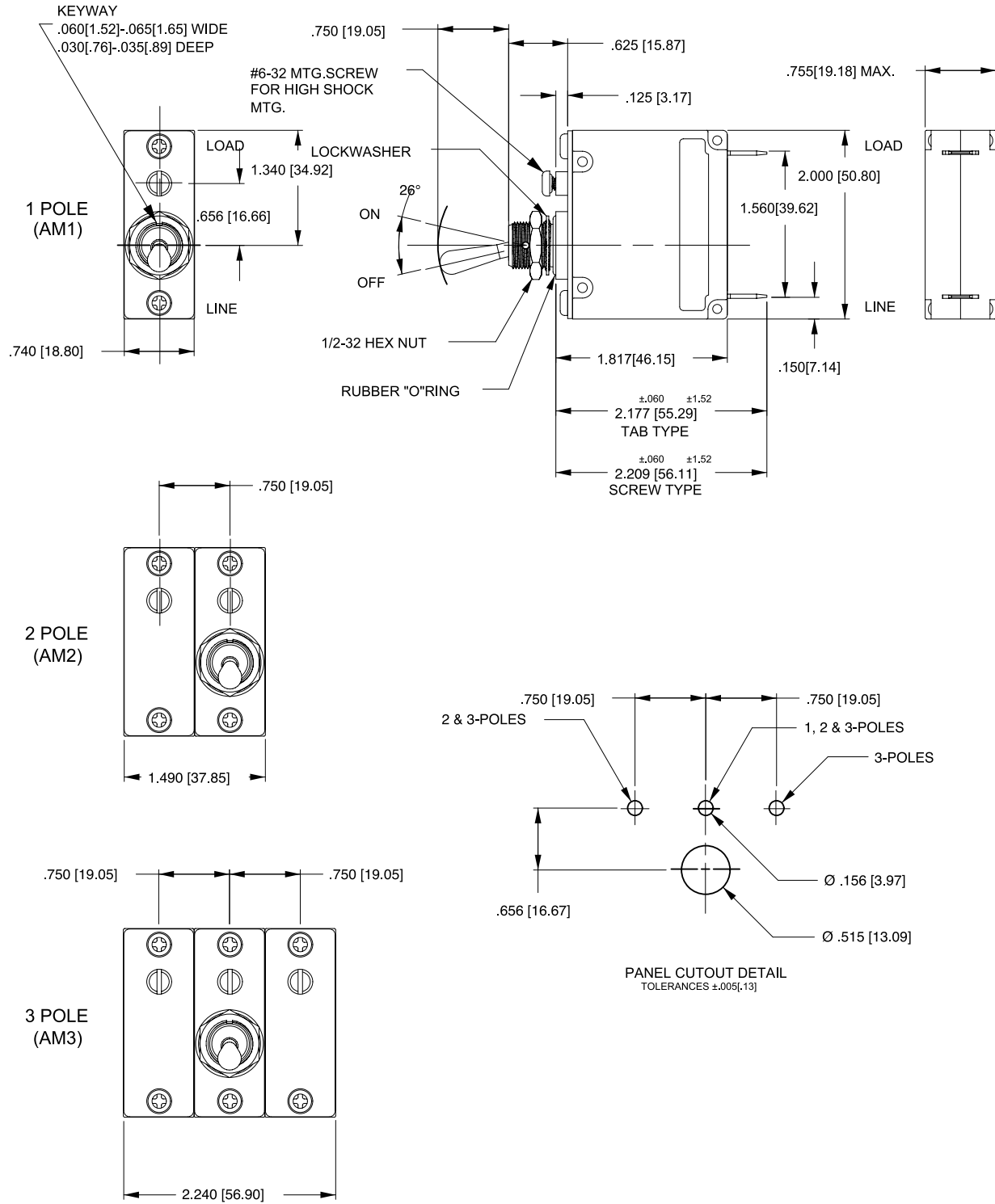

Notes:

- 1 All dimensions are in inches [millimeters].
- 2 Tolerance ±.020 [.51] unless otherwise specified.

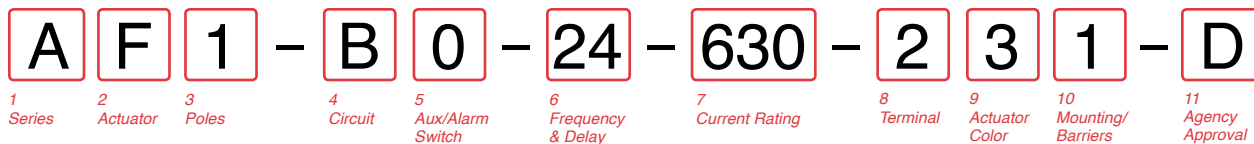

**1 SERIES**

**A**

**2 ACTUATOR 1**

**Two Color Visi-Rocker**

- C** Indicate ON, vertical legend
- D** Indicate ON, horizontal legend
- F** Indicate OFF, vertical legend
- G** Indicate OFF, horizontal legend
- H** Indicate OFF, no legend

**Push-To-Reset, Visi-Rocker**

- N** Indicate OFF, vertical legend
- O** Indicate OFF, horizontal legend
- P** Indicate OFF, no legend

**Single color**

- J** Vertical legend
- K** Horizontal legend
- L** No legend

**Push-To-Reset, Single color**

- R** Vertical legend
- U** Horizontal legend
- V** No legend

**ROCKER STYLE DESCRIPTIONS**

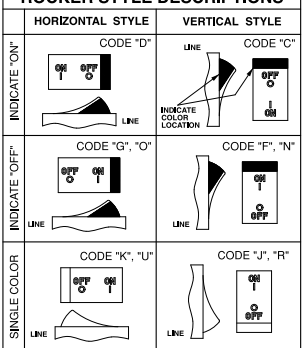

**3 POLES**

- 1** One                                      **2** Two                                      **3** Three

**4 CIRCUIT**

- A<sup>3</sup>** Switch Only (No Coil)                      **F<sup>4</sup>** Relay Trip (Current)
- B** Series Trip (Current)                      **G<sup>4</sup>** Relay Trip (Voltage)
- C** Series Trip (Voltage)                      **H<sup>4,5</sup>** Dual Coil with Shunt Trip Voltage Coil
- D<sup>4</sup>** Shunt Trip (Current)                      **K<sup>4,5</sup>** Dual Coil with Relay Trip Voltage Coil
- E<sup>4</sup>** Shunt Trip (Voltage)

**5 AUXILIARY / ALARM SWITCH 6,7**

- 0** without Aux Switch                      **5** S.P.S.T., 0.093 Q.C. Term. (Gold Contacts)
- 1** S.P.D.T., 0.093 Q.C. Term.                      **7** S.P.S.T., 0.110 Q.C. Term. (Gold Contacts)
- 2** S.P.D.T., 0.110 Q.C. Term.                      **8** S.P.S.T., 0.187 Q.C. Term. (Gold Contacts)
- 4** S.P.D.T., 0.110 Q.C. Term. (Gold Contacts)                      **9** S.P.D.T., 0.187 Q.C. Term. (Gold Contacts)

**6 FREQUENCY & DELAY**

- 03** DC 50/60Hz, Switch Only                      **30** DC, 50/60Hz Instantaneous
- 10** DC Instantaneous                      **31** DC, 50/60Hz Ultra Short
- 11** DC Ultra Short                      **32** DC, 50/60Hz Short
- 12** DC Short                      **34** DC, 50/60Hz Medium
- 14** DC Medium                      **36** DC, 50/60Hz Long
- 16** DC Long                      **42<sup>9</sup>** 50/60Hz Short, Hi-Inrush
- 20** 50/60Hz Instantaneous                      **44<sup>9</sup>** 50/60Hz Medium, Hi-Inrush
- 21** 50/60Hz Ultra Short                      **46<sup>9</sup>** 50/60Hz Long, Hi-Inrush
- 22** 50/60Hz Short                      **52<sup>9</sup>** DC, Short, Hi-Inrush
- 24** 50/60Hz Medium                      **54<sup>9</sup>** DC, Medium, Hi-Inrush
- 26** 50/60Hz Long                      **56<sup>9</sup>** DC, Long, Hi-Inrush

**Notes:**

- 1 Push-To-Reset actuators have OFF portion of rocker shrouded.
- 2 Multi-pole breakers have all breakers identical except when specifying Auxiliary switch and/or mixed poles, and have one rocker per breaker.
- 3 Switch Only circuits, rated up to 50 amps & 3 poles, are available only when tied to a protected pole (Circuit Code B, C, D or H). For .02 to 30 amps, select Current Code 630. For 35 - 50 amps, select Current Code 650.
- 4 Available with terminal Codes 1, 2 and 3. Current Rating limited to 30 amps maximum.
- 5 Consult factory for Dual Coil options, as special catalog number is required. With Shunt construction, Dual Coils will trip instantaneously on line voltage. Dual coils require 30VA minimum power to trip and are rated for intermittent duty only.
- 6 Auxiliary Switch breakers with Series Trip & Switch Only circuits: ≤ 30A, are supplied with standard half shells. 30-50A are supplied with extended boat (B-Style) half shells.
- 7 On multi-pole breakers, one auxiliary switch is supplied, mounted in the extreme right pole.
- 8 Separate pole type voltage coils not rated for continuous duty. Available only with delay codes 10 & 20.
- 9 Available with Circuit Codes B & D only. VDE Certified to 30 amps. UL Recognized, CSA Accepted & TUV Certified to 50 amps.
- 10 Series Trip current ratings: VDE Certification available with single pole breakers with DC Delay only. UL Recognition & CSA Accepted available in one and two pole breakers.
- 11 Screw Terminals are recommended on ratings greater than 20 amps. Ratings over 30 amps are only available with Terminal Codes 5, 9, G, H, M and Q.
- 12 Terminal Code 1: VDE Certification up to 25 amps and UL Recognition and CSA Accepted up to 30 amps, but not recommended over 20 amps.
- 13 Terminal Codes 3, 5 E & H (Bus Type) with VDE, are supplied with Lock Washers; Terminal Code M (M6 Threaded Stud) with VDE is supplied with Lock and Flat Washers. These breakers are only VDE Certified when the washers are used.
- 14 VDE Cert. available up to 12 amps. UL Rec. & CSA Accepted available up to 30 amps.
- 15 Single pole breakers with Terminal Code P (Printed Circuit Board) are available up to 30 amps with VDE Certification and 50 amps with UL Recognition and CSA Accepted, with Circuit Codes A, B & C. Two pole breakers with Terminal Code P (Printed Circuit Board) are available up to 40 amps with UL Recognition and CSA Certification with Circuit Codes A, B and C.
- 16 Terminal Code Q not available with VDE.
- 17 Terminal Code S used on voltage coil circuit constructions only.
- 18 Color shown is visi and legend with remainder of rocker black.
- 19 Dual = ON-OFF/I-O legend with actuator. None = no legend on actuator
- 20 Legend on Push-to-reset bezel/shroud is white with single color actuator codes R, & U. Legend on Push-to-reset bezel/shroud matches Visi-color of rocker with actuator codes N & O. Rockerguard available with actuator codes C through L.

**7 CURRENT RATING (AMPERES)**

CODE	AMPERES	225	230	240	245	250	255	260	265	270	275	280	285	290	295	410	415	420	430	440	445	450	455	460	465	470	475	480	485	490	495	611	612	613	614	615	616	617	618	620	622	624	625	630	635	640	645	650									
020	0.020	0.250	0.300	0.400	0.450	0.500	0.550	0.600	0.650	0.700	0.750	0.800	0.850	0.900	0.950	1.000	1.250	1.500	1.750	2.000	2.250	2.750	3.000	3.500	4.000	4.500	5.000	5.500	6.000	6.500	7.000	7.500	8.000	8.500	9.000	9.500	10.000	10.500	11.000	11.500	12.000	12.500	13.000	14.000	15.000	16.000	17.000	18.000	20.000	22.000	24.000	25.000	30.000	35.000	40.000	45.000	50.000

**OR VOLTAGE COIL (NORMAL RATED VOLTAGE) <sup>8</sup>**

CODE	AMPERES	A06	A12	A18	A24	A32	A48	A65	J06	J12	J18	J24	J48	J65	K20	L40
		6 DC	12 DC	18 DC	24 DC	32 DC	48 DC	65 DC	6 AC	12 AC	18 AC	24 AC	48 AC	65 AC	120 AC	240 AC

**8 TERMINAL <sup>11</sup>**

- 1** <sup>12</sup> Push-On 0.250 Tab (Q.C.)
- 2** Screw 8-32 with upturned lugs
- 3** Screw 8-32 (Bus Type)
- 4** Screw 10-32 with upturned lugs
- 5** <sup>13</sup> Screw 10-32 (Bus Type)
- 6** Screw 8-32 with upturned lugs & 30° bend
- 7** Screw 8-32 (Bus Type) & 30° bend
- 8** Screw 10-32 with upturned lugs & 30° bend
- 9** Screw 10-32 (Bus Type) & 30° bend
- B** Screw M5 with upturned lugs
- C** Screw M4 with upturned lugs
- E** <sup>13</sup> Screw M4 (Bus Type)
- F** Screw M5 with upturned lugs & 30° bend
- G** Screw M5 (Bus Type) & 30° bend
- H** <sup>13</sup> Screw M5 (Bus Type)
- L** <sup>14</sup> 0.250 Q.C./ Solder Lug
- M** <sup>13</sup> M6 Threaded Stud
- P** <sup>15</sup> Printed Circuit Board Terminals
- Q** <sup>16</sup> Push-In Stud
- R** Screw M4 with upturned lugs & 30° bend
- S** <sup>17</sup> Push-On 0.110 Tab (Q.C.) & 30° bend
- T** Screw M4 (Bus Type) & 30° bend

**9 ACTUATOR COLOR & LEGEND**

Actuator or Visi-Color <sup>12</sup>	Marking:			Marking Color		
	I-O	ON-OFF	Dual <sup>12</sup>	Single Color	Visi-Rocker	
White	A	B	1	Black	White	
Black	C	D	2	White	n/a	
Red	F	G	3	White	Red	
Green	H	J	4	White	Green	
Blue	K	L	5	White	Blue	
Yellow	M	N	6	Black	Yellow	
Gray	P	Q	7	Black	Gray	
Orange	R	S	8	Black	Orange	

**10 MOUNTING / BARRIERS <sup>20</sup>**

	STANDARD ROCKER BEZEL	BARRIERS
<b>1</b>	<b>Threaded Insert, 2 per pole</b> 6-32 x 0.195 inches	no
<b>A</b>	6-32 X 0.195 inches (multi-pole units only)	yes
<b>2</b>	ISO M3 x 5mm	no
<b>B</b>	ISO M3 x 5mm (multi-pole units only)	yes
	<b>ROCKERGUARD &amp; PUSH-TO-RESET BEZEL</b>	
<b>3</b>	<b>Threaded Insert, 2 per pole</b> 6-32 x 0.195 inches	no
<b>C</b>	6-32 x 0.195 inches (multi-pole units only)	yes
<b>D</b>	ISO M3 x 5mm	no
<b>D</b>	ISO M3 x 5mm (multi-pole units only)	yes
<b>8</b>	<b>FRONT PANEL SNAP-IN BRACKET, 0.744" [18.90mm] wide bezel</b> without Rockerguard (single pole units only)	no
<b>H</b>	with Rockerguard (single pole units only)	no
<b>9</b>	<b>FRONT PANEL SNAP-IN BRACKET, 0.96" [24.48mm] wide bezel</b> without Rockerguard (single pole units only)	no
<b>J</b>	with Rockerguard (single pole units only)	no

**11 AGENCY APPROVAL**

- C** UL Recognized & CSA Accepted
- D** VDE Certified, UL Recognized & CSA Accepted
- E** TUV Certified, UL Recognized & CSA Accepted
- I** UL Recognized STD 1077, UL Recognized 1500 (ignition protected), & CSA Accepted

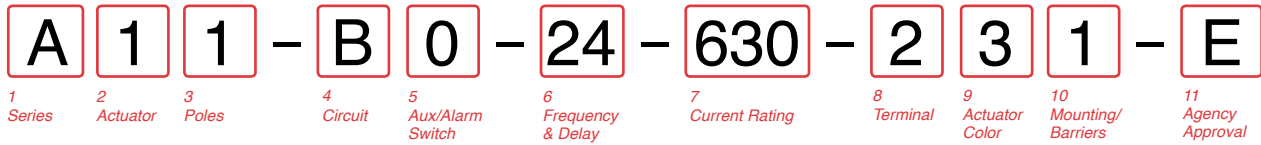

**1 SERIES**  
A

**2 ACTUATOR 1**

- Two Color Visi-Rocker**
- 1 Indicate OFF, vertical legend
- 2 Indicate OFF, horizontal legend
- Single color**
- 3 Vertical legend
- 4 Horizontal legend
- Push-To-Reset, Visi-Rocker**
- 5 Indicate OFF, vertical legend
- 6 Indicate OFF, horizontal legend
- Push-To-Reset, Single color**
- 7 Vertical legend
- 8 Horizontal legend

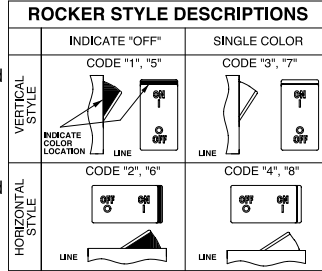

**3 POLES 2**

- 1 One
- 2 Two
- 3 Three

**4 CIRCUIT**

- A<sup>3</sup> Switch Only (No Coil)
- B Series Trip (Current)
- C Series Trip (Voltage)
- D<sup>4</sup> Shunt Trip (Current)
- E<sup>4</sup> Shunt Trip (Voltage)
- F<sup>4</sup> Relay Trip (Current)
- G<sup>4</sup> Relay Trip (Voltage)
- H<sup>4,5</sup> Dual Coil with Shunt Trip Voltage Coil
- K<sup>4,5</sup> Dual Coil with Relay Trip Voltage Coil

**5 AUXILIARY / ALARM SWITCH 6,7**

- 0 without Aux Switch
- 1 S.P.D.T., 0.093 Q.C. Term.
- 2 S.P.D.T., 0.110 Q.C. Term.
- 4 S.P.D.T., 0.110 Q.C. Term. (Gold Contacts)
- 5 S.P.S.T., 0.093 Q.C. Term. (Gold Contacts)
- 7 S.P.S.T., 0.110 Q.C. Term. (Gold Contacts)
- 8 S.P.S.T., 0.187 Q.C. Term.
- 9 S.P.D.T., 0.187 Q.C. Term.

**6 FREQUENCY & DELAY**

- 03 DC 50/60Hz, Switch Only
- 10<sup>6</sup> DC Instantaneous
- 11 DC Ultra Short
- 12 DC Short
- 14 DC Medium
- 16 DC Long
- 20<sup>6</sup> 50/60Hz Instantaneous
- 21 50/60Hz Ultra Short
- 22 50/60Hz Short
- 24 50/60Hz Medium
- 26 50/60Hz Long
- 30 DC, 50/60Hz Instantaneous
- 31 DC, 50/60Hz Ultra Short
- 32 DC, 50/60Hz Short
- 34 DC, 50/60Hz Medium
- 36 DC, 50/60Hz Long
- 42<sup>9</sup> 50/60Hz Short, Hi-Inrush
- 44<sup>9</sup> 50/60Hz Medium, Hi-Inrush
- 46<sup>9</sup> 50/60Hz Long, Hi-Inrush
- 52<sup>9</sup> DC, Short, Hi-Inrush
- 54<sup>9</sup> DC, Medium, Hi-Inrush
- 56 DC, Long, Hi-Inrush

**7 CURRENT RATING (AMPERES)**

CODE	AMPERES						
020	0.020	225	0.250	420	2.000	611	11.000
025	0.025	230	0.300	522	2.250	711	11.500
030	0.030	235	0.350	527	2.750	612	12.000
035	0.035	240	0.400	430	3.000	712	12.500
040	0.040	245	0.450	435	3.500	613	13.000
045	0.045	250	0.500	440	4.000	614	14.000
050	0.050	255	0.550	445	4.500	615	15.000
055	0.055	260	0.600	450	5.000	616	16.000
060	0.060	265	0.650	455	5.500	617	17.000
065	0.065	270	0.700	460	6.000	618	18.000
070	0.070	275	0.750	465	6.500	620	20.000
075	0.075	280	0.800	470	7.000	622	22.000
080	0.080	285	0.850	475	7.500	624	24.000
085	0.085	290	0.900	480	8.000	625	25.000
090	0.090	295	0.950	485	8.500	630	30.000
095	0.095	410	1.000	490	9.000	635	35.000
210	0.100	512	1.250	495	9.500	640	40.000
215	0.150	415	1.500	610	10.000	645	45.000
220	0.200	517	1.750	710	10.500	650	50.000

**OR VOLTAGE COIL (NORMAL RATED VOLTAGE) 8**

CODE	AMPERES				
A06	6 DC	A32	32 DC	J12	12 AC
A12	12 DC	A48	48 DC	J18	18 AC
A18	18 DC	A65	65 DC	J24	24 AC
A24	24 DC	J06	6 AC	J48	48 AC
				J65	65 AC
				K20	120 AC
				L40	240 AC

**8 TERMINAL 11**

- 1<sup>12</sup> Push-On 0.250 Tab (Q.C.)
- 2 Screw 8-32 with upturned lugs
- 3<sup>13</sup> Screw 8-32 (Bus Type)
- 4 Screw 10-32 with upturned lugs
- 5<sup>13</sup> Screw 10-32 (Bus Type)
- 6 Screw 8-32 with upturned lugs & 30° bend
- 7 Screw 8-32 (Bus Type) & 30° bend
- 8 Screw 10-32 with upturned lugs & 30° bend
- 9 Screw 10-32 (Bus Type) & 30° bend
- B Screw M5 with upturned lugs
- C Screw M4 with upturned lugs
- E<sup>13</sup> Screw M4 (Bus Type)
- F Screw M5 with upturned lugs & 30° bend
- G Screw M5 (Bus Type) & 30° bend
- H<sup>13</sup> Screw M5 (Bus Type)
- L<sup>14</sup> 0.250 Q.C./ Solder Lug
- M<sup>13</sup> M6 Threaded Stud
- P<sup>15</sup> Printed Circuit Board Terminals
- Q Push-In Stud
- R Screw M4 with upturned lugs & 30° bend
- S<sup>16</sup> Push-On 0.110 Tab (Q.C.) & 30° bend
- T Screw M4 (Bus Type) & 30° bend

**9 ACTUATOR COLOR & LEGEND**

Actuator or Visi-Color <sup>17</sup>	Marking:		Marking Color	
	ON-OFF	Dual <sup>17</sup>	Single Color	Visi-Rocker
White	B	1	Black	White
Black	D	2	White	n/a
Red	G	3	White	Red
Green	J	4	White	Green
Blue	L	5	White	Blue
Yellow	N	6	Black	Yellow
Gray	Q	7	Black	Gray
Orange	S	8	Black	Orange

**10 MOUNTING / BARRIERS 18**

	STANDARD ROCKER BEZEL Threaded Insert, 2 per pole	FLAT ROCKER ACTUATOR	BARRIERS
1	6-32 x 0.195 inches		no
A	6-32 X 0.195 inches (multi-pole units only)		yes
2	ISO M3 x 5mm		no
B	ISO M3 x 5mm (multi-pole units only)		yes
	RECESSED OFF SIDE ROCKER ACTUATOR <sup>19</sup>		
5	6-32 x 0.195 inches		no
E	6-32 x 0.195 inches (multi-pole units only)		yes
6	ISO M3 x 5mm		no
F	ISO M3 x 5mm (multi-pole units only)		yes
	PUSH-TO-RESET BEZEL, Threaded Insert, 2 per pole		
3	6-32 x 0.195 inches		no
C	6-32 x 0.195 inches (multi-pole units only)		yes
4	ISO M3 x 5mm		no
D	ISO M3 x 5mm (multi-pole units only)		yes

**11 AGENCY APPROVAL**

- C UL Recognized & CSA Accepted
- E TUV Certified, UL Recognized & CSA Accepted
- I UL Recognized STD 1077, UL Recognized 1500 (ignition protected), & CSA Accepted

Notes:

- 1 Push-To-Reset actuators have OFF portion of rocker shrouded.
- 2 Multi-pole breakers have all breakers identical except when specifying Auxiliary switch and/or mixed poles, and have one rocker per breaker.
- 3 Switch Only circuits, rated up to 50 amps & 3 poles. Only available when tied to a protected pole. For .02 to 30 amps, select Current Code 630. For 35 - 50 amps, select Current Code 650.
- 4 Available with terminal Codes 1, 2 and 3. Current Rating limited to 30 amps maximum.
- 5 Consult factory for Dual Coil options, as special catalog number is required. With Shunt construction, Dual Coils will trip instantaneously on line voltage. Dual coils require 30VA minimum power to trip and are rated for intermittent duty only.
- 6 Auxiliary Switch breakers with Series Trip & Switch Only circuits: ≤ 30A, are supplied with standard half shells. 30-50A are supplied with extended boat (B-Style) half shells.
- 7 On multi-pole breakers, one auxiliary switch is supplied, mounted in the extreme right pole.
- 8 Separate pole type voltage coils not rated for continuous duty. Available only with delay codes 10 & 20.
- 9 Available with Circuit Codes B & D only. UL Recognized, CSA Accepted & TUV Certified to 50 amps.
- 10 UL Recognition, CSA Acceptance & TUV Certification available in one and two pole breakers.
- 11 Screw Terminals are recommended on ratings greater than 20 amps. Ratings over 30 amps are only available with Terminal Codes 5, 9, G, H, M and Q.
- 12 Terminal Code 1: Available up to 30 amps, but not recommended over 20 amps.
- 13 Terminal Codes 3, 5 E & H (Bus Type) with TUV, are supplied with Lock Washers; Terminal Code M (M6 Threaded Stud) with TUV is supplied with Lock and Flat Washers. These breakers are only TUV Certified when the washers are used.
- 14 TUV Cert. available up to 12 amps. UL Rec. & CSA Accepted available up to 30 amps.
- 15 Single pole breakers with Terminal Code P (Printed Circuit Board) are available up to 50 amps with UL Recognition, CSA Accepted & TUV Certification, with Circuit Codes A, B and C. Two pole breakers with Terminal Code P (Printed Circuit Board) are available up to 40 amps with UL Recognition and CSA Accepted with Circuit Codes A, B and C.
- 16 Terminal Code S used on voltage coil circuit constructions only.
- 17 Color shown is visi and legend with remainder of rocker black, Dual = ON-OFF/I-O legend.
- 18 Legend on Push-to-reset bezel/shroud is white with single color actuator codes 7 & 8. Legend on Push-To-Reset bezel/shroud matches Visi-Color of rocker with actuator codes 5 & 6.
- 19 Recessed "off-side" available with actuator codes 1, 2, 3 & 4. Legends on rocker are available in ink stamping only.









## Circuit & Terminal Diagrams: in. [mm]

CIRCUIT BREAKER PROFILE	CIRCUIT SCHEMATIC		CIRCUIT CODE	AUX. SWITCH CODE	CIRCUIT SCHEMATIC		CIRCUIT CODE	AUX. SWITCH CODE
	ANSI	IEC			ANSI	IEC		
<b>2 TERMINALS</b> 	<b>SWITCH ONLY (NO COIL)</b> LINE LOAD LINE (NETZ) LOAD (LAST)		A	0	<b>SERIES TRIP</b> LINE LOAD LINE (NETZ) (3) LOAD (LAST)		B C	0
<b>5 TERMINALS</b> 	<b>SWITCH ONLY (NO COIL) WITH AUXILIARY SWITCH (4)</b> LINE LOAD LINE (NETZ) LOAD (LAST)		A	1 2 3 4	<b>SERIES TRIP WITH AUXILIARY SWITCH (4)</b> LINE LOAD LINE (NETZ) (3) LOAD (LAST)		B C	1 2 3 4
<b>3 TERMINALS</b> 	<b>SHUNT TRIP</b> LINE LOAD LINE (NETZ) (3) SHUNT (NEBENSCHLUSS) LOAD (LAST)		D E	0	<b>DUAL COIL; SERIES TRIP CURRENT COIL, SHUNT TRIP VOLTAGE COIL</b> LINE LOAD LINE (NETZ) LOAD (LAST)		H	0
<b>4 TERMINALS</b> 	<b>RELAY TRIP</b> LINE LOAD RELAY RELAY (RELAIS) LINE (NETZ) (3) RELAY (RELAIS) LOAD (LAST)		F G	0	<b>DUAL COIL; SERIES TRIP CURRENT COIL, RELAY TRIP VOLTAGE COIL</b> LINE LOAD RELAY RELAY (RELAIS) LINE (NETZ) RELAY (RELAIS) LOAD (LAST)		K	0

TERMINAL DESCRIPTION		DEPTH BEHIND PANEL
MAIN	TAB (Q.C.)	2.370 [60.20]
	SCREW TYPE	2.402 [61.01]
SHUNT, RELAY & DUAL COIL	TAB (Q.C.)	2.577 [65.46]
	SCREW #8-32 W/UPTURNED LUGS	2.734 [69.44]
AUX. SWITCH*	.093 TAB (Q.C.)	2.465 [62.61]
	.110 TAB (Q.C.)	2.559 [65.00]
	SOLDER TYPE	2.340 [59.44]

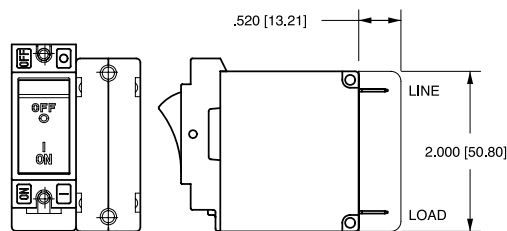

\* AVAILABLE ON SERIES TRIP AND SWITCH ONLY CIRCUITS. WHEN CALLED FOR ON MULTI-POLE UNITS, ONLY ONE AUX. SWITCH IS NORMALLY SUPPLIED, AS VIEWED IN MULTI-POLE IDENTIFICATION SCHEME.

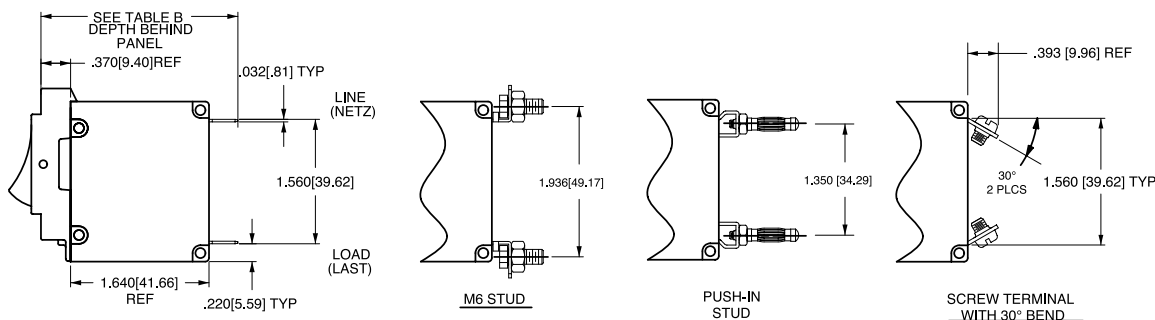

- Notes:
- All dimensions are in inches [millimeters].
  - Tolerance  $\pm .020$  [.51] unless otherwise specified.
  - Schematic shown represents current trip circuit.
  - Circuits shown for >30 amps / VDE.

## Dimensional Specifications: in. [mm]

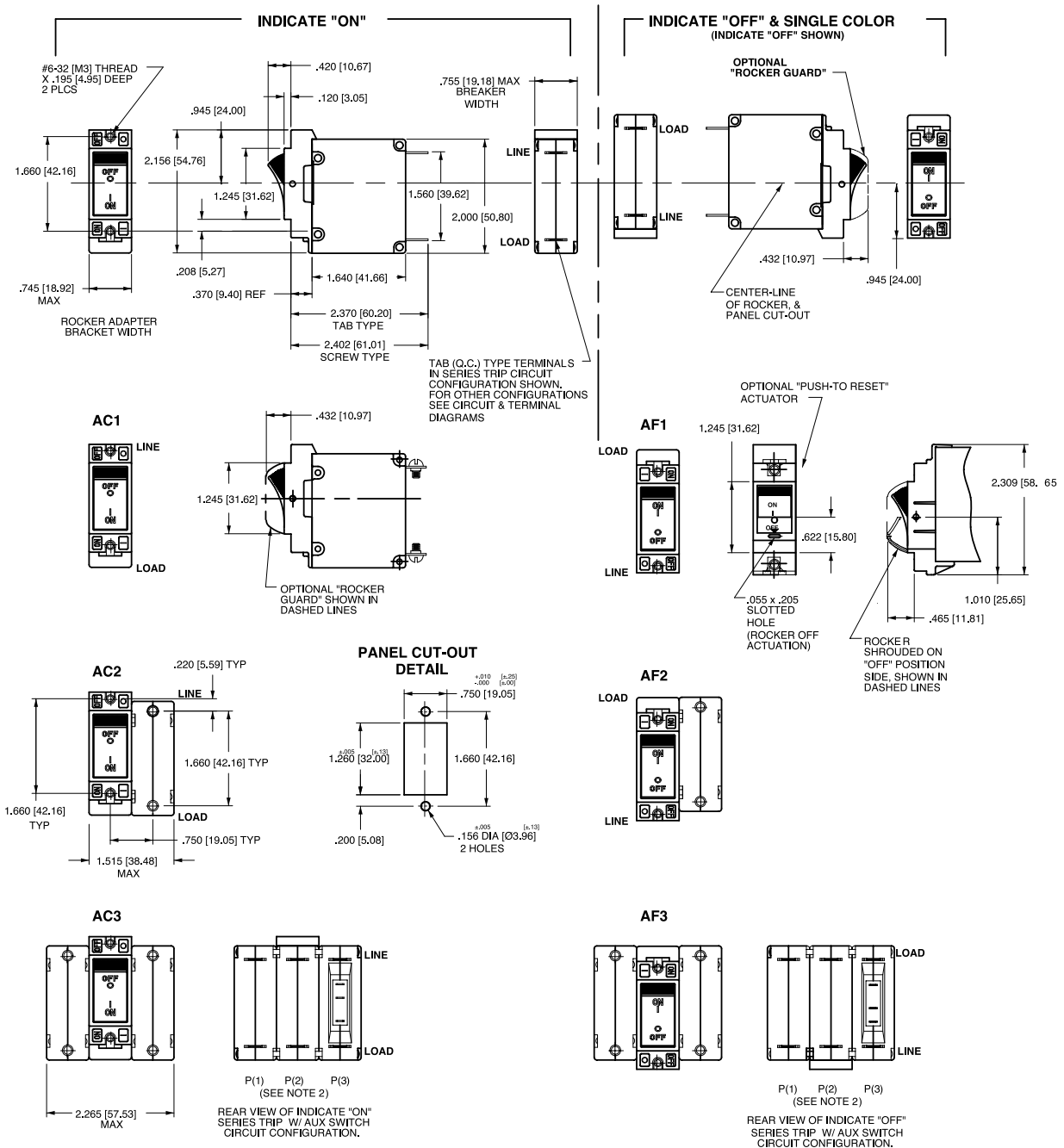

**Notes:**

- 1 Dimensions apply to all variations shown. Notice that circuit breaker line & load terminal orientation on indicate OFF is opposite of indicate ON.
- 2 For pole orientation with horizontal legend, rotate front view clockwise 90°.
- 3 All dimensions are in inches [millimeters].
- 4 Tolerance  $\pm 0.20$  [.51] unless otherwise specified.

## Dimensional Specifications: in. [mm]

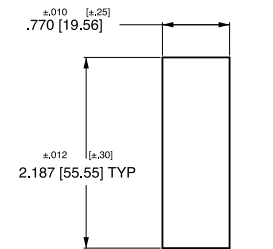
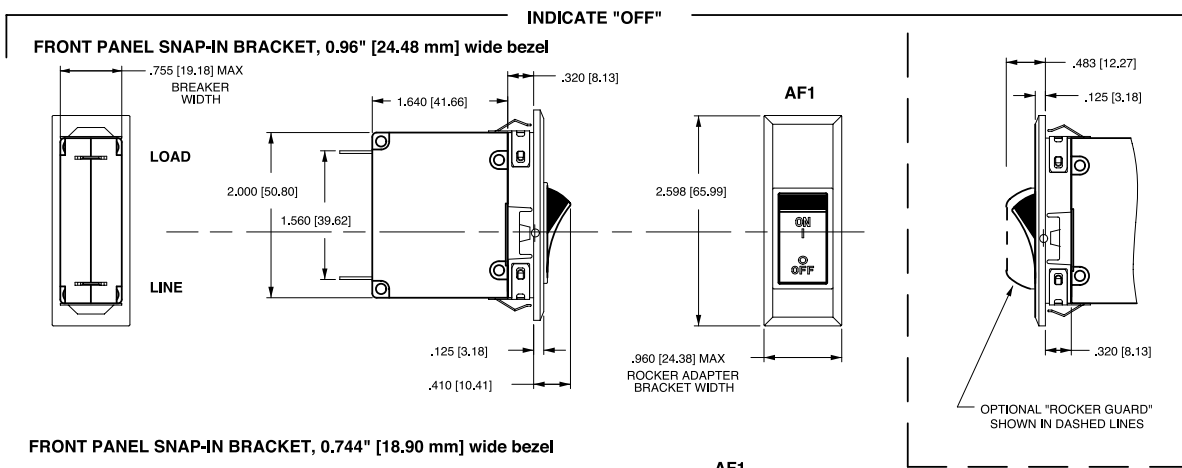
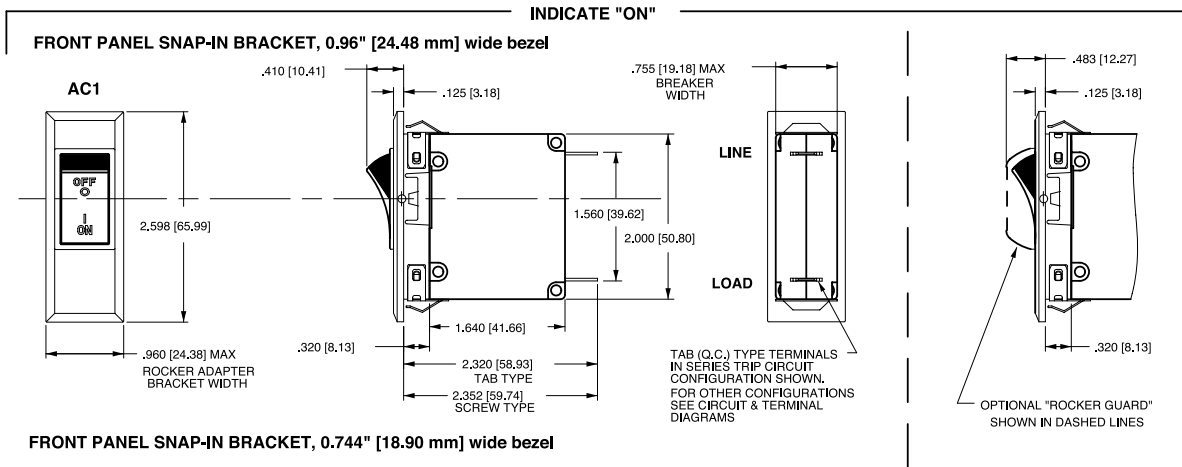

- Notes:
- 1 Dimensions apply to all variations shown. Notice that circuit breaker line & load terminal
  - 2 For pole orientation with horizontal legend, rotate front view clockwise 90°. Orientation on indicate "OFF" is opposite of indicate "ON"
  - 3 Recommended panel thickness: .040 [1.02] to .100 [2.54]
  - 4 All dimensions are in Inches [millimeters].
  - 5 Tolerance  $\pm 0.020$  [1.51] unless otherwise specified.

## Dimensional Specifications: in. [mm]

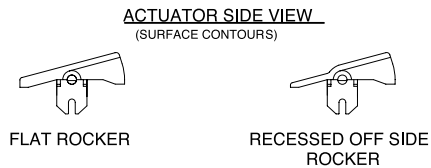
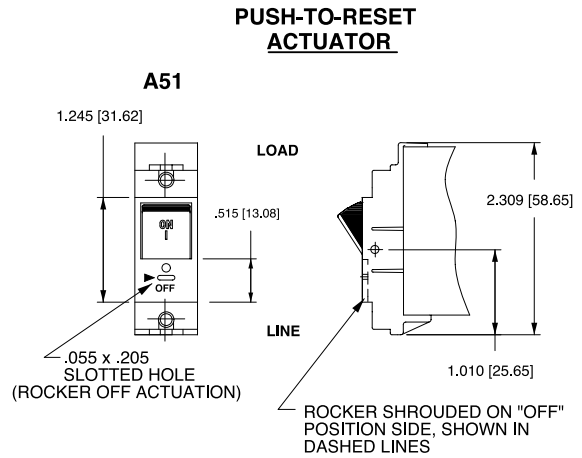
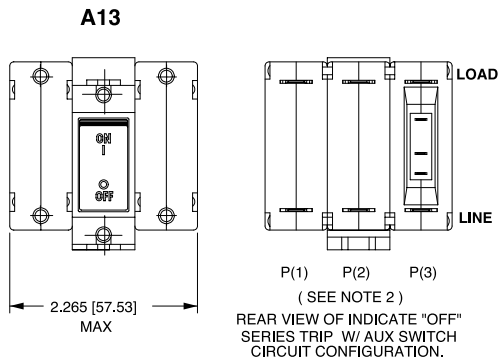
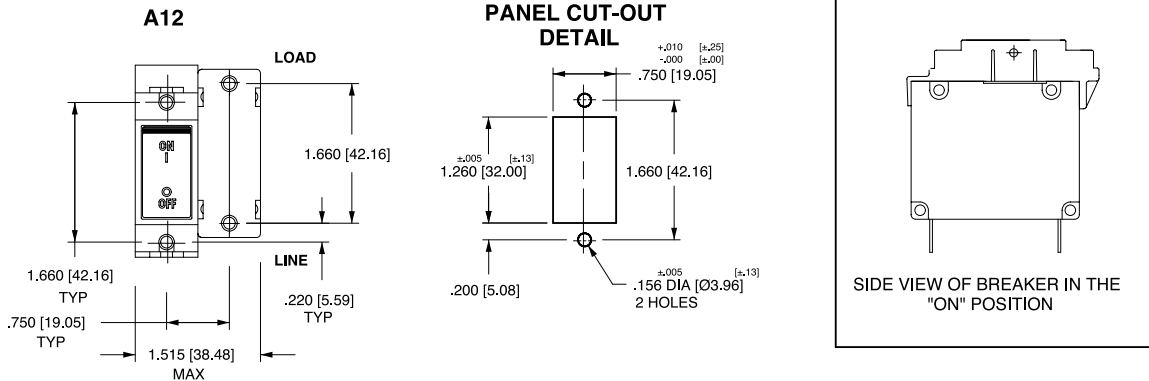
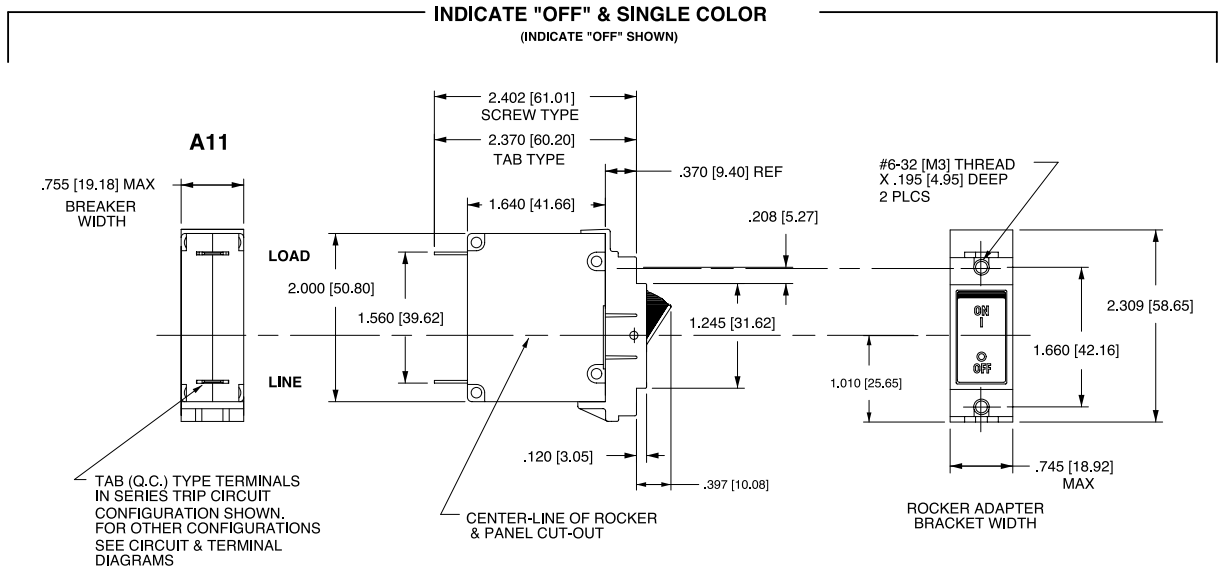

- Notes:
- 1 All dimensions are in inches [millimeters].
  - 2 For pole orientation with horizontal legend, rotate front view clockwise 90°.
  - 3 Tolerance ± 0.20 [.51] unless otherwise specified.

## Dimensional Specifications: in. [mm]

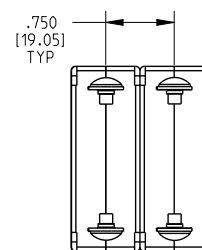
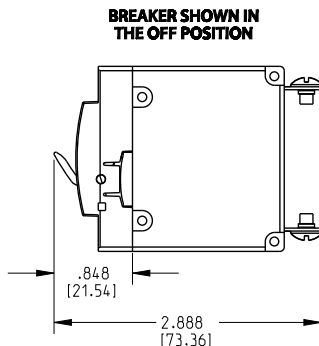
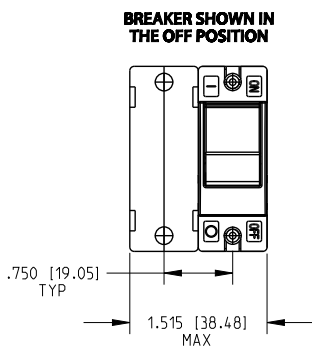
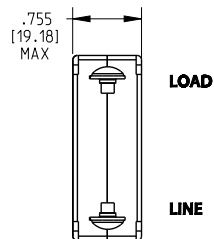
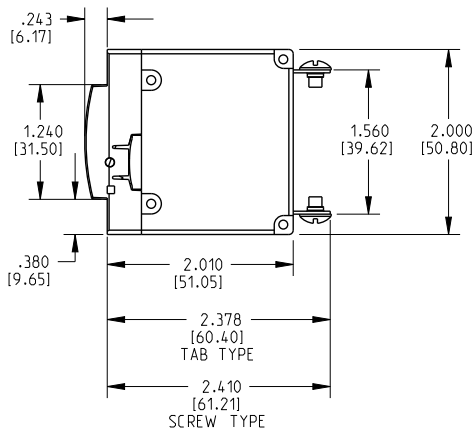
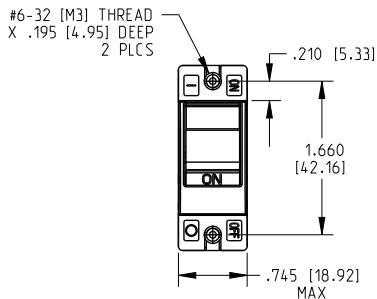

### PANEL CUT-OUT DETAIL

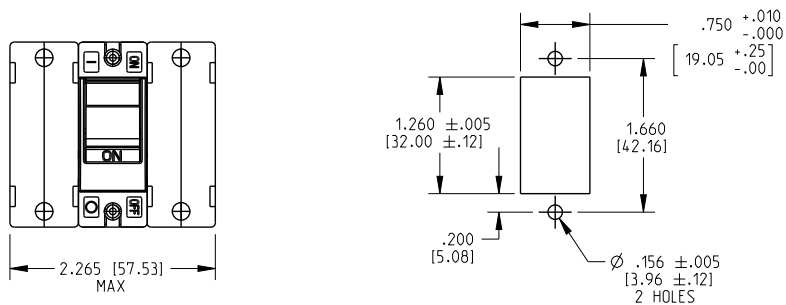

- Notes:
- 1 All dimensions are in inches [millimeters].
  - 2 Tolerance ± 0.20 [51] unless otherwise specified





## Authorized Sales Representatives and Distributors

Click on a region of the map below to find your local representatives and distributors or visit [www.carlingtech.com/findarep](http://www.carlingtech.com/findarep).



## About Carling

Founded in 1920, Carling Technologies is a leading manufacturer of electrical and electronic switches and assemblies, circuit breakers, electronic controls, power distribution units, and multiplexed power distribution systems. With four ISO registered manufacturing facilities and technical sales offices worldwide, Carling Technologies Sales, Service and Engineering teams do much more than manufacture electrical components, they engineer powerful solutions! To learn more about Carling please visit [www.carlingtech.com/company-profile](http://www.carlingtech.com/company-profile).

To view all of Carling's environmental, quality, health & safety certifications please visit [www.carlingtech.com/environmental-certifications](http://www.carlingtech.com/environmental-certifications)

## **Worldwide Headquarters**

Carling Technologies, Inc.  
60 Johnson Avenue, Plainville, CT 06062  
**Phone:** 860.793.9281 **Fax:** 860.793.9231  
**Email:** sales@carlingtech.com

**Northern Region Sales Office:** nrsm@carlingtech.com  
**Southeast Region Sales Office:** sersm@carlingtech.com  
**Midwest Region Sales Office:** mrrsm@carlingtech.com  
**West Region Sales Office:** wrsm@carlingtech.com  
**Latin America Sales Office:** larsm@carlingtech.com

## **Asia-Pacific Headquarters**

Carling Technologies, Asia-Pacific Ltd.,  
Suite 1607, 16/F Tower 2, The Gateway,  
Harbour City, 25 Canton Road,  
Tsimshatsui, Kowloon, Hong Kong  
**Phone:** Int + 852-2737-2277 **Fax:** Int + 852-2736-9332  
**Email:** sales@carlingtech.com.hk

**Shenzhen, China:** shenzhen@carlingtech.com  
**Shanghai, China:** shanghai@carlingtech.com  
**Pune, India:** india@carlingtech.com  
**Kaohsiung, Taiwan:** taiwan@carlingtech.com  
**Yokohama, Japan:** japan@carlingtech.com

## **Europe | Middle East | Africa Headquarters**

Carling Technologies LTD  
4 Airport Business Park, Exeter Airport,  
Clyst Honiton, Exeter, Devon, EX5 2UL, UK  
**Phone:** Int + 44 1392.364422 **Fax:** Int + 44 1392.364477  
**Email:** ltd.sales@carlingtech.com

**Germany:** gmbh@carlingtech.com  
**France:** sas@carlingtech.com



**Carling Technologies®**

Innovative Designs. Powerful Solutions.