

# ACCESSORIES

Belt/Pocket clip, Wall-suspension element, Wall-mounting brackets



Suitable for OKW cases:

- DATEC-POCKET-BOX L, M and S
- SHELL-TYPE CASE 85 and 110
- FLAT-PACK CASE N 100

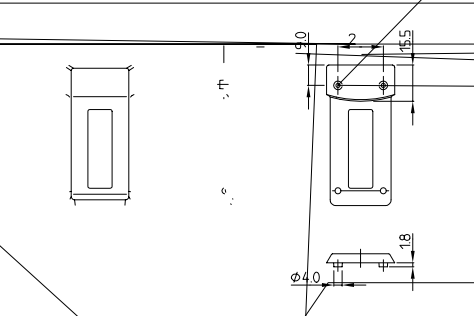

Article / Version		Supply
Clip, off-white	RAL 9002	1 clip, 1 mounting kit of 2 self-tapping screws $\phi 2.2 \times 6$ mm
Clip, black	RAL 9005	

## BELT/ POCKET CLIP

Universal clip. Two location pillars for mounting into boreholes  $\phi 4.2$  mm at a center distance of 20 mm. Simple mounting by means of 2 self-tapping screws  $\phi 2.2 \times 6$  mm.

Part-No.

A 91 72 107

A 91 72 109



\*Mounting angle (C) on the adapter serves as a support to locate the case in the right position. After attachment of the adapter, the mounting angles can be easily removed.

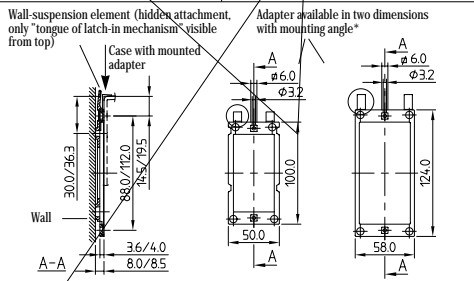

Version / Supply	
Plastic, 1 wall-susp. element each, 1 adapter 50 x 100 mm and assembly kit, recommended for shell-type cases 110 (without battery compart.), flat-pack cases 120, desk cases 190.	
Plastic, 1 wall-susp. element each, 1 adapter 58 x 124 mm and assembly kit, recommended for shell-type cases 155/190 (without battery compart.), flat-pack cases 150/189/210, desk cases 138.	

## WALL-SUSPENSION ELEMENTS

Universally applicable, for small plastic cases with 3 mm wall thickness. For easy machining. The adapter is screwed down together with the base part of the case. Due to preshaped pockets, each case can be quickly and securely unlatched from the wall-suspension element.

Part-No.

B 13 50 048

B 13 60 048

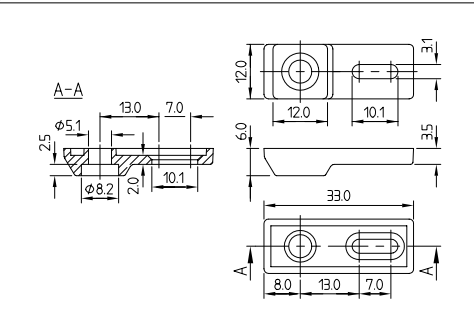

Version	Supply
Polyamide, pebble grey RAL 7032	4 pieces

## WALL-MOUNTING BRACKETS

Exterior wall-mounting elements for the SHELL-TYPE CASES 110, 155 and 190. Fastening to the case by means of the case fixing screws.

Part-No.

A 92 04 108

Subject to technical modification without notice. Typographical and other errors do not justify any claim for damages.  
Stand: 11/99 e Copyright © 1999 OKW Gehäusesysteme KG, Buchen, Germany (<http://www.okw.com>)

## TILT FOOT BAR

Universal tilt foot bar. Can be placed in any position to choose an ergonomical reading angle.

Simple mounting with 2 self-tapping screws,  $\varnothing 2.2 \times 6$  mm.

Necessary location holes:  $2 \times \varnothing 4.2$  mm at a center distance of 20 mm.

Suitable for the OKW cases:

- SHELL-TYPE CASE 110 and 155
- HAND-HELD-BOX P and M
- FLAT-PACK CASE

»Special version of tilt foot bar suitable for DATEC-MOBIL-BOX M and S see page 30.«

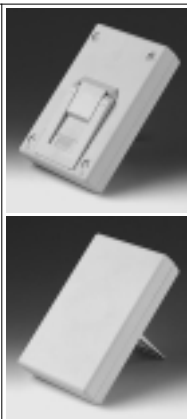
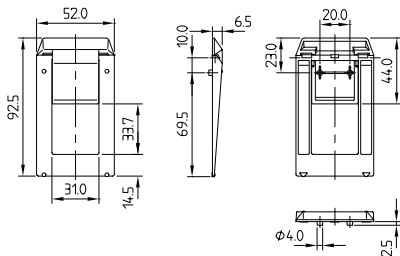

Part-No.

A 92 50 807

A 92 50 809

A 92 07 150

Article / Version

Tilt foot bar of ABS, off-white RAL 9002

Tilt foot bar of ABS, black RAL 9005

Clear non-slip pads

Supply

1 tilt foot bar

2 self-tapping screws  $\varnothing 2.2 \times 6$  mm

2 pieces  $\varnothing 6.5$  mm

## CASE FEET

Available in 2 versions:

Version I:

Case feet for universal application.

Version II:

Same version as version I but for combination with the tilt foot bar (next item). Clip mechanism for two different canting angles.

Example of mounting:

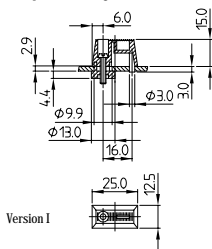

Version II

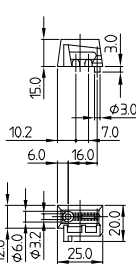

Part-No.

A 92 01 008

A 92 02 008

Article

Case feet, polystyrene, basalt grey RAL 7012

Case feet, polystyrene, basalt grey RAL 7012

Version

I

II

Supply

2 feet with accessories

2 feet with accessories



## TILT FOOT BAR

Part-No.

A 93 09 009

A 93 16 009

A 93 22 009

A 93 23 009

Dim. in mm

A a

104 88

174 158

234 218

246 230

Version /

Supply

Galvanized steel

1 wire section

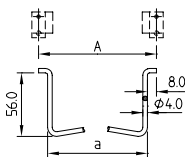

# ACCESSORIES

Case feet, Anti-slide feet, Self-tapping screws, Battery clips, Battery spacer



Case drilling details

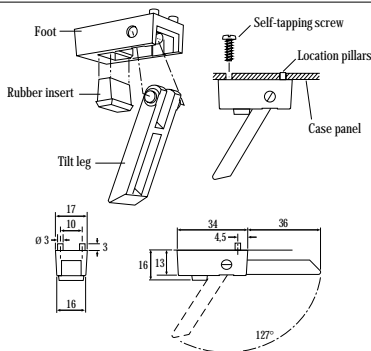
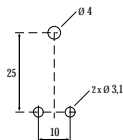

Version	Colour	Material
I	off-white, RAL 9002, rubber inserts pebble grey	ABS (UL 94 HB)
II	off-white, RAL 9002, rubber inserts pebble grey	ABS (UL 94 HB)
I	black, RAL 9005, rubber inserts pebble grey	ABS (UL 94 HB)
II	black, RAL 9005, rubber inserts pebble grey	ABS (UL 94 HB)

## CASE FEET

Universal case feet for all types of plastic and metal enclosures with max. 4 mm wall thickness.

Version I:

- 4 foot mouldings.
- 4 non-slip rubber inserts.
- 4 self-tapping screws.

Version II:

- As above but also including 2 tilt legs.

Part-No.

A 92 57 107

A 92 57 207

A 92 57 109

A 92 57 209

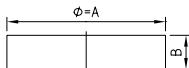

Dim. in mm	Colour	Material / Supply
A = Ø B		
6.5 2	transparent	Silicon, 2 pcs.
10 2.9	transparent	Silicon, 2 pcs.
12 3.5	transparent	Silicon, 2 pcs.

## ANTI-SLIDE FEET

Part-No.

A 92 07 150

A 92 10 290

A 92 12 330

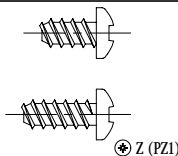

Self-tapping crosshead screw, specifically suitable for plastics.  
For fastening components, boards and PCBs onto pillars.

Version	Supply
2.5 x 6 mm	1 pc.
3 x 6 mm	1 pc.
3 x 8 mm	1 pc.

## SELF-TAPPING SCREWS

Part-No.

A 03 05 031

A 03 06 031

A 03 08 031

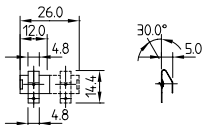

For round cells only (AA type). Useful for DATEC-MOBIL-BOX, SHELL-TYPE-CASE, LUX CASE and HAND-HELD-BOX.

Version / Supply
large, double contact, tin plated, 1 pc.
small, single contact, tin plated, 1 pc.
large, double contact, nickel plated, 1 pc.
small, single contact, nickel plated, 1 pc.

## BATTERY CLIPS

Part-No.

A 91 93 003

A 91 93 004

A 91 93 005

A 91 93 006

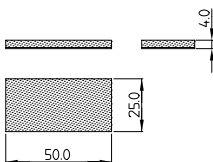

Suitable for:  
- DATEC-POCKET-BOX L  
- DATEC-MOBIL-BOX S  
- HAND-HELD-BOX N  
- LUX-CASES 150 and 190  
- SHELL-TYPE CASES  
Versions III and IV

Version / Supply
PE foam with one-sided adhesive coating, 1 pc.

## BATTERY SPACER

It serves to compensate for the differences in height and to secure the mignon cells (AA) within the battery compartments, which can also hold a 9 V flat battery (PP3).

Part-No.

A 92 50 250

**NEW:** Universal handle – available in any width almost for any housing.

The handle can be mounted from the outside and inside. It can be removed in the 135° position. Ratchet with 30° indexing. If the handle is overloaded the ratchet will automatically disengage to avoid damaging the mechanism!



## STANDARD COLOURS

Side arms:  
Off-white, RAL 9002.  
Push buttons:  
Volcano, NCS 5502-G.  
Center section:  
Silver, matt anodized.

## MATERIAL

Side arms glass reinforced polyamide. The center section extruded matt anodized aluminium. Stainless springs.

### Supply:

2 side arms.  
Fastening elements.  
1 aluminium center section (cut to your requested length).

### Order data:

Order the side arm kit and give us the width of your housing. We will supply the components as a set with the aluminium profile of the required length.

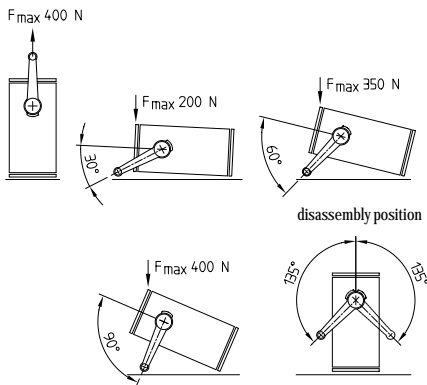
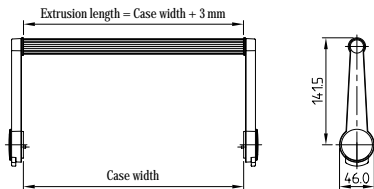

Part-No.

A 93 00 722

Article

Side arms kit

Colour

Side arms off-white RAL 9002 / push buttons volcano

# HANDLE BAR / BAIL ARM

Possible to mount from the inside



## STANDARD COLOURS

One-coloured:  
Off-white, RAL 9002 or black, RAL 9005.

Two-coloured:  
Side arms off-white, RAL 9002 and push buttons pebble grey, RAL 7032 or Side arms pebble grey, RAL 7032 and push button off-white, RAL 9002.

## MATERIAL

Side arms glass reinforced polyamide. The middle section extruded matt anodized aluminium.

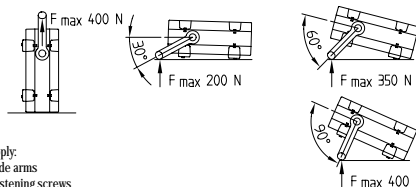
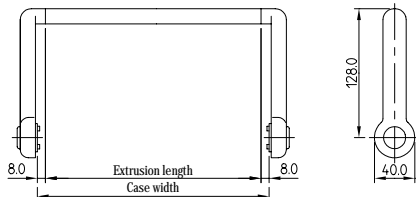

Supply:  
2 side arms  
2 fastening screws  
1 requested aluminium center section

Article	Colour combination	Part-No.
Side arms kit	off-white RAL 9002 / push buttons pebble grey RAL 7032	A 93.00.016
Side arms kit	off-white RAL 9002 / push buttons pebble grey RAL 9002	A 93.00.017
Side arms kit	pebble grey RAL 7032 / push buttons off-white RAL 9002	A 93.00.018
Side arms kit	black RAL 9005	A 93.00.015

## HANDLE BAR IN INJECTION MOULDED PLASTIC

Universal handle – available in any width almost for any housing.

Strong ratchet with 30° indexing.

### Order data:

Order the side arm kit and give us the width of your housing. We will supply the components as a set with the aluminium profile of the required length.



## STANDARD COLOURS

Side arms and mechanism off-white, RAL 9002, push button pebble grey, RAL 7032.  
Anti-glide rubber inserts black.

## MATERIAL

Side arms and mechanism diecast zinc.  
Push button plastic moulded glass reinforced polyamide.  
Extruded center section matt anodized aluminium.  
Anti-glide inserts in rubber.

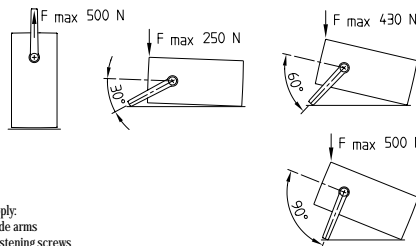
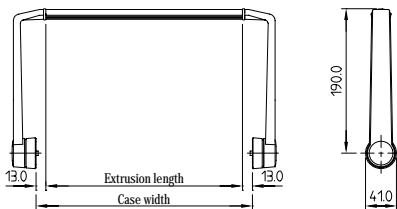

Supply:  
2 side arms  
2 fastening screws  
1 requested aluminium center section

Article	Colour combination
Side arms kit	Side arms off-white RAL 9002 / push buttons pebble grey RAL 7032

## HANDLE BAR IN DIECAST ZINC

Universal robust handle – available in any width almost for any housing.

Strong ratchet with 30° indexing.

### Order data:

Order the side arm kit and give us the width of your housing. We will supply the components as a set with the aluminium profile of required length.

In order to improve the stability, we recommend gluing the aluminium profiles with the lateral parts.

Part-No.  
A 93.00.014

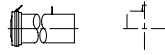

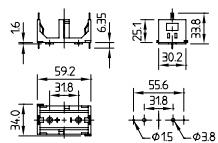
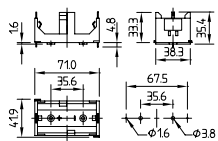
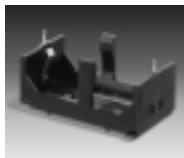

### CABLE GLANDS WITH PULL RELIEF

Part-No.

C 23 12 418  
C 23 16 418  
C 23 20 418  
C 23 20 428  
C 23 25 418  
C 23 32 418

M12  
M16  
M20  
M20  
M25  
M32

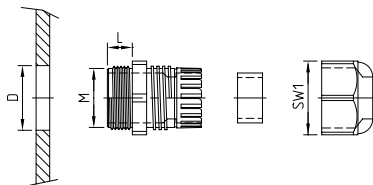

### CABLE GLANDS WITH PULL RELIEF AND BENDING PROTECTION

Part-No.

C 23 12 518  
C 23 16 518  
C 23 20 518  
C 23 20 528  
C 23 25 518

M12  
M16  
M20  
M20  
M25

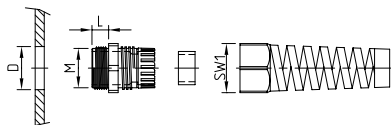

Cable glands of the best material for shake and twist-proof cable lead-in for OKW housings. High protection class IP 68.

### COUNTERNUTS

Part-No.

C 23 12 117  
C 23 16 117  
C 23 20 117  
C 23 25 117  
C 23 32 117

M12  
M16  
M20  
M25  
M32

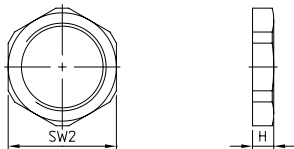

### STANDARD COLOURS

Cable glands silver grey, RAL 7001. Counternuts light grey, RAL 7035. Sealing ring natural-coloured.

### SEALING RING FOR EXTERNAL THREAD

Mounting between housing and gland flange to preserve the high protection class **IP 68** of the OKW cable glands.

Part-No.

C 23 12 126  
C 23 16 126  
C 23 20 126  
C 23 25 126  
C 23 32 126

M12  
M16  
M20  
M25  
M32

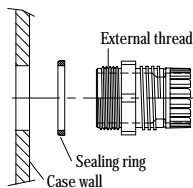

### MATERIAL

Cable glands and counternuts polyamide. Sealing ring of polyethylene.

### Comparison between PG and metric thread:

Mounting drills (ø in mm)

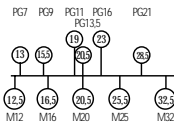

### KEY WIDTH

Dim. in mm

SW1 SW2 D L H

M12  
M16  
M20  
M20  
M25  
M32

M12	15	17	12.5	8	5
M16	22	22	16.5	8	5
M20	24	26	20.5	11	6
M20	27	26	20.5	15	6
M25	33	32	25.5	15	6
M32	42	41	32.5	15	7

### CLAMP RANGES

of all cable glands

ø 3 - 6.5  
ø 5 - 10  
ø 6 - 12  
ø 10 - 14  
ø 13 - 18  
ø 18 - 25