

In This Section...

Pos-E-Kon® Pin and Sleeve Connectors

Overview	G-2-G-3
Insert Selector System	G-4-G-5
Hood and Base Housings	G-6
Using the Catalog	G-7
Accessories	G-8-G-10
Important Notes	G-11
Catalog Number System	G-12
Series Locator	G-13
A Series 16 Amps 600 VAC	G-14-G-15
B Series 16 Amps 600 VAC	G-16-G-19
C Series 35 Amps 600 VAC	G-20-G-21
D Series 10 Amps 600 VAC	G-22-G-25
DD Series 10 Amps 600 VAC	G-26-G-29
K Series 80 + 16 Amps 600 VAC	G-30-G-31
V Series 16 Amps 600 VAC	G-32-G-35
T Series 16 Amps 600 VAC	G-36-G-37
Engineering Reference	G-38-G-41
Dimensions	G-42-G-54
Coding Options	G-55
Cable and Conduit Entry	G-56-G-57
Fiber Optic Connections	G-58-G-59

Pos-E-Kon® Pin and Sleeve Connectors

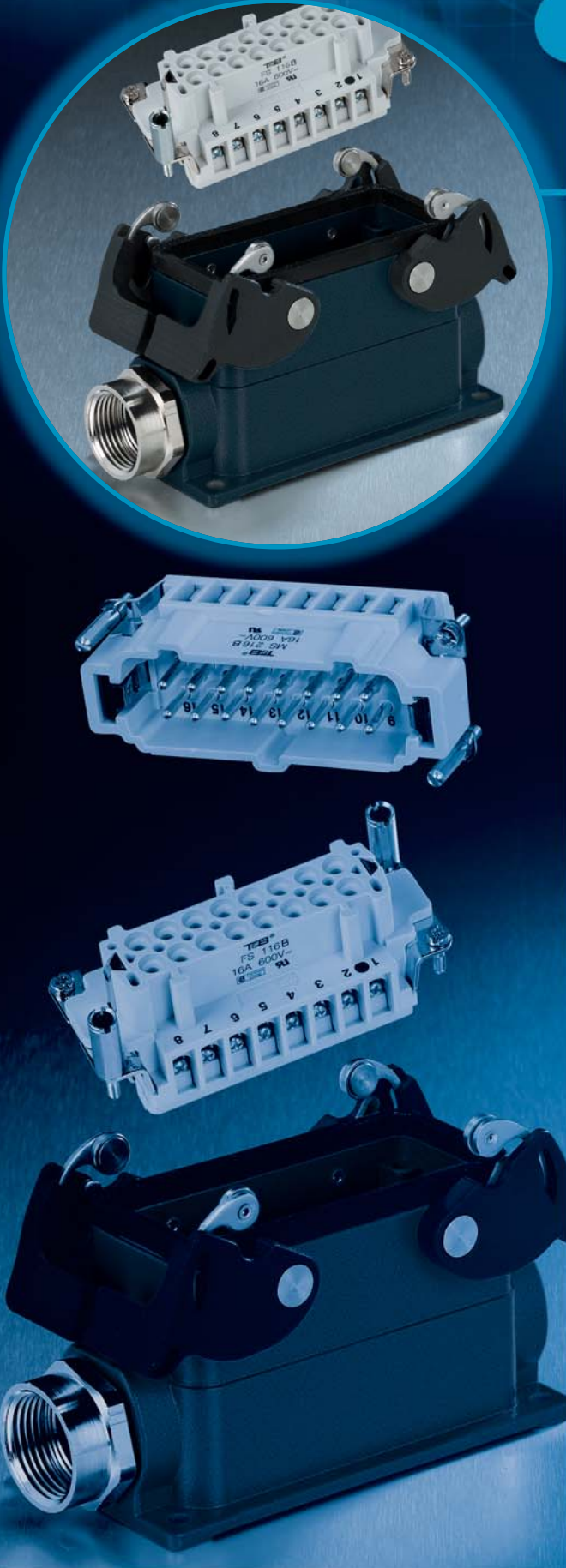

Thomas & Betts

United States
Tel: 901.252.8000
800.816.7809
Fax: 901.252.1354

Technical Services
Tel: 888.862.3289

Thomas & Betts

www.tnb.com

The FAQs About POS-E-KON® Interconnects The Most Frequently Asked Questions and Answers — for POS-E-KON Customers

International Standards, Worldwide Use

Why?

Rectangular Circuit Interconnections

- Best use of space for multiple contacts in heavy-duty housings
- Easy to assemble with many different insert options
- Best fit for easy access in panels, machinery and enclosures
- Sealed connector with quick disconnect handles
- Wide variety of circuit possibilities from standard items
- Solid or stranded wire in fixed or portable use

Who?

- Machine tool OEMs
- Material handling equipment OEMs
- Robotics systems OEMs and installations
- Packaging machinery OEMs and facilities
- Control panels and PLC systems
- Molding, assembly or line machinery OEMs and facilities
- Construction, mining and welding apparatus
- Carnival applications

What?

- Servo controls
- Sensing and feedback loops
- Conveyor and process controls
- Low power, DC or logic systems
- Combination power, system and other circuits
- Modular controls including fiber-optic connections

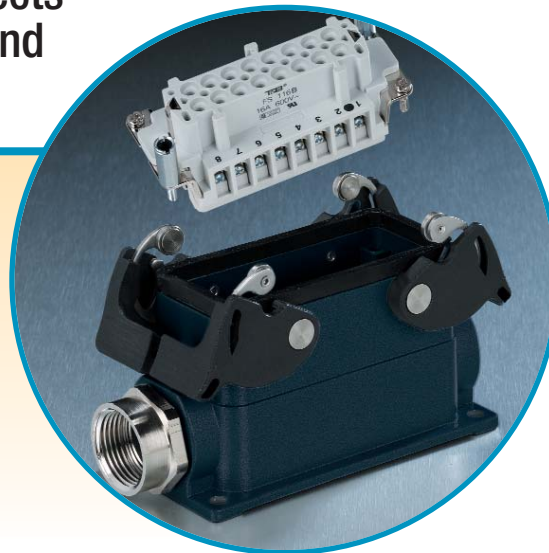

Where?

Worldwide agency approvals and applications

- DIN VDE 0627/86, 0110/02.79, and 0110-1/04.97
- IEC 60.664-1, DIN/IEC 512
- UL Recognized (E215386) and CSA Certified
- Protection classes IP44 through IP65 per IEC 529
- Component use in CE marked equipment OK per IEC Council Directive July 1999, 73/23/EEC
- Available from Thomas & Betts – POS-E-KON authorized distributors
- T&B sales representatives and agents worldwide

The Basic System: Build an Application

- Step 1** – Maximum voltage and amperage requirements (300V or 600V classes, 10-80 amps).
- Step 2** – Number of contacts or circuits needed.
- Step 3** – Choose wire terminations style; screw terminal or crimp contacts. Select series from charts.
- Step 4** – Base (or coupler) and hood construction/mating selection per series (single or double levers).



As Easy As 1. 2. 3. 4.

1. Hood:

- Separable housing for inserts
- Top or side conduit/wire entry
- Standard locking posts, dual or single
- Locks to Panel Base, Box Base or inline Coupler Hood

2. Base Housing (or Coupler Hood):

- Surface wall mount box base (shown)
- Panel Base for through-panel access
- Coupler Hood mating for portable use
- Single or dual "lever" locking

3. Male Insert

- Male contact carrier body
- Screw terminal contacts (pins with wire protection saddles) or crimp terminated pins

4. Female Insert

- Female contact carrier
- Screw terminal contacts (sleeves with wire protection saddles) or crimp terminated sleeves

DIN Standard Configurations

- Most inserts and housings are interface compatible with other DIN standard lines. Verify physical application before selecting cross reference.
- Pos-E-Kon construction includes standard NPT conduit adapters for hoods and bases, with many options available. DIN standard Hoods and Bases may have "Euro Style" PG fittings (or none) included unless specially ordered.

Pos-E-Kon Insert Selector Chart

S – Screw Terminals

C – Crimp Contacts

F – Fiber Optic (POF)

A – Terminal Block
Wiring Adapter

Select the # of contacts — all inserts have separate ground contacts

AMPS	VOLTS	SERIES	3	4	6	7	8	10	12	15	16	20	24	25	26	32	40	42	48	50-216
10	50	D					C, F													
10	600	A	S	S																
16	600	A						S, C			S, C					S, C				
16	600	B			S, C, A			S, C, A			S, C, A		S, C, A			S, C			S, C	
35	600	C			S				S											
10	600	D				C, F				C, F				C, F			C, F, A			C, F, A (64)
10	600	DD											C, F					C, F		C, F
80/16	600	K		S			S		4 or 8 Power (80A alone or with 8 or 16 Control (16A) Combination Inserts											
16-T	600	T			S			S			S	S				High Temp (200° C)				
316-V	600	V	S, C		S, C			S, C			S, C	S, C			S, C	S, C	Includes 2 Pilot Contacts			

Screw Terminal/Insert Types (Integral Contacts)

Screw termination is used for ease of assembly, some heavier gauge wires plus ease of maintenance. No tooling beyond a screwdriver and wire strippers is required.



Crimp Terminal/Insert Types (Crimp Contacts)

Crimp terminals offer solid, thermally cool vibration resistant terminations for OEM equipment and critical applications. Better for smaller AWG sizes also. Crimp tools are noted in each section.



- All crimp types represented require contacts ordered separately.
- Each section contains hand crimp tool selection notes.



Screw Terminal Inserts



- Integral screw terminal contacts provide for easy terminal wiring and fast assembly
- Standard wire protection saddles prevent cutting of strands during assembly

Crimp Terminal Inserts



- Provides reliable connections for long-term configurations
- Contact sizes accommodate wiring from 12–20 AWG

- Made of durable glass fiber-filled thermoplastic
- Contact numbers clearly marked for easy identification
- Easily installed (male or female) in either hoods or bases using captive mounting screws

Terminal Block Wiring Adapters

WAR, Right Ground Strap
WAL, Left Ground Strap

- Allows for measuring of circuit while in operation
- Provide easy connections in panel mounting configurations
- Labels available for easy identification of circuits
- Can be mounted on DIN rails by using snap-on mounting feet
- Used in switch cabinets, panel enclosures or mounted in panel base housings — see B and D series

Insert Strip Blank – WAM1B

Insert Strip Nos. 1–64 – WAM1N64

Insert Strip Letters A–Z – WAM1AZ

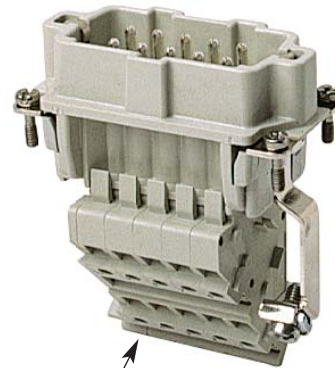

WAM1 MARKER TAB CLIPS

Snap-in formed label holder tabs allow terminal identification for B Series.



DIN Mounting Foot FE807TB

Hood and Base Housings

- **Rugged cast aluminum hoods and bases:** Maximum performance in many operating conditions
- **Various hood heights available:** Easier assembly and wiring with low, high and standard profiles
- **Corrosion-resistant finishes:** Optional special materials extend life in corrosive conditions
- Locking possibilities include **single locking** system and **double locking** system
- **Complete selection:** Flexible product designs (see Hood/Base Size Cross Reference Chart below)
- **Dust Covers and More:** See Adapters, p. G-9–G10 and Covers p. G-8 (or Bases w/Covers) available in most series (Accessories p. G-52), see p. G-53–G-54 for all Adapter Plates
- **Custom Configurations:** Multiple conduit entry/sizes and other configurations available to spec

Cross Reference — Inserts

AMPS	VOLTS	SERIES	A4	A10	A16	AA32	B6	B10	B16	B24	B32	B48
Series Application			Standard Hood/Base Housing									
10A	50	D	D8									
10A	600	A	A3, A4									
16A	600	A		A10	A16	A32						
16A	600	B					B6	B10	B16	B24	B32	B48
35A	600	C							C6		C12	
10A	600	D	D7	D15	D25	D50			D40	D64	D80	D128
10A	600	DD					DD24	DD42	DD72	DD108	DD144	DD216
80/16A	600	K								K4/8		K8/16
Series Application			Special Series Hood/Base Housing									
16A-T*	600	T					T6	T10	T16	T24		
16A-V**	600	V						V3	V6	V10		V32

* Special high temperature series in Cu-Free Aluminum with special green epoxy powder-coat, Viton® seals.†

** Special isolation design allows additional control circuit capability.

† Viton® is a trademark of DuPont Performance Elastomers.



Box Base



Top Cable Entry



Box Base Housing with Single lever and spring cover. Metal spring covers available for B series, where noted.



Panel Base

Side Cable Entry



Using the Catalog: Series Layout

1. Select size (# of contacts) from each series' section left-hand page chart (selected inserts), then look at corresponding right-hand page columns.
2. Vertical columns note single or double locking systems available (double locking usually preferable).
3. Select base housings for mounting and/or function: conduit/cable entry, thru-panel access, inline coupler or reversed locking as shown. (Note profile height options.)
4. Select side or top entry hoods as shown. (Note profile height options.)
5. Review conduit and cable entry options (standard NPT adapter sizes for each series).

Note: M Series (layout) groups interior options, followed by base selection options.

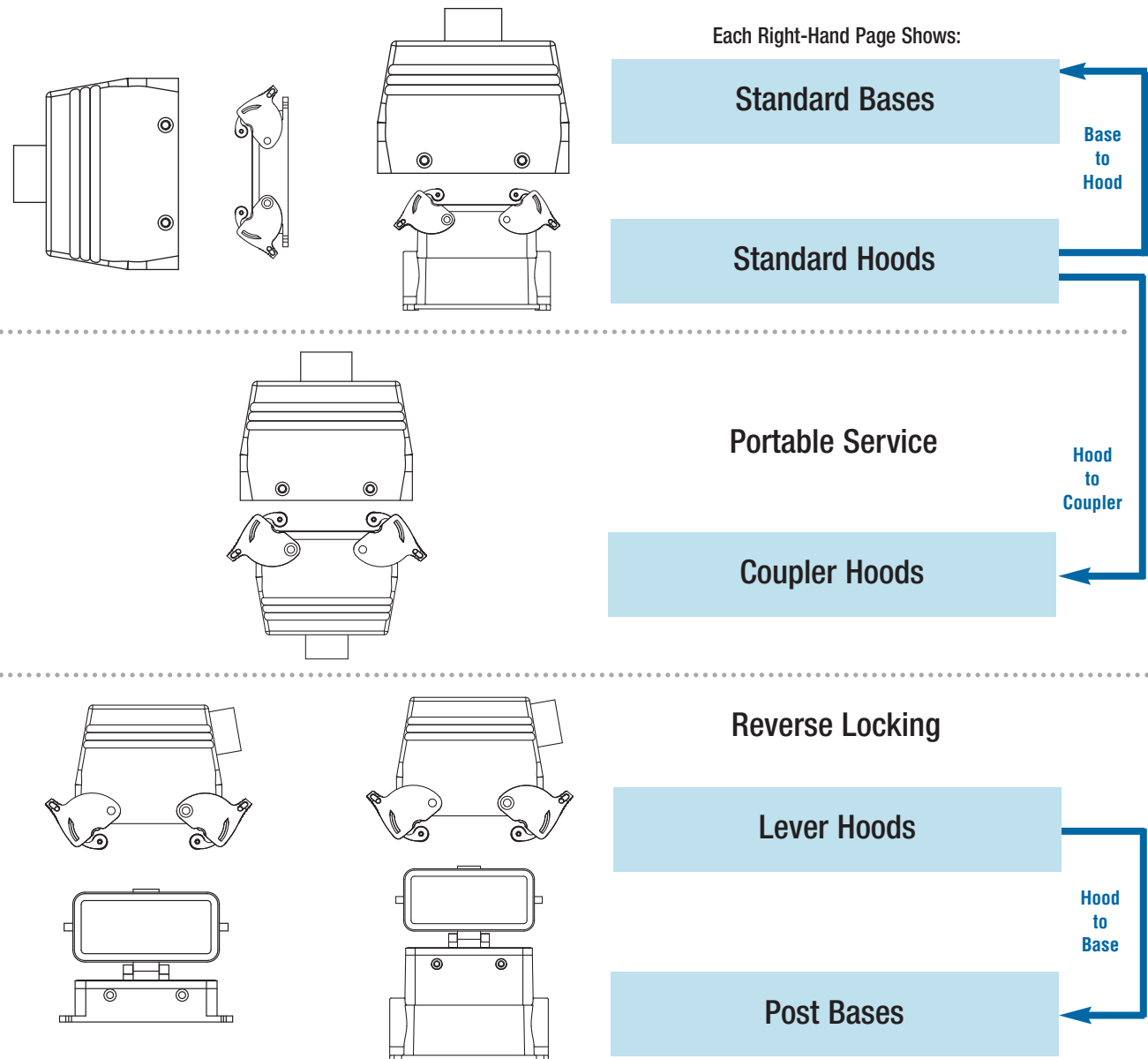



Sub-Miniature (DB) Adapter Plates

- Connect test and diagnostic equipment to control circuits
- Panel base, box housing base or any hood installation (ribbon cable — entry hoods available)
- Industry standard sizes
- Dust covers for protection recommended
- 9, 15, 25, 37 and 50 series

See page G-53 for ordering information and dimensions.



B24 Insert Mounting Adapter Plates

- Allows housing standardization for multiple applications
- B24 footprint fit to single B6, B10, B16 inserts
- Rugged thermoplastic
- Fits standard B24 Hoods and Bases

B24 Insert Mounting Adapter Plates

- Allows custom connections for drill-and-install work
- Blank plate for expansion
- All standard Hood/Base sizes supported

See page G-54 for ordering information and dimensions.



Dust Covers & Hinged Covers

(thermoplastic) (thermoplastic or metal)

- Separate covers or fixed mount hinged types
- Metal fixed-mount hinged covers for B series bases available in select sizes
- Separate or fixed covers protect contacts when not in use or while unmated



Wire and Cable Entry Options



Cable Compression
Seal Fitting



Strain Relief
Trumpet Gland



Euro Gland Seal

Portable Service Cord

- Sheathed industrial multi-conductor cables usage
- Options cover many installation needs
- Special constructions available for retrofit or original specification
- Hoods and Bases may be specified (in bulk volumes)
- Euro standard gland seal also available



Box Base Series Set



Hood Seal Set

Ribbon or Flat Cable Sealing

- Single, double or triple cable entry options
- Hoods must be specified as ribbon cable entry style
- Sealing sets available separately
- Box base housing sealing sets also available



Standard NPT Conduit Adapters

- Euro PG to NPT thread adapters (PG male to NPT female)
- Standard on all Pos-E-Kon Hoods and Bases
- Available separately for MRO
- Sizes from (PG11 to 1/2") through (PG48 to 1 1/2") NPT



Cord Grip Fittings

- Both NPT and PG thread styles
- Thermoplastic sealing glands in NPT, PG and ISO threads — for retrofit or original specification
- More options than shown are available. (shown in gray; black also available)

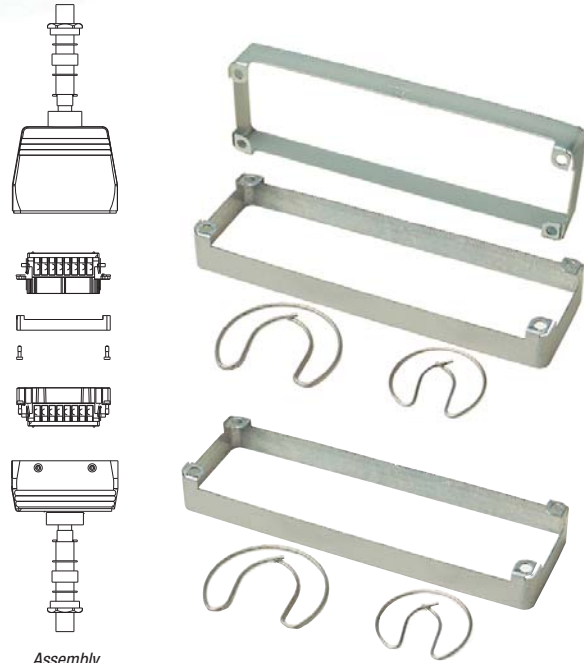

Assembly Structure Example

Electro-Magnetic Shielding Component Systems

- EM shielding at critical sealing lines
- Hood/Base and Coupler Hood kits

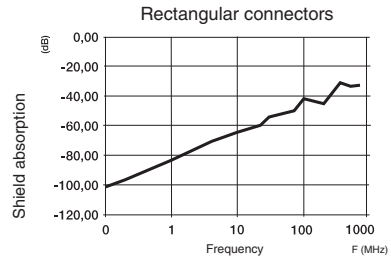

Shielding Kits

INSERTS/SERIES	BASE & HOOD KIT	COUPLER HOOD KIT
A10, D15	EM650A10	EM656A10
A16, D25	EM651A16	EM657A16
B6, T6, DD24	EM646B6	EM652B6
B10, T10, V3, DD42	EM647B10	EM653B10
B16, T16, C6, V6, D40, DD72	EM648B16	EM654B16
B24, T24, V10, V16, D64, DD108	EM649B24	EM655B24

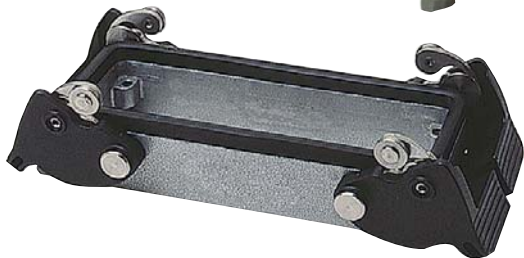

Bulkhead/Panel Pass-Through Adapters

- For panel wiring access through panel base entry
- Clamshell "Split Type" design also available
- 3 or 4 entry (4 standard)
- Base B16 or B24 sizes
- Grommets sold separately, see chart below

Adapter Housing and Base

SERIES NO.	ADAPTER	PANEL BASE
B16, T16, C6, V6, D40, DD72 (3 hole)	CA628B16	PB116
B24, T24, V10, V16, D64, DD108 (4 hole)	CA629B24	PB124

Feed-Thru Grommets

CABLE O.D. (MM)	CAT. NO.	CABLE O.D. (MM)	CAT. NO.
3-4	BSG630	10-11	BCG637
4-5	BSG631	11-12	BCG638
Straight Grommet	5-6	Split Type	12-13
	6-7	Grommet	13-14
7-8	BSG634	14-15	BCG641
8-9	BSG635	15-16	BCG642
9-10	BSG636	* Use T&B Ty-Rap® No. TYV523M cable tie to bind wire to open face grommet.	
Blind Plug	-		BPG644

Easy-to-use catalog number construction pioneered by T&B:

Hoods

- TH** – Top Entry Hood with NPT fitting
- SH** – Side Entry Hood with NPT fitting

Wiring Entry options

- Cord or Conduit Adapter fittings
- Ribbon cable and Euro cable entry
- Housings without fittings
- Custom assemblies

Male and Female Terminal Block Wiring Adapters

- MS** or **FSxxxWAR/WAL**
- (right/left ground) options
- for Panel Base installations



Double posts (front/back)
for Double Lever locking.
(single side posts/lever also)



Male and Female Inserts

- same installation to any hood
- or base orientation

MS – Male Screw Terminal Insert (shown)

FS – Female Screw Terminal Insert (shown)

– OR –

MC – Male Crimp Insert

FC – Female Crimp Insert

>use **MP** –Male and **FP** –Female Pins



PB – Panel Base Housing
Panel face or bulkhead
mounting with rear
wiring access

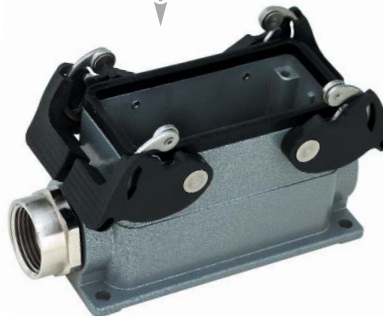

BB – Box Base Housing Surface
Mount with NPT conduit
Entry (1 or 2) fittings
(standard)



CH – Coupler Hood
Inline Portable Connection

Locking

- Single lever/Single posts or Double lever/Double posts locking
- “Reversed Locking” (levers on hoods) available
- E-series ergonomic thermoplastic handles for Double lever B series (B10, B16, B24)
- Single lever and other series use metal levers

Series Locator

	SERIES	FEATURES	CONTACTS + G	PAGE
	A Series 10A: 3, 4 16A: All others	Small, Compact Size Screw Terminal or Crimp Contact	3, 4, 10, 16, 32	G-14
	B Series 16A	Standard Size Screw Terminal or Crimp Contacts	6, 10, 16, 24, 32, 48	G-16
	C Series 35A	High Current Screw Terminal	6 or 12	G-20
	D Series 10A	Hi-Density Crimp Contacts or Fiber Optic Contacts	7, 8, 15, 25, 40, 50, 64, 80, 128	G-22
	DD Series 10A	Very Hi-Density Crimp Contacts or Fiber Optic Contacts	24, 42, 72, 108, 144, 216	G-26
	K Series 16A/80A	Combo, Hi-Current/Std. Current Screw Terminals	16A: 8 + 4 80A: 16 + 8	G-30
	V Series 16A	Control Circuit Contacts and B Style Screw Terminals	3, 6, 10, 16,)+2 20, 26, 32	G-32
	T Series 16A	B Style @ Hi-Temp 200°C Screw Terminals	6, 10, 16, 24	G-36
	Reference & Accessories	Specs, Dimensions, Components and Fiber Optics		G-38

Pos-E-Kon® Pin and Sleeve Connectors

Pos-E-Kon®

A Series 16 Amps 600 VAC



3 or 4 Contacts + Ground: 10A
10, 16 & 32 Contacts + Ground: 16A

Install to Matching Series Hood/Base



3 or 4 (600V)	10	16	32
---------------	----	----	----



Screw Terminal Inserts

SCREW TERMINAL INSERTS	3 OR 4 + G	10 + G	16 + G	32 + G
 <p>MALE – PINS 20-14 AWG (0.5-2.5 mm²)</p>	MS203A or MS204A (16 AWG max)	MS210A	MS216A	MS216A+ MS232A
 <p>FEMALE – SLEEVES 20-14 AWG (0.5-2.5 mm²)</p>	FS103A or FS104A (16 AWG max)	FS110A	FS116A	FS116A+ FS132A

Crimp Terminal Inserts

CRIMP TERMINAL INSERTS	—	10 + G	16 + G	32 + G
 <p>MALE INSERT (Order contacts below)</p>	—	MC410A	MC416A	MC416A+ MC432A
 <p>FEMALE INSERT (Order contacts below)</p>	—	FC310A	FC316A	FC316A+ FC332A



Use small blade screwdriver to push wire entry tab in for easy contact removal.





Crimp Tool

CAT. NO.

WT611TB

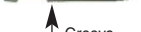

Contacts Selection

CRIMP CONTACTS	WIRE AWG (MM ²)	IDENTIFICATION
	20 AWG (0.5 mm ²)	No Groove
	18 AWG (0.75-1 mm ²)	1 Groove
	16 AWG (1.5 mm ²)	2 Grooves
	14 AWG (2.5 mm ²)	3 Grooves
	12 AWG (4.0 mm ²)	No Groove

For all Crimp Terminal "A" Inserts:

FEMALE	MALE
FP2000	MP2000
FP1800	MP1800
FP1600	MP1600
FP1400	MP1400
FP1200	MP1200



of Contacts + Ground Connection

Bases – Standard Mount				3 or 4 (600V)	10	16	32
SINGLE LEVER	DOUBLE LEVER	HOUSING	NPT ENTRY	LEVER LOCKING TYPE			
				SINGLE	SINGLE	SINGLE	DOUBLE
		Panel Base w/Cover		PB303A(P) ¹ PB403A	PB310A PB410A	PB316A PB416A	PB132A
		Angled no Cover		PB503A(P) ¹			
		Box Base (no Cover)	1 X 3/8" 1 X 1/2" 1 X 3/4" 1 X 1" 2 X 1/2" 2 X 3/4" 2 X 1"	BB403A(P) ¹	BB410A BB510A	BB416A BB516A	BB032A BB832A BB132A BB132A100
		Box Base w/Cover	1 X 1/2" 2 X 1/2"		BB610A BB710A	BB616A BB716A	

Base
Base to Hood

Hoods — Standard Mount **Plastic body — "A" 3-16 Series standard Hoods include Gaskets: Bases and Special Hoods do not.*

		Side Entry	1 X 3/8" 1 X 1/2" 1 X 3/4" 1 X 1"	SH603A(P) ¹	SH610A** SH710A**	SH616A** SH716A**	SH032A SH132A
		Top Entry	1 X 3/8" 1 X 1/2" 1 X 3/4" 1 X 1"	TH803A(P) ¹	TH810A** TH910A**	TH816A** TH916A**	TH232A TH332A

Hoods
Hood to Coupler

Coupler Hoods — Inline *For Inline, Portable or Special Service Connections. Coupler Hoods mate to Standard Hoods ONLY.*

		Top Entry	1 X 3/8" 1 X 1/2"	CH803A(P) ¹	CH810A	CH816A	
--	--	-----------	----------------------	------------------------	--------	--------	--

Coupler

Lever Hoods – Reverse Locking *Lever Hoods mate to Post Bases ONLY.*

		Side Entry w/Lever(s)	1 X 3/4" 1 X 1"				LH032A LH132A
		Top Entry w/Lever(s)	1 X 3/4" 1 X 1"				LH232A LH332A

Hoods
Hood to Base

Bases – with Access Cover *Post Bases accept Lever Hoods ONLY.*

		Panel Base+ Posts w/Cover					PB232A
		Box Base+ Posts w/Cover	1 X 3/4" 1 X 1" 2 X 3/4" 2 X 1"				BB232A BB232A100 BB332A BB332A100

Bases

**Notes: Available in Standard or LOW Profile "L" configurations. (add suffix)

¹ (P) indicates glass-filled thermoplastic construction, light gray color (add suffix).

(PB) indicates glass-filled thermoplastic construction, black color (add suffix), quantity purchase may be required.



6, 10, 16, 24, 32, 48 Contacts + Ground

Install to Matching Series Hood/Base



6	10	16
---	----	----





Screw Terminal Inserts

SCREW TERMINAL INSERTS	6 + G	10 + G	16 + G
 MALE – PINS 20–14 AWG (0.5–2.5 mm ²)	MS206B	MS210B	MS216B
 FEMALE – SLEEVES 20–14 AWG (0.5–2.5 mm ²)	FS106B	FS110B	FS116B



Screw Terminal Wiring Adapter Blocks

SCREW TERMINAL WIRING ADAPTER BLOCKS	6 + G	10 + G	16 + G
 MALE INSERT, GROUND L. 20–14 AWG (0.5–2.5 mm ²)	MS206WAL	MS210WAL	MS216WAL
MALE INSERT, GROUND R. 20–14 AWG (0.5–2.5 mm ²)	MS206WAR	MS210WAR	MS216WAR
 FEMALE INSERT, GROUND L. 20–14 AWG (0.5–2.5 mm ²)	FS106WAL	FS110WAL	FS116WAL
FEMALE INSERT, GROUND R. 20–14 AWG (0.5–2.5 mm ²)	FS106WAR	FS110WAR	FS116WAR
 FOOT ELEMENT MOUNTING adapter for DIN rail	FE807TB 2 each needed	FE807TB 2 each needed	FE807TB 2 each needed

Crimp Terminal Inserts

CRIMP TERMINAL INSERTS	6 + G	10 + G	16 + G
 MALE INSERT (Order contacts below)	MC406B	MC410B	MC416B
 FEMALE INSERT (Order contacts below)	FC306B	FC310B	FC316B

Contacts Selection

CRIMP CONTACTS	WIRE AWG (MM ²)	IDENTIFICATION	For all Crimp Terminal "B" Inserts	
			FEMALE	MALE 16 + G
 Groove	20 AWG (0.5 mm ²)	No Groove	FP2000	MP2000
	18 AWG (0.75–1 mm ²)	1 Groove	FP1800	MP1800
	16 AWG (1.5 mm ²)	2 Grooves	FP1600	MP1600
	14 AWG (2.5 mm ²)	3 Grooves	FP1400	MP1400
 No Groove	12 AWG (4.0 mm ²)	No Groove	FP1200	MP1200

Wiring Adapter Insert for use with Panel Bases; allows single access direction panel-build wiring and easy terminal ID for service and testing.

ACCESSORIES:	CATALOG NO.
Label Insert Clip	WAM-1
Strip blank	WAM1B
Strip Nos. 1-64	WAM1N64
Strip Letters A - Z	WAM1AZ



Use small blade screwdriver to push wire entry tab in for easy contact removal.

Crimp Tool

CAT. NO.
WT611TB



of Contacts + Ground Connection

Bases – Standard Mount				6	10	16		
SINGLE LEVER	DOUBLE LEVER	HOUSING	NPT ENTRY	LEVER LOCKING TYPE				
				SINGLE	SINGLE	DOUBLE	SINGLE	DOUBLE
		Panel Base w/Cover		PB306** PB406**	PB310 PB410**	PB110E	PB316** PB416**	PB116E
		Box Base no Cover	1 X 1/2" 1 X 3/4" 1 X 1" 2 X 1/2" 2 X 3/4" 2 X 1"	BB406 BB406H075 BB406H100 BB506 BB506H075 BB506H100	BB410 BB410H075 BB410H100 BB510 BB510H075 BB510H100	BB010E BB010EH075 BB010EH100 BB110E BB110EH075 BB110EH100	BB416* BB416H100	BB016E* BB016EH100
		Box Base w/Cover	1 X 1/2" 1 X 3/4" 1 X 1" 2 X 1/2" 2 X 3/4" 2 X 1"	BB606** BB606H075** BB606H100** BB706** BB706H075** BB706H100**	BB610** BB610H075** BB610H100** BB710** BB710H075** BB710H100**		BB616* ** BB616H100**	

Hoods — Standard Mount **Plastic body — "B" 3-16 Series standard Hoods include Gaskets: Bases and Special Hoods do not.*

		Side Entry	1 X 1/2" 1 X 3/4" 1 X 1"	SH606 SH606H075 SH606H100	SH610 SH610H075 SH610H100	SH010 SH010H075 SH010H100	SH616 [†] SH716H [†]	SH016 [†] SH116H
		Top Entry	1 X 1/2" 1 X 3/4" 1 X 1"	TH806 TH806H075 TH806H100	TH810 TH810H075 TH810H100	TH210 TH210H075 TH210H100	TH816 [†] TH816H100	TH216 [†] TH316H

Coupler Hoods – Inline *For Inline, Portable or Special Service Connections. Coupler Hoods mate to Standard Hoods ONLY.*

		Top Entry	1 X 1/2" 1 X 3/4" 1 X 1"	CH806H CH806H075 CH806H100	CH810E CH810H075 CH810H100	CH610E CH610EH075 CH610EH100	CH816H CH916H	CH616EH CH716EH
--	--	-----------	--------------------------------	----------------------------------	----------------------------------	------------------------------------	------------------	--------------------

Lever Hoods – Reverse Locking *Lever Hoods mate to Post Bases ONLY.*

	Side Entry w/Lever(s)	1 X 1/2" 1 X 3/4" 1 X 3/4"		LH010E LH010EH075 LH010EH100		LH016E* LH116EH
	Top Entry w/Lever(s)	1 X 1/2" 1 X 3/4" 1 X 1"		LH210E LH210EH075 LH210EH100		LH216E* LH316EH

Bases – with Access Cover *Post Bases accept Lever Hoods ONLY.*

	Panel+ Posts Posts w/Cover					PB210**		PB216**
	Box Base+ Posts w/Cover	1 X 1/2" 1 X 3/4" 1 X 1" 2 X 1/2" 2 X 3/4" 2 X 1"				BB210** BB210H075** BB210H100** BB310** BB310H075** BB310H100**		BB216* ** BB216H100** BB316** BB316H100**

* Notes: Available in Standard or HIGH Profile "H" configurations. (-add suffix)

** Add "M" final suffix for metal cover option.



† Both HIGH (H) and LOW (L) profile also available. (-add suffix)

6, 10, 16, 24, 32, 48 Contacts + Ground





Install to Matching Series Hood/Base

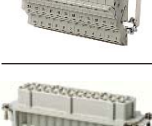

Screw Terminal Inserts

SCREW TERMINAL INSERTS	24 + G	32 + G	48 + G
 <p>MALE – PINS 20–14 AWG (0.5–6 mm²)</p>	MS224B	MS216B (1–16) +MS232B (17–32)	MS224B (1–24) +MS248B (25–48)
 <p>FEMALE – SLEEVES 20–14 AWG (0.5–6 mm²)</p>	FS124B	FS116B (1–16)+ FS132B (17–32)	FS124B (1–24)+ FS148B (25–48)

Screw Terminal Wiring Adapter Blocks

SCREW TERMINAL INSERTS	24 + G
 <p>MALE INSERT, GROUND L. 20–14 AWG (0.5–2.5 mm²)</p>	MS224WAL
 <p>MALE INSERT, GROUND R. 20–14 AWG (0.5–2.5 mm²)</p>	MS224WAR
 <p>FEMALE INSERT, GROUND L. 20–14 AWG (0.5–2.5 mm²)</p>	FS124WAL
 <p>FEMALE INSERT, GROUND R. 20–14 AWG (0.5–2.5 mm²)</p>	FS124WAR
 <p>FOOT ELEMENT MOUNTING Adapter for DIN rail</p>	FE807TB

Accessories



Wiring Adapter Insert for use with Panel Bases; allows single access direction panel-build wiring and easy terminal ID for service and testing.

CAT. NO.	DESCRIPTION
WAM-1	Label Insert Clip
WAM1B	Strip blank
WAM1N64	Strip Nos. 1–64
WAM1AZ	Strip Letters A–Z



Use small blade screwdriver to push wire entry tab in for easy contact removal.

Crimp Terminal Inserts

CRIMP TERMINAL INSERTS	24 + G	32 + G	48 + G
 <p>MALE INSERT (Order contacts below)</p>	MC424B	(1–16) MC416B (17–32) MC432B	(1–24) MC424B (25–48) MC448B
 <p>FEMALE INSERT (Order contacts below)</p>	FC324B	(1–16) FC316B (17–32) FC332B	(1–24) FC324B (25–48) FC348B

Crimp Tool

CAT. NO.	WT611TB
	

Contacts Selection

CRIMP CONTACTS	WIRE AWG (MM ²)	IDENTIFICATION
	20 AWG (0.5 mm ²)	No Groove
	18 AWG (0.75–1 mm ²)	1 Groove
	16 AWG (1.5 mm ²)	2 Grooves
	14 AWG (2.5 mm ²)	3 Grooves
	12 AWG (4.0 mm ²)	No Groove

For all Crimp Terminal "B" Inserts:

FEMALE	MALE
FP2000	MP2000
FP1800	MP1800
FP1600	MP1600
FP1400	MP1400
FP1200	MP1200

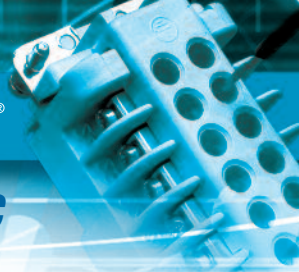

of Contacts + Ground Connection

Bases – Standard Mount				24	32	48		
SINGLE LEVER	DOUBLE LEVER	HOUSING	NPT ENTRY	LEVER LOCKING TYPE				
				SINGLE	DOUBLE	DOUBLE	SINGLE	
		Panel Base w/Cover		PB324 PB424 [†]	PB124E	PB132	PB348 PB448	Base Base to Hood
		Box Base no Cover	1 X ¾" 1 X 1" 2 X ¾" 2 X 1"	BB424* BB424H100 BB524* BB524H100	BB024E* BB024EH100 BB124E* BB124EH100	BB032 BB132	BB448 BB548	
		Box Base w/Cover	1 X ¾" 1 X 1" 2 X ¾" 2 X 1"	BB624* [†] BB624H100 [†] BB724* [†] BB724H100 [†]			BB648 BB748	

Hoods — Standard Mount **Plastic body — "A" 3-16 Series standard Hoods include Gaskets: Bases and Special Hoods do not.*

		Side Entry	1 X ¾" 1 X 1" 1 X 1¼"	SH624** SH724**	SH024** SH124**	SH032 SH132 SH132-125	SH648 SH748	Hoods Hood to Coupler
		Top Entry	1 X ¾" 1 X 1" 1 X 1¼" Ribbon Cbl	TH824** TH924** TH624RC [‡]	TH224** TH324** TH424RC [‡]	TH232 TH332 TH332-125	TH848 TH948	

Coupler Hoods — Inline *For Inline, Portable or Special Service Connections. Coupler Hoods mate to Standard Hoods ONLY.*

		Top Entry	1 X ¾" 1 X 1" Ribbon Cbl	CH824 CH924 CH824RC [‡]	CH624E CH724E CH724ERC [‡]	CH632 CH732		Coupler
--	--	-----------	--------------------------------	--	---	----------------	--	---------

Lever Hoods – Reverse Locking *Lever Hoods mate to Post Bases ONLY.*

		Side Entry w/Lever(s)	1 X ¾" 1 X 1"		LH024E LH124E			Hoods Hood to Base
		Top Entry w/Lever(s)	1 X ¾" 1 X 1"		LH224E LH324E			

Bases – with Access Cover *Post Bases accept Lever Hoods ONLY.*

	Panel Base w/Posts + Cover				PB224 [†]			Bases
	Box Base w/Posts + Cover	1 X ¾" 1 X 1" 2 X ¾" 2 X 1"			BB224* [†] BB224H100 BB324* [†] BB324H100			

*Notes: Available in Standard or HIGH Profile "H" configurations. (-add suffix)

[†] Add "M" final suffix for metal cover option.

**Notes: Available in Standard or LOW Profile "L" configurations. (-add suffix)

[‡] See page G-57 for ribbon cable kits.

Pos-E-Kon®

C Series 35 Amps 600 VAC

6 or 12 Contacts + Ground



Install to Matching Series Hood/Base

6

12



Screw Terminal Contact Carrier Inserts

SCREW TERMINAL CONTACT CARRIER INSERTS		6 + G	12 + G
	MALE – PINS 20–10 AWG (0.5–6 mm ²)	MS206C	MS206C (1–6)+ MS212C (7–12)
	FEMALE – SLEEVES 20–10 AWG (0.5–6 mm ²)	FS106C	FS106C (1–6)+ FS112C (7–12)

Pos-E-Kon® Pin and Sleeve Connectors

Thomas & Betts

United States
Tel: 901.252.8000
800.816.7809
Fax: 901.252.1354

Technical Services
Tel: 888.862.3289

of Contacts + Ground Connection

Bases – Standard Mount

				6	12		
SINGLE LEVER	DOUBLE LEVER	HOUSING	NPT ENTRY	LEVER LOCKING TYPE			
				SINGLE	DOUBLE	DOUBLE	
		Panel Base		PB316	PB116E	PB132	Base
		w/Cover		PB416			
		Box Base no Cover	1 X ¾"	BB416*	BB016E*	BB032	Base to Hood
			1 X 1"	BB416H100	BB016EH100		
2 X ¾"	BB516*	BB116E*	BB132				
2 X 1"	BB516H100	BB116EH100					
		Box Base w/Cover	1 X ½"	BB616**†			
			1 X 1"	BB616H100†			
2 X ½"	BB716**†						
2 X 1"	BB716H100†						

Hoods — Standard Mount

		Side Entry	1 X ¾"	SH616† SH716H	SH016† SH116H	SH032 SH132 SH132-125	Hoods
			1 X 1"				
1 X 1 ¼"							
		Top Entry	1 X ¾"	TH816† TH816H100	TH216† TH316H	TH232 TH332 TH332-125	Hood to Coupler
			1 X 1"				
1 X 1 ¼"							

Coupler Hoods – Inline *For Inline, Portable or Special Service Connections. Coupler Hoods mate to Standard Hoods ONLY.*

		Top Entry	1 X ¾"	CH816H CH916H	CH616EH CH716EH	CH632 CH732	Coupler
			1 X 1"				

Lever Hoods – Reverse Locking *Lever Hoods mate to Post Bases ONLY.*

	Side Entry w/Lever(s)	1 X ¾" 1 X 1"		LH016E* LH116EH		Hoods
	Top Entry w/Lever(s)	1 X ¾" 1 X 1"		LH216E* LH316EH		

Bases – with Access Cover *Post Bases accept Lever Hoods ONLY.*

	Panel+ Posts			PB216†		Bases
	Box Base+ Posts w/Cover	1 X ¾" 1 X 1" 2 X ¾" 2 X 1"		BB216**† BB216H100† BB316**† BB316H100†		

* Notes: Available in Standard or HIGH Profile "H" configurations. (-add suffix)

** Notes: Available in Standard or LOW Profile "L" configurations. (-add suffix)

† Add "M" final suffix for metal cover option.

‡ Both HIGH (H) and LOW (L) profile also available. (-add suffix)

Pos-E-Kon®

D Series 10 Amps 600 VAC



7 or 8, 15, 25 & 40 Contacts + Ground

Install to Matching Series Hood/Base

7 or 8	15	25	40
--------	----	----	----



Crimp Terminal Inserts

CRIMP TERMINAL INSERTS	7 OR 8 + G	15 + G	25 + G	40 + G
 MALE INSERT (Order contacts below)	MC407D or MC408D	MMC415D	MC425D	MC440D
 FEMALE INSERT (Order contacts below)	FC307D or FC308D	FC315D	FC325D	FC340D



Contacts Sold Separately

Crimp Tool

CAT. NO. WT80



Screw Terminal Wiring Adapter Block

SCREW TERMINAL WIRING ADAPTER BLOCK	—	—	—	40 + G
 MALE INSERT, GROUND L. 26–16 AWG (0.2–1.5mm ²)	—	—	—	MS440WAL
 FEMALE INSERT, GROUND L. 26–16 AWG (0.2–1.5mm ²)	—	—	—	FS340WAL
 FOOT ELEMENT MOUNTING 2x per adapter for DIN rail	—	—	—	FE807TB (2x needed)

Extraction Tool

CAT. NO. RT614







Wiring Adapter Insert for use with Panel Bases; allows single access direction panel-build wiring and easy terminal ID for service and testing.

ACCESSORIES:

ACCESSORIES:	CAT. NO.
Label Insert Clip	WAM-1
Strip blank	WAM1B
Strip Nos. 1–64	WAM1N64
Strip Letters A–Z	WAM1AZ

Contacts Selection Chart

CRIMP CONTACTS	WIRE AWG (MM ²)	IDENTIFICATION
	22+ AWG (0.14–0.37 mm ²)	1
	20 AWG (0.5 mm ²)	2
	18 AWG (0.75–1 mm ²)	3
	16 AWG (1.5 mm ²)	4
	14 AWG (2.5 mm ²)	5

For Optic Contacts

CRIMP CONTACTS	WIRE AWG (MM ²)	IDENTIFICATION
	18 AWG (0.75–1 mm ²)	3

For all Crimp Terminal "D" Inserts

FEMALE	MALE
FP22SD	MP22SD
FP20SD	MP20SD
FP18SD	MP18SD
FP16SD	MP16SD
FP14SD	MP14SD

FEMALE	MALE
FP18SD	MP18SD

See page G-58 for POF installation and tools info.

of Contacts + Ground Connection

Bases — Standard Mount				7 or 8	15	25	40	
SINGLE LEVER	DOUBLE LEVER	HOUSING	NPT ENTRY	LEVER LOCKING TYPE				
				SINGLE	SINGLE	SINGLE	SINGLE	DOUBLE
		Panel Base w/Cover Angled (no Cover)		PB303A(P)** PB403A PB503A(P)**	PB310A PB410A PB416A	PB316A	PB316 PB416	PB116E
		Box Base (no Cover)	1 X 3/8" 1 X 1/2" 2 X 1/2" 1 X 3/4" 1 X 1" 2 X 3/4" 2 X 1"	BB403A(P)**	BB410A BB510A	BB416A BB516A	BB416* BB416H100 BB516* BB516H100	BB016E* BB016EH100 BB116E* BB116EH100
		Box Base w/Cover	1 X 1/2" 2 X 1/2" 1 X 3/4" 1 X 1" 2 X 3/4" 2 X 1"		BB610A BB710A	BB616A BB716A	BB616*† BB616H100† BB716*† BB716H100†	

Base
Base to Hood

Hoods — Standard Mount *Body — "A" 3-16 Series standard Hoods include Gaskets: Bases and Special Hoods do not.*

		Side Entry	1 X 3/8" 1 X 1/2" 1 X 3/4" 1 X 1"	SH603A(P)**	SH610A SH710A	SH616A SH716A	TH816RC, TH216RC (RIBBON CABLE) SH616† SH716H†	SH016† SH116H
		Top Entry	1 X 3/8" 1 X 1/2" 1 X 3/4" 1 X 1"	TH803A(P)**	TH810A TH910A	TH816A TH916A	TH816† TH816H100	TH216† TH316H

Hoods
Hood to Coupler

Coupler Hoods — Inline *For Inline, Portable or Special Service Connections. Coupler Hoods mate to Standard Hoods ONLY.*

		Top Entry	1 X 3/8" 1 X 1/2" 1 X 3/4" 1 X 1"	CH803A(P)**	CH810A	CH816A	CH816RC, CH716ERC (RIBBON CABLE) CH816H CH916H	CH616EH CH716EH
--	--	-----------	--	-------------	--------	--------	--	--------------------

Coupler

Lever Hoods — Reverse Locking *Lever Hoods mate to Post Bases ONLY.*

		Side Entry w/Lever(s)	1 X 3/4" 1 X 1"				LH016E* LH116EH
		Top Entry w/Lever(s)	1 X 3/4" 1 X 1"				LH216E* LH316EH

Hoods
Hood to Base

Bases — with Access Cover *Post Bases accept Lever Hoods ONLY.*

		Panel Base+ Posts w/Cover					PB216†
		Box Base+ Posts w/Cover	1 X 3/4" 1 X 1" 2 X 3/4" 2 X 1"				BB216*† BB216H100† BB316*† BB316H100†

Bases

*Notes: Available in Standard or HIGH Profile "H" configurations. (-add suffix)
**(P) indicates glass-filled thermoplastic construction.

†Add "M" final suffix for metal cover option.

‡Both HIGH (H) and LOW (L) profile also available. (-add suffix)



50, 64 & 12B Contacts + Ground

Install to Matching Series Hood/Base



5D	64	80	12B
----	----	----	-----



Crimp Terminal Inserts

CRIMP TERMINAL INSERTS	50 + G	64 + G	80 + G	128 + G
 MALE INSERT (Order contacts below)	MC425D (2x)	MC464D	MC440D (2x)	MC464D (2x)
 FEMALE INSERT (Order contacts below)	FC325D (2x)	FC364D	FC340D (2x)	FC364D (2x)

Screw Terminal Wiring Adapter Block

SCREW TERMINAL WIRING ADAPTER BLOCK	—	64 + G	—	—
 MALE INSERT, GROUND L. 26–16 AWG (0.2–1.5mm ²)	—	MS464WAL	—	—
 FEMALE INSERT, GROUND L. 26–16 AWG (0.2–1.5mm ²)	—	FS364WAL	—	—
 MALE INSERT, GROUND L. 2X per adapter for DIN rail	—	FE807TB (2x needed)	—	—





Wiring Adapter Insert for use with Panel Bases; allows single access direction panel-build wiring and easy terminal ID for service and testing.

ACCESSORIES	CAT. NO.
Label Inserts	MP22SD
Strip Blank	MP20SD
Strip Nos. 1–64	MP18SD
Strip letters A–Z	MP16SD

Crimp Tool



Contacts Selection Chart

CRIMP CONTACTS	WIRE AWG (MM ²)	IDENTIFICATION
	22+ AWG (0.14–0.37 mm ²)	1
	20 AWG (0.5 mm ²)	2
	18 AWG (0.75–1 mm ²)	3
	16 AWG (1.5 mm ²)	4
	14 AWG (2.5 mm ²)	5

For all Crimp Terminal "D" Inserts

FEMALE	MALE
FP22SD	MP22SD
FP20SD	MP20SD
FP18SD	MP18SD
FP16SD	MP16SD
FP14SD	MP14SD

Extraction Tool







For Optic Contacts





CRIMP CONTACTS	WIRE AWG (MM ²)	IDENTIFICATION
	18 AWG (0.75–1 mm ²)	3

FEMALE	MALE
FP18SD	MP18SD



of Contacts + Ground Connection

Bases — Standard Mount				50	64	16	32	
SINGLE LEVER	DOUBLE LEVER	HOUSING	NPT ENTRY	LEVER LOCKING TYPE				
				DOUBLE	SINGLE	DOUBLE	DOUBLE	SINGLE
		Panel Base w/Cover		PB132A	PB324 PB424	PB124E	PB132	PB348
		Box Base (no Cover)	1 X ¾" 1 X 1" 2 X ¾" 2 X 1"	BB032A BB832A BB132A BB132A100	BB424* BB424H100 BB524* BB524H100	BB024E* BB024EH100 BB124E* BB124EH100	BB032 BB132	BB448 BB548
		Box Base w/Cover	1 X ¾" 1 X 1" 2 X ¾" 2 X 1"		BB642*† BB642H100† BB724*† BB724H100†			BB648 BB748



Hoods — Standard Mount

		Side Entry	1 X ¾" 1 X 1" 1 X 1¼"	SH032A SH132A	SH624** SH724**	SH024** SH124**	SH032 SH132	SH648 SH748
		Top Entry	1 X ¾" 1 X 1" 1 X 1¼" Ribbon CBL	TH232A TH332A	TH824** TH924 TH624RC†	TH224** TH324 TH424RC†	TH232 TH332	TH848 TH948



Coupler Hoods — Inline For Inline, Portable or Special Service Connections. Coupler Hoods mate to Standard Hoods ONLY.

		Top Entry	1 X ¾" 1 X 1" Ribbon CBL		CH824 CH924 CH824RC†	CH624E CH724E CH724ERC†	CH632 CH732	
---	---	-----------	--------------------------------	--	----------------------------	-------------------------------	----------------	--

Lever Hoods — Reverse Locking Lever Hoods mate to Post Bases ONLY.

		Side Entry w/Lever(s)	1 X ¾" 1 X 1"	LH032A LH132A		LH024E LH124E		
		Top Entry w/Lever(s)	1 X ¾" 1 X 1"	LH232A LH332A		LH224E LH324E		

Bases — with Access Cover Post Bases accept Lever Hoods ONLY.

		Panel + Posts w/Cover		PB232A		PB224†		
		Box + Posts w/Cover	1 X ¾" 1 X 1" 2 X ¾" 2 X 1"	BB232A BB232A100 BB332A BB332A100		BB224** BB224H100 BB324*† BB324H100		

*Notes: Available in Standard or HIGH Profile "H" configurations. (add suffix)
**Notes: Available in Standard or LOW Profile "L" configurations. (add suffix)

†Add "M" final suffix for metal cover option.
*See page I73 for ribbon cable kits.

Pos-E-Kon®

DD Series 10 Amps 600 VAC

24, 42, 72 Contacts + Ground

Install to Matching Series Hood/Base

24

42

72



Crimp Tool

CAT. NO. WT80





Extraction Tool



CAT. NO. RT614



Crimp Terminal Inserts

	SCREW TERMINAL INSERTS 24 + G	42 + G	72 + G	
	MALE INSERT (Order contacts below)	MC224DD	MC242DD	MC272DD
	FEMALE INSERT (Order contacts below)	FC124DD	FC142DD	FC172DD

Contacts Selection Chart

CRIMP CONTACTS	WIRE AWG (MM ²)	IDENTIFICATION
	22+ AWG (0.14–0.37 mm ²)	1
	20 AWG (0.5 mm ²)	2
	18 AWG (0.75–1 mm ²)	3
	16 AWG (1.5 mm ²)	4
	14 AWG (2.5 mm ²)	5

For all Crimp Terminal "DD" Inserts

FEMALE	MALE
FP22SD	MP22SD
FP20SD	MP20SD
FP18SD	MP18SD
FP16SD	MP16SD
FP14SD	MP14SD

Fiber Optic Contacts

CRIMP CONTACTS	WIRE GAUGE AWG (MM ²)
	Glass Fiber POF, Size 1 mm
	

FEMALE	MALE
FPF520	MPF530

See page G-58 for POF installation and tools info.

Pos-E-Kon® Pin and Sleeve Connectors



of Contacts + Ground Connection

Bases — Standard Mount				24	42	72		
SINGLE LEVER	DOUBLE LEVER	HOUSING	NPT ENTRY	LEVER LOCKING TYPE				
				SINGLE	SINGLE	DOUBLE	SINGLE	DOUBLE
		Panel Base		PB306**	PB310**	PB110E	PB316	PB116E
		w/Cover		PB406**	PB410**		PB416	
		Box Base (no Cover)	1 X 1/2" 1 X 3/4" 1 X 1" 2 X 1/2" 2 X 3/4" 2 X 1"	BB406 BB406H075 BB406H100 BB506 BB506H075 BB506H100	BB410 BB410H075 BB410H100 BB510 BB510H075 BB510H100	BB010E BB010EH075 BB010EH100 BB110E BB110EH075 BB110EH100	BB416* BB416H100 BB516* BB516H100	BB016E* BB016EH100 BB116E* BB116EH100
		Box Base	1 X 1/2" 1 X 3/4" 1 X 1" 2 X 1/2" 2 X 3/4" 2 X 1"	BB606** BB606H075** BB606H100** BB706** BB706H075** BB706H100**	BB610** BB610H075** BB610H100** BB710** BB710H075** BB710H100**		BB616* ** BB616H100** BB716* ** BB716H100**	

Base

Base to Hood

Hoods — Standard Mount

		Side Entry	1 X 1/2" 1 X 3/4" 1 X 1"	SH606 SH606H075 SH606H100	SH610 SH610H075 SH610H100	SH010 SH010H075 SH010H100	SH616 [†] SH716H [†]	SH016 [†] SH116H
		Top Entry	1 X 1/2" 1 X 3/4" 1 X 1" Ribbon CBL	TH806 TH806H075 TH806H100	TH810 TH810H075 TH810H100	TH210 TH210H075 TH210H100	TH816 [†] TH816H100 TH816RC [‡]	TH216 [†] TH316H TH216RC [‡]

Hoods

Hood to Coupler

Coupler Hoods — Inline *For Inline, Portable or Special Service Connections. Coupler Hoods mate to Standard Hoods ONLY.*

		Top Entry w/ Leveler(s)	1 X 1/2" 1 X 3/4" 1 X 1" Ribbon CBL	CH806 CH806H075 CH806H100	CH810 CH810H075 CH810H100	CH610E CH610EH075 CH610EH100	CH816H CH916H CH816RC [‡]	CH616EH CH716EH CH716ERC [‡]
--	--	-------------------------	--	---------------------------------	---------------------------------	------------------------------------	--	---

Coupler

Lever Hoods — Reversed Locked *Lever Hoods mate to Post Bases ONLY.*

	Side Entry w/Lever(s)	1 X 1/2" 1 X 3/4" 1 X 1"			LH010E LH010EH075 LH010EH100		LH016E* LH116EH
	Top Entry	1 X 1/2" 1 X 3/4" 1 X 1"			LH210E LH210EH075 LH210EH100		LH216E* LH316EH

Hoods

Hood to Base

Bases — with Access Cover *Post Bases accept Lever Hoods ONLY.*

	Panel + Posts w/Cover				PB210**		PB216**
	Box + Posts w/Cover	1 X 1/2" 1 X 3/4" 1 X 1" 2 X 1/2" 2 X 3/4" 2 X 1"			BB210** BB210H075** BB210H100** BB310** BB310H075** BB310H100**		BB216* ** BB216H100** BB316* ** BB316H100**

Bases

* Notes: Available in Standard or HIGH Profile "H" configurations. (-add suffix)
** Add "M" final suffix for metal cover option.

[†] Both HIGH (H) and LOW (L) profile also available. (-add suffix)
[‡] See page G-57 for ribbon cable kits.

Pos-E-Kon®

DD Series 10 Amps 600 VAC

108, 144 & 216 Contacts + Ground

Install to Matching Series Hood/Base



Pos-E-Kon® Pin and Sleeve Connectors

Crimp Tool

CAT. NO. WT80





Extraction Tool

CAT. NO. RT614



Crimp Terminal Inserts

CRIMP TERMINAL INSERTS	108 + G	144 + G	216 + G
 MALE INSERT (Order contacts below)	MC208DD	MC272DD+ MC244DD	MC208DD+ MC216DD
 FEMALE INSERT (Order contacts below)	FC108DD	FC172DD+ FC144DD	FC108DD+ FC116DD

Contacts Selection

For all Crimp Terminal "DD" Inserts

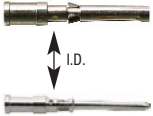



CRIMP CONTACTS	WIRE GAUGE AWG (MM ²)	IDENTIFICATION	FEMALE	MALE
	22+ AWG (0.14–0.37 mm ²)	1	FP22SD	MP22SD
	20 AWG (0.5 mm ²)	2	FP20SD	MP20SD
	18 AWG (0.75–1 mm ²)	3	FP18SD	MP18SD
	16 AWG (1.5 mm ²)	4	FP16SD	MP16SD
	14 AWG (2.5 mm ²)	5	FP14SD	MP14SD

Fiber Optic Contacts

CRIMP CONTACTS	WIRE GAUGE AWG (MM ²)	FEMALE	MALE
	Glass Fiber POF, Size 1 mm	FPF520	MPF530





See page G-58 for POF installation and tools info.

of Contacts + Ground Connection

Bases — Standard Mount				108	144	216	
SINGLE LEVER	DOUBLE LEVER	HOUSING	NPT ENTRY	LEVER LOCKING TYPE			
				SINGLE	DOUBLE	DOUBLE	SINGLE
		Panel Base w/Cover		PB324 PB424 [†]	PB124E	PB132	PB348 PB448
		Box Base (no Cover)	1 X ¾" 1 X 1" 2 X ¾" 2 X 1"	BB424* BB424H100 BB524* BB524H100	BB024E* BB024EH100 BB124E* BB124EH100	BB032 BB132	BB448 BB548
		Box Base w/Cover	1 X ¾" 1 X 1" 2 X ¾" 2 X 1"	BB624* [†] BB624H100 [†] BB724* [†] BB724H100 [†]			BB648 BB748



Base
Base to Hood

Hoods — Standard Mount

		Side Entry	1 X ¾" 1 X 1" 1 X 1¼"	SH624** SH724**	SH024** SH124**	SH032 SH132 SH132-125	SH648 SH748
		Top Entry	1 X ¾" 1 X 1" 1 X 1¼" Ribbon Cbl	TH824** TH924** TH624RC [‡]	TH224** TH324** TH424RC [‡]	TH232 TH332 TH332-125	TH848 TH948



Hoods
Hood to Coupler

Coupler Hoods — Inline *For Inline, Portable or Special Service Connections. Coupler Hoods mate to Standard Hoods ONLY.*

		Top Entry	1 X ¾" 1 X 1" Ribbon Cbl	CH824 CH924 CH824RC [‡]	CH624E CH724E CH724ERC [‡]	CH632 CH732	
---	---	-----------	--------------------------------	--	---	----------------	--



Coupler

Lever Hoods — Reverse Locking *Lever Hoods mate to Post Bases ONLY.*

	Side Entry w/Lever(s)	1 X ¾" 1 X 1"		LH024E LH124E		
	Top Entry w/Lever(s)	1 X ¾" 1 X 1"		LH224E LH324E		

Hoods
Hood to Base

Bases — with Access Cover *Post Bases accept Lever Hoods ONLY.*

	Panel Base w/Posts + Cover			PB224 [†]		
	Box Base w/Posts + Cover	1 X ¾" 1 X 1" 2 X ¾" 2 X 1"		BB224* [†] BB224H100 BB324* [†] BB324H100		

Bases

*Notes: Available in Standard or HIGH Profile "H" configurations. (-add suffix)

† Add "M" final suffix for metal cover option.

**Notes: Available in Standard or LOW Profile "L" configurations. (-add suffix)

‡ See page G-57 for ribbon cable kits.

Pos-E-Kon®

K Series 80 + 16 Amps 600 VAC

4 @80A + 8 @16A
8 @80A + 16 @16A
Contacts + Ground



Install to Matching Series Hood/Base

4 @80A +
8 @16A + G

8 @80A +
16 @16A + G



Screw Terminal Contact Carrier Inserts

	SCREW TERMINAL CONTACT CARRIER INSERTS	4 @80A+ 8 @16A+G	8 @80A+ 16 @16A+G
	MALE – PINS	MS212K	MS212K (x2)
	FEMALE – SLEEVES	FS112K	FS112K (x2)

WIRING NOTE: To 6 AWG (16mm²) 80A Contacts
To 14 AWG (2.5mm²) 16A Contacts

Pos-E-Kon® Pin and Sleeve Connectors















Thomas & Betts

United States
Tel: 901.252.8000
800.816.7809
Fax: 901.252.1354

Technical Services
Tel: 888.862.3289

K Series 80 + 16 Amps 600 VAC

of Contacts + Ground Connection

Bases — Standard Mount				K-12		K-24	
				4 @80A + 8 @16A + G		8 @80A + 16 @16A + G	
SINGLE LEVER	DOUBLE LEVER	HOUSING	NPT ENTRY	LEVER LOCKING TYPE			
				SINGLE	DOUBLE	SINGLE	
		Panel Base w/Cover		PB324 PB424	PB124E	PB348	
		Box Base (no Cover)	1 X 3/4" 1 X 1" 2 X 3/4" 2 X 1"	BB424* BB424H100 BB524* BB524H100	BB024E* BB024EH100 BB124E* BB124EH100	BB448 BB548	
		Box Base w/Cover	1 X 3/4" 1 X 1" 2 X 3/4" 2 X 1"	BB6241* BB624H1001 BB7241* BB724H1001		BB648 BB748	
Hoods — Standard Mount <i>*Plastic body — "A" 3-16 Series standard Hoods include Gaskets: Bases and Special Hoods do not.</i>							
		Side Entry	1 X 3/4" 1 X 1" 1 X 1 1/4"	SH624** SH724**	SH024** SH124**	SH648 SH748	
		Top Entry	1 X 3/4" 1 X 1" 1 X 1 1/4"	TH824** TH924	TH224** TH324	TH848 TH948	
Coupler Hoods — Inline <i>For Inline, Portable or Special Service Connections. Coupler Hoods mate to Standard Hoods ONLY.</i>							
		Top Entry	1 X 3/4" 1 X 1"	CH824 CH924	CH624E CH724E		
Lever Hoods — Reverse Locking <i>Lever Hoods mate to Post Bases ONLY.</i>							
		Side Entry w/Lever(s)	1 X 3/4" 1 X 1"		LH032A LH132A		
		Top Entry w/Lever(s)	1 X 3/4" 1 X 1"		LH232A LH332A		
Bases — with Access Cover <i>Post Bases accept Lever Hoods ONLY.</i>							
		Panel Base w/Posts + Cover			PB224†		
		Box Base w/Posts + Cover	1 X 3/4" 2 X 3/4"		BB224* BB324*		

* Notes: Available in Standard or HIGH Profile "H" configurations. (add suffix)

** Notes: Available in Standard or LOW Profile "L" configurations. (add suffix)

† Add "M" final suffix for metal cover option.

3, 6, 10, 16, 20, 26 & 32 Contacts +
Control Contacts & Ground



Install to Matching Series Hood/Base

3 + G + 2 CONTROL



6 + G + 2 CONTROL



Screw Terminal Inserts

SCREW TERMINAL INSERTS	3 + G + 2 CONTROL	6 + G + 2 CONTROL
 <p>MALE – PINS 20–14 AWG (0.5–2.5 mm²)</p>	MS203V	MS206V
 <p>FEMALE – SLEEVES 20–14 AWG (0.5–2.5 mm²)</p>	FS103V	FS106V

Crimp Terminal Inserts

CRIMP TERMINAL INSERTS	3 + G + 2 CONTROL	6 + G + 2 CONTROL
 <p>MALE INSERT (Order contacts below)</p>	MC403V	MC406V
 <p>FEMALE INSERT (Order contacts below)</p>	FC303V	FC306V



Use small blade screwdriver to push wire entry tab in for easy contact removal.

Crimp Tool

CAT. NO.





WT611TB



CONTROL CONTACTS:

MAKE LAST,
BREAK FIRST





Contacts Selection

CRIMP CONTACTS	WIRE AWG (MM ²)	IDENTIFICATION
	20 AWG (0.5 mm ²)	No Groove
	18 AWG (0.75–1 mm ²)	1 Groove
	16 AWG (1.5 mm ²)	2 Grooves
	14 AWG (2.5 mm ²)	3 Grooves
	12 AWG (4.0 mm ²)	No Groove





For "V" Series

FEMALE	MALE	SWITCH/CONTROL
FP2000	MP2000	—
FP1800	MP1800	CP1800
FP1600	MP1600	CP1600
FP1400	MP1400	CP1400
FP1200	MP1200	—

of Contacts + Ground Connection

Bases — Standard Mount				3 + G + 2 Control		6 + G + 2 Control	
SINGLE LEVER	DOUBLE LEVER	HOUSING	NPT ENTRY	LEVER LOCKING TYPE			
				SINGLE	DOUBLE	SINGLE	DOUBLE
		Panel Base		PB303V	PB103EV	PB306V	PB106EV
		w/Cover		PB403V	—	PB406V	—
		Box Base (no Cover)	1 X 1/2"	BB403V	BB003EV	—	—
			1 X 3/4"	—	—	BB406V	BB006EV
		Box Base w/Cover	2 X 1/2"	BB503V	BB103EV	—	—
			1 X 1/2"	BB603V*	—	BB506V	BB106EV
			1 X 3/4"	—	—	BB606V*	—
			2 X 1/2"	BB703V*	—	BB706V*	—
			2 X 3/4"	—	—	BB706V*	—



Hoods — Standard Mount

		Side Entry	1 X 1/2"	SH603V	SH003V	—	—
			1 X 3/4"	—	—	SH606V	SH006V
		Top Entry	1 X 1/2"	TH803V	TH203V	—	—
			1 X 3/4"	—	—	TH806V	TH206V



Coupler Hoods — Inline For Inline, Portable or Special Service Connections. Coupler Hoods mate to Standard Hoods ONLY.

		Top Entry	1 X 1/2"	CH803V	CH603EV	—	—
			1 X 3/4"	—	—	CH806V	CH606EV

Lever Hoods — Reverse Locking Lever Hoods mate to Post Bases ONLY.

	Side Entry w/Lever(s)	1 X 3/4"		LH003EV		LH006EV
	Top Entry w/Lever(s)	1 X 3/4"		LH203EV		LH206EV

Bases — with Access Cover Post Bases accept Lever Hoods ONLY.

	Panel Base+ Posts w/Cover		—	PB203V*	—	PB206V*
	Box Base+ Posts w/Cover	1 X 1/2"	—	BB303V*	—	—
		1 X 3/4"	—	—	—	BB206V*
		2 X 1/2"	—	BB203V*	—	—
		2 X 3/4"	—	—	—	BB306V*

* Add "M" final suffix for metal cover option.



3, 6, 10, 16, 20, 26 & 32 Contacts
+2 Control Contacts & Ground

Install to Matching Series Hood/Base



10 + G + 2 Control	16 + G + 2 Control	20 + G + 2 Control	26 + G + 2 Control	32 + G + 2 Control
-----------------------	-----------------------	-----------------------	-----------------------	-----------------------



Screw Terminal Inserts

SCREW TERMINAL INSERTS	10 + G +2 CONTROL	16 + G +2 CONTROL	20 + G +2 CONTROL	26 + G +2 CONTROL	32 + G +2 CONTROL
 <p>MALE – PINS 20–14 AWG (0.5–2.5 mm²)</p>	MS210V	MS216V	MS210V	MS210V+ MS216V	2x MS216V
 <p>FEMALE – SLEEVES 20–14 AWG (0.5–2.5 mm²)</p>	FS110V	FS116V	FS110V	FS110V+ FS116V	2x FS116V

Crimp Terminal Inserts

CRIMP TERMINAL INSERTS	10 + G +2 CONTROL	16 + G +2 CONTROL	20 + G +2 CONTROL	26 + G +2 CONTROL	32 + G +2 CONTROL
 <p>MALE INSERT (Order contacts below)</p>	MC410V	MC416V	MC410V x2	MC410V+ MC416V	2x MC416V
 <p>FEMALE INSERT (Order contacts below)</p>	FC310V	FC316V	FC310V x2	FC310V+ FC316V	2x FC316V



Use small blade screwdriver to push wire entry tab in for easy contact removal.

Crimp Tool





CAT. NO.

WT611TB







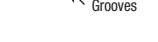





Contacts Selection

For all "V" Inserts

CRIMP CONTACTS	WIRE AWG (MM ²)	IDENTIFICATION	FEMALE	MALE	SWITCH/CONTROL
	20 AWG (0.5 mm ²)	No Groove	FP2000	MP2000	—
	18 AWG (0.75–1 mm ²)	1 Groove	FP1800	MP1800	CP1800
	16 AWG (1.5 mm ²)	2 Grooves	FP1600	MP1600	CP1800
	14 AWG (2.5 mm ²)	3 Grooves	FP1400	MP1400	CP1400
	12 AWG (4.0 mm ²)	No Groove	FP1200	MP1200	—

Grooves

of Contacts + Ground Connection

Bases — Standard Mount				V10: (10 + G) or (16 + G) + 2 Control	V20: (20 + G) or (26 + G) or (32 + G) + 2 Control	
SINGLE LEVER	DOUBLE LEVER	HOUSING	NPT ENTRY	LEVER LOCKING TYPE		
				DOUBLE	SINGLE	
		Panel Base		PB110EV	PB348	Base
		w/Cover			PB448	
		Box Base (no Cover)	1 X ¾"	BB010EV	BB448	Base to Hood
			1 X 1"	BB110EV	BB548	
		Box Base (no Cover)	2 X ¾"		BB648	Base to Hood
			2 X 1"		BB748	
Hoods — Standard Mount <i>*Plastic body — "A" 3-16 Series standard Hoods include Gaskets: Bases and Special Hoods do not.</i>						
		Side Entry	1 X ¾"	SH010V SH010V100	SH648 SH748	Hoods
			1 X 1"			
		Top Entry	1 X ¾"	TH210V	TH848 TH948	Hood to Coupler
			1 X 1"			
		Top Entry	1 X ¾"	CH610EV CH610EV100 CH610EV125		Coupler
			1 X 1"			
		Side Entry w/Lever(s)	1 X ¾"	LH010EV		Hoods
		Top Entry w/Lever(s)	1 X ¾"	LH210EV LH210EV100		Hood to Base
			1 X 1"			
Bases — with Access Cover <i>Post Bases accept Lever Hoods ONLY.</i>						
		Panel Base+ w/Posts + Cover		PB210V ¹		Bases
		Box Base+ w/Posts + Cover	1 X ¾" 2 X ¾"	BB210V ¹ BB310V ¹		Bases

¹ Add "M" final suffix for metal cover option.



6, 10, 16 & 24 Contacts + Ground

Install to Matching Series Hood/Base

6	10	16	24
---	----	----	----



Screw Terminal Inserts

*SCREW TERMINAL INSERTS		6 + G	10 + G	16 + G	32 + G
	MALE – PINS 20–14 AWG (0.5–2.5 mm ²)	MS206T	MS210T	MS216T	MS224T
		FS106T	FS110T	FS116T	FS124T

**inserts may be dark brown or gray in color*

- High Temp 200°C Components
- Corrosion Resistant Housings

T Series Benefits:

- High temp 200°C rated inserts
- Silicone Viton® seals for molded edge gaskets*
- Corrosion-resistant copper-free aluminum housings with special finish
- UL94V-0 ergonomic thermoplastic handles
- Electro-static epoxy powder coated finish

**Viton® is a trademark of DuPont Performance Elastomers.*

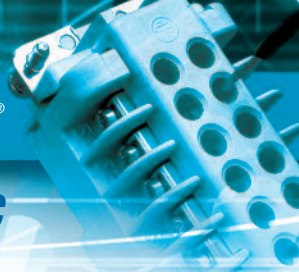

of Contacts + Ground Connection

Bases — Standard Mount

				6	10	16	32
SINGLE LEVER	DOUBLE LEVER	HOUSING	NPT ENTRY	LEVER LOCKING TYPE			
				SINGLE	DOUBLE	DOUBLE	DOUBLE
		Panel Base		PB306T	PB110T	PB116T	PB124T
		Box Base (no Cover)	1 X 1/2"	BB406T	BB010T	BB016T	BB024T
			1 X 3/4" 2 X 1/2" 2 X 3/4"	BB506T	BB110T	BB116T	BB124T

Base

Base to Hood

Hoods — Standard Mount

		Side Entry	1 X 1/2" 1 X 3/4" 1 X 1"	SH606T	SH010T	SH016T	SH024T SH124T
		Top Entry	1 X 1/2" 1 X 3/4" 1 X 1"	TH806T	TH210T	TH216T	TH224T TH324T

Hoods

Hood to Coupler

Coupler Hoods — Inline *For Inline, Portable or Special Service Connections. Coupler Hoods mate to Standard Hoods ONLY.*

		Top Entry	1 X 1/2" 1 X 3/4" 1 X 1"	CH806T	CH610T	CH616T CH716T	CH624T CH724T
--	--	-----------	--------------------------------	--------	--------	------------------	------------------

Coupler

NOTE: Hoods and Bases are black colored to denote special T series.

A Series

Specifications

DIN VDE 0627/86	DIN VDE 0627/86
DIN VDE 0110/02.79	DIN VDE 0110/02.79
DIN VDE 0110-1/04.97	DIN VDE 0110-1/04.97
IEC 60-664-1, DIN/IEC 512	IEC 60-664-1, DIN/IEC 512

Approvals



MEIE, EZU, SEV

Inserts

Contacts (+Ground)	3,4,10,16,32 (2x16)
Working current	A3, A4 @ 10A max. A10–A32 @ 16A max.
Rated Voltage	600Vac
Test Voltage	4 kV eff.
Pollution Degree	3
Material	Glass Filled Thermoplastic
Temperature Range	-40C/-40F to +125C /+257 °F
Flammability	UL94 V-0

Contacts

Material	Solid drilled Copper alloy
Surface	Hard Silver Plated Hard Gold Plated available
Contact Resistance	≤ 1 milliohm
Screw Terminals:	Wire AWG:
+ with Wire Protection	20–14 AWG (0.5–2.5mm)
Crimp Terminals:	20–12 AWG (0.5–2.5mm)

Housings

Materials:	Die Cast Aluminum alloy
(EPDM Seal Gaskets)	Epoxy Powder Coat Finish
Locking Mechanisms:	@ A3, 4, 10, 16
> Single Locking Levers	Steel, Zinc & Chrome Plated @ A32
> Double Locking Levers	Steel, Zinc & Chrome Plated

Temperature Range	-40C/-40F to +125C /+257 °F
Internal Protection	A3,4: IP44 A10,16,32: IP65 per DIN VDE 0470, IEC 529

Thermal Capacity per DIN/IEC 512

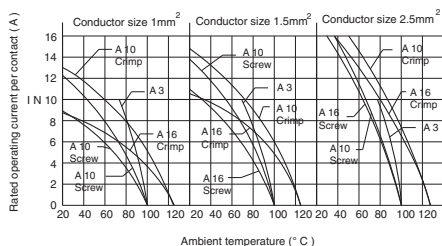

B Series

Specifications

DIN VDE 0627/86	DDIN VDE 0110/02.79
DDIN VDE 0110/02.79	DIN VDE 0110-1/04.97
DIN VDE 0110-1/04.97	IEC 60-664-1, DIN/IEC 512

Approvals



MEIE, EZU, SEV

Inserts

Contacts (+Ground)	6,10,16,24, 32 (2x16), 48 (2x24)
Working current	16A max.
Rated Voltage	600Vac
Test Voltage	3 kV eff.
Pollution Degree	3
Material	Glass Filled Thermoplastic
Temperature Range	-40C/-40F to +125C /+257 °F
Flammability	UL94 V-0

Contacts

Material	Solid drilled Copper alloy
Surface	Hard Silver Plated Hard Gold Plated available
Contact Resistance	≤ 1 milliohm
Screw Terminals:	Wire AWG:
+ with Wire Protection	20–14 AWG (0.5–2.5mm)
Crimp Terminals:	20–12 AWG (0.5–2.5mm)

Housings

Materials:	Die Cast Aluminum alloy
(EPDM Seal Gaskets)	Epoxy Powder Coat Finish
Locking Mechanisms:	@ B6, 10, 24, 32, 48
> Single Locking Levers	Steel, Zinc & Chrome Plated @ B10, 16, 24 Stainless Steel w/ high impact Thermoplastic Split Grips @ 32
> Double Locking Levers	Steel, Zinc & Chrome Plated
> Double Locking Levers	Steel, Zinc & Chrome Plated

Temperature Range	-40C/-40F to +125C /+257 °F
Internal Protection	IP65 Locked Positions per DIN VDE 0470, IEC 529

Thermal Capacity per DIN/IEC 512

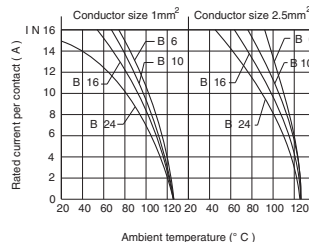

C Series

Specifications

DIN VDE 0627/86	DIN VDE 0627/86
DIN VDE 0110/02.79	DIN VDE 0110/02.79
DIN VDE 0110-1/04.97	DIN VDE 0110-1/04.97
IEC 60-664-1, DIN/IEC 512	IEC 60-664-1, DIN/IEC 512

Approvals

	MEIE, EZU, SEV
---	----------------

Inserts

Contacts (+Ground)	6, 12 (2 x 6)
Working current	35A
Rated Voltage	600Vac
Test Voltage	3 kV eff.
Pollution Degree	3
Material	Glass Filled Thermoplastic
Temperature Range	-40C/-40F to +125C /+257 °F
Flammability	UL94 V-0

Contacts

Material	Solid drilled Copper alloy
Surface	Hard Silver Plated Hard Gold Plated available
Contact Resistance	≤ 0.5 milliohm
Screw Terminals:	Wire AWG:
+ with Wire Protection	20–10 AWG (0.5–6.0mm)
+ w/o Wire Protection	n/

Housings

Materials:	Die Cast Aluminum alloy
(EPDM Seal Gaskets)	Epoxy Powder Coat Finish
Locking Mechanisms:	
> Single Locking Levers	@ C6, 12 Steel, Zinc & Chrome Plated
> Double Locking Levers	@ C6 Stainless Steel w/high impact Thermoplastic Split Grips
> Double Locking Levers	@ C12 Steel, Zinc & Chrome Plated
Temperature Range	-40C/-40F to +125C /+257 °F
Internal Protection	IP65 Locked Positions per DIN VDE 0470, IEC 529

Thermal Capacity

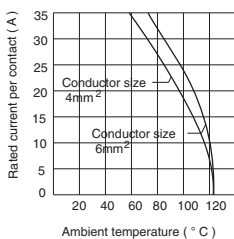

D Series

Specifications

DIN VDE 0627/86	DIN 43652
DDIN VDE 0110/02.79	
DIN VDE 0110-1/04.97	
IEC 60-664-1, DIN/IEC 512	

Approvals

	MEIE, EZU, SEV
---	----------------

Inserts

Contacts (+Ground)	7, 8, 15, 25, 40, 50 (2x25)
Working current	64, 80 (2x40), 128 (2X64)
Rated Voltage	10A
Test Voltage	600Vac
Pollution Degree	4 kV eff.
Material	3
Temperature Range	Glass Filled Thermoplastic
Flammability	-40C/-40F to +125C /+257 °F
	UL94 V-0

Contacts

Material	Solid drilled Copper alloy
Surface	Hard Silver Plated Hard Gold Plated available
Contact Resistance	≤ 3 milliohm
Crimp Terminals:	Wire AWG:
	26–14 AWG (0.1422.5mm)
	> Glass Fibre optic Cable:
	POF {0} 1MM

Housings

Materials:	Die Cast Aluminum alloy
(EPDM Seal Gaskets)	Epoxy Powder Coat Finish
Locking Mechanisms:	
> Single Locking Levers	@ D7, 8, 15, 25, 40, 64, 128 Steel, Zinc & Chrome Plated
> Double Locking Levers	@ D40, 64 Stainless Steel w/ high impact Thermoplastic Split Grips
> Double Locking Levers	@ D50, 80 Steel, Zinc & Chrome Plated
Temperature Range	-40C/-40F to +125C /+257 °F
Internal Protection	IP65 Locked Positions per DIN VDE 0470, IEC 529

Thermal Capacity

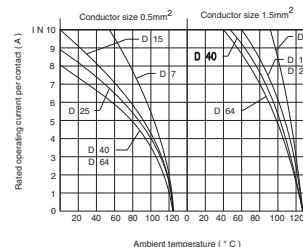

DD Series

Specifications

DIN VDE 0627/86
 DIN VDE 0110/02.79
 DIN VDE 0110-1/04.97
 IEC 60-664-1, DIN/IEC 512

Approvals



MEIE, EZU, SEV

Inserts

Contacts (+Ground)	24, 42, 72, 108, 144 (2x72)
Working current	216 (2x108) 10A
Rated Voltage	600Vac
Test Voltage	2 kV eff.
Pollution Degree	3
Material	Glass Filled Thermoplastic
Temperature Range	-40C/-40F to +125C /+257 °F
Flammability	UL94 V-0

Contacts

Material Solid drilled Copper alloy
Surface Hard Silver Plated
 Hard Gold Plated available

Contact Resistance ≤ 3 milliohm
Crimp Terminals: Wire AWG:
 26–14 AWG (0.14–2.5mm)
 POF (Ø) 1mm

> Glass Fibre Optic Cable:

Housings

Materials: Die Cast Aluminum alloy
(EPDM Seal Gaskets) Epoxy Powder Coat Finish

Locking Mechanisms:

- > Single Locking Levers @ DD24, 42, 72, 108, 216
Steel, Zinc & Chrome Plated
- > Double Locking Levers @ DD42, 72, 108
Stainless Steel w/high impact
Thermoplastic Split Grips
- > Double Locking Levers @ DD144
Steel, Zinc & Chrome Plated

Temperature Range -40C/-40F to +125C /+257 °F
Internal Protection IP65 Locked Positions
 per DIN VDE 0470, IEC 529

Thermal Capacity

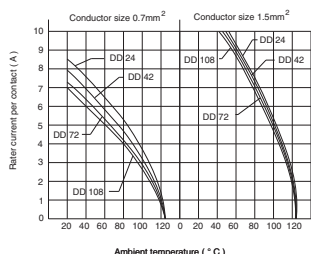

K Series

Specifications

DIN VDE 0627/86 VDE 0113/1.73-10.1.3
 DDIN VDE 0110/4
 VDE 0100/5.73-42a
 IEC 60-664-1, DIN/IEC 512

Approvals



MEIE, EZU, SEV

Inserts

Contacts (+Ground)	8 (16A) + 4 (80A) 16 (16A) + 8 (80A)
Working current	16A and 80A dual
Rated Voltage	600Vac
Test Voltage	2 kV eff.
Pollution Degree	3
Material	Glass Filled Thermoplastic
Temperature Range	-40C/-40F to +125C /+257 °F
Flammability	UL94 V-0

Contacts

Material Solid drilled Copper alloy
Surface Hard Silver Plated
 Hard Gold Plated available

Contact Resistance ≤ 1 milliohm
Screw Terminals: Wire AWG:
 + with Wire Protection: (16A)
 (80A contacts) 20–14 AWG (0.5–2.5mm)
 18–4 AWG (1.5–16.0mm)

Housings

Materials: Die Cast Aluminum alloy
(EPDM Seal Gaskets) Epoxy Powder Coat Finish

Locking Mechanisms:

- > Single Locking Levers @ K12, K24
Steel, Zinc & Chrome Plated
- > Double Locking Levers @ K12
Stainless Steel w/ high impact
Thermoplastic Split Grips

Temperature Range -40C/-40F to +125C /+257 °F
Internal Protection IP65 Locked Positions
 per DIN VDE 0470, IEC 529

V Series

Specifications

DIN VDE 0627/86
 DIN VDE 0110/02.79
 DIN VDE 0110-1/04.97
 IEC 60-664-1, DIN/IEC 512

Approvals



MEIE, EZU, SEV

Inserts

Contacts (+Ground)	3, 6, 10, 16, 20 (2x10) 26 (10+16), 32 (2x16).
Working current	16A max.
Rated Voltage	600Vac, Switch contacts 400 Vac
Test Voltage	3 kV eff.
Pollution Degree	3
Material	Glass Filled Thermoplastic
Temperature Range	-40C/-40F to +125C /+257 °F
Flammability	UL94 V-0

Contacts

Material Surface	Solid drilled Copper alloy Hard Silver Plated Hard Gold Plated available
Contact Resistance	≤ 1 milliohm
Screw Terminals:	Wire AWG:
+ with Wire Protection	20–14 AWG (0.5–2.5mm)
Crimp Terminals:	20–12 AWG (0.5–2.5mm)

Housings

Materials:	Die Cast Aluminum alloy
(EPDM Seal Gaskets)	Epoxy Powder Coat Finish
Locking Mechanisms:	
> Single Locking Levers	@ V3, 6, 10, 16, 20, 26, 32 Steel, Zinc & Chrome Plated
> Double Locking Levers	@ V3, 6, 10, 16 Stainless Steel w/high impact Thermoplastic Split Grips

Temperature Range	-40C/-40F to +125C /+257 °F
Internal Protection	IP65 Locked Positions per DIN VDE 0470, IEC 529

Thermal Capacity

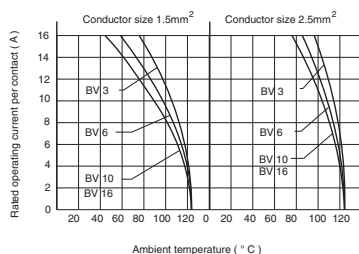

T Series

Specifications

DIN VDE 0627/86
 DDIN VDE 0110/02.79
 DIN VDE 0110-1/04.97
 IEC 60-664-1, DIN/IEC 512

Approvals



MEIE, EZU, SEV

Inserts

Contacts (+Ground)	6, 10, 16, 24
Working current	16A max.
Rated Voltage	600Vac, Switch contacts 400Vac
Test Voltage	3 kV eff.
Pollution Degree	3
Material	Hi-Temp Thermoplastic
Temperature Range	-40C/-40F to +200C /+392 °F
Flammability	UL94 V-0

Contacts

Material Surface	Solid drilled Copper alloy Hard Silver Plated Hard Gold Plated available
Contact Resistance	≤ 1 milliohm
Screw Terminals:	Wire AWG:
+ with Wire Protection	20–14 AWG (0.5–2.5mm)

Housings

Materials:	Copper-Free Die Cast Aluminum alloy
(Viton® Seal Gaskets)	Green Epoxy Powder Coating
Locking Mechanisms:	
> Single Locking Levers	@ T6 Stainless Steel, Black Coated
> Double Locking Levers	@ T10, 16, 24 Stainless Steel, with High Temp Thermoplastic Grips

Temperature Range	-40C/-40F to +200 °C /+392 °F
Internal Protection	IP65 Locked Positions per DIN VDE 0470, IEC 529

Thermal Capacity

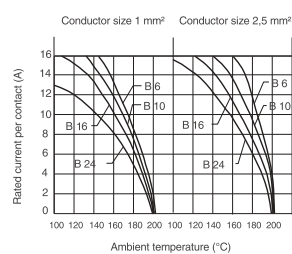

Mounting Dimensions for Double Lever Box Bases

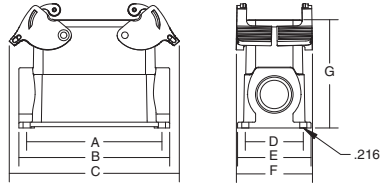

HOUSING SERIES				CAT. NO.	DIMENSIONS ARE IN INCHES / (MILLIMETRES)						
A, B, T, K	C, V	D	DD		A	B	C	D	E	F	G
A32	D50			BB_32A	3.70 / (94)	4.17 / (106)	5.04 / (128)	1.81 / (46)	2.20 / (56)	2.76 / (70)	3.40 / (86.5)
B10, T10	V3		DD42	BB_10E	3.23 / (82)	3.66 / (93)	4.33 / (110)	1.57 / (40)	2.05 / (52)	2.28 / (58)	2.05 / (52)
				BB_10EH	3.23 / (82)	3.66 / (93)	4.33 / (110)	1.77 / (45)	2.24 / (57)	2.28 / (58)	2.92 / (74)
B16, T16	C6, V6	D40	DD72	BB_16E	4.13 / (105)	4.61 / (117)	5.16 / (131)	1.77 / (45)	2.24 / (57)	2.28 / (58)	2.68 / (68)
				BB_16EH	4.13 / (105)	4.61 / (117)	5.16 / (131)	1.77 / (45)	2.24 / (57)	2.28 / (58)	3.31 / (84)
B24, T24, K12	V10, V16	D64	DD108	BB_24E	5.20 / (132)	5.67 / (144)	6.18 / (157)	1.77 / (45)	2.24 / (57)	2.28 / (58)	2.68 / (68)
				BB_24EH	5.20 / (132)	5.67 / (144)	6.18 / (157)	1.77 / (45)	2.24 / (57)	2.28 / (58)	3.31 / (84)
B32	C12	D80	DD144	BB_32E	4.41 / (112)	4.88 / (112)	5.28 / (134)	2.64 / (67)	3.20 / (81.5)	3.62 / (92)	2.83 / (72)

Mounting Dimensions for Single Lever Box Bases

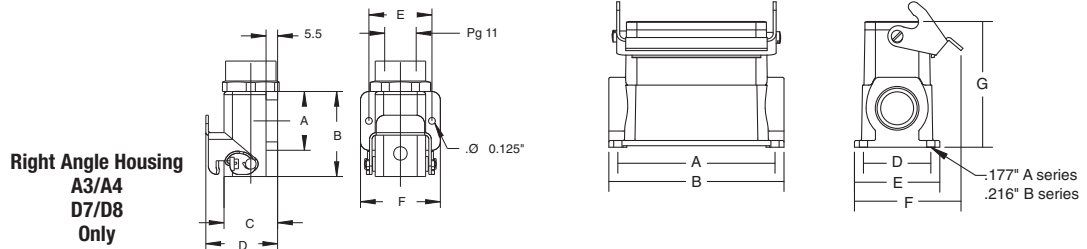

Right Angle Housing
A3/A4
D7/D8
Only

HOUSING SERIES				CAT. NO.	DIMENSIONS ARE IN INCHES / (MILLIMETRES)						
A, B, T, K	C, V	D	DD		A	B	C	D	E	F	G
A3, A4		D7, D8		BB403A(P)*	1.10 / (28)	1.59 / (40.5)	1.00 / (25.5)	1.42 / (36)	1.18 / (30)	1.50 / (38)	
A10		D15		BB_10A	1.89 / (48)	—	3.66 / (93)	1.57 / (40)	1.97 / (50)	2.32 / (59)	2.05 / (52)
A16		D25		BB_16A	2.52 / (64)	—	4.29 / (109)	1.57 / (40)	1.97 / (50)	2.32 / (59)	2.24 / (57)
B6, T6			DD24	BB_06	2.76 / (70)	3.31 / (84)	—	1.57 / (40)	2.05 / (52)	2.72 / (69)	2.05 / (52)
				BB_06H075	2.76 / (70)	3.31 / (84)	—	1.77 / (45)	2.24 / (57)	2.72 / (69)	2.92 / (74)
				BB_06H100	2.76 / (70)	3.31 / (84)	—	1.77 / (45)	2.24 / (57)	2.72 / (69)	2.92 / (74)
B10, T10	V3		DD42	BB_10	3.23 / (82)	3.66 / (93)	—	1.57 / (40)	2.05 / (52)	2.80 / (71)	2.05 / (52)
				BB_10H075	3.23 / (82)	3.66 / (93)	—	1.77 / (45)	2.24 / (57)	2.80 / (71)	2.92 / (74)
				BB_10H100	3.23 / (82)	3.66 / (93)	—	1.77 / (45)	2.24 / (57)	2.80 / (71)	2.92 / (74)
B16, T16	C6, V6	D40	DD72	BB_16	4.13 / (105)	4.61 / (117)	—	1.77 / (45)	2.24 / (57)	2.91 / (74)	2.68 / (68)
				BB_16H	4.13 / (105)	4.61 / (117)	—	1.77 / (45)	2.24 / (57)	2.91 / (74)	3.31 / (84)
B24, T24, K12	V10, V16	D64	DD108	BB_24	5.20 / (132)	5.67 / (144)	—	1.77 / (45)	2.24 / (57)	2.91 / (74)	2.68 / (68)
				BB_24H	5.20 / (132)	5.67 / (144)	—	1.77 / (45)	2.24 / (57)	2.91 / (74)	3.31 / (84)
B48, K24, V32	V20, V26	D128	DD216	BB_48	4.37 / (111)	5.71 / (145)	—	4.17 / (106)	4.72 / (120)	6.18 / (157)	3.94 / (100)

*Suffix: A - Aluminum, P - Plastic



Mounting Dimensions for Double Lever Panel Bases

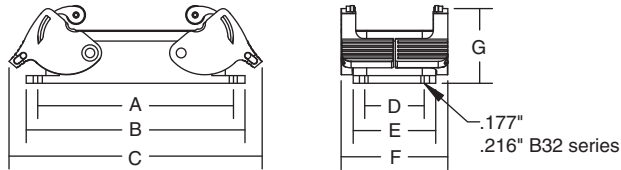

HOUSING SERIES				CAT. NO.	DIMENSIONS ARE IN INCHES / (MILLIMETRES)						
A, B, T, K	C, V	D	DD		A	B	C	D	E	F	G
A32	D50			PB132A	3.62 / (92)	4.02 / (102)	5.04 / (128)	1.65 / (28)	2.24 / (57)	2.76 / (70)	1.10 / (28)
B10, T10	V3		DD42	PB110E	3.27 / (83)	3.66 / (93)	4.33 / (110)	1.26 / (32)	1.69 / (43)	2.28 / (58)	1.06 / (27)
B16, T16	C6, V6	D40	DD72	PB116E	4.05 / (103)	4.49 / (114)	5.16 / (131)	1.26 / (32)	1.69 / (43)	2.28 / (58)	1.06 / (27)
B24, T24,	V10, V16	D64	DD108	PB124E	5.12 / (130)	5.51 / (140)	6.19 / (157)	1.26 / (32)	1.69 / (43)	2.28 / (58)	1.06 / (27)
B32	C12	D80	DD144	PB132E	4.33 / (110)	4.88 / (124)	5.28 / (134)	2.56 / (65)	3.11 / (79)	3.62 / (92)	1.18 / (30)

Mounting Dimensions for Single Lever Panel Bases

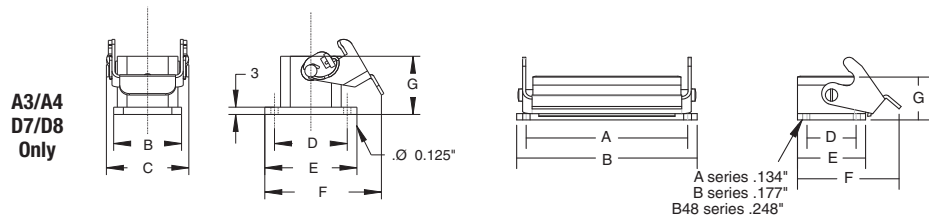

HOUSING SERIES				CAT. NO.	DIMENSIONS ARE IN INCHES / (MILLIMETRES)						
A, B, T, K	C, V	D	DD		A	B	C	D	E	F	G
A3, A4		D7, D8		PB303A (P)*	-	1.10 / (28)	1.34 / (34)	1.18 / (30)	1.50 / (38)	1.67 / (42.5)	.95 / (24)
				PB403A (P)*	-	1.10 / (28)	1.38 / (35)	1.18 / (30)	1.58 / (40)	1.85 / (47)	.95 / (24)
				PB503A (P)	1.10 / (28)	1.59 / (40.5)	1.00 / (25.5)	1.42 / (36)	1.18 / (30)	1.50 / (38)	
A10		D15		PB310A	2.76 / (70)	3.19 / (81)	-	.68 / (17.5)	1.20 / (30.5)	1.93 / (49)	1.02 / (26)
A16		D25		PB410A	2.76 / (70)	3.19 / (81)	-	.68 / (17.5)	1.20 / (30.5)	2.95 / (75)	1.02 / (26)
				PB316A	3.39 / (86)	3.78 / (96)	-	.68 / (17.5)	1.20 / (30.5)	1.93 / (49)	1.02 / (26)
B6, T6			DD24	PB416A	3.39 / (86)	3.78 / (96)	-	.68 / (17.5)	1.20 / (30.5)	2.95 / (75)	1.02 / (26)
				PB306	2.76 / (70)	3.15 / (80)	-	1.26 / (32)	1.69 / (43)	2.56 / (65)	1.06 / (27)
B10, T10	V3		DD42	PB406	2.76 / (70)	3.15 / (80)	-	1.26 / (32)	1.69 / (43)	3.54 / (90)	1.06 / (27)
				PB310	3.27 / (83)	3.66 / (93)	-	1.26 / (32)	1.69 / (43)	2.64 / (67)	1.06 / (27)
B16, T16	C6, V6	D40	DD72	PB410	3.27 / (83)	3.66 / (93)	-	1.26 / (32)	1.69 / (43)	3.62 / (92)	1.06 / (27)
				PB316	4.06 / (103)	4.49 / (114)	-	1.26 / (32)	1.69 / (43)	2.64 / (67)	1.06 / (27)
B24, T24,	V10, V16	D64	DD108	PB416	4.06 / (103)	4.49 / (114)	-	1.26 / (32)	1.69 / (43)	3.62 / (92)	1.06 / (27)
				PB324	5.12 / (130)	5.51 / (140)	-	1.26 / (32)	1.69 / (43)	2.64 / (67)	1.06 / (27)
B48, K24,	V20, V26	D128	DD216	PB424	5.12 / (130)	5.51 / (140)	-	1.26 / (32)	1.69 / (43)	3.62 / (92)	1.06 / (27)
				PB348	5.83 / (148)	6.50 / (165)	-	2.76 / (70)	3.54 / (90)	6.18 / (157)	1.61 / (41)
V32				PB448	5.83 / (148)	6.50 / (165)	-	2.76 / (70)	3.54 / (90)	6.81 / (173)	1.61 / (41)

*Suffix: A - Aluminum, P - Plastic

Mounting Dimensions for Screw and Crimp Terminal Inserts

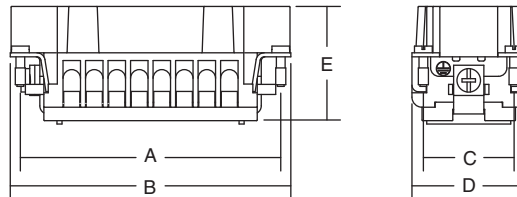

HOUSING SERIES				MATING	DIMENSIONS ARE IN INCHES / (MILLIMETRES)				
A, B, T, K	C, V	D	DD		A	B	C	D	E
A3, A4		D7, D8		BOTH	—	.83 / (21)	—	.83 / (21)	.98 / (25)
				FEMALE	—	.83 / (21)	—	.83 / (21)	1.25 / (31.8)
				MALE	—	.83 / (21)	—	.83 / (21)	1.19 / (30.2)
A10		D15		FEMALE	1.95 / (49.5)	2.22 / (56.5)	.63 / (16)	1.34 / (34)	1.14 / (29)
				MALE	1.95 / (49.5)	2.22 / (56.5)	.63 / (16)	1.34 / (34)	1.26 / (32)
A16		D25		FEMALE	2.60 / (66)	2.87 / (73)	.63 / (16)	1.34 / (34)	1.14 / (29)
				MALE	2.60 / (66)	2.87 / (73)	.63 / (16)	1.34 / (34)	1.26 / (32)
A32		D50		FEMALE	2.60 / (66)	2.87 / (73)	.63 / (16) x 2	1.34 / (34)	1.14 / (29)
				MALE	2.60 / (66)	2.87 / (73)	.63 / (16) x 2	1.34 / (34)	1.26 / (32)
B6, T6			DD24	FEMALE	1.73 / (44)	2.01 / (51)	1.063 / (27)	1.34 / (34)	1.46 / (37)
				MALE	1.73 / (44)	2.01 / (51)	1.063 / (27)	1.34 / (34)	1.38 / (35)
B10, T10	V3		DD42	FEMALE	2.24 / (57)	2.52 / (64)	1.063 / (27)	1.34 / (34)	1.46 / (37)
				MALE	2.24 / (57)	2.52 / (64)	1.063 / (27)	1.34 / (34)	1.38 / (35)
B16, T16	C6, V6	D40	DD72	FEMALE	3.05 / (77.5)	3.33 / (84.5)	1.063 / (27)	1.34 / (34)	1.48 / (37.5)
				MALE	3.05 / (77.5)	3.33 / (84.5)	1.063 / (27)	1.34 / (34)	1.40 / (35.5)
B24, T24, K12	V10, V16	D64	DD108	FEMALE	4.09 / (104)	4.37 / (111)	1.063 / (27)	1.34 / (34)	1.48 / (37.5)
				MALE	4.09 / (104)	4.37 / (111)	1.063 / (27)	1.34 / (34)	1.40 / (35.5)
B32	C12	D80	DD144	FEMALE	3.05 / (77.5)	3.33 / (84.5)	1.063 / (27) x 2	1.34 / (34)	1.48 / (37.5)
				MALE	3.05 / (77.5)	3.33 / (84.5)	1.063 / (27) x 2	1.34 / (34)	1.40 / (35.5)
B48, K24	V20, V26, V32	D128	DD216	FEMALE	4.09 / (104)	4.37 / (111)	1.063 / (27) x 2	1.34 / (34)	1.48 / (37.5)
				MALE	4.09 / (104)	4.37 / (111)	1.063 / (27) x 2	1.34 / (34)	1.40 / (35.5)



Insert Screw Torque Specifications

SERIES	SCREW LOCATION	UNIT OF MEASURE SCREWDRIVER	POZI-DRIVE POINT SCREWDRIVER	STD. STRAIGHT-BLADE
A3 A4	wire termination screw	Newton meters	0.4	0.9
		Inch ounces	57	127
D7 D8	insert grounding screw	Newton meters	0.6	0.8
		Inch ounces	85	113
D7 D8	grounding screw	Newton meters	0.4	0.4
		Inch ounces	57	57
A10 A16 A32	wire termination screw	Newton meters	0.4	0.9
		Inch ounces	57	127
	insert fastening screw	Newton meters	0.7	1.1
		Inch ounces	99	156
	insert grounding screw	Newton meters	0.7	1.3
		Inch ounces	99	184
D15 D25 D50	insert fastening screw	Newton meters	0.7	1.1
		Inch ounces	99	156
	insert grounding screw	Newton meters	0.7	1.3
		Inch ounces	99	184
B T V	wire termination screw	Newton meters	0.4	0.6
		Inch ounces	57	85
	insert fastening screw	Newton meters	0.7	1.1
		Inch ounces	99	156
	insert grounding screw	Newton meters	1.2	1.9
		Inch ounces	170	269
C	wire termination screw	Newton meters	0.7	1.3
		Inch ounces	99	184
	insert fastening screw	Newton meters	0.7	1.1
		Inch ounces	99	156
	insert grounding screw	Newton meters	2.3	2.3
		Inch ounces	326	326
K	wire termination screw	Newton meters	*0.5 / 1.4	-
		Inch ounces	*71 / 198	-
	insert fastening screw	Newton meters	0.7	-
		Inch ounces	99	-
	insert grounding screw	Newton meters	2.3	-
		Inch ounces	326	-

* 16A / 80A contacts

(NOTE: Inch/ounces /16.0 = Pound /Inches)

Insert Mounting Screws accept a Pozi-drive screwdriver head. Common cross-point or bladed screwdrivers will also work. Specs refer to Pozi-drive or bladed common torque only.

Mounting Dimensions for Wiring Adapters

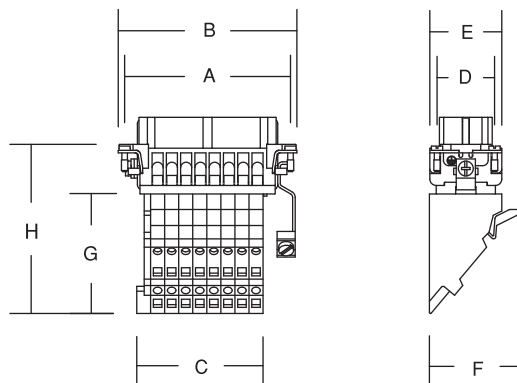

INSERT SERIES	CAT. NO.	DIMENSIONS ARE IN INCHES / (MILLIMETRES)							
		A	B	C	D	E	F	G	H
B6	FS106WAL	1.73 / (44)	2.01 / (51)	1.03 / (26.3)	1.06 / (27)	1.34 / (34)	1.77 / (45)	2.28 / (58)	3.54 / (90)
	FS106WAR								
B10	MS206WAL	2.13 / (54)	2.52 / (64)	1.55 / (39.5)	1.06 / (27)	1.34 / (34)	1.77 / (45)	2.28 / (58)	3.54 / (90)
	FS110WAL								
	FS110WAR								
	MS210WAR								
B16	MS210WAL	3.05 / (77.5)	3.32 / (84.5)	2.33 / (59.3)	1.06 / (27)	1.34 / (34)	1.77 / (45)	2.28 / (58)	3.54 / (90)
	FS116WAL								
	FS116WAR								
	MS216WAR								
B24	MS216WAL	4.09 / (104)	4.37 / (111)	3.36 / (85.7)	1.06 / (27)	1.34 / (34)	1.77 / (45)	2.28 / (58)	3.54 / (90)
	FS124WAL								
	FS124WAR								
	MS224WAL								
D40	MS224WAR	3.05 / (77.5)	3.27 / (83)	2.21 / (56)	1.06 / (27)	1.34 / (34)	3.19 / (81)	4.53 / (115)	5.12 / (130)
	FS340WAL								
D64	FS440WAL	4.09 / (104)	4.33 / (110)	3.39 / (86.3)	1.06 / (27)	1.34 / (34)	3.19 / (81)	4.53 / (115)	5.12 / (130)
	FS364WAL								
	MS464WAL								

(-WAL) — Ground Left; (-WAR) — Ground Right

Panel Cut Out Dimensions for Panel Bases

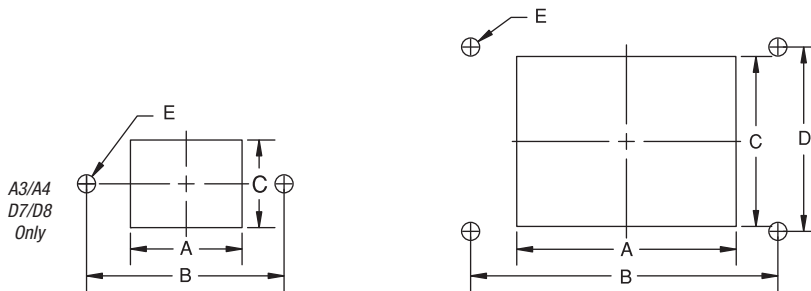

HOUSING SERIES				DIMENSIONS ARE IN INCHES / (MILLIMETRES)				
A, B, T, K	C, V	D	DD	A	B	C	D	E
A3, A4		D7, D8		.83 / (21)	1.18 / (30)	.83 / (21)	-	.125 / (3.2)
A10		D15		1.71 / (43.5)	2.76 / (70)	.95 / (24)	.68 / (17.5)	.134 / (3.4)
A16		D25		2.36 / (60)	3.39 / (86)	.95 / (24)	.68 / (17.5)	.134 / (3.4)
A32		D50		2.36 / (60)	3.62 / (92)	1.89 / (48)	1.65 / (28)	.177 / (4.5)
B6, T6			DD24	1.42 / (36)	2.76 / (70)	1.38 / (35)	1.26 / (32)	.177 / (4.5)
B10, T10	V3		DD42	1.93 / (49)	3.27 / (83)	1.38 / (35)	1.26 / (32)	.177 / (4.5)
B16, T16	C6, V6	D40	DD72	2.84 / (72)	4.06 / (103)	1.38 / (35)	1.26 / (32)	.177 / (4.5)
B24, T24, K12	V10, V16	D64	DD108	3.86 / (98)	5.12 / (130)	1.38 / (35)	1.26 / (32)	.177 / (4.5)
B32	C12	D80	DD144	2.84 / (72)	4.33 / (110)	2.80 / (71)	2.56 / (65)	.216 / (5.5)
B48, K24	V20, V26, V32	D128	DD216	3.86 / (98)	5.83 / (148)	2.80 / (71)	2.76 / (70)	.248 / (6.3)

* Dimensions reflect dual inserts mounting.

Pos-E-Kon® Pin and Sleeve Connectors

Mounting Dimensions for Double Post Hoods

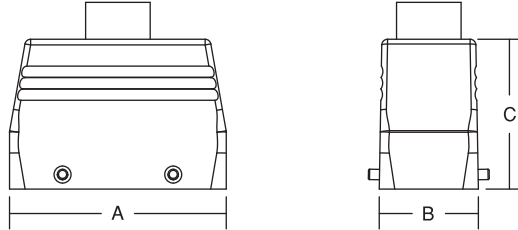

HOUSING SERIES				CAT. NO.	DIMENSIONS ARE IN INCHES / (MILLIMETRES)		
A, B, T, K	C, V	D	DD		C	D	E
A32	—	D50	—	SH_32A	3.23 / (82)	2.21 / (56)	2.99 / (76)
—	—	—	—	TH_32A	3.23 / (82)	2.21 / (56)	2.99 / (76)
—	—	—	—	SH_10	2.87 / (73)	1.69 / (43)	2.05 / (52)
B10, T10	V3	—	DD42	M3SH_10H ___	2.87 / (73)	1.69 / (43)	2.05 / (52)
—	—	—	—	TH_10	2.87 / (73)	1.69 / (43)	2.05 / (52)
—	—	—	—	TH_10H ___	2.87 / (73)	1.69 / (43)	2.05 / (52)
—	—	—	—	SH_16	3.70 / (94)	1.69 / (43)	2.56 / (65)
—	—	—	—	SH_16H	3.70 / (94)	1.69 / (43)	2.99 / (76)
B16, T16	C6, V6	D40	DD72	M5SH_16L	3.70 / (94)	1.69 / (43)	2.36 / (60)
—	—	—	—	TH_16	3.70 / (94)	1.69 / (43)	2.56 / (65)
—	—	—	—	TH_16H	3.70 / (94)	1.69 / (43)	2.99 / (76)
—	—	—	—	TH_16L	3.70 / (94)	1.69 / (43)	2.36 / (60)
—	—	—	—	SH_24	4.72 / (120)	1.69 / (43)	2.36 / (60)
—	—	—	—	SH_24H	4.72 / (120)	1.69 / (43)	2.99 / (76)
B24, T24, K12	V10, V16	D64	DD108	M7TH_24	4.72 / (120)	1.69 / (43)	2.21 / (56)
—	—	—	—	TH_24H	4.72 / (120)	1.69 / (43)	2.99 / (76)
—	—	—	—	TH424RC	4.72 / (120)	1.69 / (43)	2.99 / (76)
B32	C12	D80	DD144	SH_32	3.70 / (94)	3.11 / (79)	3.15 / (80)
—	—	—	—	TH_32	3.70 / (94)	3.11 / (79)	3.15 / (80)

Suffix: A - Aluminum, AP - Plastic, H - High Profile, L - Low Profile, RC - Ribbon Cable (top)

Mounting Dimensions for Single Post Hoods

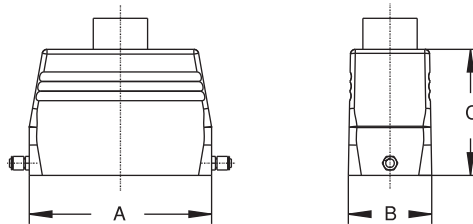

HOUSING SERIES				CAT. NO.	DIMENSIONS ARE IN INCHES / (MILLIMETRES)		
A, B, T, K	C,V	D	DD		C	D	E
A3, A4	—	D7, D8	—	SH603A(P)V	1.04 / (26.5)	1.04 / (26.5)	1.89 / (48)
—	—	—	—	TH803A(P)V	1.04 / (26.5)	1.04 / (36.5)	1.89 / (48)
—	—	—	—	SH_10A	2.48 / (63)	1.42 / (36)	2.60 / (66)
A10	—	D15	—	SH_10AL	2.48 / (63)	1.16 / (29.5)	2.09 / (53)
—	—	—	—	TH_10A	2.48 / (63)	1.42 / (36)	2.60 / (66)
—	—	—	—	TH_10AL	2.48 / (63)	1.16 / (29.5)	2.09 / (53)
—	—	—	—	SH_16A	3.13 / (79.5)	1.42 / (36)	2.84 / (72)
A16	—	D25	—	SH_16AL	3.13 / (79.5)	1.16 / (29.5)	2.28 / (58)
—	—	—	—	TH_16A	3.13 / (79.5)	1.42 / (36)	2.84 / (72)
—	—	—	—	TH_16AL	3.13 / (79.5)	1.16 / (29.5)	2.28 / (58)
—	—	—	—	SH_606	2.36 / (60)	1.69 / (43)	1.69 / (43)
B6, T6	—	—	DD24	M2SH_606HXXX	2.36 / (60)	1.69 / (43)	2.84 / (72)
—	—	—	—	TH_806	2.36 / (60)	1.69 / (43)	1.69 / (43)
—	—	—	—	TH_806HXXX	2.36 / (60)	1.69 / (43)	2.84 / (72)
—	—	—	—	SH_610	2.87 / (73)	1.69 / (43)	2.05 / (52)
B10, T10	V3	—	DD42	M3SH_610HXXX	2.87 / (73)	1.69 / (43)	2.84 / (72)
—	—	—	—	TH_810	2.87 / (73)	1.69 / (43)	2.05 / (52)
—	—	—	—	TH_810HXXX	2.87 / (73)	1.69 / (43)	2.84 / (72)
—	—	—	—	SH_616	3.70 / (94)	1.69 / (43)	2.56 / (65)
—	—	—	—	SH_616H	3.70 / (94)	1.69 / (43)	2.99 / (76)
—	—	—	—	SH_616L	3.70 / (94)	1.69 / (43)	2.36 / (60)
B16, T16	C6, V6	D40	DD72	M5TH_816	3.70 / (94)	1.69 / (43)	2.56 / (65)
—	—	—	—	TH_816H	3.70 / (94)	1.69 / (43)	2.99 / (76)
—	—	—	—	TH_816L	3.70 / (94)	1.69 / (43)	2.36 / (60)
—	—	—	—	TH816RC	3.70 / (94)	1.69 / (43)	2.99 / (76)
—	—	—	—	SH_624	4.72 / (120)	1.69 / (43)	2.99 / (76)
B24, T24	V10, V16	D64	DD108	M7SH_624L	4.72 / (120)	1.69 / (43)	2.36 / (60)
—	—	—	—	TH_824	4.72 / (120)	1.69 / (43)	2.99 / (76)
K12	—	—	—	TH824L	4.72 / (120)	1.69 / (43)	2.36 / (60)
—	—	—	—	TH624RC	4.72 / (120)	1.69 / (43)	2.99 / (76)
B48, K24	V20, V26,	D128	DD216	SH_48	5.16 / (131.5)	3.50 / (89)	3.78 / (96)
—	V32	—	—	TH_48	5.16 / (131.5)	3.50 / (89)	3.78 / (96)

Suffix: AP - Plastic, H - High Profile, L - Low Profile, RC - Ribbon Cable (top entry only)

Mounting Dimensions for Double Lever Coupler Hoods

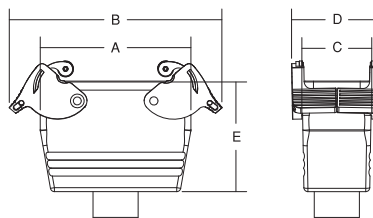

HOUSING SERIES				CAT. NO.	DIMENSIONS ARE IN INCHES / (MILLIMETRES)				
A, B, T, K	C, V	D	DD		A	B	C	D	E
B10, T10	V3		DD42	CH610E	2.87 / (73)	4.33 / (110)	1.69 / (43)	2.28 / (58)	2.02 / (51.5)
				CH610EHXXX	2.87 / (73)	4.33 / (110)	1.69 / (43)	2.28 / (58)	2.87 / (73)
				CH_16E	3.70 / (94)	5.16 / (131)	1.69 / (43)	2.28 / (58)	2.72 / (69)
B16, T16	C6, V6	D40	DD72	CH_16EH	3.70 / (94)	5.16 / (131)	1.69 / (43)	2.28 / (58)	3.15 / (80)
				CH616ERC	3.70 / (94)	5.16 / (131)	1.69 / (43)	2.28 / (58)	3.15 / (80)
				CH_24E	4.72 / (120)	6.18 / (157)	1.69 / (43)	2.28 / (58)	3.15 / (80)
B24, T24 K12	C6, V6	D40	DD72	CH624ERC	4.72 / (120)	6.18 / (157)	1.69 / (43)	2.28 / (58)	3.15 / (80)
				B32	C12	D80	DD144	CH_32E	3.70 / (94)

H - High Profile, RC - Ribbon Cable (top entry)

Mounting Dimensions for Single Lever Coupler Hoods

A3/A4
D7/D8
Only

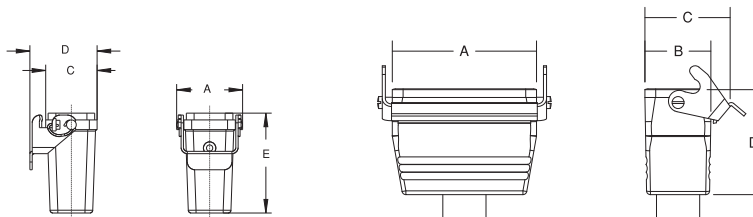

HOUSING SERIES				CAT. NO.	DIMENSIONS ARE IN INCHES / (MILLIMETRES)				
A, B, T, K	C, V	D	DD		A	B	C	D	E
A3, A4		D7, D8		CH803A(P)*	1.34 / (34)	-	1.04 / (26.5)	1.43 / (36.5)	2.02 / (51.5)
A10		D15		CH810A	2.48 / (63)	-	1.16 / (29.5)	1.92 / (49)	1.89 / (48)
A16	C6, V6	D25		CH816A	3.13 / (79.5)	-	1.16 / (29.5)	1.92 / (49)	2.09 / (53)
B6, T6			DD24	CH806	2.36 / (60)	-	1.69 / (43)	2.56 / (65)	2.02 / (51.5)
				CH806HXXX	2.36 / (60)	-	1.69 / (43)	2.56 / (65)	2.87 / (73)
B10, T10	V3		DD24	CH810	2.87 / (73)	-	1.69 / (43)	2.64 / (67)	2.02 / (51.5)
				CH810HXXX	2.87 / (73)	-	1.69 / (43)	2.64 / (67)	2.87 / (73)
				CH_16	3.70 / (94)	-	1.69 / (43)	2.64 / (67)	2.72 / (69)
B16, T16	C6, V6	D40	DD72	CH_16H	3.70 / (94)	-	1.69 / (43)	2.64 / (67)	3.15 / (80)
				CH616RC	3.70 / (94)	-	1.69 / (43)	2.64 / (67)	3.15 / (80)
				CH_24	4.72 / (120)	-	1.69 / (43)	2.64 / (67)	3.15 / (80)
B24, T24	V10, V16	D64	DD108	CH824RC	4.72 / (120)	-	1.69 / (43)	2.64 / (67)	3.15 / (80)

*Suffix: A - Aluminum, AP - Plastic, H - High Profile, L - Low Profile, RC - Ribbon Cable (top entry only)

Mounting Dimensions for Double Post Box Bases (Reverse Locking)

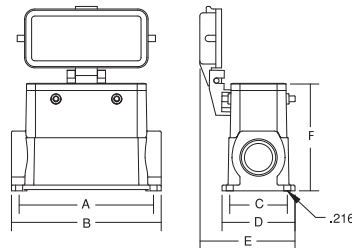

HOUSING SERIES				CAT. NO.	DIMENSIONS ARE IN INCHES / (MILLIMETRES)					
A, B, T, K	C, V	D	DD		A	B	C	D	E	F
A32		D50		BB_32A	3.70 / (94)	4.17 / (106)	1.81 / (46)	2.32 / (59)	3.11 / (79)	3.20 / (81.5)
				BB_32A100	3.70 / (94)	4.17 / (106)	1.81 / (46)	2.32 / (59)	3.11 / (79)	3.20 / (81.5)
B10, T10	V3		DD42	BB_10	3.23 / (82)	3.66 / (93)	1.56 / (40)	2.05 / (52)	2.87 / (73)	2.05 / (52)
				BB_10H	3.23 / (82)	3.66 / (93)	1.77 / (45)	2.24 / (57)	2.97 / (75.5)	2.91 / (74)
B16, T16	C6, V6	D40	DD72	BB_16	4.13 / (105)	4.61 / (117)	1.77 / (45)	2.24 / (57)	2.97 / (75.5)	2.68 / (68)
				BB_24	5.20 / (132)	5.67 / (144)	1.77 / (45)	2.24 / (57)	2.97 / (75.5)	2.68 / (68)
B24, T24 K12	C6, V6	D40	DD72	BB_24	5.20 / (132)	5.67 / (144)	1.77 / (45)	2.24 / (57)	2.97 / (75.5)	2.68 / (68)
				BB_24H	5.20 / (132)	5.67 / (144)	1.77 / (45)	2.24 / (57)	2.97 / (75.5)	3.31 / (84)

H - High Profile

Mounting Dimensions for Double Post Panel Bases (Reverse Locking)

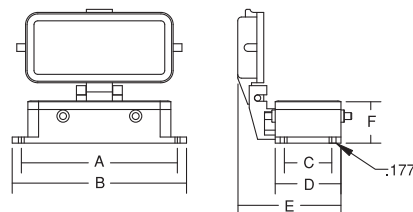

HOUSING SERIES				CAT. NO.	DIMENSIONS ARE IN INCHES / (MILLIMETRES)					
A, B, T, K	C, V	D	DD		A	B	C	D	E	F
A32		D50		PB232A	3.62 / (92)	4.02 / (102)	1.65 / (42)	2.24 / (57)	3.15 / (80)	1.10 / (28)
B10, T10	V3		DD42	PB210	3.27 / (83)	3.66 / (93)	1.26 / (32)	1.69 / (43)	2.68 / (68.5)	1.06 / (27)
B16, T16	C6, V6	D40	DD72	PB216	4.06 / (103)	4.49 / (114)	1.26 / (32)	1.69 / (43)	2.68 / (68.5)	1.06 / (27)
B24, T24 K12	C6, V6	D40	DD72	PB224	5.12 / (130)	5.51 / (140)	1.26 / (32)	1.69 / (43)	2.68 / (68.5)	1.06 / (27)

Mounting Dimensions for Double Lever Hoods (Reverse Locking)

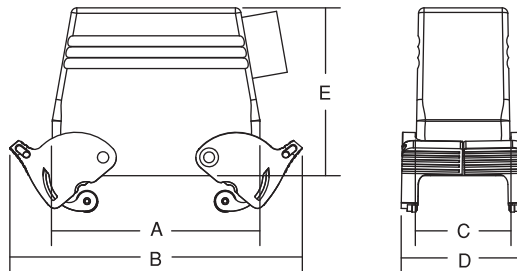

HOUSING SERIES				CAT. NO.	DIMENSIONS ARE IN INCHES / (MILLIMETERS)				
A, B, T, K	C, V	D	DD		A	B	C	D	E
A32		D50		LH_32A	3.23 / (82)	5.04 / (128)	2.21 / (56)	2.76 / (70)	2.99 / (76)
B10, T10	V3		DD42	LH_10E LH_10EH	2.87 / (73)	4.33 / (110)	1.69 / (43)	2.28 / (58)	1.89 / (48)
B16, T16	C6, V6	D40	DD72	LH_16E LH_16EH	3.70 / (94)	5.16 / (131)	1.69 / (43)	2.28 / (58)	2.56 / (65)
B24, T24, K12	V10, V16	D64	DD108	LH_24E	4.72 / (120)	6.18 / (157)	1.69 / (43)	2.28 / (58)	2.99 / (76)

H - High Profile

Dust Covers for Housings



HOUSING SERIES				FOR SINGLE LEVER HOUSINGS	FOR DOUBLE LEVER HOUSINGS	FOR SINGLE POST HOUSINGS	FOR DOUBLE POST HOUSINGS
A, B, T, K	C, V	D	DD				
A3, A4		D7, D8		DCL103A-1			
A10		D15		DCL110A-1		DCS110A-1	
A16		D25		DCL116A-1		DCS116A-1	
A32		D50			DCL232A-1/DCL432A-1*		DCS232A-1
B6, T6**			DD24	DCL106B-1			
B10, T10**	V3		DD42	DCL110B-1	DCL210B-1/DCL410B-1*		
B16, T16**	C6, V6	D40	DD72	DCL116B-1	DCL216B-1/DCL416B-1*		
B24, T24**, K12	V10, V16	D64	DD108	DCL124B-1	DCL224B-1/DCL424B-1*		

* Comes with gasket for hoods w/levers and w/o gaskets

** Dust covers tested only to 125°C (if applied to 200°C series T)



Sub-Miniature Adapter Plate Selection Guide

HOUSING SERIES				SUB-MINIATURE CONNECTOR				
A, B, T, K	C, V	D	DD	DB9	DB15	DB25	DB37	DB50
A3, A4		D7, D8		NO ADAPTER FOR THIS SERIES				
A10		D15		AP681A10	AP677A10	AP678A10		
A16		D25					AP682A16	AP683A16
A32		D50						
B6, T6	DD24	M2		AP796B6 AP802B6*	AP797B6 AP803B6*			
B10, T10	V3		DD42			AP798B10 AP804B10*		
B16, T16	C6, V6	D40	DD72				AP799B16 AP805B16*	AP800B16 AP806B16*
B24, T24, K12	V10, V16	D64	DD108			N/A		
B32	C12	D80	DD144			N/A		
B48, K24	V20, V26, V32	D128	DD216			N/A		

* Dual Mounting

Sub-Miniature Adapter Plate Mounting Dimensions

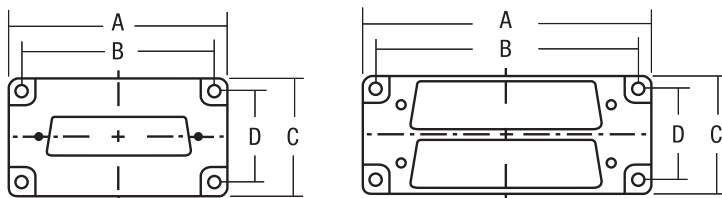

* Dual Mounting

CAT. NO.	DIMENSIONS ARE IN INCHES / (MILLIMETERS)			
	A	B	C	D
AP677A10	2.22 / (56.5)	.91 / (23)	1.95 / (49.5)	.63 / (16)
AP678A10	2.22 / (56.5)	.91 / (23)	1.95 / (49.5)	.63 / (16)
AP681A10	2.22 / (56.5)	.91 / (23)	1.95 / (49.5)	.63 / (16)
AP682A16	2.87 / (73)	.91 / (23)	2.60 / (66)	.63 / (16)
AP683A16	2.87 / (73)	.91 / (23)	2.60 / (66)	.63 / (16)
AP796B6	2.03 / (51.5)	1.73 / (44)	1.36 / (34.5)	1.06 / (27)
AP797B6	2.03 / (51.5)	1.73 / (44)	1.36 / (34.5)	1.06 / (27)
AP798B10	2.54 / (64.5)	2.24 / (57)	1.36 / (34.5)	1.06 / (27)
AP799B16	3.35 / (85)	3.05 / (77.5)	1.36 / (34.5)	1.06 / (27)
AP800B16	3.35 / (85)	3.05 / (77.5)	1.36 / (34.5)	1.06 / (27)
AP802B6*	2.03 / (51.5)	1.73 / (44)	1.36 / (34.5)	1.06 / (27)
AP803B6*	2.03 / (51.5)	1.73 / (44)	1.36 / (34.5)	1.06 / (27)
AP804B10*	2.54 / (64.5)	2.24 / (57)	1.36 / (34.5)	1.06 / (27)
AP805B16*	3.35 / (85)	3.05 / (77.5)	1.36 / (34.5)	1.06 / (27)
AP806B16*	3.35 / (85)	3.05 / (77.5)	1.36 / (34.5)	1.06 / (27)

* Dual Mounting

Pos-E-Kon® Pin and Sleeve Connectors

Size Adapter Plate: Selection Guide for Panel Installation

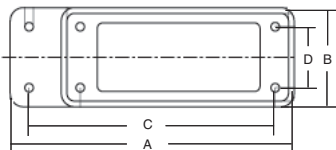

NOTE: Adapter plates are for use with panel bases in Series B24, D64, DD108, M7, V10, and V16

ADAPTER SIZE	CAT. NO.	DIMENSIONS ARE IN INCHES / (MILLIMETERS)			
		A	B	C	D
B24 TO B6	AP650B6	5.90 / (150)	2.05 / (52)	5.12 / (130)	1.26 / (32)
B24 TO B10	AP651B10	5.90 / (150)	2.05 / (52)	5.12 / (130)	1.26 / (32)
B24 TO B16	AP652B16	5.90 / (150)	2.05 / (52)	5.12 / (130)	1.26 / (32)

H - High Profile

Cover Plate Selection Guide

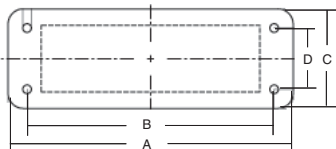

HOUSING SERIES				CAT. NO.	DIMENSIONS ARE IN INCHES / (MILLIMETERS)			
A, B, T, K	C, V	D	DD		A	B	C	D
A3, A4		D7, D8						
A10		D15		CP684A10	3.43 / (87)	2.76 / (70)	1.57 / (40)	.69 / (17.5)
A16		D25		CP685A16	3.94 / (100)	3.39 / (86)	1.77 / (45)	.69 / (17.5)
B6, T6			DD24	CP638B6	3.39 / (86)	2.76 / (70)	2.05 / (52)	1.26 / (32)
B10, T10	V3		DD42	CP639B10	4.02 / (102)	3.27 / (83)	2.05 / (52)	1.26 / (32)
B16, T16	C6, V6	D40	DD72	CP640B16	4.84 / (123)	4.06 / (103)	2.05 / (52)	1.26 / (32)
B24, T24, K12	V10, V16	D64	DD108	CP641B24	5.91 / (150)	5.12 / (130)	2.05 / (52)	1.26 / (32)

NOTE: Cover plates are for use on panel bases only

Gaskets

HOUSING SERIES				CAT. NOS.	
A, B, T, K	C, V	D	DD	PANEL BASE, FLAT	*MOLDED EDGE CONTOUR
A3, A4		D7, D8		A04XFGP	A04XMEC
A10		D15		A10XFGP	A10XMEC
A16		D25		A16XFGP	A16XMEC
A32		D50		A32XFGP	A32XMEC
B6, T6**			DD24	B6XFGP	B6XMEC
B10, T10**	V3		DD42	B10XFGP	B10XMEC
B16, T16**	V6, C6	D40	DD72	B16XFGP	B16XMEC
B24, T24**, K12	V10, V16	D64	DD108	B24XFGP	B24XMEC
B32	C12	D80	DD144	B32XFGP	B32XMEC
B48, K24	V20, V26, V32	D128	DD216	B48XFGP	B48XMEC

* Install with silicone sealant/adhesive for industrial use.

** For T series 200°C applications, specify catalog number at right except "T" prefix instead of "B" for gaskets.

EX: Use "T16XFGP" for panel base gaskets.

Coding Pins, Guide Pins and Sleeves can be used in all series housings, with all inserts.

Coding Pin



PC600

Coding Pins:

Used for rejection in multiple "same size or series" insert/hood installations. Patterns show examples of rejection coding pins installed.

Coding possibilities for single insert series



Coding possibilities for double insert series

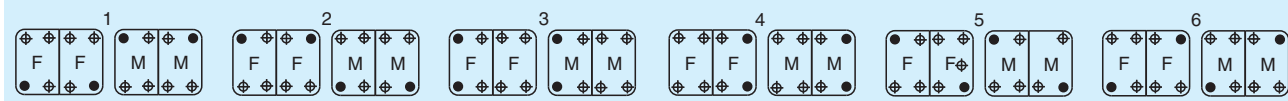

Guide Pin



MG601

Guide Sleeve



FG602

Guide Pins and Sleeves:

Perform same function as coding pins and/or aid hi-density insert mating as well.

Coding possibilities for single insert series

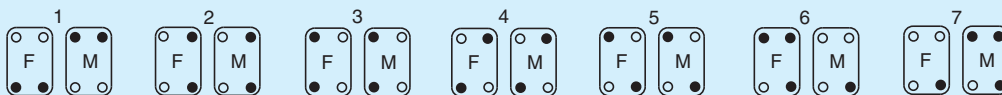

Coding possibilities for double insert series

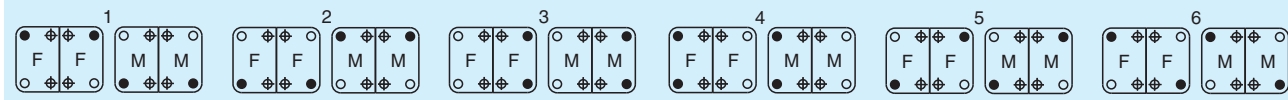

- – Male Guide Pins or Coding Pins
- – Female Guide Sleeves
- ⊕ – Mounting Screw



Supplied standard with all hoods and bases.
Special sizes/hood combinations available.



Style may vary depending on size.



Standard European style – can be specified/supplied with hoods and bases.

Metric PG-to-NPT Thread Adapters

CAT. NO.	NPT THREAD (MATING)	THREAD (AT HOUSING)
PG11-38	3/8"	PG11
PG16-50	1/2"	PG16
PG21-75	3/4"	PG21
PG29-100	1"	PG29
PG36-125	1 1/4"	PG29
PG36-125	1 1/4"	PG36
PG36-150	1 1/2"	PG36
PG42-200	2"	PG42

Metric ISO-to-NPT Thread Adapters

CAT. NO.	NPT THREAD (MATING)	THREAD (AT HOUSING)
M20-38	3/8"	M20
M20-50	1/2"	M20
M20-75	3/4"	M20
M32-100	1"	M32
M32-125	1 1/4"	M32
M40-125	1 1/4"	M40
M40-150	1 1/2"	M40

Metric Two-Screw Clamp Connectors

CAT. NO.	CABLE O.D. (IN.)		THREAD (AT HOUSING)
	MIN.	MAX.	
CC11-38	.400"	.470"	PG11
CC11-38P*	.250"	.325"	PG11
CC135-50	.400"	.535"	PG13.5
CC16-50	.455"	.625"	PG16
CC21-75	.513"	.815"	PG21
CC21-100	.800"	.175"	PG291
CC36-125	1.050"	.450"	PG361
CC42-150	1.500"	.800"	PG421

* Plastic

Metric Cord Grip Connectors

CAT. NO.	CABLE O.D. (IN.)		THREAD (AT HOUSING)
	MIN.	MAX.	
CG11-38	.200"	.470"	PG11
CG11-38P*	.325"	.340"	PG11
CG135-50	.285"	.545"	PG13.5
CG16-50	.285"	.625"	PG16
CG21-75	.395"	.790"	PG21
CG29-100	.780"	.060"	PG291
CG36-125	.780"	.060"	PG291
CG42-150	1.500"	.800"	PG421

* Plastic

Conduit Entry Blind Plug

CAT. NO.	THREAD (AT HOUSING)
CXP722	PG13.5
CXP723	PG16
CXP724	PG21
CXP725	PG29
CXP726	PG36
CXP727	PG42

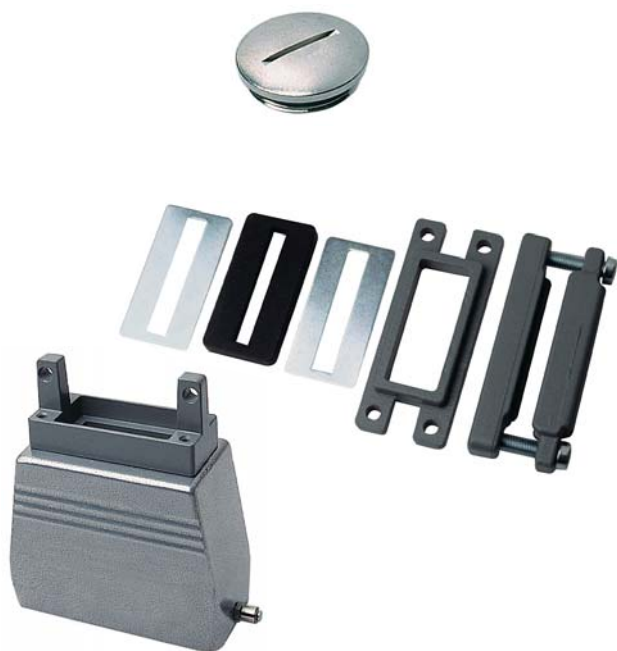

Ribbon Cable Entry Strain Relief Kit for Hoods

CAT. NO.	DESCRIPTION	ENTRY
RHK 601	One cable entry	40 x 5mm
RHK 602	Two cable entry	40 x 10mm
RHK 603	Three cable entry	40 x 15mm

Ribbon Cable Entry Strain Relief Kit for Bases

CAT. NO.	HUB SIZE
RBK 708	PG 16
RBK 709	PG 21
RBK 710	PG 29
RBK 711	PG 36
RBK 712	PG 42

Other sizes available as specials.



Non-Metallic Cord Grip Fittings

NPT THREADS CAT. NO.	CORD RANGE		THREAD SIZE
	IN.	MM	
CC-NPT38-G	.197"-.394"	5-10mm	3/8"
CC-NPT12-G	.394"-.551"	10-14mm	1/2"
CC-NPT34-G	.512"-.709"	13-18mm	3/4"
CC-NPT1-G	.709"-.984"	18-25mm	1"

PG THREADS CAT. NO.	CORD RANGE		THREAD SIZE
	IN.	MM	
CC-PG11-G	.197"-.394"	5-10mm	11
CC-PG135-G	.336"-.473"	6-12mm	13.5
CC-PG16-G	.394"-.551"	10-14mm	16
CC-PG21-G	.512"-.709"	13-18mm	21
CC-PG29-G	.709"-.984"	18-25mm	29
CC-PG36-G	.867"-.1.26"	22-32mm	36



Connection with Fiber Optic (POF) Cable

Instructions

1. Before crimping the POF* cable, 1,0 mm to the glass fiber cable contact, the end of the fiber has to be polished. Stick end of POF* cable into polishing tool and grind on a plane surface (e.g. glass plate). Wipe off any residues after polishing. The best optical damping values are achieved with wet-polishing-procedure.



2. Strip 1,0 mm POF* cable on min. 14 mm for D sleeve contacts and min. 19 mm for D pin contacts.

for sleeve contacts min. 14 mm
for pin contacts min. 19 mm

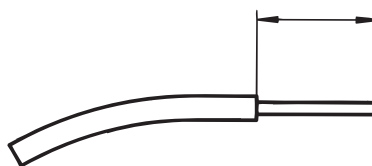

3. Insert stripped POF* cable in sleeve or pin contact until stop. The optical fiber should then stick about 1 mm out of the contact.

sleeve contact about 1,0 mm



pin contact about 1,0 mm



4. Optical Fiber crimping:

Adjust the positioning sleeve into the corresponding inlet of the crimping tool with the stop screw at 1,45 mm (if necessary check with gauge pin, diameter 1,45 mm, with closed crimping tool).

Insert the glass fiber cable contact together with the POF* cable through the crimp opening of the crimping tool into the positioning sleeve.

By pressure on the contact the fiber inside the contact will be locked into the right position for the fiber crimping. Continue pressure until the release mechanism is heard.

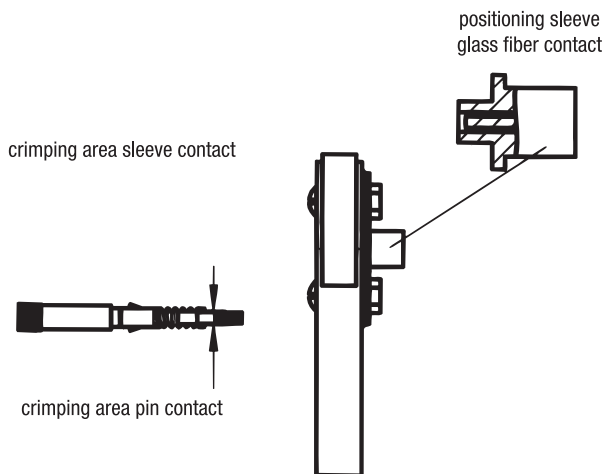

*POF = Polymer Optical Fiber

For use in M10 Series Inserts

Crimp Tool

4 Indent



CT610F

Polishing Tool



FPT702

Glass Fiber Cable Positioning sleeve



FPS701

Polishing Sheet

1000 Grain



FSS703

Stripper 1,0 mm



FST700

Male Pin



Female Sleeve



Count on Thomas & Betts for the Right Tools for the Right Job!

Since the 1930s, Thomas & Betts has been supplying tools, dies and connectors. Today, with more than 75 years experience in tools, dies and connectors, Thomas & Betts still sets the standard for innovation, quality and performance for application tooling. Rely on Thomas & Betts tools for labor-saving features, user comfort and convenience, long service life and extraordinary value.

Application Tooling Support — At Your Service

For more than 40 years, Thomas & Betts' highly trained, experienced and dedicated Tool Services staff has been supporting customers in every aspect of their tooling needs. With 100-plus years of combined experience, T&B application tool specialists are ready to assist you with:

- Tool recommendations based on your application and workload
- Demonstrations
- Rental and leasing programs
- On-site installation
- On-site training
- Technical support
- Calibration and certification (factory or on-site)
- Repair (both warranty and non-warranty)
- Loaners for temporary use during repairs
- Supplying components and technical documentation for customer-performed repairs

Tool Repair

Thomas & Betts Tool Services repairs all Thomas & Betts tools, from simple hand tools to hydraulic pumps and crimping heads. Tool Services performs all warranty repairs and can supply you with a temporary loaner tool when necessary. Tool Services can also perform non-warranty repairs, or, if you wish to repair your own tools, contact Tool Services to obtain any needed components, technical documentation and support.

Tool Rental Program

For short-term installation projects, sometimes it makes more sense to rent than buy power tools. Thomas & Betts Tool Services understands this and has created a Tool Rental Program, geared specifically for contractors and projects, to meet the need. Renting T&B tools is easy. A rental agreement is available on our web site, and you can pay the rental fee by credit card. Call Tool Services at **1-800-284-TOOL (8665)** for more details, including a list of Thomas & Betts tools available for rental.



Tool Leasing Program

For longer term use, many OEMs find that leasing high-end tools may be more financially attractive than purchasing. Call Tool Services at **1-800-284-TOOL (8665)** for more information and a list of Thomas & Betts tools available for lease.

Thomas & Betts Tool Warranty

You can choose Thomas & Betts tools with confidence, because we stand behind them with our warranty. The chart below shows the standard length of warranty for different types of tools. See below for additional warranty details.

1 Year

- Cable Tie Installation Tools
- Printers
- Cable Cutters & Strippers
- Dies

2 Years

- Mechanical Hand Tools with Shure-Stake® Mechanism
- Pneumatic Tools
- Hydraulic Pumps
- Battery-Operated Tools

5 Years

- Mechanical Hand Tools without Shure-Stake® Mechanism
- Hydraulic Tools (self-contained and remote heads)

Call Toll-Free **1-800-284-TOOL (8665)**

For more information about Thomas & Betts Tool Services:

E-Mail us at toolservice@tnb.com

Limited Warranty for Tools

Thomas & Betts sells tools with the understanding that the user will perform all necessary tests to determine the suitability of each tool for the user's intended application. Thomas & Betts warrants that its tools will be free from defects in materials and workmanship for the period of time specified above. Upon prompt notification of any warranted defect, Thomas & Betts will, at its option, repair or replace the defective product or refund the purchase price. Proof of purchase is required. Misuse or unauthorized modification of the product voids all warranties.

Limitations and Exclusions

The warranty above is the sole warranty concerning this product, and is in lieu of all other warranties express or implied, including but not limited to any implied warranty of merchantability or fitness for a particular purpose, which are specifically disclaimed. Liability for breach of the above warranty is limited to cost of repair or replacement of the product, and under no circumstances will Thomas & Betts be liable for any indirect, special, incidental or consequential damages.

Direct all warranty inquiries to: Thomas & Betts Tool Services **1-800-284-TOOL (8665)**.