

## Approximate dimensions A/AE9 – A/AE26, 3 pole

00.00 Inches  
00.00 [Millimeters]

### A/AE9 – A/AE16 – Contactor, 3 pole

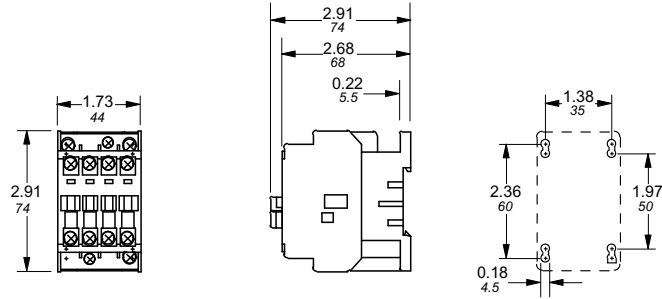

### A/AE9 – A/AE16 + VM5 or VE5 – Mechanically interlocked contactor, 3 pole

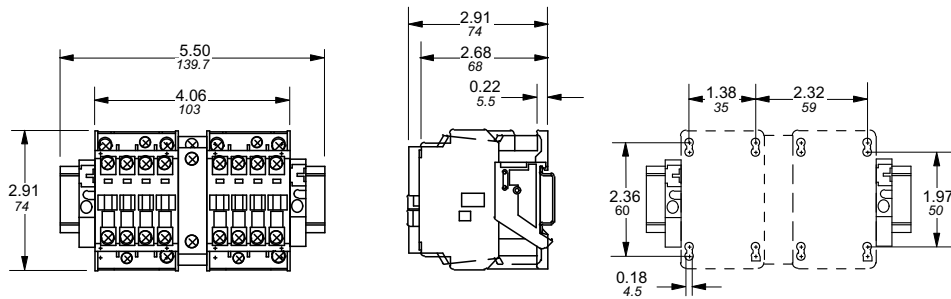

### A/AE26 – Contactor, 3 pole

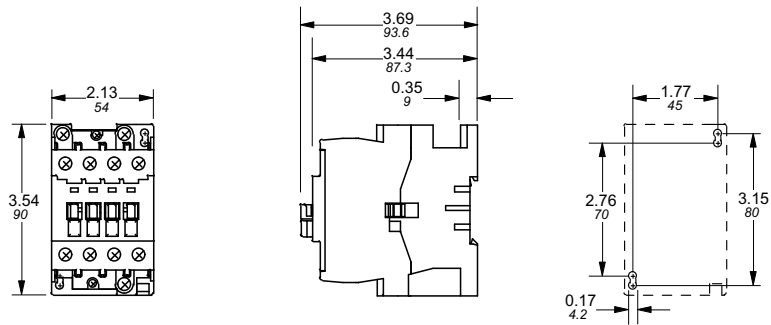

### A/AE26 + VM5 or VE5 – Mechanically interlocked contactor, 3 pole

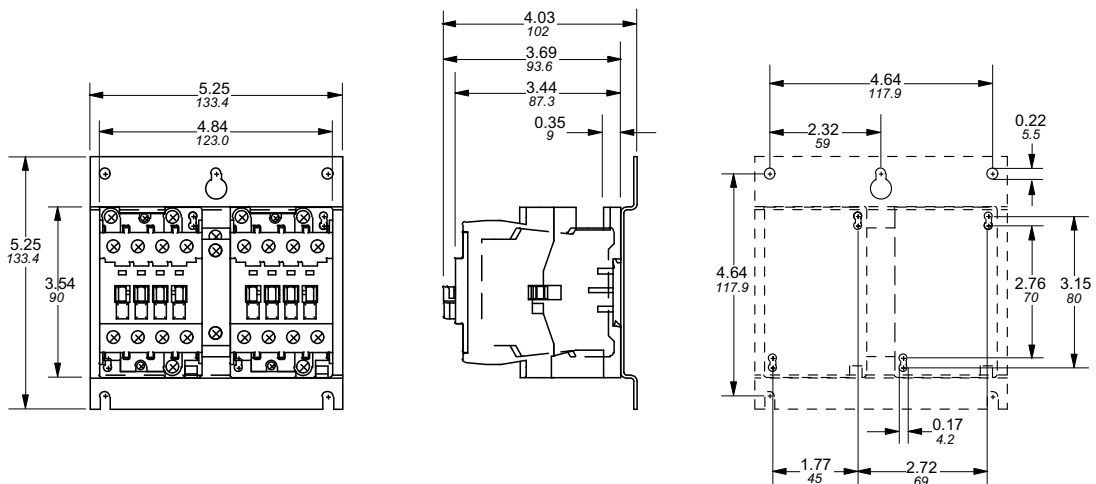

## Approximate dimensions A/AE30 – A/AE/AF75, 3 pole

00.00 Inches  
00.00 [Millimeters]

### A/AE30 & A/AE40 – Contactor, 3 pole

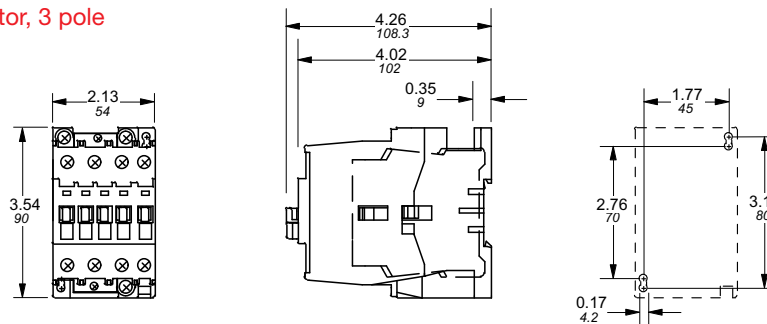

### A/AE30 & A/AE40 + VM5 or VE5 – Mechanically interlocked contactor, 3 pole

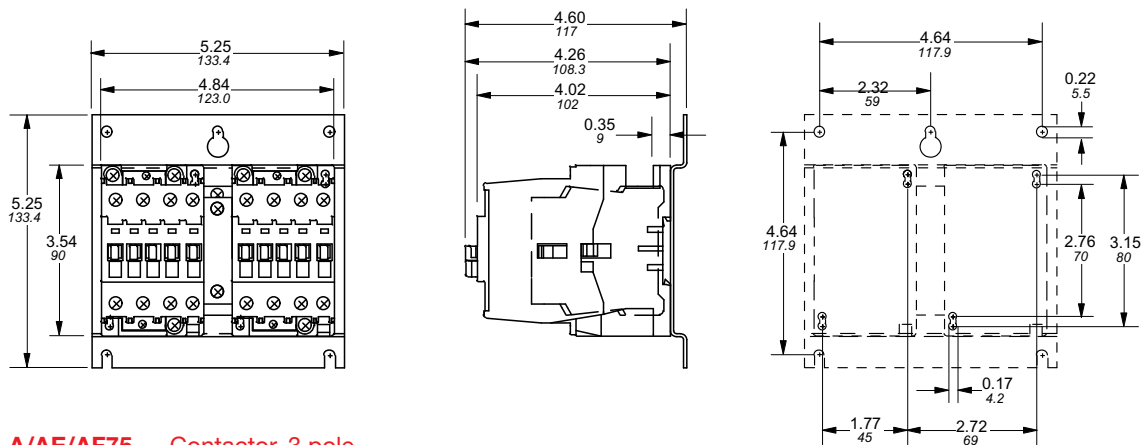

### A/AE/AF50 – A/AE/AF75 – Contactor, 3 pole

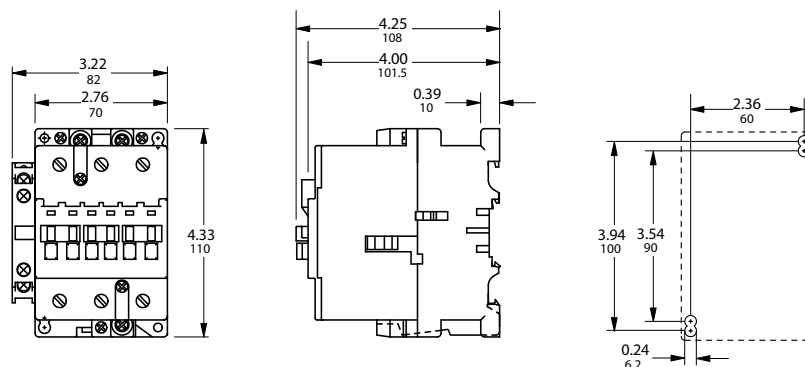

### A/AE/AF50 – A/AE/AF75 + VM5 or VE5 – Mechanically interlocked contactor, 3 pole

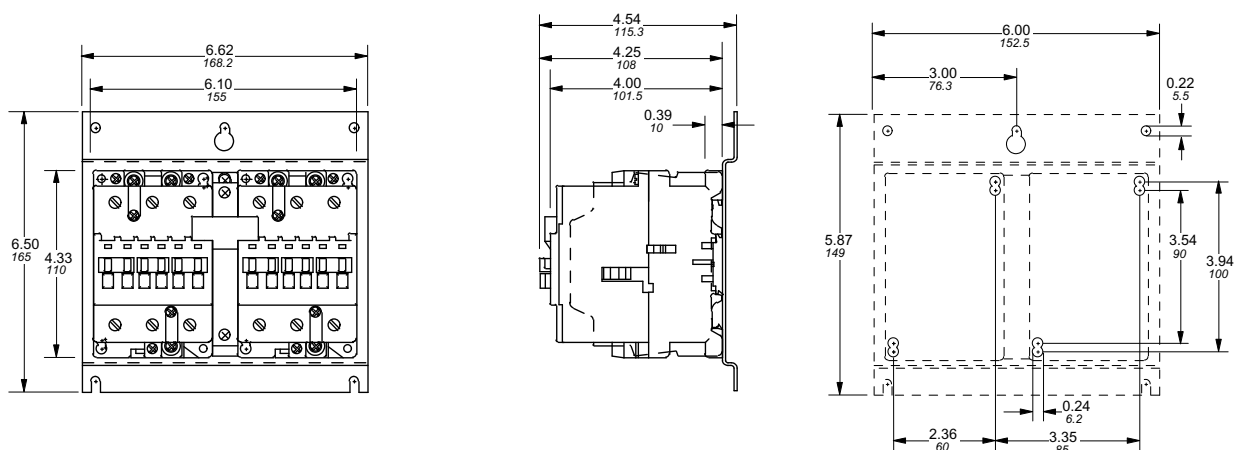

## Approximate dimensions A/AE/AF95 & A/AE/AF110, 3 pole

00.00 Inches  
00.00 [Millimeters]

### A/AE/AF95 & A/AE/AF110 — Contactor, 3 pole

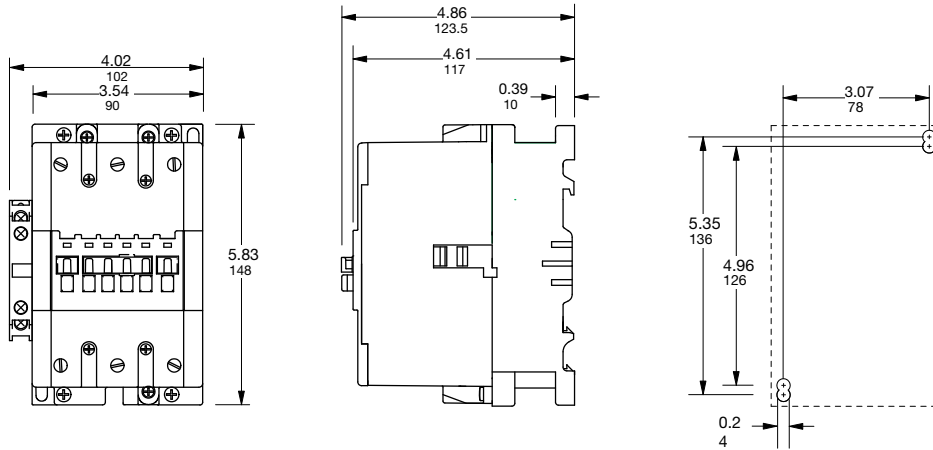

### A/AE/AF95 & A/AE/AF110 + VE5 — Mechanically interlocked contactor, 3 pole

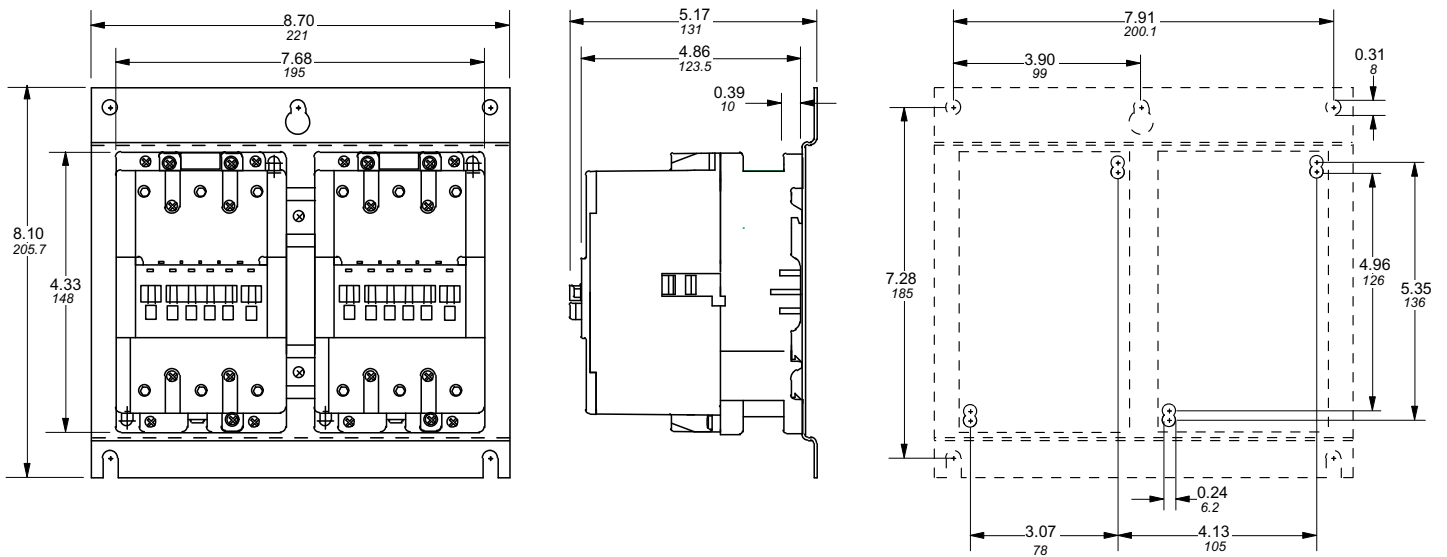

## Approximate dimensions A/AE9 – A/AE/AF75, 4 pole

00.00 Inches  
00.00 [Millimeters]

### A/AE9 – A/AE16 – Contactor, 4 pole

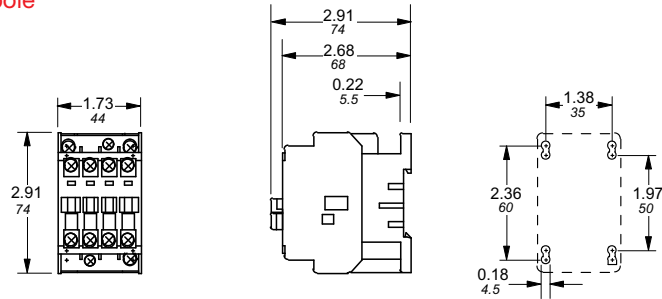

### A/AE26 – Contactor, 4 pole

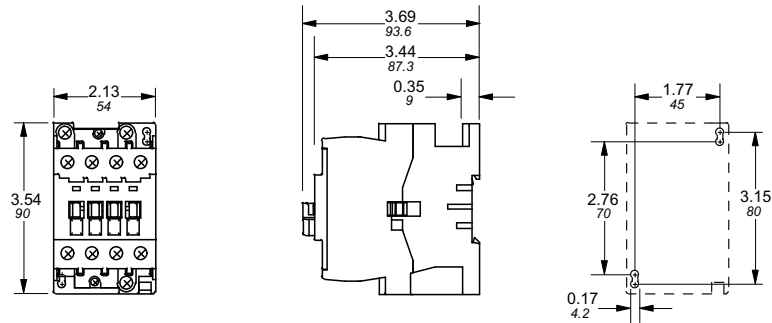

### A/AE/AF45 – A/AE/AF75 – Contactor, 4 pole

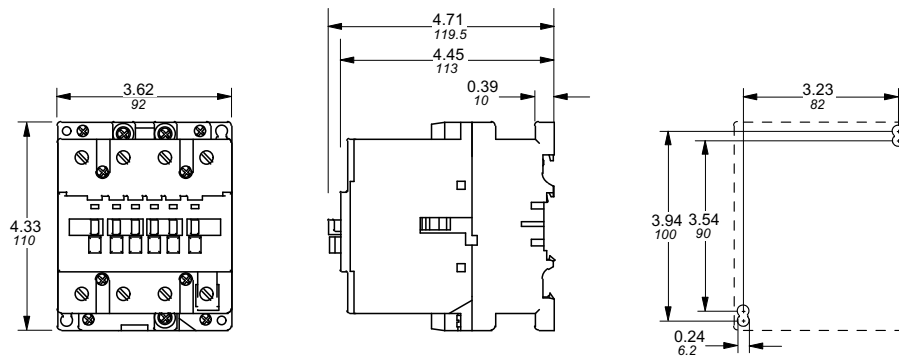

## Approximate dimensions AL9 – AL40, 3 & 4 pole

00.00 Inches  
00.00 [Millimeters]

### AL9, AL12, AL16 – Contactor, 3 & 4 pole

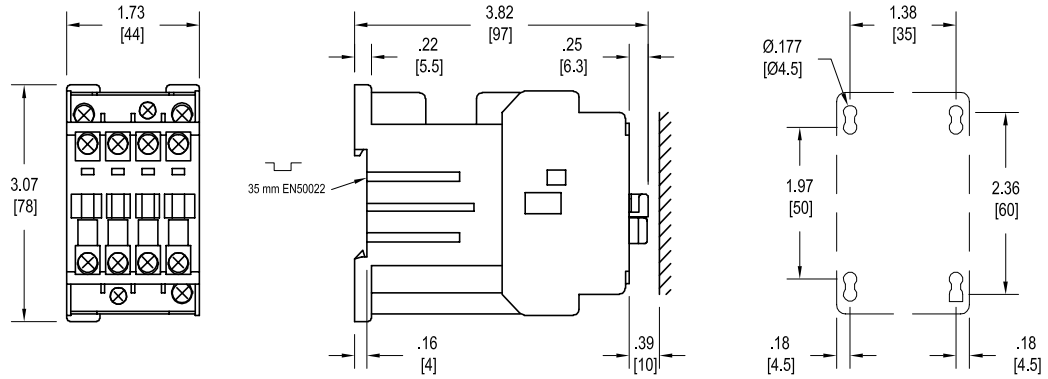

### AL26 – Contactor, 3 & 4 pole

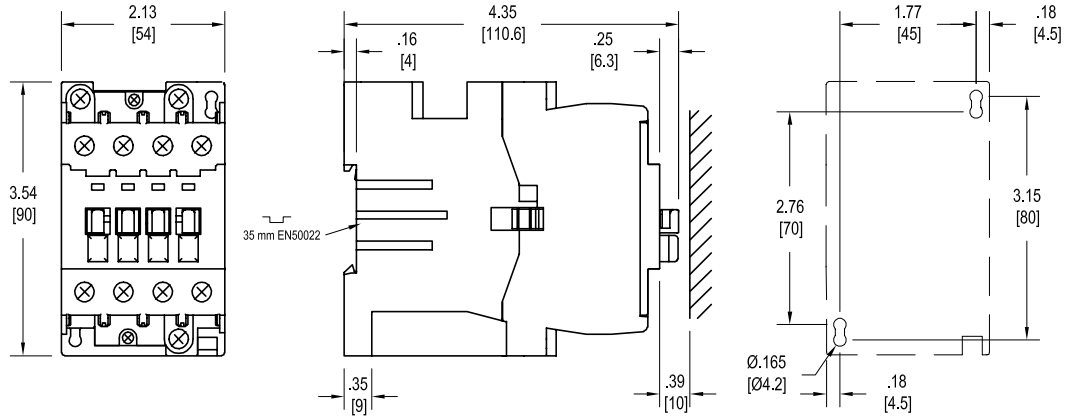

### AL30, AL40 – Contactor, 3 pole

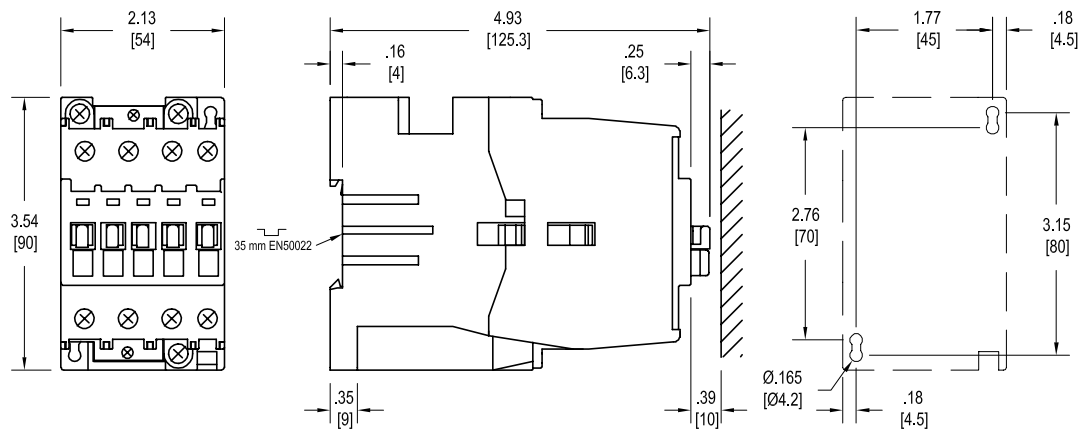

## Approximate dimensions

### Accessories for A/AE9 – A/AE/AF110

00.00 Inches  
00.00 [Millimeters]

A/AE9 – A/AE40  
A/AE/AF50 – A/AE/AF110

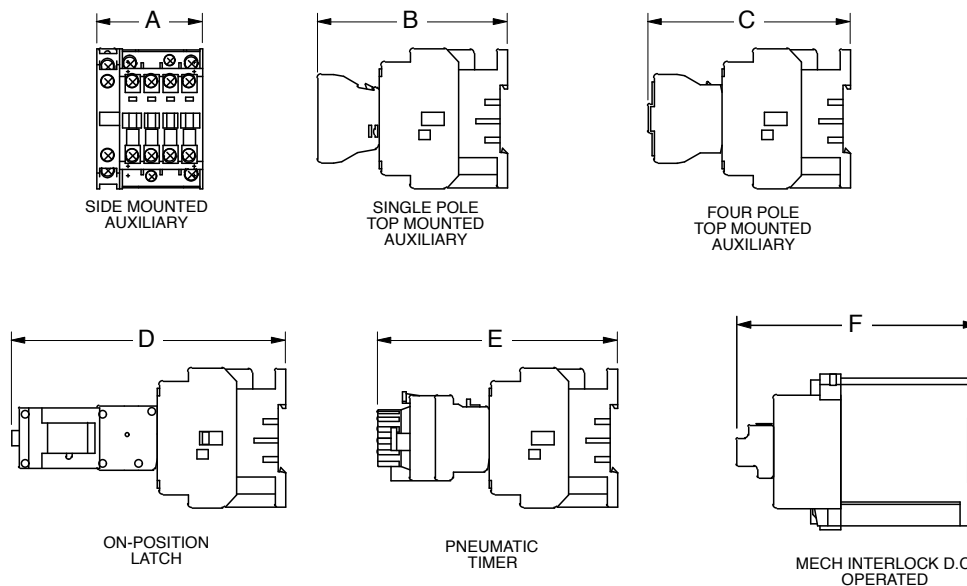

TYPE		A	B	C	D	E	F
A/AE9-16	IN	2.20	3.96	4.21	5.71	5.00	–
	MM	56	100.5	107	145	127	–
A/AE26	IN	2.20	4.72	4.97	6.47	5.76	–
	MM	56	119.8	126.3	164.3	146.3	–
A/AE30-40	IN	2.20	5.30	5.55	7.05	6.34	–
	MM	56	134.5	141	179	161	–
A/AE/AF50-75	IN	3.23	5.27	5.52	7.03	6.32	–
	MM	82	133.9	140.3	178.5	160.4	–
A/AE/AF45	IN	4.09	5.73	5.98	7.48	6.77	–
	MM	104	145.5	152	190	172	–
A/AE/AF95-110	IN	4.02	5.91	6.16	–	–	–
	MM	102	150	156.5	–	–	–

## Approximate dimensions A/AF145 – A/AF185

00.00 Inches  
00.00 [Millimeters]

### A/AF145 & A/AF185

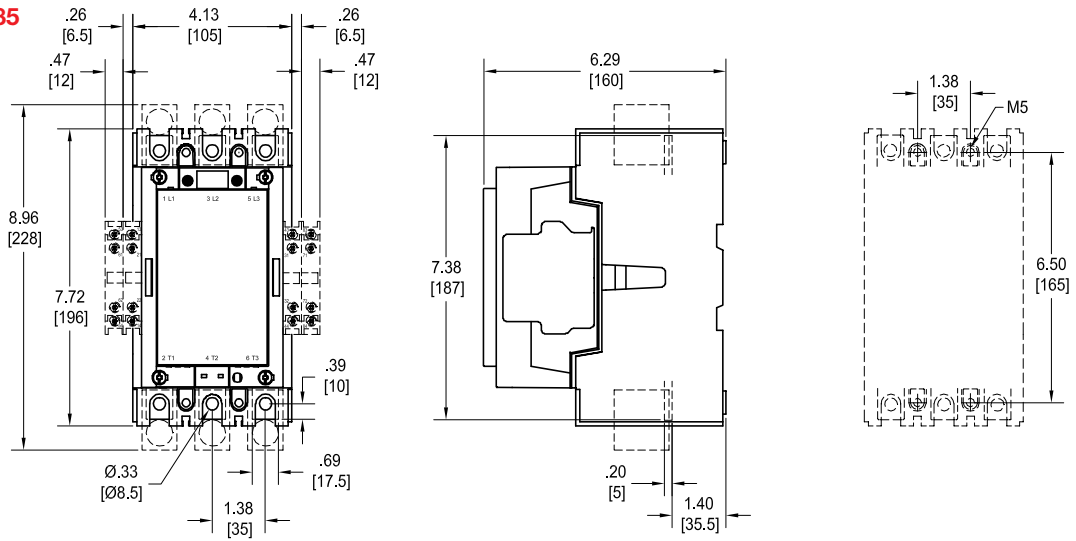

### A/AF145, A/AF185 with mechanical interlock

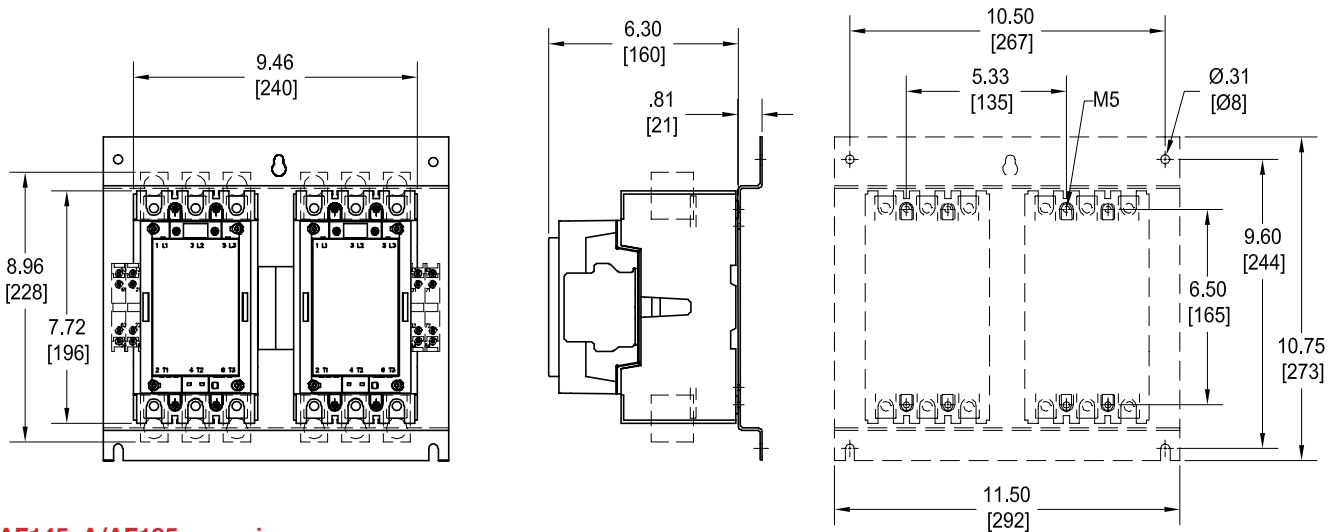

### A/AF145, A/AF185 reversing

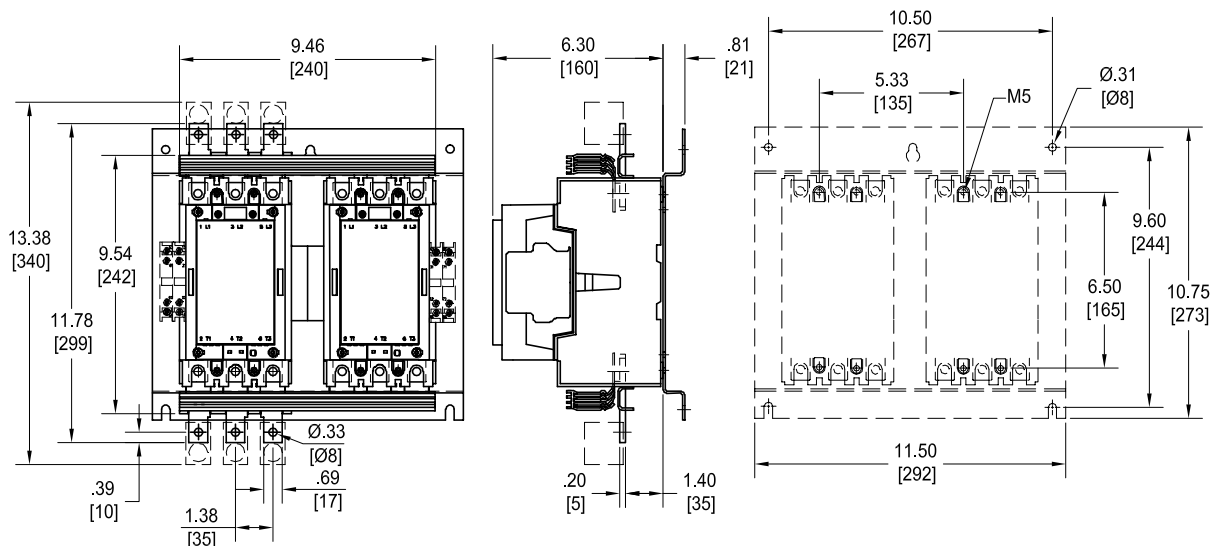

## Approximate dimensions A/AF145 – A/AF300

00.00 Inches  
00.00 [Millimeters]

### A/AF145 – A/AE/AF95-110 mechanically interlocked

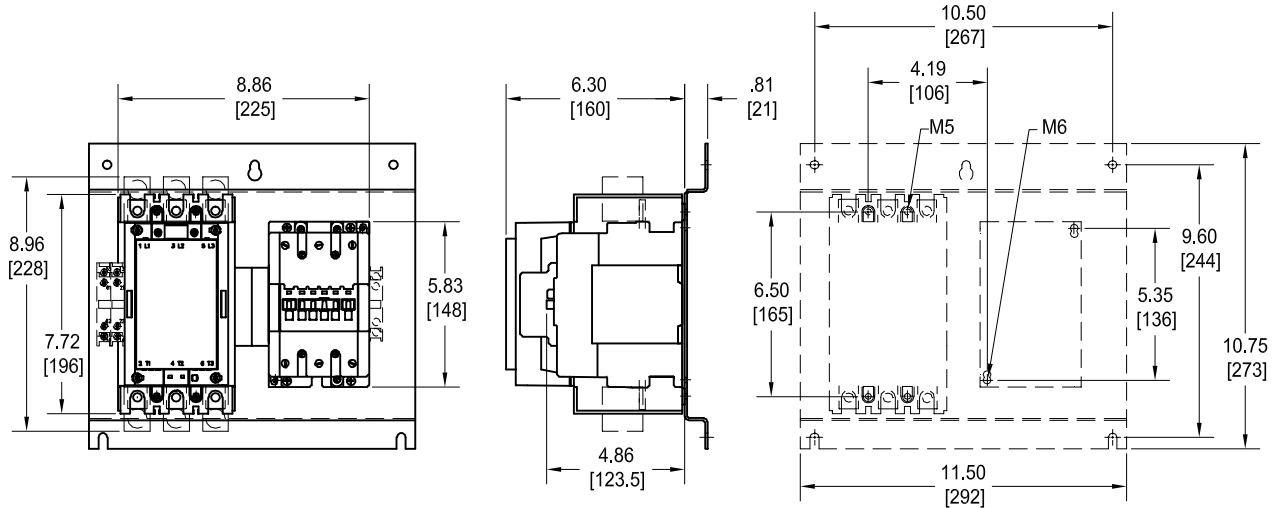

### A/AF210, A/AF260, A/AF300

