



120x120x38 mm

San Ace 120 9G type

General Specifications

- Material Frame: Plastic (Flammability: UL 94V-0), Impeller: Plastic (Flammability: UL 94V-1)
- Expected life See the table below. (L10 life: 90% survival rate for continuous operation in free air at 60°C, rated voltage)
Expected life at 40°C is for reference only.
- Motor protection function Locked rotor burnout protection, Reverse polarity protection
For details, please refer to p. 580.
- Dielectric strength 50/60 Hz, 500 VAC, for 1 minute (between lead wire conductors and frame)
- Insulation resistance 10 MΩ min. at 500 VDC (between lead wire conductors and frame)
- Sound pressure level (SPL) A-weighted sound pressure level (SPL) at 1 m away from the air inlet.
- Storage temperature -30 to +70°C (Non-condensing)
- Lead wire ⊕Red ⊖Black or Blue Sensor Yellow
- Mass 330 g

Specifications

The models listed below **have ribs and pulse sensors**. For models without ribs, append "1" to the end of model numbers.

Model no.	Rated voltage [V]	Operating voltage range [V]	Rated current [A]	Rated input [W]	Rated speed [min ⁻¹]	Max. airflow [m ³ /min] [CFM]	Max. static pressure [Pa] [inchH ₂ O]	SPL [dB (A)]	Operating temperature [°C]	Expected life [h]
9G1212G101	12	10.2 to 13.8	0.98	11.76	3600	3.88 137	135 0.542	49	-20 to +70	40000/60°C (70000/40°C)
9G1212E101			0.61	7.32	3100	3.34 118	100 0.402	46		
9G1212H101			0.38	4.56	2600	2.8 99	70.4 0.283	39		
9G1212F101		7 to 13.8	0.28	3.36	2280	2.45 87	54.2 0.218	36		
9G1212M101			0.21	2.52	1950	2.1 74	39.6 0.159	32		
9G1224G101			24	20.4 to 27.6	0.5	12	3600	3.88 137		
9G1224E101	0.34	8.16			3100	3.34 118	100 0.402	46		
9G1224H101	0.22	5.28			2600	2.8 99	70.4 0.283	39		
9G1224F101	14 to 27.6	0.16		3.84	2280	2.45 87	54.2 0.218	36		
9G1224M101		0.11		2.64	1950	2.1 74	39.6 0.159	32		
9G1248G101		48		40.8 to 55.2	0.25	12	3600	3.88 137		
9G1248E101	0.17		8.16		3100	3.34 118	100 0.402	46		
9G1248H101	0.11		5.28		2600	2.8 99	70.4 0.283	39		
9G1248F101	0.09		4.32		2280	2.45 87	54.2 0.218	36		
9G1248M101	0.07		3.36		1950	2.1 74	39.6 0.159	32		

Note 1: Sensor and control options are available for selection. Refer to the table on p. 606.
 Note 2: The mark indicates Short LeadTime Service applicable models. See p. 630 for details.

Airflow - Static Pressure Characteristics

9G1212G101 With pulse sensor

Operating voltage range

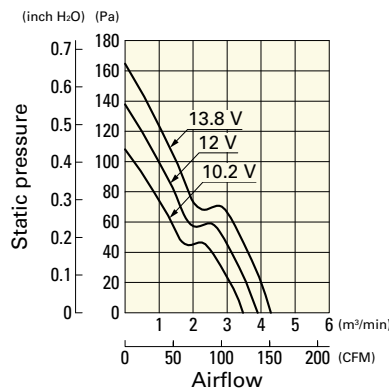

9G1212E101 With pulse sensor

Operating voltage range

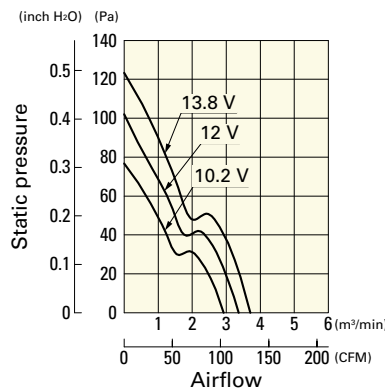

9G1212H101 With pulse sensor

Operating voltage range

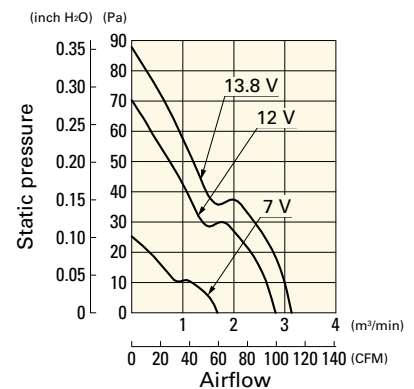

Airflow - Static Pressure Characteristics

9G1212F101 With pulse sensor

Operating voltage range

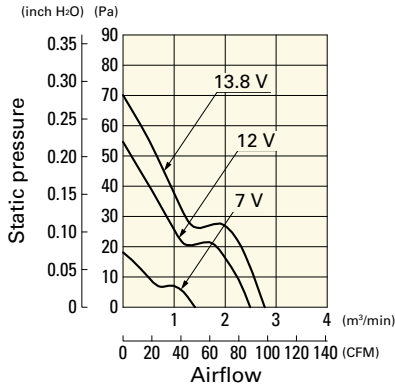

9G1212M101 With pulse sensor

Operating voltage range

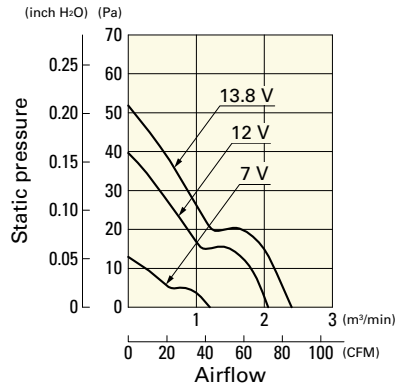

9G1224G101 With pulse sensor

Operating voltage range

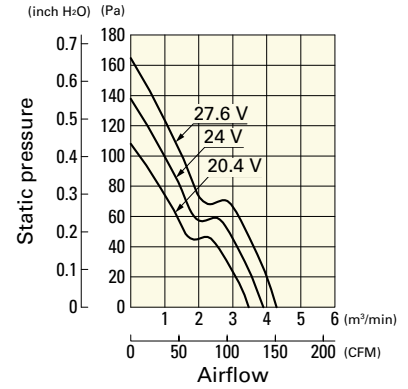

9G1224E101 With pulse sensor

Operating voltage range

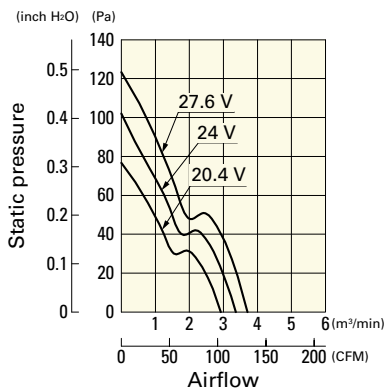

9G1224H101 With pulse sensor

Operating voltage range

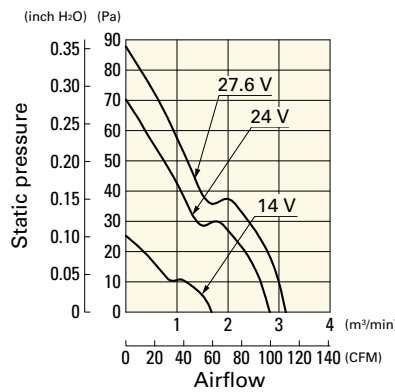

9G1224F101 With pulse sensor

Operating voltage range

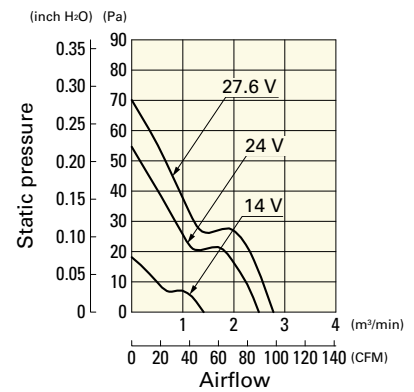

9G1224M101 With pulse sensor

Operating voltage range

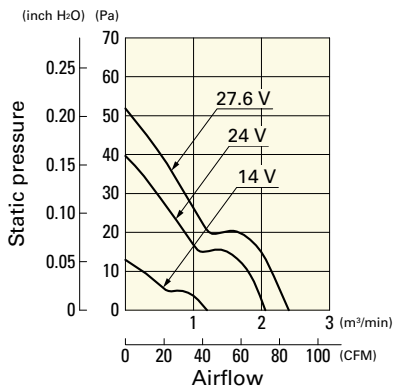

9G1248G101 With pulse sensor

Operating voltage range

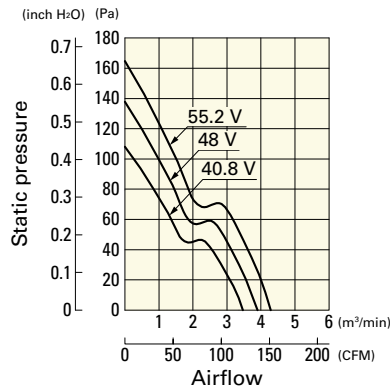

9G1248E101 With pulse sensor

Operating voltage range

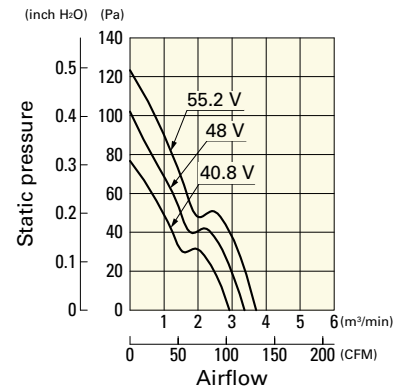

9G1248H101 With pulse sensor

Operating voltage range

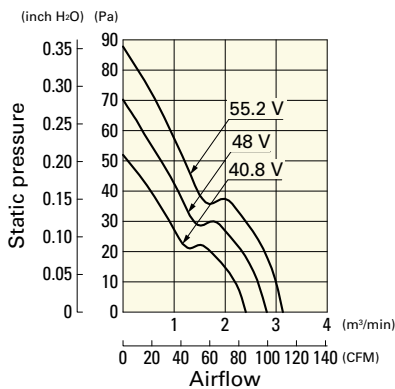

9G1248F101 With pulse sensor

Operating voltage range

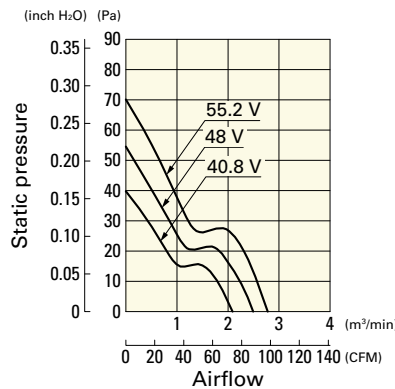

9G1248M101 With pulse sensor

Operating voltage range

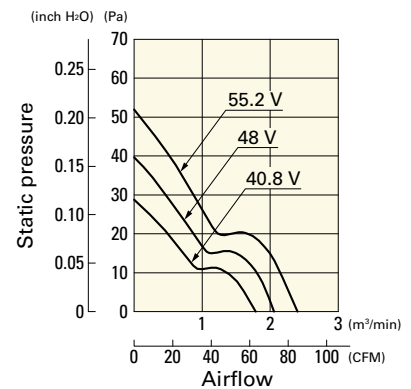

Dimensions (unit: mm) (With ribs)

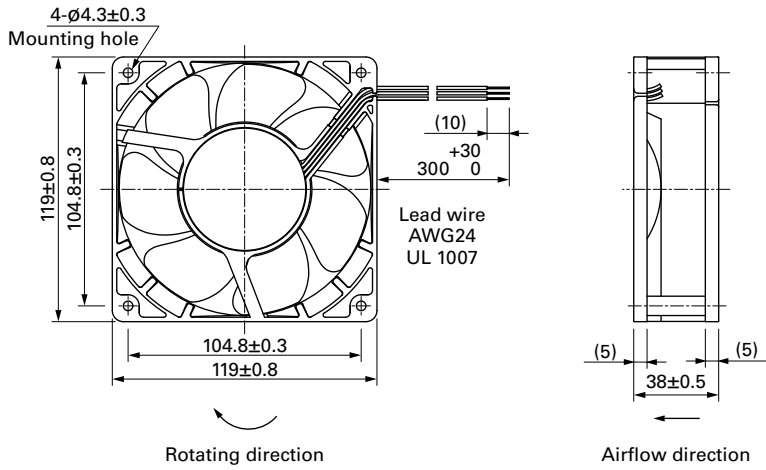

Reference Dimensions of Mounting Holes and Vent Opening (unit: mm)

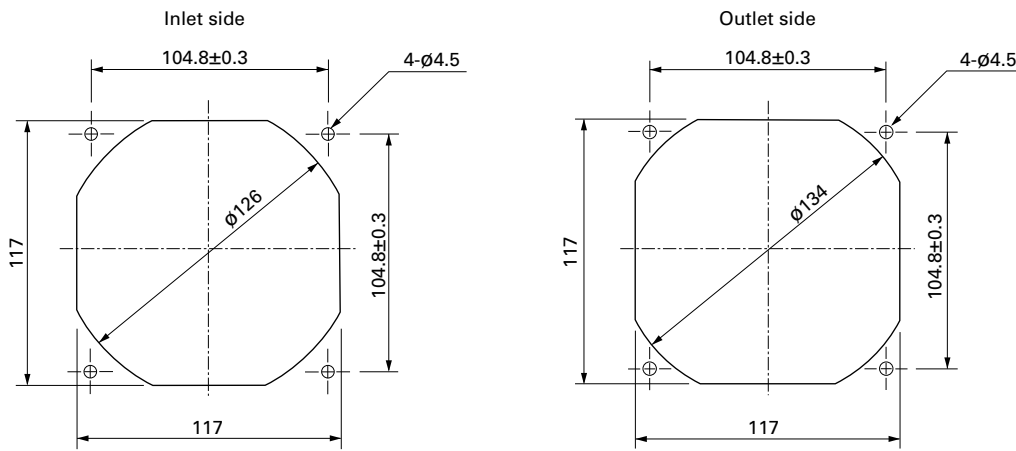

Options

Finger guards

page: p. 565

Model no.: 109-019E, 109-019K, 109-019C, 109-019H

Resin finger guards

page: p. 571

Model no.: 109-1000G

Resin filter kits

page: p. 572

Model no.: 109-1000F13 (13PPI), 109-1000F20 (20PPI),
109-1000F30 (30PPI), 109-1000F40 (40PPI)