

## Introduction – Circuit Protection

Weidmüller's DIN-rail mounted circuit breakers are available for use in applications where circuit protection must be able to distinguish between circuit overloads and short circuits. Each circuit breaker has the ability to be reset without the need to change components. All circuit breakers are available with an assortment of jumpers and marking tags.

Circuit breakers in the 9926 Series are cULus listed according to UL489 and CSA 22.2 No. 5.02, CE, VDE. The hydraulic magnetic trip mechanism offers 10,000A of interrupting capacity in 120V and 240V, 50/60Hz applications.



**9926 Series**

The CB2200 Series feature integrated alarm contacts within a narrow profile, thereby allowing increased enclosure capacity. All of these circuit breakers demonstrate consistent reliability through 100% calibration and testing, and feature a touch safe design to prevent injury from accidental contact with live components.



**CB2200 Series**

The CB4200 Series of thermal magnetic circuit breakers feature a push-button style of trip reset. This reset provides a visual indication of status which allows for rapid troubleshooting.



**CB4200 Series**

The CB9100 Series of thermal magnetic circuit breakers provide a rugged and industry-standard form factor (18 mm/pole). For supplemental circuit protection.



**CB9100 Series**



# 9926 Series Branch Rated Circuit Breakers-AC Version with Contacts

## Circuit Breakers with Auxiliary switch, Trip alarm, Combination of both

- AC voltages (120/240V)
- Single and double pole versions
- cULus listed according to UL489 and C22.2 No. 5.02, CE, VDE
- Factory fitted auxiliary or trip alarm
- Compact 6.5mm width
- Attached to right hand side of circuit breaker

## 9926 Series Single Pole w/ Auxiliary Contact



## 9926 Series Single Pole Trip (Alarm Contact)



## 9926 Series Single Pole Combination (Auxiliary & Alarm Contact)



Technical Data	
Voltage	120/240 VAC, 50/60Hz
Current	
minimum	0.5A
maximum	25A
Interrupting capacity	10,000A
Dielectric strength	1500V, 50/60Hz
Insulation resistance	100MΩ
Operating life	10000
	mechanical operations
Operating temperature	-40...+65°C
Wire size*	
0.5-15A:	14AWG min., 10AWG max.
20-25A:	10AWG min.
Torque	20 in.-lb

**Approval**  
cULus listed according to UL489 and C22.2 No. 5.02, CE, VDE

\*Wire sizes: gauges specified are the minimum allowable as per CSA and UL standards.  
The 9926 circuit breakers do not have provisions for marking tags. A possible solution is to cut the adhesive SchS2 tag rail to length (approximately 20 mm on a single pole unit so the current rating remains visible or approximately 30 mm on a two pole unit). The SchS2 accepts DEK, WS and ESG 8/17 marking tags. The part number for adhesive SchS2 is **1720600000**.

Type: Single Pole Aux (up to 120 VAC)			
Current Ratings (amps)	Part No.	Description	
1	9926261001	QL-A-1-13-DM-KM-1	
2	9926261002	QL-A-1-13-DM-KM-2	
5	9926261005	QL-A-1-13-DM-KM-5	
10	9926261010	QL-A-1-13-DM-KM-10	
15	9926261015	QL-A-1-13-DM-KM-15	
20	9926261020	QL-A-1-13-DM-KM-20	
25	9926261025	QL-A-1-13-DM-KM-25	

Type: Single Pole Trip (up to 120 VAC)			
Current Ratings (amps)	Part No.	Description	
1	9926271001	QL-T-1-13-DM-KM-1	
2	9926271002	QL-T-1-13-DM-KM-2	
5	9926271005	QL-T-1-13-DM-KM-5	
10	9926271010	QL-T-1-13-DM-KM-10	
15	9926271015	QL-T-1-13-DM-KM-15	
20	9926271020	QL-T-1-13-DM-KM-20	
25	9926271025	QL-T-1-13-DM-KM-25	

Type: Single Pole Combo (up to 120 VAC)			
Current Ratings (amps)	Part No.	Description	
1	9926281001	QL-AT-1-13-DM-KM-1	
2	9926281002	QL-AT-1-13-DM-KM-2	
5	9926281005	QL-AT-1-13-DM-KM-5	
10	9926281010	QL-AT-1-13-DM-KM-10	
15	9926281015	QL-AT-1-13-DM-KM-15	
20	9926281020	QL-AT-1-13-DM-KM-20	
25	9926281025	QL-AT-1-13-DM-KM-25	

## 9926 Series Double Pole w/ Auxiliary Contact



## 9926 Series Double Pole Trip (Alarm Contact)



## 9926 Series Double Pole Combination (Auxiliary & Alarm Contact)



Type: Double Pole Aux (up to 240 VAC)			
Current Ratings (amps)	Part No.	Description	
1	9926262001	QL-A-2-13-DM-KM-1	
2	9926262002	QL-A-2-13-DM-KM-2	
5	9926262005	QL-A-2-13-DM-KM-5	
10	9926262010	QL-A-2-13-DM-KM-10	
15	9926262015	QL-A-2-13-DM-KM-15	
20	9926262020	QL-A-2-13-DM-KM-20	
25	9926262025	QL-A-2-13-DM-KM-25	

Type: Double Pole Trip (up to 240 VAC)			
Current Ratings (amps)	Part No.	Description	
1	9926272001	QL-T-2-13-DM-KM-1	
2	9926272002	QL-T-2-13-DM-KM-2	
5	9926272005	QL-T-2-13-DM-KM-5	
10	9926272010	QL-T-2-13-DM-KM-10	
15	9926272015	QL-T-2-13-DM-KM-15	
20	9926272020	QL-T-2-13-DM-KM-20	
25	9926272025	QL-T-2-13-DM-KM-25	

Type: Double Pole Combo (up to 240 VAC)			
Current Ratings (amps)	Part No.	Description	
1	9926282001	QL-AT-2-13-DM-KM-1	
2	9926282002	QL-AT-2-13-DM-KM-2	
5	9926282005	QL-AT-2-13-DM-KM-5	
10	9926282010	QL-AT-2-13-DM-KM-10	
15	9926282015	QL-AT-2-13-DM-KM-15	
20	9926282020	QL-AT-2-13-DM-KM-20	
25	9926282025	QL-AT-2-13-DM-KM-25	

## 9926 Series-AC version Trip Curve

### Trip Curves—Hydraulic Magnetic Type Typical time/current characteristics at 30°C

Additional trip curves and amp ratings are available upon request.

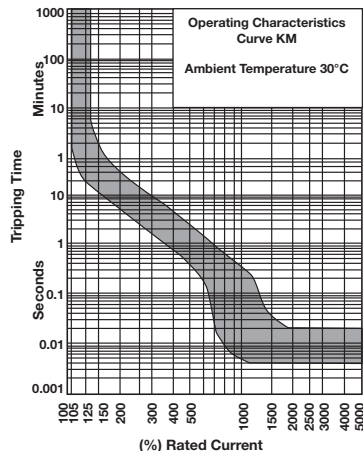

## Dual Mount Dimensions in mm (in.)

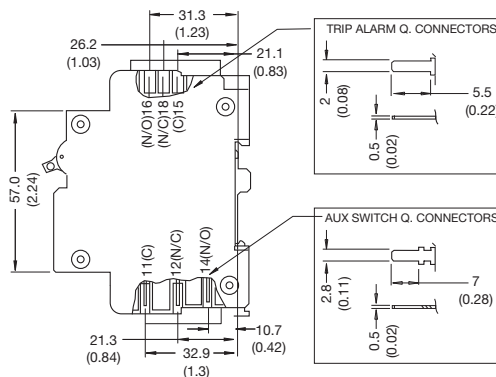



# 9926 Series Supplemental Circuit Breakers

## Circuit Breakers Hydraulic Magnetic Type

- AC Voltages 277/480V
- Trip curve 2 for general purpose applications
- UL 1077 recognized
- VDE approved and CE marked
- Just 13 mm wide
- Mounts to 35 mm DIN-rail
- Factory fitted auxiliary or trip alarm
- Single, double and triple pole versions

## 9926 Series Single Pole



## 9926 Series Double Pole



## 9926 Series Triple Pole



### Ordering Data

### Type: Single Pole (up to 277 VAC)

Current Rating (amps)	Part No.	Description
1	9926251501	QZ-1-13-D-2-01
2	9926251502	QZ-1-13-D-2-02
3	9926251503	QZ-1-13-D-2-03
4	9926251504	QZ-1-13-D-2-04
5	9926251505	QZ-1-13-D-2-05
6	9926251506	QZ-1-13-D-2-06
8	9926251508	QZ-1-13-D-2-08
10	9926251510	QZ-1-13-D-2-10
15	9926251515	QZ-1-13-D-2-15
20	9926251520	QZ-1-13-D-2-20
25	9926251525	QZ-1-13-D-2-25
35	9926251535	QZ-1-13-D-2-35
40	9926251540	QZ-1-13-D-2-40
50	9926251550	QZ-1-13-D-2-50
60	9926251560	QZ-1-13-D-2-60

### Type: Double Pole (up to 480 VAC)

Current Rating (amps)	Part No.	Description
1	9926252501	QZ-2-13-D-2-01
2	9926252502	QZ-2-13-D-2-02
4	9926252504	QZ-2-13-D-2-04
5	9926252505	QZ-2-13-D-2-05
6	9926252506	QZ-2-13-D-2-06
10	9926252510	QZ-2-13-D-2-10
15	9926252515	QZ-2-13-D-2-15
20	9926252520	QZ-2-13-D-2-20
25	9926252525	QZ-2-13-D-2-25
30	9926252530	QZ-2-13-D-2-30
35	9926252535	QZ-2-13-D-2-35
40	9926252540	QZ-2-13-D-2-40
50	9926252550	QZ-2-13-D-2-50
60	9926252560	QZ-2-13-D-2-60

### Type: Triple Pole (up to 480 VAC)

Current Rating (amps)	Part No.	Description
10	9926253510	QZ-3-13-D-2-10
15	9926253515	QZ-3-13-D-2-15
20	9926253520	QZ-3-13-D-2-20
25	9926253525	QZ-3-13-D-2-25
30	9926253530	QZ-3-13-D-2-30
40	9926253540	QZ-3-13-D-2-40
50	9926253550	QZ-3-13-D-2-50
60	9926253560	QZ-3-13-D-2-60

## Accessories

Type	Part No.
Bus bar (1 pole, insulated 1m)	67101904
Bus bar (2 pole, insulated 1m)	67101972
Bus bar (3 pole, insulated 1m)	67101971
Bus bar end cap, 1 pole	67101973
Bus bar end cap, 2 pole or 3 pole	67101974
Power lug, straight	67101960
Power lug, 90°	67101961
Lock-out handle	67101913

### 9926 Series Supplemental – dimensions in mm (in.)

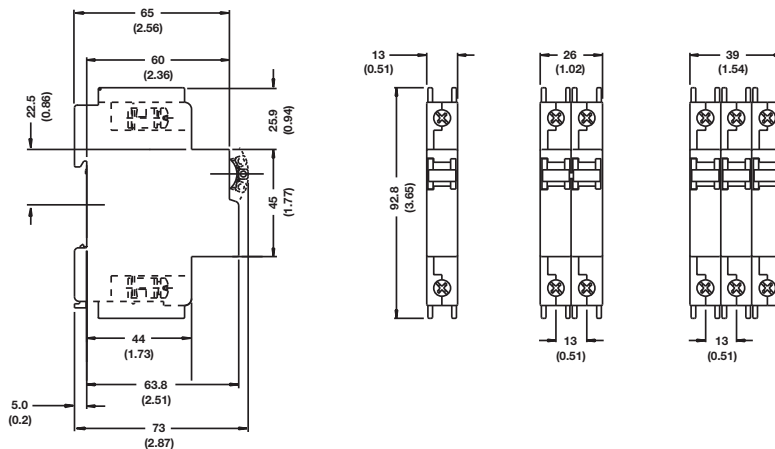

### Technical Data

Voltage	277/480 VAC @ 50/60 Hz
Current	
minimum	0.5 A
maximum	60 A
Interrupting capacity	5 kA @ 277/480 V, 5 kA @ 120 V, 5 kA @ 240 V
Dielectric strength	1500 V, 50/60 Hz
Insulation resistance	100 MΩ
Operating life	10000 mechanical operations
Operating temperature	-40...+65°C
Wire size*	
1-15A:	14 AWG min., 10 AWG max.
20-25A:	10 AWG min.
Torque	20 in.-lb

### Approval

†UL 1077 Recognized, VDE (EN 60947-2) Approved, CSA C22.2 No. 235, CE Marked

\*Wire sizes: gauges specified are the minimum allowable as per CSA and UL standards.

The 9926 circuit breakers do not have provisions for marking tags. A possible solution is to cut the adhesive SchS2 tag rail to length (approximately 20 mm on a single pole unit so the current rating remains visible or approximately 30 mm on a two pole unit). The SchS2 accepts DEK, WS and ESG 8/17 marking tags.

The part number for adhesive SchS2 is **1720600000**.

†cURus recognized to UL1077 and C22.2 No. 235

### 9926 Series—Supplemental Trip Curve

## Trip Curves—Hydraulic Magnetic Type Typical time/current characteristics at 30°C

Additional trip curves and amp ratings are available upon request.

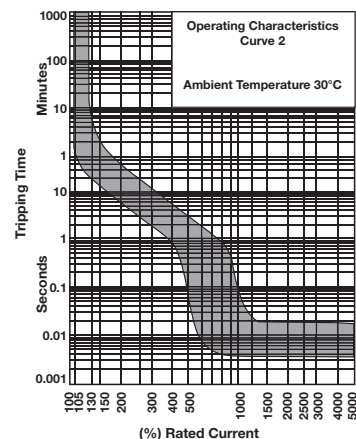

# 9926 Series Supplemental Circuit Breakers with Contacts

## Circuit Breakers Auxiliary switch, Trip alarm, Combination of both

- AC Voltages 277/480V
- Trip curve 2 for general purpose applications
- UL 1077 recognized
- VDE approved and CE marked
- Just 13 mm wide
- Mounts to 35 mm DIN-rail
- Factory fitted auxiliary or trip alarm
- Single, double and triple pole versions

### Technical Data

Voltage	277/480 VAC @ 50/60 Hz	
Current	minimum	0.5 A
	maximum	60 A
Interrupting capacity	5 kA @ 277/480 V, 5 kA @ 120 V, 5 kA @ 240 V	
Dielectric strength	1500 V, 50/60 Hz	
Insulation resistance	100 MΩ	
Operating life	10000 mechanical operations	
Operating temperature	-40...+65°C	
Wire size*		
	1-15A:	14 AWG min., 10 AWG max.
	20-25A:	10 AWG min.
Torque	20 in.-lb	

### Approval

†UL 1077 Recognized, VDE (EN 60947-2)  
Approved, CSA C22.2 No. 235, CE Marked

\*Wire sizes: gauges specified are the minimum allowable as per CSA and UL standards.

The 9926 circuit breakers do not have provisions for marking tags. A possible solution is to cut the adhesive SchS2 tag rail to length (approximately 20 mm on a single pole unit so the current rating remains visible or approximately 30 mm on a two pole unit). The SchS2 accepts DEK, WS and ESG B/17 marking tags. The part number for adhesive SchS2 is 1720600000.

### 9926 Series—Supplemental Trip Curve

## Trip Curves—Hydraulic Magnetic Type Typical time/current characteristics at 30°C

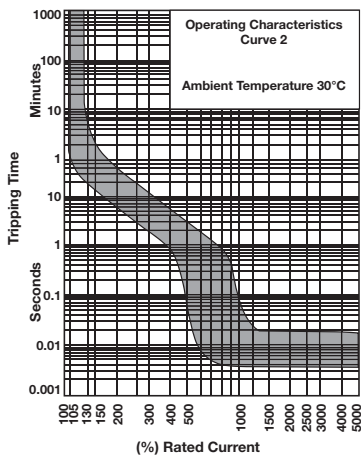

## 9926 Series Single Pole w/ Auxiliary Contact



### Type: Single Pole Aux (up to 277 VAC)

Current Ratings (amps)	Part No.	Description
1	9926261501	QZ-A-1-13-D-2-01
2	9926261502	QZ-A-1-13-D-2-02
5	9926261505	QZ-A-1-13-D-2-05
10	9926261510	QZ-A-1-13-D-2-10
15	9926261515	QZ-A-1-13-D-2-15
20	9926261520	QZ-A-1-13-D-2-20
25	9926261525	QZ-A-1-13-D-2-25

## 9926 Series Single Pole Trip (Alarm Contact)



### Type: Single Pole Trip (up to 277 VAC)

Current Ratings (amps)	Part No.	Description
1	9926271501	QZ-T-1-13-D-2-01
2	9926271502	QZ-T-1-13-D-2-02
5	9926271505	QZ-T-1-13-D-2-05
10	9926271510	QZ-T-1-13-D-2-10
15	9926271515	QZ-T-1-13-D-2-15
20	9926271520	QZ-T-1-13-D-2-20
25	9926271525	QZ-T-1-13-D-2-25

## 9926 Series Single Pole Combination (Auxiliary & Alarm Contact)



### Type: Single Pole Combo (up to 277 VAC)

Current Ratings (amps)	Part No.	Description
1	9926281501	QZ-AT-1-13-D-2-01
2	9926281502	QZ-AT-1-13-D-2-02
5	9926281505	QZ-AT-1-13-D-2-05
10	9926281510	QZ-AT-1-13-D-2-10
15	9926281515	QZ-AT-1-13-D-2-15
20	9926281520	QZ-AT-1-13-D-2-20
25	9926281525	QZ-AT-1-13-D-2-25

## 9926 Series Double Pole w/ Auxiliary Contact



### Type: Double Pole Aux (up to 480 VAC)

Current Ratings (amps)	Part No.	Description
1	9926262501	QZ-A-2-13-D-2-01
2	9926262502	QZ-A-2-13-D-2-02
5	9926262505	QZ-A-2-13-D-2-05
10	9926262510	QZ-A-2-13-D-2-10
15	9926262515	QZ-A-2-13-D-2-15
20	9926262520	QZ-A-2-13-D-2-20
25	9926262525	QZ-A-2-13-D-2-25

## 9926 Series Double Pole Trip (Alarm Contact)



### Type: Double Pole Trip (up to 480 VAC)

Current Ratings (amps)	Part No.	Description
1	9926272501	QZ-T-2-13-D-2-01
2	9926272502	QZ-T-2-13-D-2-02
5	9926272505	QZ-T-2-13-D-2-05
10	9926272510	QZ-T-2-13-D-2-10
15	9926272515	QZ-T-2-13-D-2-15
20	9926272520	QZ-T-2-13-D-2-20
25	9926272525	QZ-T-2-13-D-2-25

## 9926 Series Double Pole Combination (Auxiliary & Alarm Contact)



### Type: Double Pole Combo (up to 480 VAC)

Current Ratings (amps)	Part No.	Description
1	9926282501	QZ-AT-2-13-D-2-01
2	9926282502	QZ-AT-2-13-D-2-02
5	9926282505	QZ-AT-2-13-D-2-05
10	9926282510	QZ-AT-2-13-D-2-10
15	9926282515	QZ-AT-2-13-D-2-15
20	9926282520	QZ-AT-2-13-D-2-20
25	9926282525	QZ-AT-2-13-D-2-25

## 9926 Series Triple Pole w/ Auxiliary Contact



### Type: Triple Pole Aux (up to 480 VAC)

Current Ratings (amps)	Part No.	Description
1	9926263501	QZ-A-3-13-D-2-01
2	9926263502	QZ-A-3-13-D-2-02
5	9926263505	QZ-A-3-13-D-2-05
10	9926263510	QZ-A-3-13-D-2-10
15	9926263515	QZ-A-3-13-D-2-15
20	9926263520	QZ-A-3-13-D-2-20
25	9926263525	QZ-A-3-13-D-2-25

## 9926 Series Triple Pole Trip (Alarm Contact)



### Type: Triple Pole Trip (up to 480 VAC)

Current Ratings (amps)	Part No.	Description
1	9926273501	QZ-T-3-13-D-2-01
2	9926273502	QZ-T-3-13-D-2-02
5	9926273505	QZ-T-3-13-D-2-05
10	9926273510	QZ-T-3-13-D-2-10
15	9926273515	QZ-T-3-13-D-2-15
20	9926273520	QZ-T-3-13-D-2-20
25	9926273525	QZ-T-3-13-D-2-25

## 9926 Series Triple Pole Combination (Auxiliary & Alarm Contact)



### Type: Triple Pole Combo (up to 480 VAC)

Current Ratings (amps)	Part No.	Description
1	9926283501	QZ-AT-3-13-D-2-01
2	9926283502	QZ-AT-3-13-D-2-02
5	9926283505	QZ-AT-3-13-D-2-05
10	9926283510	QZ-AT-3-13-D-2-10
15	9926283515	QZ-AT-3-13-D-2-15
20	9926283520	QZ-AT-3-13-D-2-20
25	9926283525	QZ-AT-3-13-D-2-25

†cURus recognized to UL1077 and C22.2 No. 235



# 9926 Series Supplemental Circuit Breakers–GFCI

## Ground Fault Current Interrupt

- CE approved
- UL1077 and UL1053 recognized
- Small frame size (26mm wide)
- Single pole plus switched neutral ground leakage protection
- Trip point is unaffected by ambient temperature
- Current ratings up to 50A
- Trip indication (mid trip handle position)
- Trip curve 2 for general purpose applications

## 9926 Series GFCI



### Ordering Data

### Technical Data

Standard Ampere Ratings (A)	5 to 50A
Sensitivity (mA)	30 (CE) / 22 (UL)
Number of Poles	1 + N
Equipment Type	Ground Leakage/GFCI
Rated Voltage (V)	230 (CE) / 240 (UL)
Rated Interrupting/	5 kA
Withstand Capacity (kA)	-
Weight (kg)	0.26
Trip Curve (standard)	2
Operating Temperature	-40 to +65°C

### Approval

UL 1077 and UL 1053, CE

### Type: Single Pole GFCI

Current Ratings (amps)	Part No.	Description
5	9926291105	QF17A2505 - CB W/GFI
10	9926291110	QF17A2510 - CB W/GFI
15	9926291115	QF17A2515 - CB W/GFI
20	9926291120	QF17A2520 - CB W/GFI
25	9926291125	QF17A2525 - CB W/GFI
30	9926291130	QF17A2530 - CB W/GFI
50	9926291150	QF17A2550 - CB W/GFI

### 9926 Series–AC version Trip Curve

### Trip Curves—Hydraulic Magnetic Type Typical time/current characteristics at 30°C

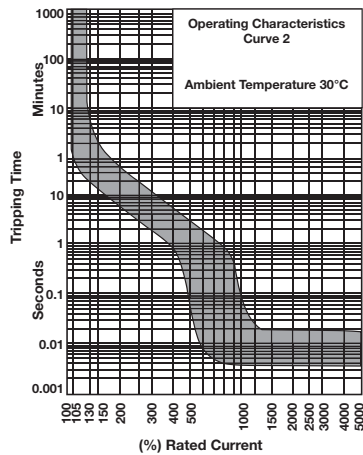

### 9926 Series GFCI – dimensions in mm (in.)

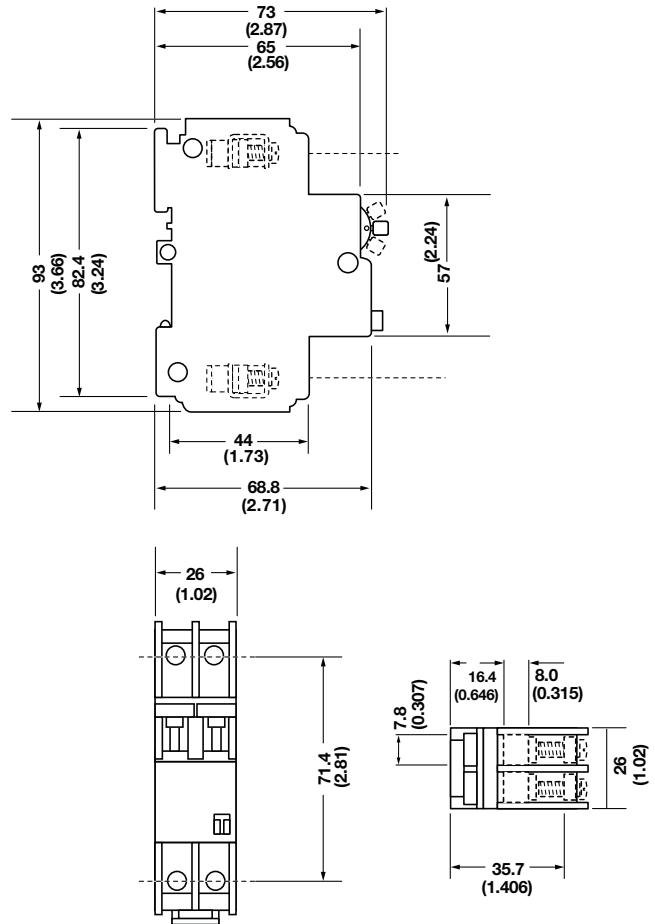

# 9926 Series Mounting Options and Accessories

## Mounting Options

If the product is not vertically mounted in the normal DIN-rail mounting orientation, a rating factor must be applied. Figure 1 shows a diagram of the rating factor to apply. The published curves for these circuit breaker products are produced with the circuit breaker in the vertical mounting position. The rating factor only applies to the must hold and must trip points of the curve as the other parts (instantaneous trip point) stay largely unaffected.

It is important to note that in environments that are exposed to a high degree of vibration, the cables that connect to the circuit breaker must be securely held in place, as the breaker is not designed to carry the weight of the cables. A maximum of 35N can be applied to the terminal area, in a direction perpendicular to the mounting axis.

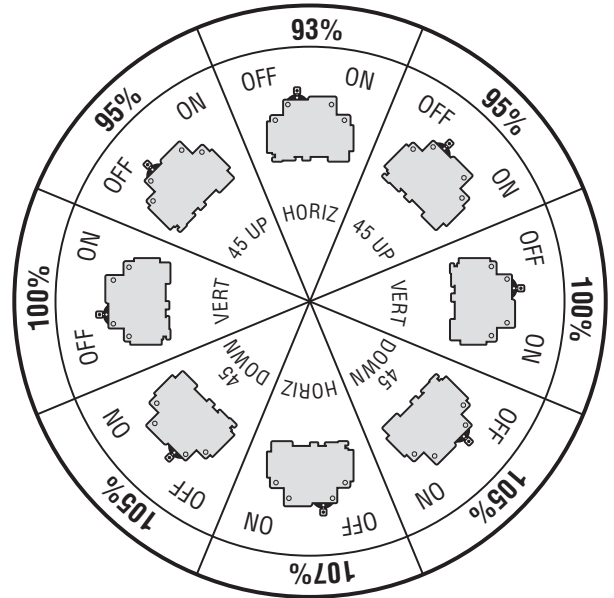

## Accessories

Technical Data	
Current Rating	80A max.
Voltage	500V max.
Short Circuit Strength	25kA

Type	Part No.
Bus bar (1 pole, insulated 1m)	67101904
Bus bar (2 pole, insulated 1m)	67101972
Bus bar (3 pole, insulated 1m)	67101971

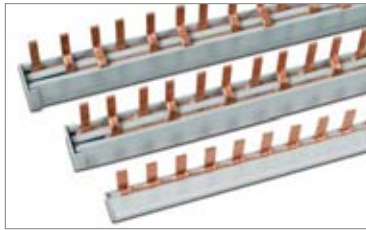

Type	Part No.
Bus bar end cap, 1 pole	67101973
Bus bar end cap, 2 pole or 3 pole	67101974



Technical Data	
Current Rating	85A max.
Wire Size	10 AWG min., 4 AWG max.
Dimensions	A: 6 mm B: 32 mm

Type	Part No.
Power lug, straight	67101960
Power lug, 90°	67101961



Type	Part No.
Lock-out handle	67101913

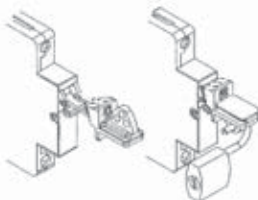

## Part Number Table - Example

To order 9926 Series Single Pole Circuit Breaker  
Part No. 9926251000

- Current Rating of 1.0 amp
- Internal Resistance per Pole of 1.1 ohms
- Trip Curve – M1, Medium (Standard)

9 9 2 6 2 5 1 0 0 0

### Amperage

- \*00\* - 0.5A
- \*01\* - 1A
- \*02\* - 2A
- /
- \*60\* - 60A

### Trip Curves (Types 5-9)

- \*0\* - Branch AC KM (Standard)
- \*1\* - Branch AC OP (Instantaneous)
- \*2\* - Branch AC 1 (Fast)
- \*3\* - Supplemental 9 (Slow)
- \*4\* - Branch 80VDC 1 (Fast)
- \*5\* - Supplemental 2 (Standard)
- \*6\* - Branch 125VDC OP (Instantaneous)
- \*7\* - Branch 80VDC OP (Instantaneous)
- \*8\* - Branch 125VDC U2 (Standard)
- \*9\* - Branch 80VDC U2 (Standard)

### Poles

- 1 Pole
- 2 Pole
- 3 Pole

### Type

- \*5\* - Base Breaker
- \*6\* - With Auxiliary Contact
- \*7\* - With Trip Alarm Contact
- \*8\* - Combo Aux/Trip Contact
- \*9\* - GFCI

9 9 2 6 2 4 1 0 0 0

### Amperage

- \*00\* - 0.5A
- \*01\* - 1A
- \*02\* - 2A
- /
- \*60\* - 60A

### Trip Curves (Type 4)

- \*0\* - Supplemental 1 (Fast)

### Poles

- 1 Pole
- 2 Pole
- 3 Pole

### Type

- \*4\* - Base Breaker



# CB4200 Series Supplemental Circuit Breakers

## Circuit Breakers Thermal Magnetic Type

- Rated from 0.05 to 16.0 amps
- Available in single or double pole configurations
- Features a tease free design to reduce contact damage
- Offers push button trip/reset function
- Trip free design means the breaker cannot be held closed against a fault
- Mounts on 32mm\* or 35mm DIN-rail
- UL 1077 recognized

## CB4200 Series Single Pole



## CB4200 Series Double Pole



### Ordering Data

Current Ratings (amps)	Part No. TS 35 *For TS 32 Rail, see adapter below
0.05	9124083500
0.08	9124653500
0.1	9104173500
0.2	9104183500
0.3	9129813500
0.4	9124093500
0.5	9101003500
0.6	9124113500
0.7	9129563500
0.8	9101103500
1.0	9101203500
1.2	9101303500
1.3	9124123500
1.4	9124133500
1.5	9101403500
1.8	9124143500
2.0	9101503500
2.5	9101603500
3.0	9101703500
3.5	9124163500
4.0	9104353500
4.5	9124173500
5.0	9101803500
5.5	9107833500
6.0	9103813500
6.5	9120043500
7.0	9104153500
8.0	9103003500
9.0	9104613500
10.0	9101903500
11.0	9124183500
12.0	9107843500
13.0	9124193500
14.0	9107853500
15.0	9102003500
16.0	9124213500

### Type: Single Pole

Current Ratings (amps)	Part No. TS 35 *For TS 32 Rail, see adapter below
0.05	9124223500
0.08	9124233500
0.1	9120353500
0.2	9124243500
0.3	9124263500
0.4	9124273500
0.5	9129583500
0.6	9124283500
0.7	9124293500
0.8	9129593500
1.0	9129613500
1.2	9129623500
1.3	9124313500
1.4	9124323500
1.5	9129633500
1.8	9124333500
2.0	9129643500
2.5	9129653500
3.0	9129663500
3.5	9124343500
4.0	9129713500
4.5	9124353500
5.0	9129673500
5.5	9124363500
6.0	9124373500
6.5	9124383500
7.0	9124393500
8.0	9104673500
9.0	9124423500
10.0	9129683500
11.0	9124433500
12.0	9124443500
13.0	9124453500
14.0	9124463500
15.0	9129693500
16.0	9124473500

### Type: Double Pole

Current Ratings (amps)	Part No. TS 35 *For TS 32 Rail, see adapter below
0.05	9124223500
0.08	9124233500
0.1	9120353500
0.2	9124243500
0.3	9124263500
0.4	9124273500
0.5	9129583500
0.6	9124283500
0.7	9124293500
0.8	9129593500
1.0	9129613500
1.2	9129623500
1.3	9124313500
1.4	9124323500
1.5	9129633500
1.8	9124333500
2.0	9129643500
2.5	9129653500
3.0	9129663500
3.5	9124343500
4.0	9129713500
4.5	9124353500
5.0	9129673500
5.5	9124363500
6.0	9124373500
6.5	9124383500
7.0	9124393500
8.0	9104673500
9.0	9124423500
10.0	9129683500
11.0	9124433500
12.0	9124443500
13.0	9124453500
14.0	9124463500
15.0	9129693500
16.0	9124473500

## Trip Curves Thermal Magnetic Type Typical time/current characteristics at 23°C

### CB4200 Series

#### M1+ 0.05 to 7.5 A

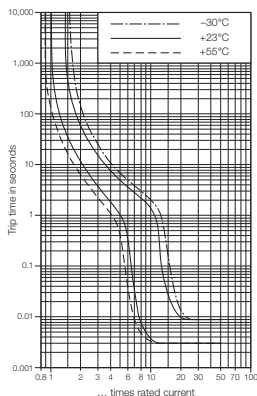

#### M1+ 8 to 16 A

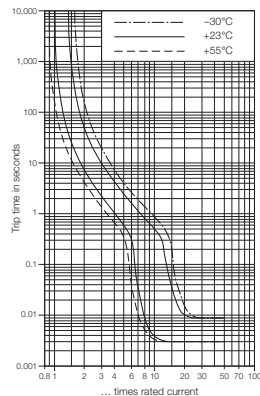

### \*Adapter foot – dimensions in mm (in.)

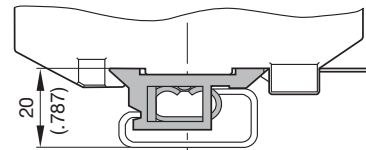

9102100000  
TS32 adapter

# CB4200 Series Supplemental Circuit Breakers

## CB4200 Series Single Pole

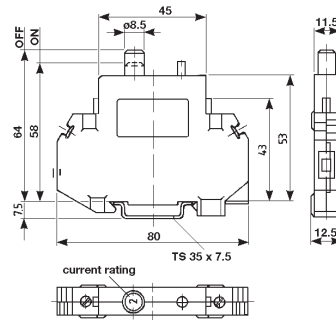

## Internal Wiring Diagram

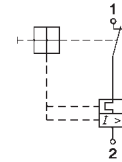

Dimensions in mm

## CB4200 Series Double Pole

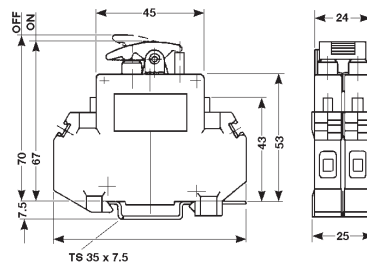

## Internal Wiring Diagram

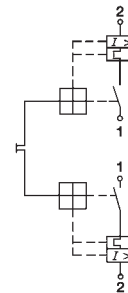

Dimensions in mm

### Technical Data

Rated voltage & current†	UL
	CSA
	VDE
Creepage resistance	
Dielectric strength	
Insulation resistance	
Interrupting capacity (VDE 0660, Part 101, P-2)	
Interrupting capacity; 4201 (UL 1077/EN 60934 PC1)	
Typical life at 2 x rated current	
Shock	
Torque	
Vibration	
Temperature range	
Corrosion	
Humidity	
Weight	
Wire size (UL)	

Voltage Ratings		Current Ratings	
AC 250 V, DC 65 V, 50/60 Hz		0.05...16 A	
AC 250 V, DC 65 V, 50/60 Hz		0.05...16 A	
AC 250 V, DC 65 V, 50/60 Hz		0.05...16 A	
PTI 600 to IEC 112			
4,000 VAC; IEC 664 & 664 A			
> 100 MΩ (DC 500 V)			
4201-10	Maximum capacity		
0.05...0.8 A	Self-limiting		
1...2 A	200 A		
2.5...16 A	400 A		
Rated current	Rated voltage	Maximum capacity	
0.05...2.0 A	AC 250 V	200 A	
2.0...16 A	AC 250 V	200 A	
20 A	AC 125 V	400 A	

5,000 operations
25 g (11 ms) to IEC 68-2-27, Test Ea
1.2 Nm
5 g (57 to 500 Hz / ±0.38 mm, 10 to 57 Hz) to IEC 68-2-6, Test Fc
-30°C...+55°C (-22°F...+131°F)
96 hours at 5% salt spray, to IEC 68-2-11, Test Ka
240 hours at 95% RH, to IEC 68-2-3, Test Ca
60 g per pole
#20...8 AWG solid/0.5...6 mm²

### Accessories

Jumpers	
	Daisy Chain 50*
	Straight CQB**
	insulated
	Angled CQB**
	insulated
Adapter foot (for TS 32 Rail)	

Type	Part No.
BDC 50	9970290000
CQB 2	9970560000
CQB 3	9970570000
CQB 4	9970580000
CQB 10	9970590000
CQB 2	9970600000
CQB 3	9970610000
CQB 4	9970620000
CQB 10	9970630000
MCBAF/TS 32	9102100000

### Marking Tags

Note: Part numbers are shown for a single card of pre-printed tags numbered 1-50.	Special print only
	Consecutive horizontal
	Consecutive vertical

WS 8/5 MC	1640750000***
DEK 5/5	0473460001
DEK 5/5	0473560001

†Note: Resistive and inductive loads (0.05 - 16 A)  
 \*BDC will accommodate 20 A per pin, 20 A total  
 \*\*CQB will accommodate 18 A per pin, 18 A total; dedicated to 4201 Series  
 \*\*\*Please specify horizontal or vertical print when ordering.  
 Standard quantity = 144 tags per card.

# CB2200 Series Supplemental Circuit Breakers

## Circuit Breakers Thermal Magnetic Type

- Rated from 0.1 to 32.0 amps
- Available in single, double and triple pole configurations
- Offers normally open (N/O) and normally closed (N/C) auxiliary contacts
- Lever-switch trip/reset function
- Mounts on 32mm or 35mm DIN-rail
- UL 1077 recognized

## CB2200 Series Single Pole



## CB2200 Series Double Pole



## CB2200 Series Triple Pole



Ordering Data	Type: Single Pole*		Type: Double Pole		Type: Triple Pole	
	Current Ratings (amps)	N/O Aux. Part No.	Current Ratings (amps)	N/O-N/C Part No.	Current Ratings (amps)	N/O-N/C Part No.
	0.1	9911010005	0.1	9912010003	0.1	9913010003
	0.2	9911020005	0.2	9912020003	0.2	9913020003
	0.3	9911030005	0.3	9912030003	0.3	9913030003
	0.4	9911040005	0.4	9912040003	0.4	9913040003
	0.5	9911050005	0.5	9912050003	0.5	9913050003
	0.6	9911060005	0.6	9912060003	0.6	9913060003
	0.8	9911080005	0.8	9912080003	0.8	9913080003
	1.0	9911100005	1.0	9912100003	1.0	9913100003
	1.5	9911150005	1.5	9912150003	1.5	9913150003
	2.0	9911200005	2.0	9912200003	2.0	9913200003
	2.5	9911250005	2.5	9912250003	2.5	9913250003
	3.0	9911300005	3.0	9912300003	3.0	9913300003
	4.0	9911400005	4.0	9912400003	4.0	9913400003
	5.0	9911500005	5.0	9912500003	5.0	9913500003
	6.0	9911600005	6.0	9912600003	6.0	9913600003
	8.0	9911800005	8.0	9912800003	8.0	9913800003
	10	9921100005	10	9922100003	10	9923100003
	12	9921120005	12	9922120003	12	9923120003
	15	9921150005	15	9922150003	15	9923150003
	16	9921160005	16	9922160003	16	9923160003
	18	9921180005	18	9922180003	18	9923180003
	20	9921200005	20	9922200003	20	9923200003
	25	9921250005				
	32	9921320005				

\*All part numbers with N/O Auxiliary Contacts on each pole when the main breaker contact is open (in the OFF position)

Ordering Data	Type: Single Pole		Type: Double Pole		Type: Triple Pole	
	Current Ratings (amps)	Part No.	Current Ratings (amps)	Part No.	Current Ratings (amps)	Part No.
	0.1	9911010000	0.1	9912010000	0.1	9913010000
	0.2	9911020000	0.2	9912020000	0.2	9913020000
	0.3	9911030000	0.3	9912030000	0.3	9913030000
	0.4	9911040000	0.4	9912040000	0.4	9913040000
	0.5	9911050000	0.5	9912050000	0.5	9913050000
	0.6	9911060000	0.6	9912060000	0.6	9913060000
	0.8	9911080000	0.8	9912080000	0.8	9913080000
	1.0	9911100000	1.0	9912100000	1.0	9913100000
	1.5	9911150000	1.5	9912150000	1.5	9913150000
	2.0	9911200000	2.0	9912200000	2.0	9913200000
	2.5	9911250000	2.5	9912250000	2.5	9913250000
	3.0	9911300000	3.0	9912300000	3.0	9913300000
	4.0	9911400000	4.0	9912400000	4.0	9913400000
	5.0	9911500000	5.0	9912500000	5.0	9913500000
	6.0	9911600000	6.0	9912600000	6.0	9913600000
	8.0	9911800000	8.0	9912800000	8.0	9913800000
	10	9921100000	10	9922100000	10	9923100000
	12	9921120000	12	9922120000	12	9923120000
	15	9921150000	15	9922150000	15	9923150000
	16	9921160000	16	9922160000	16	9923160000
	18	9921180000	18	9922180000	18	9923180000
	20	9921200000	20	9922200000	20	9923200000
	25	9921250000	25	9922250000	25	9923250000
	32	9921320000	32	9922320000	32	9923320000

# CB2200 Series Supplemental Circuit Breakers

## CB2200 Series

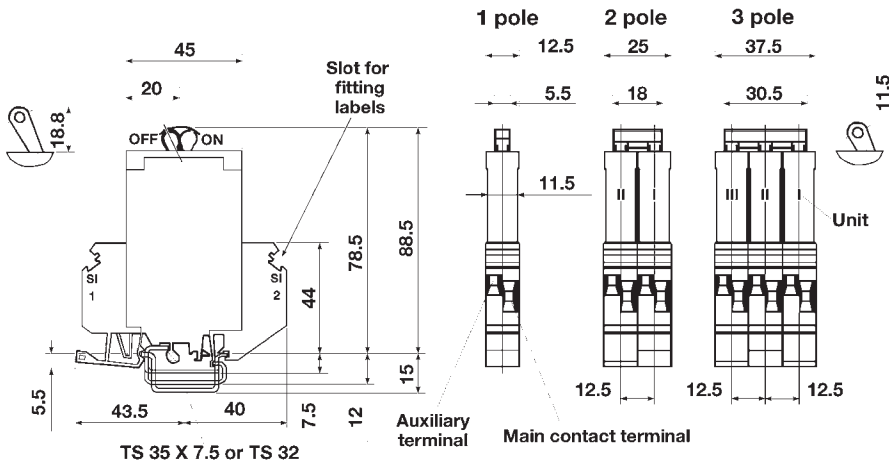

Dimensions in mm

### Technical Data

Rated voltage & current†

UL
CSA
VDE

Auxiliary contacts	250 VAC / 65 VDC, 1 A
Creepage resistance	PTI 600 to IEC 112
Dielectric strength	3,000 VAC; IEC 664 & 664 A
Insulation resistance	> 100 MΩ (DC 500 V)

Interrupting capacity  
(VDE 0660, Part 101, P-2)

Interrupting capacity  
(UL 1077/EN 60934 PC1)

Typical life at 2 x rated current	5,000 operations
Shock	25 g (11 ms) to IEC 68-2-27, Test Ea
Torque	0.6 (5.3) Nm (lb. in.) Auxiliary contact: 0.5 (4.4)
Vibration	5 g (57 to 500 Hz / ±0.38 mm, 10 to 57 Hz) to IEC 68-2-6, Test Fc
Temperature range	-30...+60°C (-22°F...+140°F)
Corrosion	96 hours at 5% salt spray, to IEC 68-2-11, Test Ka
Humidity	240 hours at 95% RH, to IEC 68-2-3, Test Ca
Weight	Approximately 60 g per pole
Wire size (UL)	max 6 mm²...8 AWG max 1.5 mm²...14 AWG (Aux. contact)

### Accessories

Jumpers	Daisy Chain 50
Busbars	

### Marking Tags

Special print only	DEK 5/6	0490360000*
Consecutive horizontal	DEK 5/6	0468660001
Consecutive vertical	DEK 5/6	0468760001

Note: Part numbers shown are for a single card of pre-printed tags numbered 1-50.

†Note: Resistive and inductive loads (0.05 - 16 A)

\*Please specify horizontal or vertical print when ordering.

Voltage Ratings

277 / 480 VAC (50/60 Hz); 65 VDC	Current Ratings
277 / 480 VAC (50/60 Hz); 65 VDC	0.1...32 A
250 / 415 VAC / 65 VDC	0.1...32 A

Rated current	Rated voltage	Rupture capacity (3 times)
0.05...0.8 A	250 / 415 VAC	400 A
6...32 A	250 / 415 VAC	800 A

Rated current	Rated voltage	Max. rupture capacity (3 times)
0.1...16 A	277 / 480 VAC	5000 A
20...32 A	277 / 480 VAC	2000 A
0.1...32 A	65 VDC	2000 A

Rated current	Rated voltage	Max. rupture capacity (3 times)
0.1...16 A	277 / 480 VAC	5000 A
20...32 A	277 / 480 VAC	2000 A
0.1...32 A	65 VDC	2000 A

Type	Part No.
BDC 50, 20 A maximum	9970290000
1 pole (CB2200)	9986510000
2 pole (CB2200)	9987360000

Type	Part No.
BDC 50, 20 A maximum	9970290000
1 pole (CB2200)	9986510000
2 pole (CB2200)	9987360000

Type	Part No.
BDC 50, 20 A maximum	9970290000
1 pole (CB2200)	9986510000
2 pole (CB2200)	9987360000

## Trip Curves—Thermal Magnetic Type Typical time/current characteristics at 23°C

CB2200 Series

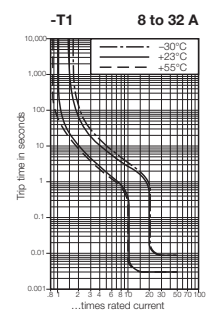
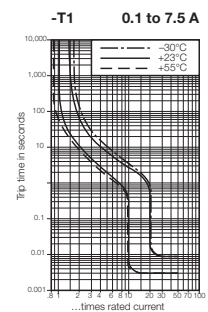
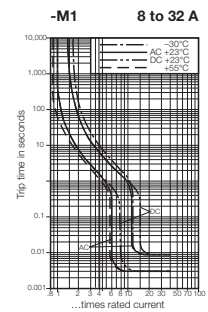
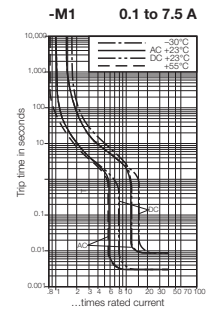
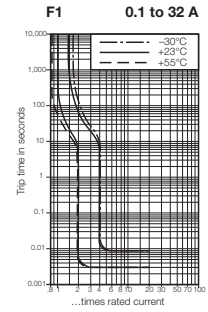



# CB9100 Series Supplemental Circuit Breakers

## CB9100 Series

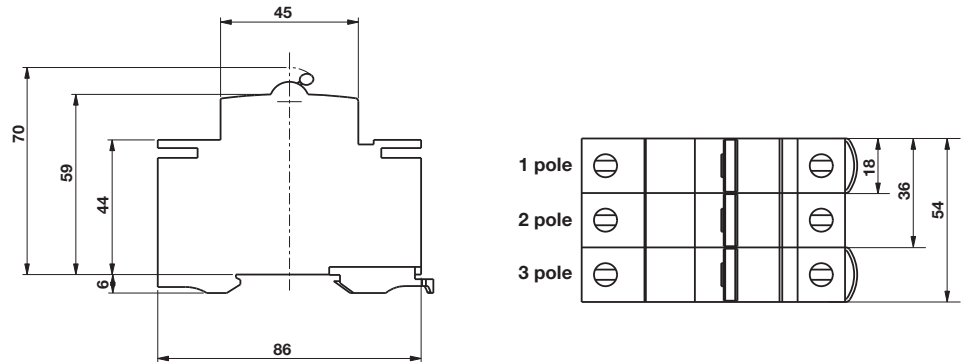

Dimensions in mm

### Internal Wiring Diagram

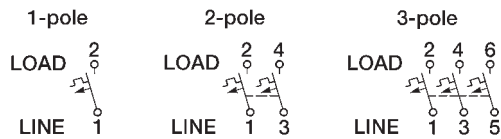

### Technical Data

Rated voltage & current

UL 1077

CSA C 22.2 No. 235

VDE

Creepage resistance

Insulation resistance

Interrupting capacity

(UL 1077/EN 609334 PC1) 1 pole

Mechanical/Electrical endurance

Shock

Torque

Vibration

Temperature range - operating

Weight

Strip length

Auxiliary contact rating

Wire size - #22...12 AWG

Wire size

### Accessories

Jumpers

Auxiliary contacts

SPDT

Security hardware

### Marking Tags

Adhesive label

277 V (1 pole) 480 V (2 and 3 pole) 50 VDC (1 pole) 110 VDC (2 pole)

277 V (1 pole) 480 V (2 and 3 pole) 50 VDC (1 pole) 110 VDC (2 pole)

PTI 250 to IEC 112

>100 MΩ at 500 VDC

Current ratings	Interrupting Rupture capacity (3X)	Voltage
0.5...63 A	10,000 A (UL)	277 VAC/50 VDC
0.5...32 A	2,000 A (UL)	277 / 480 AC
0.5...63 A	6,000 A (UL)	50 VDC (1) pole
0.5...50 A	6,000 A (UL)	110 VDC (2) poles

20,000/10,000

20 g (10 ms)

2 Nm

3 g (10 to 55 Hz)

-25°C...+55°C (-13°F to 131°F)

1 pole (130 g); 2 pole (280 g); 3 pole (430 g)

12 mm

Voltage Current

AC 220/240 5 A

AC 277 3 A

DC 24 V 4 A

DC 60 V 1 A

DC220 V 0.4 A

#18...2 AWG (line); #18...3 AWG (load)

### Auxiliary Contact Modules

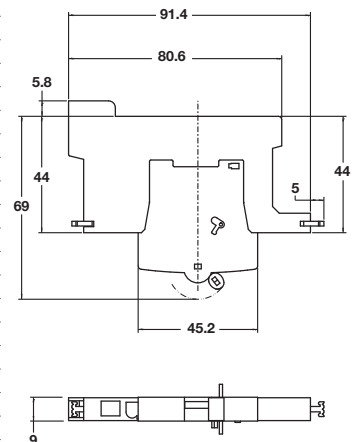

### Internal Auxiliary Wiring Diagram

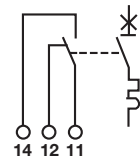

Type	Current Side/Middle	Part No.
3 pole bus, 10 x 1010 mm, buses (19) 3 phase groupings	80A/100A	9970330000
3 pole bus, 16 x 210 mm, buses (4) 3 phase groupings	120A/130A	9970340000
3 pole bus, 16 x 1010 mm, buses (19) 3 phase groupings	120A/130A	9970350000
1 pole bus, 12 x 210 mm, buses 12 breakers	80A/100A	9970360000
1 pole bus, 12 x 210 mm (insulated), buses 12 breakers	63A	9991990000
Bus bar clamp	130A	9970370000

Auxiliary contacts 9970300000

Lock out cover 9970380000

ETO 10/26, yellow (26 mm x 10 mm) 1686401687