

Features

Ultra-slim 1 Pole - 6 A relay

Printed circuit mount

- direct or via PCB socket

35 mm rail mount

- via screw, screwless or push-in terminal sockets

- 1 Pole changeover contacts or 1 Pole normally open contact
- Ultra slim, 5 mm, package
- Sensitive DC coil - 170 mW (Dual AC/DC coil drive possible using 93 series sockets)
- UL Listing (certain relay/socket combinations)
- Cadmium Free contact materials
- 8/8 mm clearance/creepage distance
- 6 kV (1.2/50 μ s) insulation, coil-contacts

34.51



- 5 mm wide
- Low coil power
- PCB or 93 series sockets

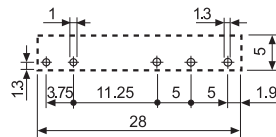
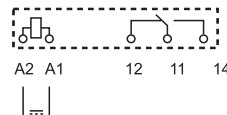

Copper side view

FOR UL RATINGS SEE:

"General technical information" page V

For outline drawing see page 5

Contact specification

Contact configuration		1 CO (SPDT)
Rated current/Maximum peak current	A	6/10
Rated voltage/Maximum switching voltage V AC		250/400
Rated load AC1	VA	1,500
Rated load AC15 (230 V AC)	VA	300
Single phase motor rating (230 V AC)	kW	0.185
Breaking capacity DC1: 30/110/220 V	A	6/0.2/0.12
Minimum switching load	mW (V/mA)	500 (12/10)
Standard contact material		AgNi

Coil specification

Nominal voltage (U_N)	V AC (50/60 Hz)	—
	V DC	5 - 12 - 24 - 48 - 60
Rated power AC/DC	VA (50 Hz)/W	—/0.17
Operating range	AC	—
	DC	$(0.7 \dots 1.5) U_N$
Holding voltage	AC/DC	—/0.4 U_N
Must drop-out voltage	AC/DC	—/0.05 U_N

Technical data

Mechanical life AC/DC	cycles	—/10 · 10 ⁶
Electrical life at rated load AC1	cycles	60 · 10 ³
Operate/release time	ms	5/3
Insulation between coil and contacts (1.2/50 μ s)	kV	6 (8 mm)
Dielectric strength between open contacts V AC		1,000
Ambient temperature range	°C	—40...+85
Environmental protection		RT II

Approvals (according to type)



Features

Ultra-slim - Solid State Relays

- Printed circuit mount**
- direct or via PCB socket
- 35 mm rail mount**
- via screw, screwless or push-in terminal sockets

- Single circuit output switching options
 - 2 A 24 V DC
 - 0.1 A 48 V DC
 - 2 A 240 V AC
- Silent, high speed switching with long electrical life
- Ultra slim, 5 mm, package
- Sensitive DC Input circuits (Dual AC/DC input drive possible using 93 series sockets)
- UL Listing (certain relay/socket combinations)
- Wash tight: RT III
- 2,500 V insulation, input-output

34.81-9024



- 2 A, 24 V DC output switching
- PCB or 93 series sockets

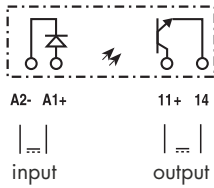

Copper side view

34.81-7048



- 0.1 A, 48 V DC output switching
- PCB or 93 series sockets

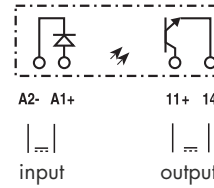

Copper side view

34.81-8240



- 2 A, 240 V AC output switching
- Zero crossing switching
- PCB or 93 series sockets

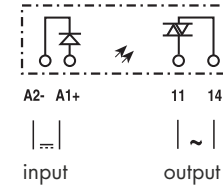

Copper side view

For outline drawing see page 5

Output circuit

Contact configuration		1 NO (SPST-NO)				1 NO (SPST-NO)		1 NO (SPST-NO)			
Rated current/Maximum peak current (10 ms) A		2/20				0.1/0.5		2/40			
Rated voltage/Maximum blocking voltage V		(24/33)DC				(48/60)DC		(240/-)AC			
Switching voltage range V		(1.5...24)DC				(1.5...48)DC		(12...275)AC			
Repetitive peak off-state voltage V _{pk}		—				—		600			
Minimum switching current mA		1				0.05		22			
Max. "OFF-state" leakage current mA		0.001				0.001		1.5			
Max. "ON-state" voltage drop V		0.12				1		1.6			

Input circuit

Nominal voltage V DC		5	12	24	60	24	60	5	12	24	60
Rated power AC/DC W		0.035	0.087	0.17	0.18	0.17	0.18	0.060	0.087	0.17	0.18
Operating range V DC		3.5...12	8...17	16...30	35...72	16...30	35...72	3.5...10	8...17	16...30	35...72
Control current mA		7	7.2	7	3	7	3	12	7.2	7	3
Release voltage V DC		1	4	10	20	10	20	1	4	10	20
Impedance Ω		715	1,940	3,200	21,300	3,200	21,300	416	1,940	3,200	21,300

Technical data

Operate/release time ms		0.1/0.6*				0.04/0.6*		12/12*			
Dielectric strength between input/output V		2,500				2,500		2,500			
Ambient temperature range °C		-20...+60				-20...+60		-20...+60			
Environmental protection		RT III				RT III		RT III			

Approvals (according to type)



* Note: all technical data relates to using the relay directly on PCB or PCB socket type 93.11. If the relay is used with 35 mm rail socket type 93.51, refer to the technical data of 38 Series; if used with types 93.60, 93.61, 93.62, 93.63, 93.64, 93.65, 93.66, 93.67, 93.68 and 93.69, refer to the technical data of the MasterINTERFACE 39 Series.

Ordering information

Electromechanical relay (EMR)

Example: 34 series slim electromechanical relay, 1 CO (SPDT) 6 A contacts, 24 V sensitive DC coil.

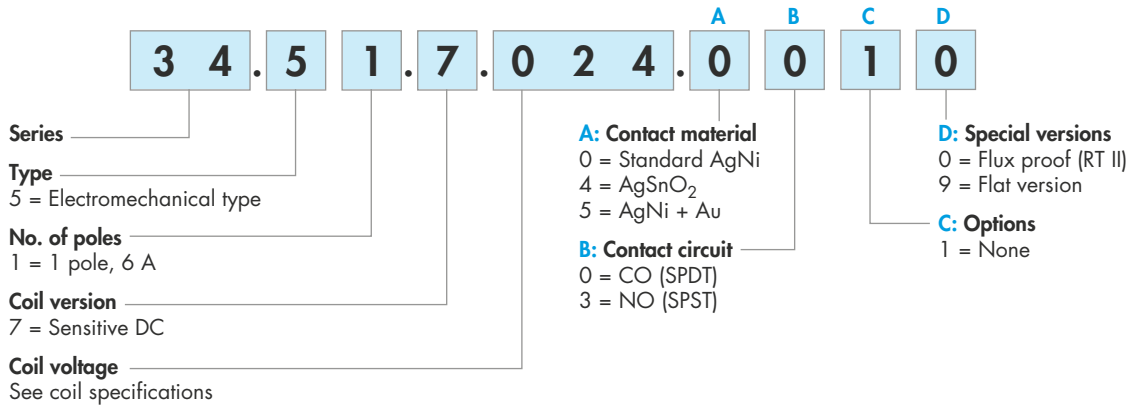

Selecting features and options: only combinations in the same row are possible.
Preferred selections for best availability are shown in **bold**.

Type	Coil version	A	B	C	D
34.51	sens. DC	0 - 4 - 5	0 - 3	1	0
34.51	sens. DC	0 - 4 - 5	0	1	9

Solid state relay (SSR)

Example: 34 series SSR relay, 2 A output, 24 V DC supply.

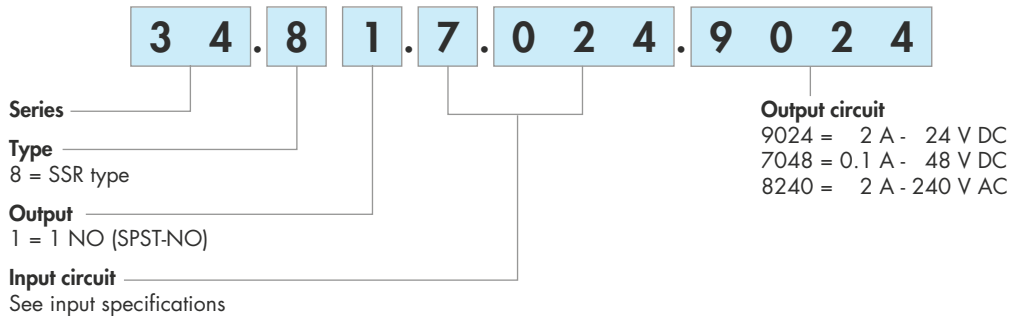

Flat pack version

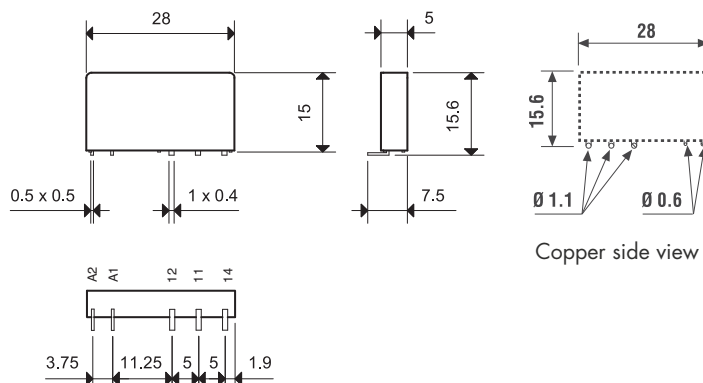

Option = 34.51.7xxx.x019

Environmental protection RT I

Electromechanical relay

Technical data

A

Insulation according to EN 61810-1

Nominal voltage of supply system	V AC	230/400	
Rated insulation voltage	V AC	250	400
Pollution degree		3	2

Insulation between coil and contact set

Type of insulation	Reinforced		
Overvoltage category	III		
Rated impulse voltage	kV (1.2/50 μs)	6	
Dielectric strength	V AC	4,000	

Insulation between open contacts

Type of disconnection	Micro-disconnection		
Dielectric strength	V AC/kV (1.2/50 μs)	1,000/1.5	

Conducted disturbance immunity

Burst (5...50)ns, 5 kHz, on A1 - A2	EN 61000-4-4	level 4 (4 kV)
Surge (1.2/50 μs) on A1 - A2 (differential mode)	EN 61000-4-5	level 3 (2 kV)

Other data

Bounce time: NO/NC	ms	1/6	
Vibration resistance (5...55)Hz: NO/NC	g	10/5	
Shock resistance	g	20/14	
Power lost to the environment	without contact current	W	0.2
	with rated current	W	0.5
Recommended distance between relays mounted on PCB	mm	≥ 5	

Contact specification

F 34 - Electrical life (AC) v contact current

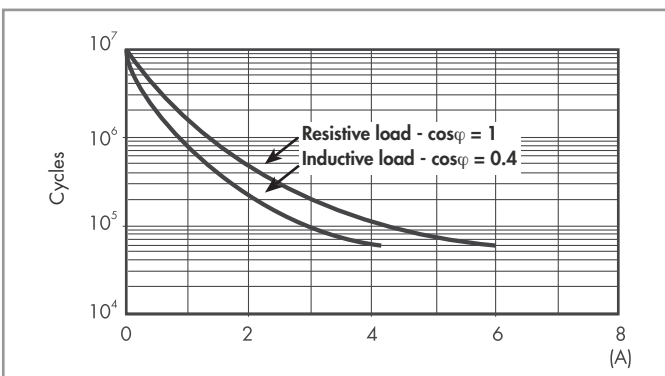

H 34 - Maximum DC1 breaking capacity

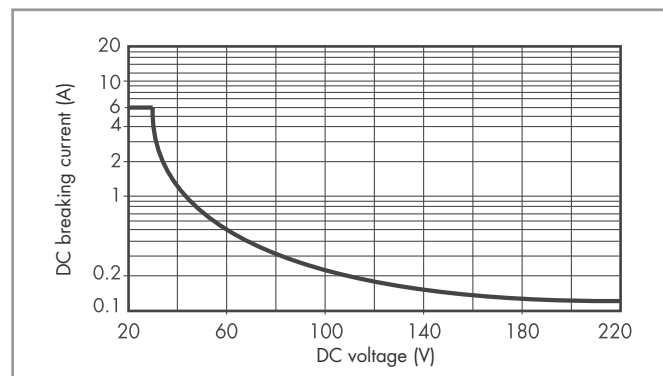

- When switching a resistive load (DC1) having voltage and current values under the curve, an electrical life of $\geq 60 \cdot 10^3$ can be expected.
- In the case of DC13 loads, the connection of a diode in parallel with the load will permit a similar electrical life as for a DC1 load. Note: the release time for the load will be increased.

Coil specifications

DC coil data

Nominal voltage U_N V	Coil code	Operating range		Resistance R Ω	Rated coil consumption I at U_N mA
		U_{min} V	U_{max} V		
5	7.005	3.5	7.5	130	38.4
12	7.012	8.4	18	840	14.2
24	7.024	16.8	36	3,350	7.1
48	7.048	33.6	72	12,300	3.9
60	7.060	42	90	19,700	3

R 34 - DC coil operating range v ambient temperature

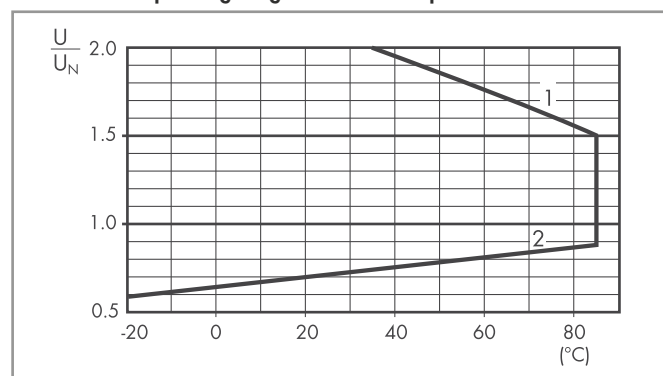

- 1 - Max. permitted coil voltage.
- 2 - Min. pick-up voltage with coil at ambient temperature.

Solid state relay

Technical data

EMC specifications		Reference standard	
Electrostatic discharge	contact discharge	EN 61000-4-2	4 kV
	air discharge	EN 61000-4-2	8 kV
Fast transients on supply terminals (burst 5/50 ns, 5 kHz)		EN 61000-4-4	2 kV
Voltage pulses on supply terminals (surge 1.2/50 µs)	common mode	EN 61000-4-5	0.5 kV
	differential mode	EN 61000-4-5	0.5 kV
Other data			
Power lost to the environment	without output current	W	0.17
	with rated current	W	0.4

Input specification

Input data - DC types

Nominal voltage U_N V	Input code	Operating range		Release voltage V	Impedance Ω	Control current I at U_N mA
		U_{min} V	U_{max} V			
5	7.005	3.5	12 (10*)	1	715 (416*)	7 (12*)
12	7.012	8	17	4	1,940	7.2
24	7.024	16	30	10	3,200	7
60	7.060	35	72	20	21,300	3

* AC Output version.

Output specification

L 34 - Output current v ambient temperature
SSR - 2 A DC & AC output types

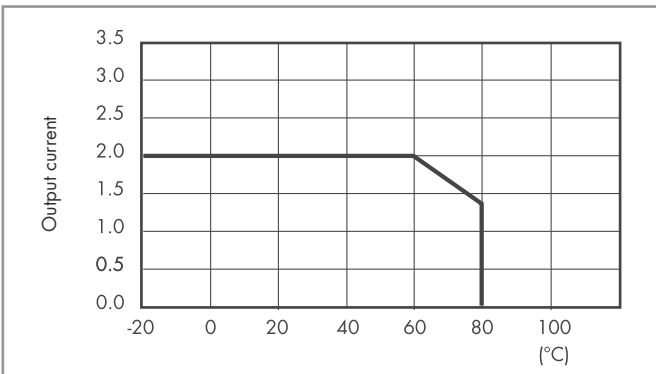

L 34 - Output current v ambient temperature
SSR - 0.1 A DC output types

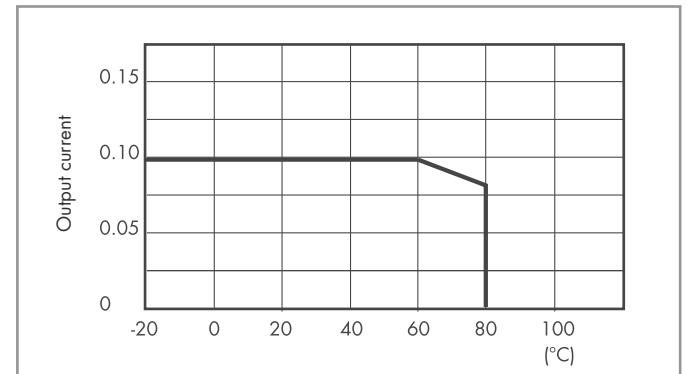

Outline drawings

Type 34.51

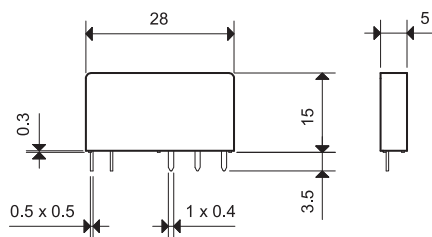

Type 34.81

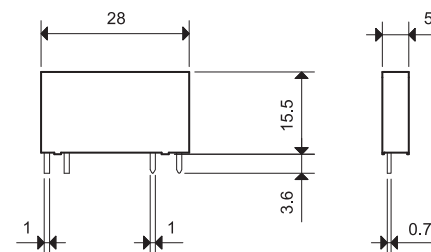



A



93.61



Screw terminal socket 35mm rail mounting (EN 60715) NEW

Common features

- Space saving 6.2 mm wide
- Connections for 16-way jumper link
- Integral coil indication and protection circuit
- Secure retention and easy ejection by plastic clip
- Dual screw head (blade+cross) terminals

For technical data and supply versions, refer to the *MasterINTERFACE 39 Series* – “Relay interface module”



93.62



Electromechanical Relay - EMR

Supply voltage	Relay type	Socket type (reference with the 39 Series)				
		MasterBASIC (39.11.....)	MasterPLUS (39.31.....)	MasterINPUT (39.41.....)	MasterOUTPUT (39.21.....)	MasterTIMER (39.81.....)
6 V AC/DC	34.51.7.005.xx10	93.61.7.024	93.63.7.024	93.64.7.024	93.62.7.024	—
12 V AC/DC	34.51.7.012.xx10	93.61.7.024	93.63.7.024	93.64.7.024	93.62.7.024	93.68.0.024
24 V AC/DC	34.51.7.024.xx10	93.61.7.024	93.63.7.024	93.64.7.024	93.62.7.024	93.68.0.024
60 V AC/DC	34.51.7.060.xx10	—	93.63.7.060	—	—	—
(110...125)V AC/DC*	34.51.7.060.xx10	—	93.63.3.125	—	—	—
(220...240)V AC*	34.51.7.060.xx10	—	93.63.3.230	—	—	—
(110...125)V AC/DC	34.51.7.060.xx10	93.61.0.125	93.63.0.125	93.64.0.125	93.62.0.125	—
(24...240)V AC/DC	34.51.7.024.xx10	—	93.63.0.240	—	—	—
(220...240)V AC	34.51.7.060.xx10	93.61.8.230	93.63.8.230	93.64.8.230	93.62.8.230	—
(110...125) V DC	34.51.7.060.xx10	—	93.63.7.125	—	—	—
220 V DC	34.51.7.060.xx10	—	93.63.7.220	—	—	—

* Leakage current suppression



93.63



93.64



Solid State Relay - SSR

Supply voltage	Relay type	Socket type (reference with the 39 Series)				
		MasterBASIC (39.10.....)	MasterPLUS (39.30.....)	MasterINPUT (39.40.....)	MasterOUTPUT (39.20.....)	MasterTIMER (39.80.....)
12 V AC/DC	34.81.7.012.xxxx	—	—	—	—	93.68.0.024
24 V AC/DC	34.81.7.024.xxxx	—	93.63.0.024	93.64.0.024	—	93.68.0.024
(110...125)V AC/DC*	34.81.7.060.xxxx	—	93.63.3.125	—	—	—
(220...240)V AC*	34.81.7.060.xxxx	—	93.63.3.230	—	—	—
(110...125)V AC/DC	34.81.7.060.xxxx	93.61.0.125	93.63.0.125	93.64.0.125	93.62.0.125	—
(24...240)V AC/DC	34.81.7.024.xxxx	—	93.63.0.240	—	—	—
(220...240)V AC	34.81.7.060.xxxx	93.61.8.230	93.63.8.230	93.64.8.230	93.62.8.230	—
6 V DC	34.81.7.005.xxxx	93.61.7.024	93.63.7.024	93.64.7.024	93.62.7.024	—
12 V DC	34.81.7.012.xxxx	93.61.7.024	93.63.7.024	93.64.7.024	93.62.7.024	—
24 V DC	34.81.7.024.xxxx	93.61.7.024	93.63.7.024	93.64.7.024	93.62.7.024	—
60 V DC	34.81.7.060.xxxx	—	93.63.7.060	—	—	—
(110...125) V DC	34.81.7.060.xxxx	—	93.63.7.125	—	—	—
220 V DC	34.81.7.060.xxxx	—	93.63.7.220	—	—	—

* Leakage current suppression

Accessories

16-way jumper link	093.16 (blue), 093.16.0 (black), 093.16.1 (red)
Dual-purpose plastic separator	093.60
Sheet of marker tags	060.72

Technical data

Rated values	6 A – 250 V
Dielectric strength	6 kV (1.2/50 µs) between coil and contacts
Protection category	IP20
Ambient temperature	°C –40...+70
Screw torque	Nm 0.5
Wire strip length	mm 10
Max wire size	Solid wire and stranded wire
	mm ² 1 x (0.2...2.5) / 2 x 1.5
	AWG 1 x (24...14) / 2 x 16

Approvals
(according to type):





93.60

Push-In terminal socket 35mm rail mounting (EN 60715) NEW

Common features

- Space saving 6.2 mm wide
- Connections for 16-way jumper link
- Terminal doubler 093.62
- Integral coil indication and protection circuit
- Secure retention and easy ejection by plastic clip

For technical data and supply versions, refer to the *MasterINTERFACE 39 Series* – “Relay interface module”

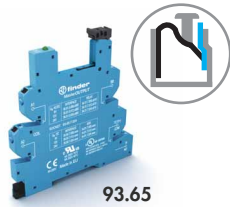

93.65

Electromechanical Relay - EMR

Supply voltage	Relay type	Socket type (reference with the 39 Series)				
		MasterBASIC (39.01.....)	MasterPLUS (39.61.....)	MasterINPUT (39.71.....)	MasterOUTPUT (39.51.....)	MasterTIMER (39.91.....)
6 V AC/DC	34.51.7.005.xx10	93.60.7.024	93.66.7.024	93.67.7.024	93.65.7.024	—
12 V AC/DC	34.51.7.012.xx10	93.60.7.024	93.66.7.024	93.67.7.024	93.65.7.024	93.69.0.024
24 V AC/DC	34.51.7.024.xx10	93.60.7.024	93.66.7.024	93.67.7.024	93.65.7.024	93.69.0.024
60 V AC/DC	34.51.7.060.xx10	—	93.66.7.060	—	—	—
(110...125)V AC/DC*	34.51.7.060.xx10	—	93.66.3.125	—	—	—
(220...240)V AC*	34.51.7.060.xx10	—	93.66.3.230	—	—	—
(110...125)V AC/DC	34.51.7.060.xx10	93.60.0.125	93.66.0.125	93.67.0.125	93.65.0.125	—
(24...240)V AC/DC	34.51.7.024.xx10	—	93.66.0.240	—	—	—
(220...240)V AC	34.51.7.060.xx10	93.60.8.230	93.66.8.230	93.67.8.230	93.65.8.230	—
(110...125) V DC	34.51.7.060.xx10	—	93.66.7.125	—	—	—
220 V DC	34.51.7.060.xx10	—	93.66.7.220	—	—	—

* Leakage current suppression



93.66

Solid State Relay - SSR

Supply voltage	Relay type	Socket type (reference with the 39 Series)				
		MasterBASIC (39.00.....)	MasterPLUS (39.60.....)	MasterINPUT (39.70.....)	MasterOUTPUT (39.50.....)	MasterTIMER (39.90.....)
12 V AC/DC	34.81.7.012.xxxx	—	—	—	—	93.69.0.024
24 V AC/DC	34.81.7.024.xxxx	—	93.66.0.024	93.67.0.024	—	93.69.0.024
(110...125)V AC/DC*	34.81.7.060.xxxx	—	93.66.3.125	—	—	—
(220...240)V AC*	34.81.7.060.xxxx	—	93.66.3.230	—	—	—
(110...125)V AC/DC	34.81.7.060.xxxx	93.60.0.125	93.66.0.125	93.67.0.125	93.65.0.125	—
(24...240)V AC/DC	34.81.7.024.xxxx	—	93.66.0.240	—	—	—
(220...240)V AC	34.81.7.060.xxxx	93.60.8.230	93.66.8.230	93.67.8.230	93.65.8.230	—
6 V DC	34.81.7.005.xxxx	93.60.7.024	93.66.7.024	93.67.7.024	93.65.7.024	—
12 V DC	34.81.7.012.xxxx	93.60.7.024	93.66.7.024	93.67.7.024	93.65.7.024	—
24 V DC	34.81.7.024.xxxx	93.60.7.024	93.66.7.024	93.67.7.024	93.65.7.024	—
60 V DC	34.81.7.060.xxxx	—	93.66.7.060	—	—	—
(110...125) V DC	34.81.7.060.xxxx	—	93.66.7.125	—	—	—
220 V DC	34.81.7.060.xxxx	—	93.66.7.220	—	—	—

* Leakage current suppression

Accessories

16-way jumper link	093.16 (blue), 093.16.0 (black), 093.16.1 (red)
Dual-purpose plastic separator	093.60
Terminal doubler	093.62
Sheet of marker tags	060.72

Technical data

Rated values	6 A – 250 V
Dielectric strength	6 kV (1.2/50 µs) between coil and contacts
Protection category	IP20
Ambient temperature	°C –40...+70
Wire strip length	mm 8
Max wire size	Solid wire and stranded wire
	mm ² 1 x (0.2...2.5)
	AWG 1 x (24...14)

Approvals
(according to type):



A

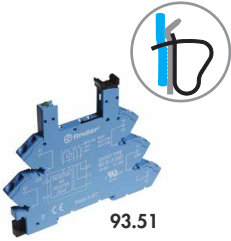

93.51

Approvals
(according to type):



UL US Certain relay/socket combinations



Screw less terminal socket 35mm rail mounting (EN 60715)

Common features

- Space saving 6.2 mm wide
- Connections for 20-way jumper link
- Integral coil indication and protection circuit
- Secure retention and easy ejection by plastic clip

For technical data and supply versions, refer to the **38 Series** – “Relay interface module”

Electromechanical Relay - EMR and Solid State Relay - SSR

Supply voltage	Relay type (reference with the 38 Series)		Socket type
	Electromechanical relay - EMR (38.61.....)	Solid State Relay - SSR (38.81.....)	
12 V AC/DC	34.51.7.012.xx10	—	93.51.0.024
24 V AC/DC	34.51.7.024.xx10	—	93.51.0.024
(110...125)V AC/DC	34.51.7.060.xx10	34.81.7.060.xxxx	93.51.0.125
(220...240)V AC/DC	34.51.7.060.xx10	34.81.7.060.xxxx	93.51.0.240
(110...125)V AC/DC *	34.51.7.060.xx10	34.81.7.060.xxxx	93.51.3.125
(220...240)V AC *	34.51.7.060.xx10	34.81.7.060.xxxx	93.51.3.240
(220...240)V AC	34.51.7.060.xx10	34.81.7.060.xxxx	93.51.8.240
12 V DC	34.51.7.012.xx10	34.81.7.012.xxxx	93.51.7.024
24 V DC	34.51.7.024.xx10	34.81.7.024.xxxx	93.51.7.024
60 V DC	34.51.7.060.xx10	34.81.7.060.xxxx	93.51.7.060

* Leakage current suppression

Accessories

20-way jumper link	093.20
Plastic separator	093.01
Sheet of marker tags	093.64

Technical data

Rated values	6 A – 250 V	
Dielectric strength	6 kV (1.2/50 μs) between coil and contacts	
Protection category	IP20	
Ambient temperature (U _N ≤ 60 V / > 60 V)	°C	-40...+70 / -40...+55
Wire strip length	mm	10
Max wire size	Solid wire and stranded wire	
	mm ²	1 x 2.5 / 2 x 1.5
	AWG	1 x 14 / 2 x 16



93.11

Approvals
(according to type):



PCB socket with retaining and release clip	93.11 (blue)
For relay type	34.51, 34.81
Technical data	
Rated values	6 A - 250 V
Dielectric strength	≥ 6 kV (1.2/50 μs) between coil and contacts
Protection category	IP 20
Ambient temperature	°C -40...+70

Retaining and release clip use:

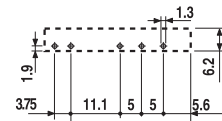
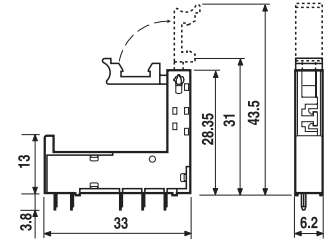
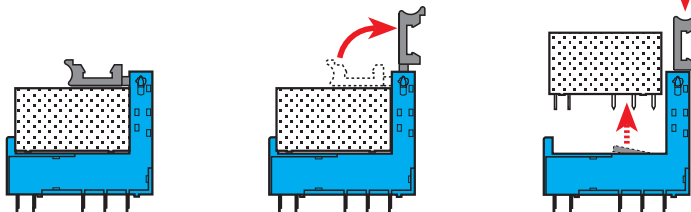

Copper side view

