



DESCRIPTION

The 1" x 0.1" grid relay series is a general purpose series that is pin-for-pin compatible with most competitor relays. Some configurations of this relay series are capable of switching up to 1000 V and up to a maximum of 50 Watts. The series includes Form-A, Form-B and Form-C models, some of which have up to 6 poles.

FEATURES

- Standard nominal voltages include 5, 12 and 24 volts
- Electromagnetic shield
- Multi-pole configurations
- 1.0" x 0.15" pin spacing available
- FCC Part 68 compatible

APPLICATIONS

- Telecom
- Instrumentation
- General purpose electronics
- Industrial
- Process control

APPROVALS

- UL Recognized (MRB)

RATINGS (@ 25° C)

Parameter	Min	Typ	Max	Unit
Switching Voltage				
MRB			200	Volts
922A			125	Volts
Switching Current				
MRB			0.50	Amps
922A			0.25	Amps
Carry Current				
MRB			1.5	Amps
922A			0.4	Amps
Switching Frequency				
MRB/922A			500	Hz
Contact Resistance				
MRB/922A			200	mΩ

(See detailed specifications for more information.)

MECHANICAL DIMENSIONS

DIMENSIONS
mm
(inches)

1.0 x .15 1A

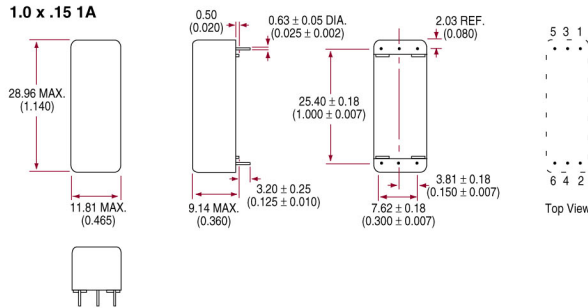

1.0 x .15 1A

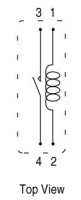

1.0 x .15 2A

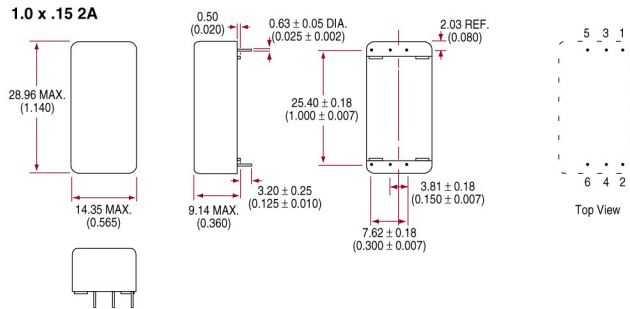

1.0 x .15 2A



1.0 x .15 3A

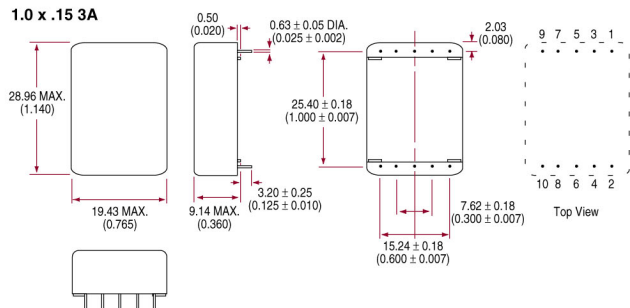

1.0 x .15 3A

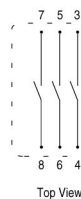

1.0 x .15 4A

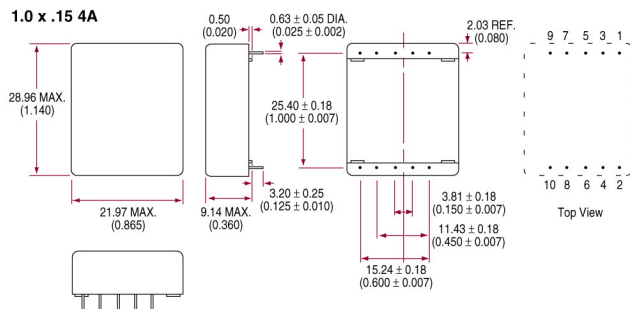

1.0 x .15 4A



1" x 0.1" GRID RELAYS

MRB ■ 922A

MECHANICAL DIMENSIONS

DIMENSIONS
mm
(inches)

1.0 X 0.1 4A

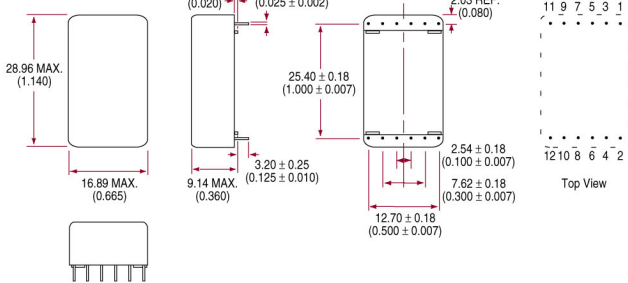

1.0 X 0.1 4A

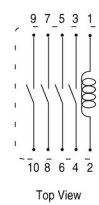

1.0 x 0.1 5A/2N/3C

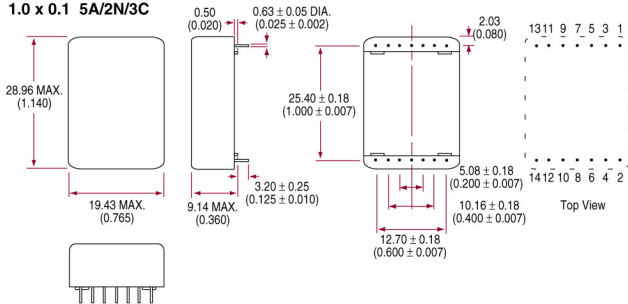

1.0 x 0.1 5A

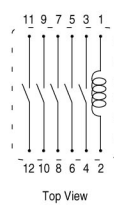

1.0 x 0.1 2N

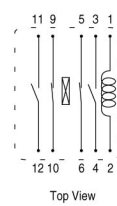

1.0 x 0.1 3C

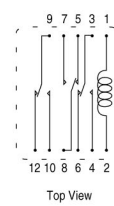

1.0 x 0.1 6A/4C

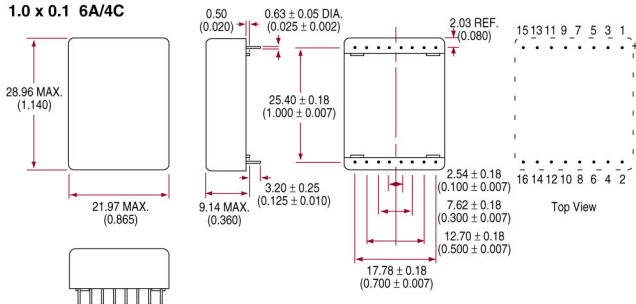

1.0 x 0.1 6A

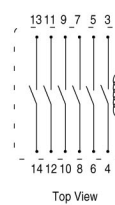

1.0 x 0.1 4C

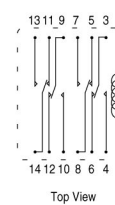

1" x 0.1" GRID RELAYS

MRB ■ 922A

MECHANICAL DIMENSIONS

DIMENSIONS
mm
(inches)

1.0 x 0.1 1A

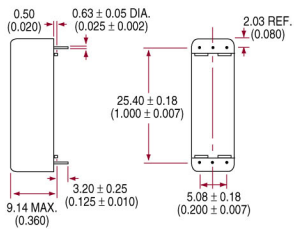
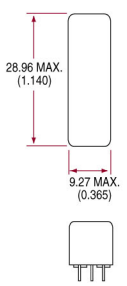

1.0 x 0.1 1A



1.0 x 0.1 2A/1C/1B/1L

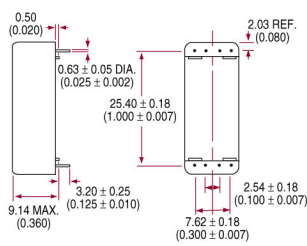
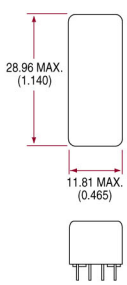

1.0 x 0.1 2A



1.0 x 0.1 1B

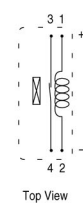

1.0 x 0.1 1C



1.0 x 0.1 1L

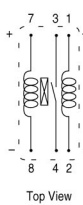

1.0 x 0.1 3A/2B/1N/2L/2C

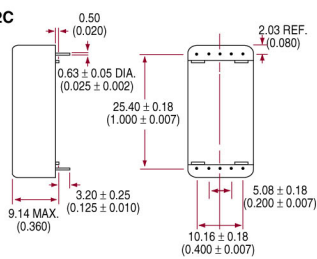
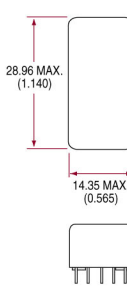

1.0 x 0.1 3A



1.0 x 0.1 2B

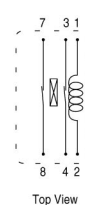

1.0 x 0.1 2C

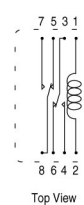

1.0 x 0.1 1N

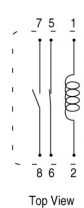

1.0 x 0.1 2L

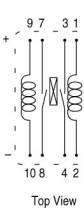



1" x 0.1" GRID RELAYS

MRB ■ 922A

COIL SPECIFICATIONS

Units	Coil Voltage			Coil Resistance			Operate Voltage			Release Voltage		
	Volts			Ω			Volts			Volts		
Conditions				±10% (25°C)			Must operate by (25°C)			Must release by (25°C)		
Part #	Min	Typ	Max	Min	Typ	Max	Min	Typ	Max	Min	Typ	Max
922A05C2C		5		90	100	110			3.75	0.4		
922A06C2C		6		131	145	160			4.5	0.5		
922A12C2C		12		567	630	693			9	1		
922A24C2C		24		2268	2520	2772			18	2		
922A05C3C		5		68	75	83			3.75	0.4		
922A06C3C		6		81	90	99			4.5	0.5		
922A12C3C		12		324	360	396			9	1		
922A24C3C		24		1188	1320	1452			18	2		
922A05C4C		5		45	50	55			3.75	0.4		
922A06C4C		6		63	70	77			4.5	0.5		
922A12C4C		12		252	280	308			9	1		
922A24C4C		24		1008	1120	1232			18	2		
MRB1A1505		5		203	225	248			3.75	0.15		
MRB1A1506		6		306	340	374			4.5	0.15		
MRB1A1512		12		1260	1400	1540			9	0.7		
MRB1A1524		24		3906	4340	4774			18	1.4		
MRB2A1505		5		72	80	88			3.75	0.15		
MRB2A1506		6		117	130	143			4.5	0.15		
MRB2A1512		12		513	570	627			9	0.7		
MRB2A1524		24		1395	1550	1705			18	1.4		
MRB3A1505		5		54	60	66			3.75	0.15		
MRB3A1506		6		90	100	110			4.5	0.15		
MRB3A1512		12		405	450	495			9	0.7		
MRB3A1524		24		981	1090	1199			18	1.4		
MRB4A1505		5		29	32	35			3.75	0.15		
MRB4A1506		6		45	50	55			4.5	0.15		
MRB4A1512		12		189	210	231			9	0.7		
MRB4A1524		24		810	900	990			18	1.4		



1" x 0.1" GRID RELAYS

MRB ■ 922A

COIL SPECIFICATIONS

Part #	Coil Voltage			Coil Resistance			Operate Voltage			Release Voltage			Nominal Input Power		
	Volts			Ω			Volts			Volts			mW		
	Min	Typ	Max	Min	Typ	Max	Min	Typ	Max	Min	Typ	Max	Min	Typ	Max
MRB1A05	5	13	203	225	248	3.75	0.15								111
MRB1A06	6	16	306	340	374	4.5	0.15								106
MRB1A12	12	32	1260	1400	1540	9	0.7								103
MRB1A24	24	57	3906	4340	4774	18	1.4								133
MRB2A05	5	9	95	105	116	3.75	0.15								238
MRB2A06	6	12	162	180	198	4.5	0.15								200
MRB2A12	12	24	657	730	803	9	0.7								197
MRB2A24	24	45	2250	2500	2750	18	1.4								230
MRB3A05	5	8	74	82	90	3.75	0.15								305
MRB3A06	6	11	117	130	143	4.5	0.15								277
MRB3A12	12	22	513	570	627	9	0.7								253
MRB3A24	24	36	1386	1540	1694	18	1.4								374
MRB4A05	5	8	54	60	66	3.75	0.15								417
MRB4A06	6	10	90	100	110	4.5	.15								360
MRB4A12	12	16	248	275	303	9	0.7								524
MRB4A24	24	32	981	1090	1199	18	1.4								528
MRB5A05	5	7	41	45	50	3.75	0.15								
MRB5A06	6	8	63	70	77	4.5	0.15								514
MRB5A12	12	17	252	280	308	9	0.7								514
MRB5A24	24	30	828	920	1012	18	1.4								626
MRB6A05	5	6	29	32	35	3.75	0.15								781
MRB6A06	6	7	45	50	55	4.5	0.15								720
MRB6A12	12	15	189	210	231	9	0.7								686
MRB6A24	24	31	810	900	990	18	1.4								640
MRB1B05	5	6	270	300	330	3.75	0.4								83
MRB1B12	12	15	1116	1240	1364	9	1								116
MRB1B24	24	30	5220	5800	6380	18	2								99
MRB2B05	5	6	74	82	90	3.75	0.4								305
MRB2B12	12	15	513	570	627	9	1								253
MRB2B24	24	30	2097	2330	2563	18	2								247
MRB1N05	5		45	50	55	3.75	0.4								500
MRB1N06	6		74	82	90	4.5	0.5								440
MRB1N12	12		207	230	253	9	1								626
MRB1N24	24		810	900	990	18	2								640
MRB2N05	5		25	28	31	3.75	0.4								893
MRB2N06	6		41	45	50	4.5	0.5								800
MRB2N12	12		167	185	204	9	1								778
MRB2N24	24		720	800	880	18	2								720
MRB1L01	5		81	90	99	3.75	Latch								N/A
MRB2L02	5		99	110	121	3.75	Latch								N/A
922A05C1C	5		180	200	220	3.75	0.4								125
922A06C1C	6		243	270	297	4.5	0.5								133
922A12C1C	12		972	1080	1188	9	1								133
922A24C1C	24		3888	4320	4752	18	2								133



1" x 0.1" GRID RELAYS

MRB ■ 922A

All parameters are at 25°C unless otherwise stated.
Operate voltage, release voltage, and coil resistance will change approximately 0.4%/°C as ambient temperature varies.

SPECIFICATIONS

MRB

922A

PARAMETER	CONDITIONS	SYMBOL	MIN	TYP	MAX	MIN	TYP	MAX	UNITS
Contact Ratings									
Switching Voltage	Max DC/PeakAC Resistive	V _L	-	-	200	-	-	125	Volts
Switching Current	Max DC/PeakAC Resistive	I _L	-	-	0.5	-	-	0.25	Amps
Carry Current	Max DC/PeakAC Resistive	I _c	-	-	1.5	-	-	0.4	Amps
Contact Rating	Max DC/PeakAC Resistive	-	-	-	10	-	-	3	Watts
Life Expectancy	Signal Level 1.0V 10mA	-	300	500	-	-	100	-	x10 ⁶ Ops
	Rated Loads ⁽¹⁾	-	-	-	-	-	-	-	x10 ⁶ Ops
Static Contact Resistance	50mV, 10mA	CR	-	-	200	-	-	200	mΩ
Dynamic Contact Resistance	.5V, 50mA at 100Hz, 1.5 msec	DCR	-	-	200	-	-	200	mΩ
Contact Material		-	-	Rh	-	-	Ru	-	-
Hg Content		-	-	N/A	-	-	N/A	-	mgrams
Relay Specifications									
Insulation Resistance	Between all isolated pins at 100V, 25°C, 40% RH	IR	10 ¹⁰	-	-	10 ⁸	-	-	Ω
Capacitance	Across Open Contacts	-	-	-	1	-	-	-	pF
	Open Contact to Coil	-	-	-	2	-	-	-	pF
Dielectric Strength	Between Contacts	-	250	-	-	-	-	-	VDC/PeakAC
	Contacts to Coil	I/O	1400	-	-	-	-	-	VDC/PeakAC
Operate Time including bounce	At Nominal Coil Voltage 10Hz Square Wave	T _{OP}	-	1	2	-	1.5	-	ms
Release Time	Zener-Diode Suppression	T _{REL}	-	0.50	2	-	2	-	ms
Environmental Ratings									
Storage Temperature		T _A	-40	-	+105	-40	-	+105	°C
Operating Temperature		T _O	-20	-	+85	-38	-	+85	°C
Soldering Temperature	Applied to pins, 5 sec. max.	-	-	-	+260	-	-	+260	°C
Vibration Resistance (Survival)	10Hz - 500Hz	G	-	-	10	-	-	10	Gs
Shock Resistance (Survival)	11±1ms, 1/2 Sine Wave	S	-	-	20	-	-	30	Gs
Weight		-	-	5.8	-	-	-	5.1	grams

⁽¹⁾ For further information, consult factory



1" x 0.1" GRID RELAYS

MRB ■ 922A

ORDERING INFORMATION

A complete part number is represented by the digits below.

