

# MICRO SWITCH™ 914CE Series

## Compact Limit Switch

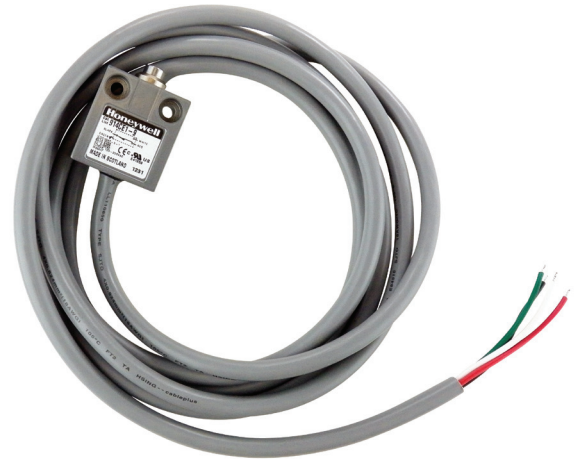

### DESCRIPTION

All MICRO SWITCH™ 914CE series compact enclosed switches incorporate fluorocarbon diaphragm sealing to provide reliable protection, meeting NEMA 1, 2, 3, 3R, 4, 6, 6P, and 13 as well as IP66, IP67, and IP68 requirements. Versions with boot seal also meet NEMA 12 requirements (dust, falling dirt, liquid media with solid contaminants). The cable or connector and basic switch terminals are encapsulated in an epoxy compound, offering superior resistance in harsh environments. For low temperature applications (down to -40 °C, -40 °F), CE switches can be supplied with low temperature seals and lubricant.

### FEATURES

- Compact construction
- Pre-wired or connector versions
- Die-cast zinc housing
- Wide selection of actuators
- Gang mounting capability
- Cable length variations
- Side and bottom exit cable/connector
- Simple two-screw mounting
- Low temperature variants
- Fluorocarbon sealing (standard)
- Approvals: UL, CSA, CE

The CE switches are a rugged and versatile switch which can be applied indoors in harsh factory floor applications, as well as on outdoor equipment in extreme temperatures. A full range of actuators are available, including plain plungers, roller plungers, side rotary, multi-directional wire, and manually operated. The switches are also available with the industry standard, M12 miniature 4-pin connector. MICRO SWITCH™ 914CE products meet UL and CSA standards, as well as European CE requirements.

### POTENTIAL APPLICATIONS

- Processing equipment
- Textile machinery
- Machine tools
- Robotics
- Packaging equipment
- Farm machinery
- Commercial laundry equipment
- Printing Trade machinery
- Vehicles

# MICRO SWITCH™ 914CE Series

## SPECIFICATIONS

Characteristic	Parameter
Description	Compact enclosed limit switch
Actuators	<ul style="list-style-type: none"> <li>• Top pin plunger</li> <li>• Top pin plunger (panel mounted)</li> <li>• Adjustable plunger</li> <li>• Cross roller plunger</li> <li>• Parallel top roller plunger</li> <li>• Parallel and panel-mounted top roller plunger</li> <li>• Top pin plunger with boot seal</li> <li>• Ball bearing plunger</li> <li>• Manually operated</li> <li>• Wobble</li> <li>• Parallel &amp; boot sealed top roller plunger</li> </ul>
Terminations	<ul style="list-style-type: none"> <li>• SJTO 4 x 0,75 mm<sup>2</sup> (18 AWG) cable</li> <li>• Connector (dc), 4-pin male, M12 thread (-Q)</li> <li>• Connector (ac), 4-pin male, 1/2 in x 20 thread (-Q1)</li> </ul>
Switching options	SPDT, snap action contacts (1NC/1NO)
Sealing	IP66, IP67, IP68 (depending upon model) NEMA 1, 2, 3, 3R, 4, 6, 6P, 12 (boot seal), 13
Operating temperature (914CE)	0 °C to 105 °C [32 °F to 221 °F]
Mechanical life	10 million
Thermal current	1 A, 5 A, 10 A (depending upon model)
Rated Insulation voltage (Ui)	250 V
Rated impulse withstand voltage (Uimp)	1.5 kV
Pollution degree	3
Min. actuation speed	0.003 m/s
Max. actuation speed	0.1 m/s
Max. actuation frequency	ac – 200 Hz; dc – 20 Hz
Shock	50 g – IEC68-2-27
Vibration	10 G – IEC68-2-6
Approvals (914CE)	UL, CSA, CE
Conforming to standards	<ul style="list-style-type: none"> <li>• IEC947-5-1, EN 60947-5-1</li> <li>• UL recognized to US and Canadian Requirements (914CE only)</li> </ul>

## ELECTRICAL RATINGS

Model example	Contacts	Rating
914CE* - *	Silver contacts	A
914CE* - *G	Gold contacts	B
914CE* -Q, -AQ, -AQ1	Silver contacts	C

Rating Code	Electrical rating	Make	Break
A	UL/CSA	240 Vac, Ind.	1.2
		240 Vac, res.	5
		28 Vdc, res.	3
		28 Vdc, ind.	3
		5 A, 1/10 HP, 125 Vac or 250 Vac	
B	UL	1 A res., 0.5 A ind., 30 Vdc	
		1 A, 125 Vac	
C	UL/CSA	3 A, 125 Vac or 250 Vac	

# Compact Limit Switch

## SWITCHING AND LEAD IDENTIFICATION

### 914CE

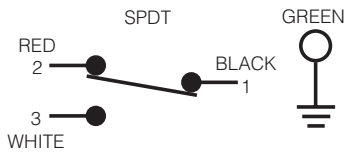

## PINOUTS

### Connector - (dc)



### Connector (ac)

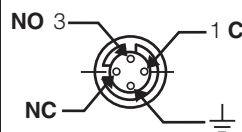

## CONNECTOR VERSIONS

The 914CE Series is available with a metal 4-pin, M12 size connector in both bottom and side exit versions.

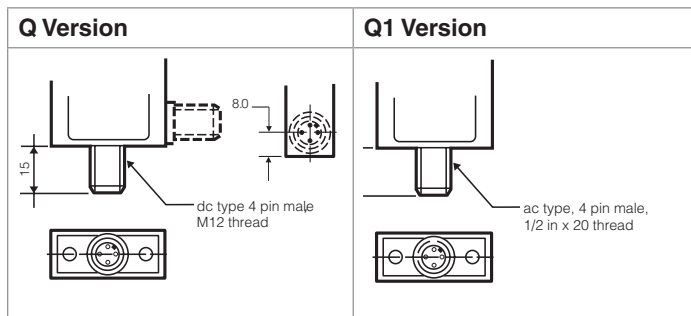

## MOUNTING

MICRO SWITCH™ 914CE Series switches are mounted by using two M5 screws. The mounting holes are counter bored to keep the screw heads within the overall switch housing dimensions.

## GANG MOUNT CAPABILITY

The housing on the 914CE Series has been designed to enable the user to build his own multiple plunger switch by gang mounting several switches. All pin plunger and roller plunger types are suitable for gang mounting. There is a 16 mm distance between the plungers. Both series are very versatile that even a lever-type version could be added at the end of the row.

## BOTTOM EXIT OR SIDE EXIT ORIENTATION

The CE Series has been designed with a pre-wired cable fitted in the bottom of the switch housing. Other variations are available with a side exit cable.

## GOLD CONTACT VERSIONS

For low current applications (up to 30 Vdc, 1 A), gold contact basic versions of the 914CE switches can be supplied upon request.

# MICRO SWITCH™ 914CE Series

## GENERAL DIMENSIONS • ALL SWITCHES

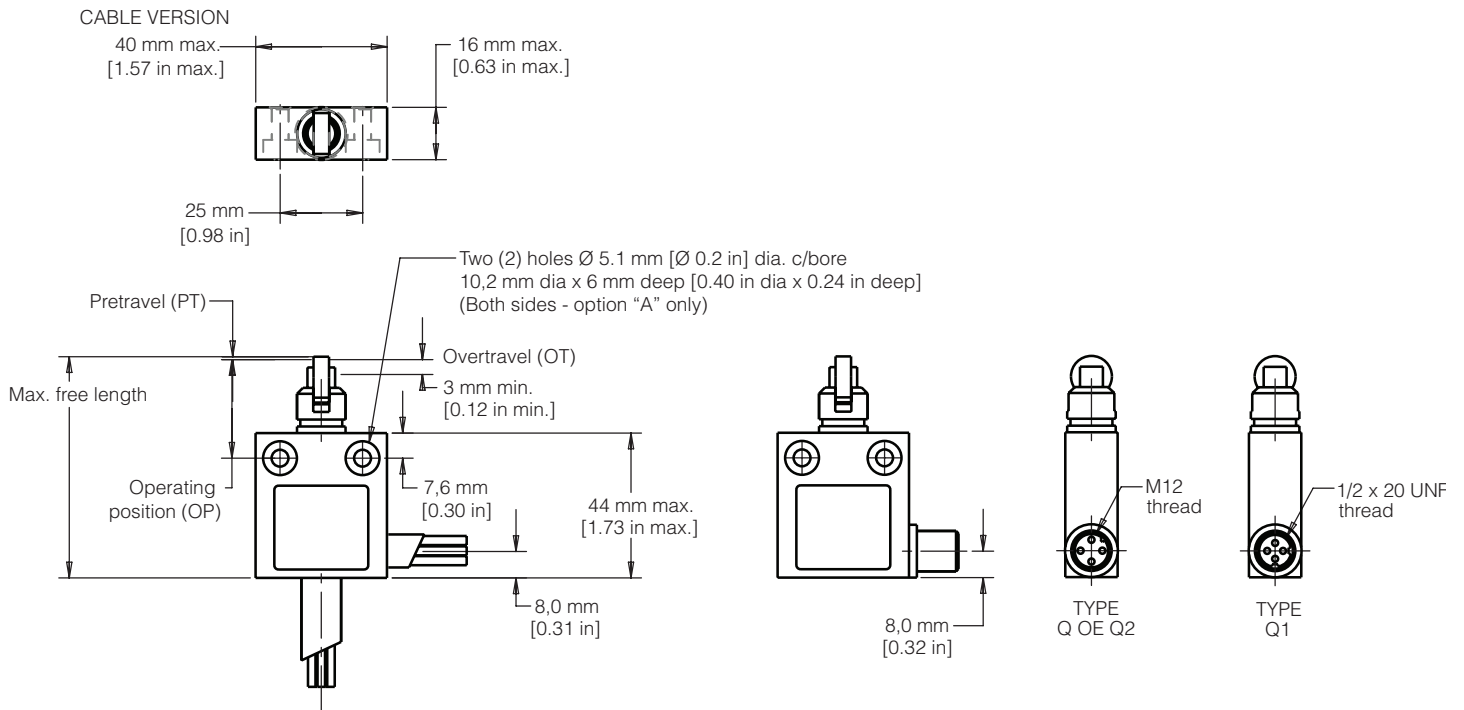

## PRODUCT NOMENCLATURE

914CE	29	—	3		
Switch Type	Actuator Type		Cable Length	Options	Connectors
<b>914CE Series</b> Small Precision Limit Switch	<b>1</b> Top pin plunger	<b>22</b> Manually oper. nylon button	<b>3</b> 3 feet	<b>A</b> Side entry	<b>Q</b> dc type Brad Harrison
	<b>2</b> Top roller plunger, parallel	<b>27</b> Top pin plunger panel mount	<b>6</b> 6 feet	<b>G</b> Gold contacts	<b>Q1</b> ac type two keyways
	<b>3</b> Top roller plunger, perp.	<b>28</b> Top roller plunger, parallel panel mount	<b>9</b> 9 feet	<b>P</b> Top mounting	<b>Q2</b> dc type plastic
	<b>16</b> Front rotary	<b>29</b> Top roller plunger, perp. panel mount	<b>12</b> 12 feet	<b>L1</b> Low temp. -40 °C, cable not for flexing	
	<b>18</b> Top pin plunger w/ boot seal	<b>31</b> Top roller plunger, parallel boot seal	<b>15</b> 15 feet	<b>V</b> Vitron seals/gasket (front rotary only)	
	<b>19</b> Top adjustable pin plunger	<b>55</b> Top roller plunger, perp. boot seal		Bottom exit is standard.	
	<b>20</b> Coil wobble	<b>66</b> Top ball bearing plunger			

NOTE: not all combinations of model code are available.  
 Please contact your Honeywell provider/representative for assistance.

# Compact Limit Switch

## PRODUCT SPECIFICATIONS AND LISTINGS

Contact your Honeywell rep or distributor for additional listings

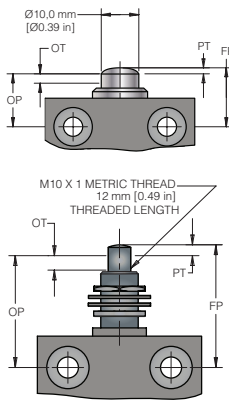
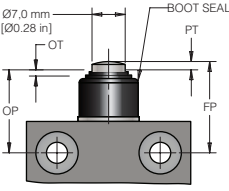
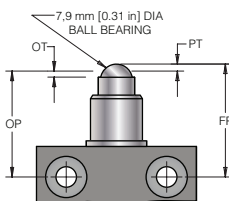
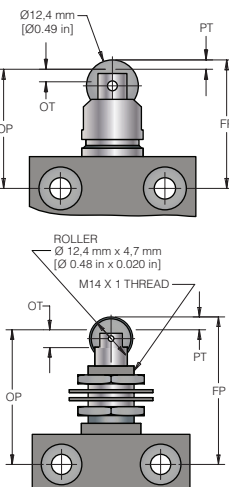
914CE1 • Pin Plunger 914CE27 • Pin Plunger Panel Mount		Con- tacts	Elec Rating	NEMA	Cable exit	Approvals	Options	Listing
 <p><b>Pretravel</b> • 1,8 mm [0.071 in] <b>Diff. travel</b> • 0,1 mm [0.004 in] <b>Overtravel</b> • 3,0 mm [0.118 in] <b>Oper. force</b> • 12,2 N [2.75 in-lb]</p>	Silver	A	1, 3	Bottom	UL, CSA, CE	–	<b>914CE1-3</b>	
	Gold	B	1, 3	Bottom	UL, CSA, CE	–	<b>914CE1-3G</b>	
	Silver	A	1, 3	Side	UL, CSA, CE	–	<b>914CE1-3A</b>	
	Silver	A	1, 3	Bottom	UL, CSA, CE	Panel mount	<b>914CE27-3</b>	
	Silver	C	1, 3	Bottom	UL, CSA, CE	ac-type, two keyways	<b>914CE1-Q1</b>	
914CE18 • Boot Sealed Pin Plunger		Con- tacts	Elec Rating	NEMA	Cable exit	Approvals	Options	Listing
 <p><b>Pretravel</b> • 1,8 mm [0.071 in] <b>Diff. travel</b> • 0,1 mm [0.004 in] <b>Overtravel</b> • 3,0 mm [0.118 in] <b>Oper. force</b> • 22,2 N [5 in-lb]</p>	Silver	A	1, 3, 4, 12, 13	Bottom	UL, CSA, CE		<b>914CE18-3</b>	
	Silver	A	1, 3, 4, 12, 13	Side	UL, CSA, CE		<b>914CE18-3A</b>	
	Silver	A	1, 3, 4, 12, 13	Bottom	UL, CSA, CE	Fluorocarbon seals	<b>914CE18-3V</b>	
	Silver	C	1, 3, 4, 6, 12, 13	Bottom	UL, CSA, CE	ac-type, two keyways	<b>914CE18-Q1</b>	
	Silver	C	1, 3, 4, 6, 12, 13	Side	UL, CSA, CE	ac-type, two keyways	<b>914CE18-AQ1</b>	
914CE66 • Ball Bearing Plunger		Con- tacts	Elec Rating	NEMA	Cable exit	Approvals	Options	Listing
 <p><b>Pretravel</b> • 1,8 mm [0.071 in] <b>Diff. travel</b> • 0,1 mm [0.004 in] <b>Overtravel</b> • 3,0 mm [0.118 in] <b>Oper. force</b> • 12,2 N [2.75 in-lb]</p>	Silver	A	1, 3	Bottom	UL, CSA, CE		<b>914CE66-3</b>	
914CE2 • Roller Plunger 914CE28 • Roller Plunger Panel Mount		Con- tacts	Elec Rating	NEMA	Cable exit	Approvals	Options	Listing
 <p><b>Pretravel</b> • 1,8 mm [0.071 in] <b>Diff. travel</b> • 0,1 mm [0.004 in] <b>Overtravel</b> • 3,0 mm [0.118 in] <b>Oper. force</b> • 12,2 N [2.75 in-lb]</p>	Silver	A	1, 3	Bottom	UL, CSA, CE		<b>914CE2-3</b>	
	Gold	B	1, 3	Bottom	UL, CSA, CE		<b>914CE2-3G</b>	
	Silver	C	1, 3	Bottom	UL, CSA, CE	ac-type, two keyways	<b>914CE2-Q1</b>	
	Silver	A	1, 3	Side	UL, CSA, CE		<b>914CE2-3A</b>	
	Silver	A	1, 3	Bottom	UL, CSA, CE	Panel mount	<b>914CE28-3</b>	
	Silver	C	1, 3	Bottom	UL, CSA, CE	Panel mount, ac-type, two keyways	<b>914CE28-Q1</b>	

# MICRO SWITCH™ 914CE Series

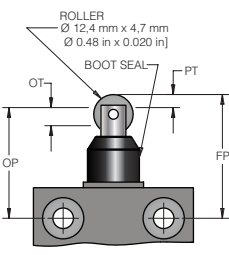
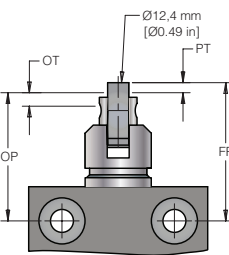
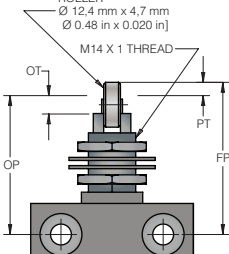
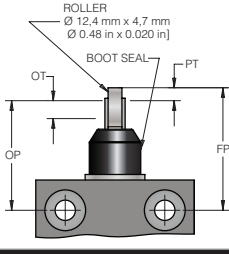
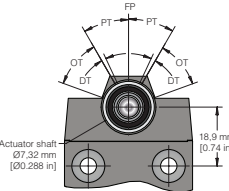
914CE31 • Boot Sealed Roller Plunger		Con-tacts	Elec Rating	NEMA	Cable exit	Approvals	Options	Listing
 <p><b>Pretravel</b> • 1,8 mm [0.071 in]  <b>Diff. travel</b> • 0,1 mm [0.004 in]  <b>Overtravel</b> • 3,0 mm [0.118 in]  <b>Oper. force</b> • 22,2 N [5 in-lb]</p>	Silver	A	1, 3, 4, 6, 6P, 12, 13	Bottom	UL, CSA, CE		<b>914CE31-3</b>	
	Silver	A	1, 3, 4, 6, 6P, 12, 13	Bottom	UL, CSA, CE	Fluorocarbon seals	<b>914CE31-3V</b>	
914CE3 • Cross Roller Plunger 914CE29 • Cross Roller Panel Mount		Con-tacts	Elec Rating	NEMA	Cable exit	Approvals	Options	Listing
 <p><b>Pretravel</b> • 1,8 mm [0.071 in]  <b>Diff. travel</b> • 0,1 mm [0.004 in]  <b>Overtravel</b> • 3,0 mm [0.118 in]  <b>Oper. force</b> • 12,2 N [2.75 in-lb]</p> 	Silver	A	1, 3	Bottom	UL, CSA, CE		<b>914CE3-3</b>	
	Gold	B	1, 3	Bottom	UL, CSA, CE		<b>914CE3-3G</b>	
	Silver	A	1, 3	Side	UL, CSA, CE		<b>914CE3-3A</b>	
	Silver	A	1, 3	Bottom	UL, CSA, CE	Panel mount	<b>914CE29-3</b>	
	Silver	C	1, 3	Bottom	UL, CSA, CE	ac-type, two keyways	<b>914CE3-Q1</b>	
914CE55 • Boot Sealed Cross Roller Plunger		Con-tacts	Elec Rating	NEMA	Cable exit	Approvals	Options	Listing
 <p><b>Pretravel</b> • 1,8 mm [0.071 in]  <b>Diff. travel</b> • 0,1 mm [0.004 in]  <b>Overtravel</b> • 3,0 mm [0.118 in]  <b>Oper. force</b> • 22,2 N [5 in-lb]</p>	Silver	A	1, 3, 4, 6, 6P, 12, 13	Bottom	UL, CSA, CE		<b>914CE55-3</b>	
914CE16 • Side Rotary		Con-tacts	Elec Rating	NEMA	Cable exit	Approvals	Options	Listing
 <p><b>Pretravel</b> • 1,8 mm [0.071 in]  <b>Diff. travel</b> • 0,1 mm [0.004 in]  <b>Overtravel</b> • 3,0 mm [0.118 in]  <b>Oper. force</b> • 22,2 N [5 in-lb]</p>	Silver	A	1, 3, 4, 6, 6P, 12, 13	Bottom	UL, CSA, CE		<b>914CE16-3<sup>1</sup></b>	
	Silver	A	1, 3, 4, 6, 6P, 12, 13	Side	UL, CSA, CE		<b>914CE16-3A<sup>1</sup></b>	
	Silver	C	1, 3, 4, 6, 12, 13	Bottom	UL, CSA, CE	ac-type, two keyways	<b>914CE16-Q1<sup>1</sup></b>	
	Silver	C	1, 3, 4, 6, 12, 13	Side	UL, CSA, CE	ac-type, two keyways	<b>914CE16-AQ1<sup>1</sup></b>	

Note: part numbers are shown with 3 ft of cable. The -X indicates the number of feet of cable provided. Six-foot, 9-foot lengths, and 12-foot lengths along with custom amounts, are also available.

<sup>1</sup> Switch operates on clockwise and counterclockwise rotation of lever shaft

# Compact Limit Switch

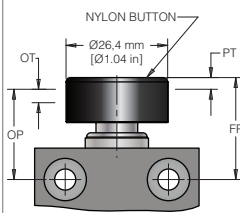
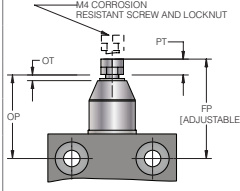
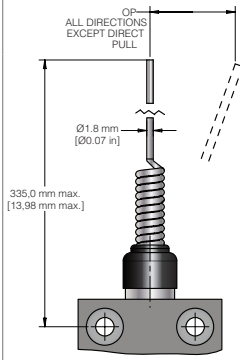
914CE22 • Manually Operated		Con-tacts	Elec Rating	NEMA	Cable exit	Approvals	Options	Listing
 <p><b>Pretravel</b> • 1,8 mm [0.071 in]  <b>Diff. travel</b> • 0,1 mm [0.004 in]  <b>Overtravel</b> • 3,0 mm [0.118 in]  <b>Oper. force</b> • 8,9 N [2 in-lb]</p>	Silver	A	1, 3	Bottom	UL, CSA, CE	23,9 mm [0.94 in] dia. button	<b>914CE22-3</b>	
914CE19 • Adjustable Plunger		Con-tacts	Elec Rating	NEMA	Cable exit	Approvals	Options	Listing
 <p><b>Diff. travel</b> • 0,1 mm [0.004 in]  <b>Overtravel</b> • 3,0 mm [0.118 in]  <b>Oper. force</b> • 17,5 N [5 lb]</p>	Silver	A	1, 3	Bottom	UL, CSA, CE		<b>914CE19-3</b>	
	Gold	B	1, 3	Bottom	UL, CSA, CE		<b>914CE19-3G</b>	
	Silver	A	1, 3	Side	UL, CSA, CE		<b>914CE19-3A</b>	
	Silver	C	1, 3	Bottom	UL, CSA, CE	ac-type, two keyways	<b>914CE19-Q1</b>	
914CE20 • Random Motion Wire Actuator		Con-tacts	Elec Rating	NEMA	Cable exit	Approvals	Options	Listing
 <p><b>Pretravel</b> • 1,0 mm ±0,5 mm [0.04 in ±0.02 in]  <b>Diff. travel</b> • 0,1 mm [0.004 in]  <b>Overtravel</b> • 3,0 mm [0.118 in]  <b>Oper. force</b> • 0,55 N [0.12 lb]</p>	Silver	A	1, 2, 3, 3R, 4, 6, 6P, 13	Bottom	UL, CSA, CE		<b>914CE20-3</b>	
	Silver	A	1, 2, 3, 3R, 4, 6, 6P, 13	Side	UL, CSA, CE		<b>914CE20-3A</b>	

Note: part numbers are shown with 3 ft of cable. The -X indicates the number of feet of cable provided. Six-foot, 9-foot lengths, and 12-foot lengths along with custom amounts, are also available.

<sup>1</sup> Switch operates on clockwise and counterclockwise rotation of lever shaft

# MICRO SWITCH™ 914CE Series

This Honeywell datasheet supports the following MICRO SWITCH™ 914CE Series Limit Switch Listings

914CE1-15	914CE2-12	914CE3-Q1	914CE3-6K
914CE1-3	914CE2-12GKL1	914CE55-12	914CE3-9AK
914CE1-3A	914CE2-15	914CE55-3	914CE3-9G
914CE1-3G	914CE22-12	914CE66-3	914CE3-9K
914CE1-6	914CE22-6	914CE66-6	914CE3-9V
914CE16-12	914CE2-27	914CE1-12	914CE3-AKQ
914CE16-18	914CE2-3	914CE1-12A	914CE3-KQ1
914CE16-18V	914CE2-33N37	914CE1-15A	914CE31-12AV
914CE16-27	914CE2-3A	914CE1-3AK	914CE31-3A
914CE16-3	914CE2-3AL1	914CE1-3AKV	914CE31-3V
914CE16-3A	914CE2-3L1	914CE1-3K	914CE55-3AG
914CE16-3N1	914CE2-6	914CE1-AKQ	914CE553A
914CE16-6	914CE2-6A	914CE1-AKQ1	914CE66-12
914CE16-6A	914CE2-6-C	914CE1-GQ1	914CE66-9
914CE16-6AN14	914CE2-6G	914CE1-KQ	
914CE16-9	914CE27-3	914CE1-KQ1	
914CE16-9A	914CE27-6	914CE18-21A	
914CE1-6A	914CE27-GQ1	914CE18-9V	
914CE16-AQ	914CE27-Q	914CE18-GQ	
914CE1-6L1	914CE28-12	914CE2-12AK	
914CE16-Q	914CE28-18	914CE2-12GK	
914CE16-Q1	914CE28-3	914CE2-12KL1	
914CE16-Q2	914CE28-6	914CE2-15A	
914CE16-QV	914CE28-9	914CE2-18	
914CE16-VCQ1	914CE28-Q	914CE2-21	
914CE18-12	914CE2-9	914CE2-24K	
914CE18-15	914CE29-3	914CE2-33	
914CE18-15A	914CE29-6	914CE2-33AK	
914CE18-27	914CE29-9L1	914CE2-33K	
914CE18-3	914CE2-9A	914CE2-3AK	
914CE18-3A	914CE2-9AL1	914CE2-3G	
914CE18-3AL1	914CE2-9C	914CE2-3K	
914CE18-6	914CE2-9G	914CE2-3KL1	
914CE18-6A	914CE2-9L1	914CE2-3KV	
914CE18-9	914CE29-Q	914CE2-6AK	
914CE18-9A	914CE2-AGQ	914CE2-6K	
914CE18-9AGL1	914CE2-AQ	914CE2-6KV	
914CE18-9AL1	914CE2-KQ	914CE2-9AK	
914CE18-AQ	914CE2-Q	914CE2-9K	
914CE18-AQ1	914CE2-Q1	914CE2-9KL1	
914CE18-Q	914CE2-Q2	914CE2-AKLV	
914CE18-Q1	914CE31-12	914CE2-AKQV	
914CE1-9	914CE31-12A	914CE2-AQ1	
914CE19-12	914CE31-18	914CE2-KQ1	
914CE19-3	914CE3-12	914CE2-KQV	
914CE19-6	914CE31-3	914CE20-12G	
914CE19-9	914CE31-3L1	914CE20-12GL1	
914CE19-9A	914CE31-6	914CE22-3	
914CE1-9A	914CE31-9AL1	914CE22-9	
914CE1-AQ	914CE31-9L1	914CE27-12	
914CE1-AQ1	914CE31-9V	914CE27-9	
914CE1-Q	914CE31-AQ	914CE27-AGQ1	
914CE1-Q1	914CE3-3	914CE28-Q1	
914CE1-Q2	914CE3-3A	914CE29-9	
914CE20-12	914CE3-3L1	914CE3-12AK	
914CE20-3	914CE3-6	914CE3-12K	
914CE20-6	914CE3-6A	914CE3-3AK	
914CE20-9	914CE3-9	914CE3-3G	
914CE20-9L1	914CE3-9L1	914CE3-3K	
914CE20-N77	914CE3-AQ	914CE3-3KL1	
914CE20-Q	914CE3-KQ	914CE3-6AK	
914CE20-Q1	914CE3-Q	914CE3-6G	



# MICRO SWITCH™ 914CE Series

Compact Limit Switch

**Warranty.** Honeywell warrants goods of its manufacture as being free of defective materials and faulty workmanship. Honeywell's standard product warranty applies unless agreed to otherwise by Honeywell in writing; please refer to your order acknowledgement or consult your local sales office for specific warranty details. If warranted goods are returned to Honeywell during the period of coverage, Honeywell will repair or replace, at its option, without charge those items it finds defective. **The foregoing is buyer's sole remedy and is in lieu of all warranties, expressed or implied, including those of merchantability and fitness for a particular purpose. In no event shall Honeywell be liable for consequential, special, or indirect damages.**

While we provide application assistance personally, through our literature and the Honeywell web site, it is up to the customer to determine the suitability of the product in the application.

Specifications may change without notice. The information we supply is believed to be accurate and reliable as of this printing. However, we assume no responsibility for its use.

## Find out more

Honeywell serves its customers through a worldwide network of sales offices, representatives and distributors. For application assistance, current specifications, pricing or name of the nearest Authorized Distributor, contact your local sales office. To learn more about Honeywell's sensing and control products, call **+1-815-235-6847/1-800-537-6945**, visit **sensing.honeywell.com**, or e-mail inquiries to **info.sc@honeywell.com**

Sensing and Control  
Honeywell  
1985 Douglas Drive North  
Golden Valley, MN 55422 USA  
**sensing.honeywell.com**

## WARNING

### MISUSE OF DOCUMENTATION

- The information presented in this datasheet is for reference only. DO NOT USE this document as product installation information.
- Complete installation, operation and maintenance information is provided in the instructions supplied with each product.

**Failure to comply with these instructions could result in death or serious injury.**

## WARNING

### PERSONAL INJURY

DO NOT USE these products as safety or emergency stop devices or in any other application where failure of the product could result in personal injury.

**Failure to comply with these instructions could result in death or serious injury.**

# Honeywell