**»» Features**

- Mini ISO high power automotive relay 30A/50A.
- High temperature endurance up to 125 degree C.
- Optional SPNC, SPNO, SPDT, DPNO contact configurations.
- Optional to be equipped with protection diode or resistor.
- Both available PCB terminal and quick connect terminal versions.
- Available for plain cover type, skirted cover flanged cover, and weather proof versions.
- Tinned terminal is available on request.
- Comply with RoHS-Directive 2002/95/EC, and ELV-Directive 2000/53/EC.

**»» Type List**

Terminal style	Contact form	Enclosure style		
		Dust cover	Flux tight	Sealed type washable
Socket terminal	1A (SPNO)	896-1AH-D	896-1AH-C	896-1AH-S
		896H-1AH-D	896H-1AH-C	896H-1AH-S
	1C (SPDT)	896-1CH-D	896-1CH-C	896-1CH-S
		896H-1CH-D	896H-1CH-C	896H-1CH-S
	2A (DPNO)	896-2AH-D	896-2AH-C	896-2AH-S
		896H-2AH-D	896H-2AH-C	896H-2AH-S
PCB terminal	1A (SPNO)	896P-1AH-D	896P-1AH-C	896P-1AH-S
		896HP-1AH-D	896HP-1AH-C	896HP-1AH-S
	1C (SPDT)	896P-1CH-D	896P-1CH-C	896P-1CH-S
		896HP-1CH-D	896HP-1CH-C	896HP-1CH-S
	2A (DPNO)	896P-2AH-D	896P-2AH-C	896P-2AH-S
		896HP-2AH-D	896HP-2AH-C	896HP-2AH-S

Terminal style	Contact form	Enclosure style	
		Flanged cover (dust cover)	Flanged cover (flux tight)
Socket terminal	1A (SPNO)	896-1AH-D1	896-1AH-C1
		896H-1AH-D1	896H-1AH-C1
	1C (SPDT)	896-1CH-D1	896-1CH-C1
		896H-1CH-D1	896H-1CH-C1
	2A (DPNO)	896-2AH-D1	896-2AH-C1
		896H-2AH-D1	896H-2AH-C1

Terminal style	Contact form	Enclosure style	
		Steel bracket ( dust cover)	Steel bracket (flux tight)
Socket terminal	1A (SPNO)	896-1AH-D1S	896-1AH-C1S
		896H-1AH-D1S	896H-1AH-C1S
	1C (SPDT)	896-1CH-D1S	896-1CH-C1S
		896H-1CH-D1S	896H-1CH-C1S
	2A (DPNO)	896-2AH-D1S	896-2AH-C1S
		896H-2AH-D1S	896H-2AH-C1S

Terminal style	Contact form	Designation (provided with)	Enclosure style	
			Steel bracket ( dust cover with shroud)	Steel bracket ( dust cover with weather proof)
Socket terminal	1C (SPDT)	Resistor	896H-1CH-D1SF-R1	896H-1CH-D1SW-R1

### »» Ordering Information

896      H      P      -      1CH      -      C      -      R1      -      T      001  
 1          2          3          4          5          6          7          8

- |    |       |  |      |   |                  |
|----|-------|--|------|---|------------------|
| 1. | 896   | -- Basic series designation                            | D1S  | -- Steel bracket (dust cover)   |                  |
| 2. | Blank | -- Standard type                                       | C1S  | -- Steel bracket (flux tight)   |                  |
|    | H     | -- High power type                                     | S1S  | -- Steel bracket (sealed type washable)                                   |                  |
| 3. | Blank | -- Socket terminal                                     | D1SF | -- Steel bracket (dust cover with shroud)                                 |                  |
|    | P     | -- PCB terminal  | D1SW | -- Steel bracket (dust cover with weather proof)                          |                  |
| 4. | 1AH   | -- Single pole normally open, contact material AgSnO   | 6.   | Blank   | -- Standard type |
|    | 1BH   | -- Single pole normally closed, contact material AgSnO | R1   | -- Coil parallel with resistor 1/2W for 12V 680Ω , 24V 2700Ω              |                  |
|    | 1CH   | -- Single pole double throw, contact material AgSnO    | 7.   | Blank   | -- Standard type |
|    | 2AH   | -- Double pole double make, contact material AgSnO     | T    | -- Special requirement for Tin plated terminal                            |                  |
| 5. | D     | -- Dust cover  | 8.   | Blank   | -- Standard type |
|    | C     | -- Flux tight  | 001  | -- Coil parallel with diode IN4007 the positive pole "+" on # 85 terminal |                  |
|    | S     | -- Sealed type washable                                | 002  | -- Coil parallel with diode IN4007 the negative pole "-" on # 85 terminal |                  |
|    | C1    | -- Flanged cover (flux tight)                          |      |   |                  |
|    | D1    | -- Flanged cover (dust cover)                          |      |   |                  |
|    | S1    | -- Flanged cover (sealed type washable)                |      |   |                  |

### »» Contact Rating

Type	896 1A	896 1B	896 1C	896 2A
Resistive load	40A 14VDC	40A 14VDC	NO : 40A 14VDC NC : 30A 14VDC	2×15A 14VDC

Type	896H 1A	896H 1B	896H 1C	896H 2A
Resistive load	50A 14VDC 20A 28VDC	40A 14VDC 15A 28VDC	NO : 50A 14VDC, 20A 28VDC NC : 30A 14VDC, 15A 28VDC	2×30A 14VDC 2×10A 28VDC

### »» Coil Rating(DC)

Rated voltage (V)	Rated current ±10 % at 23°C (mA)	Coil resistance ±10 % at 23°C (Ω)	Max. continuous Voltage at 85°C <sup>(1)</sup>	Pick up voltage(Max) at 23°C	Drop out voltage(Min) at 23°C	Power consumption at rated voltage
12	133	90	120 % of rated voltage	65 % of rated voltage	10 % of rated voltage	approx. 1.6W
24	66.7	360				

Notes : (1) Without switching the load.

### »» Specification

Contact material	AgSnO alloy	
Contact voltage drop <sup>(1)</sup>	Typ. 50mV at 10A	
Insulation resistance <sup>(1)</sup>	20MΩ Min. (DC 500V)	
Operate time <sup>(1)</sup>	20ms Max.	
Release time <sup>(1)</sup>	20ms Max.	
Dielectric strength <sup>(1)</sup>	Between open contact	: AC 500V , 50/60Hz 1 min.
	Between contact and coil	: AC 500V , 50/60Hz 1 min.
Vibration resistance	Operating extremes	10~55Hz , amplitude 2mm
Shock resistance	Operating extremes	10G
	Damage limits	100G
Life expectancy	Mechanical	10,000,000 operations (frequency 18,000 operations/hr)
	Electrical	100,000 operations (frequency 1,200 operations/hr)
Temperature range	Operating	-40~+125°C (no freezing)
Weight	Approx. 40 g	

Note : (1) initial value

## »» Outline Dimensions

### ◆ 896,896H (C,D,S)

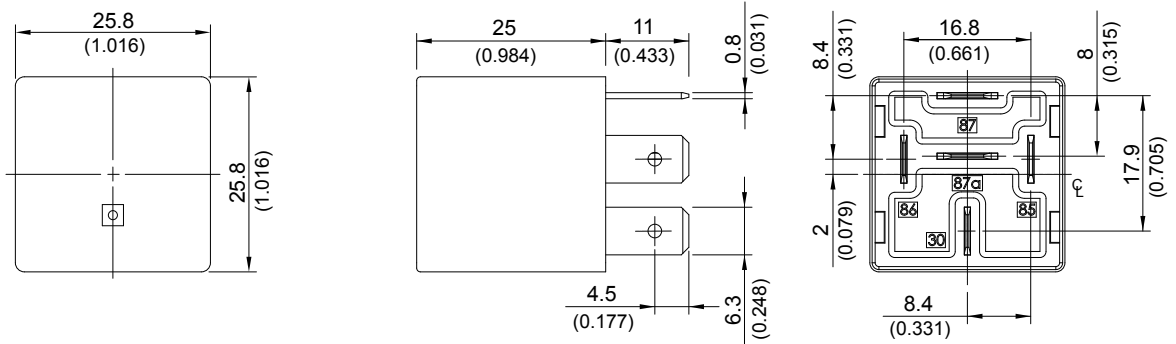

### ◆ 896,896H (C1,D1,S1)

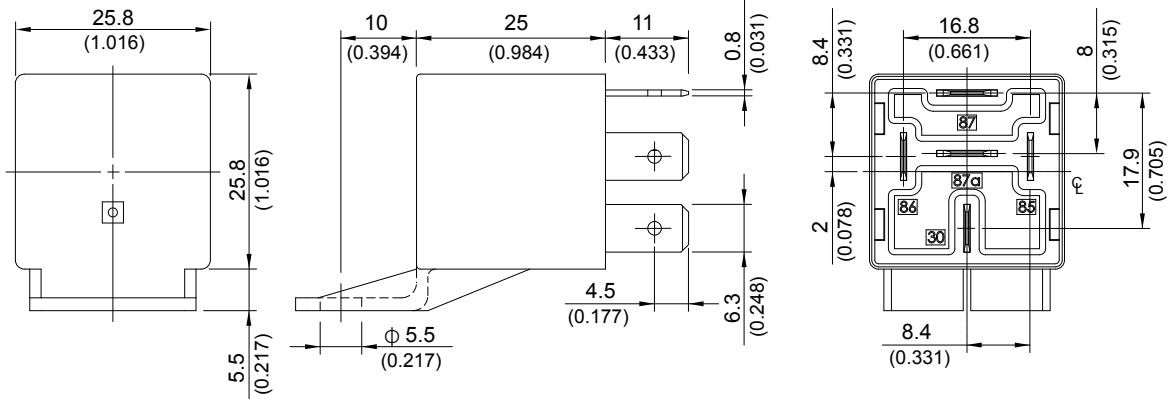

### ◆ 896,896H (C1S,D1S,S1S)

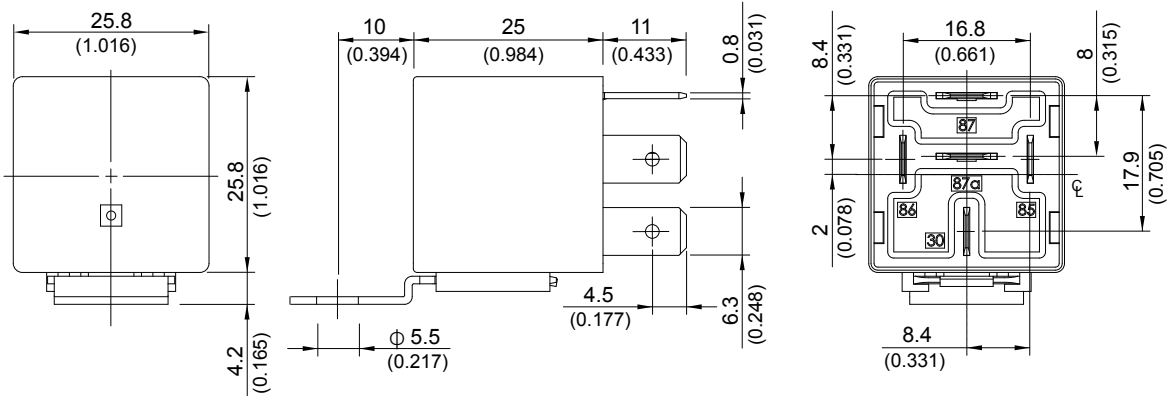

### ◆ 896P,896HP (C,D,S)

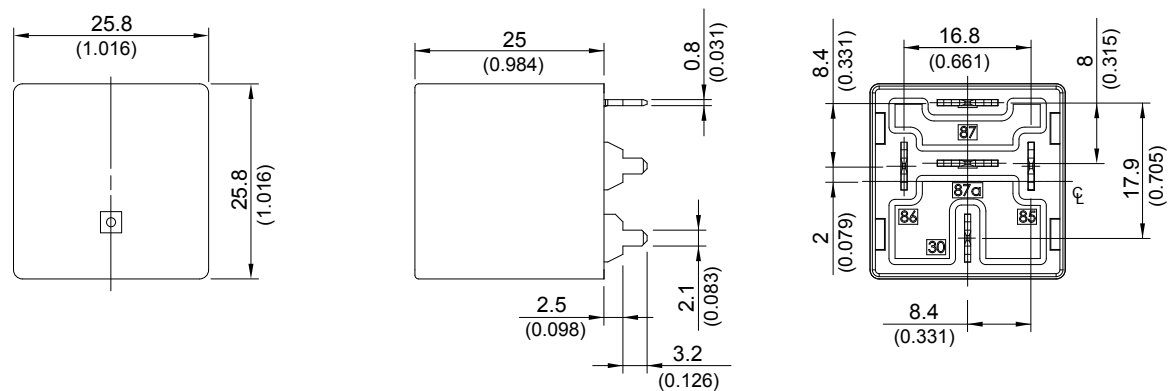

◆ 896H (D1SW)

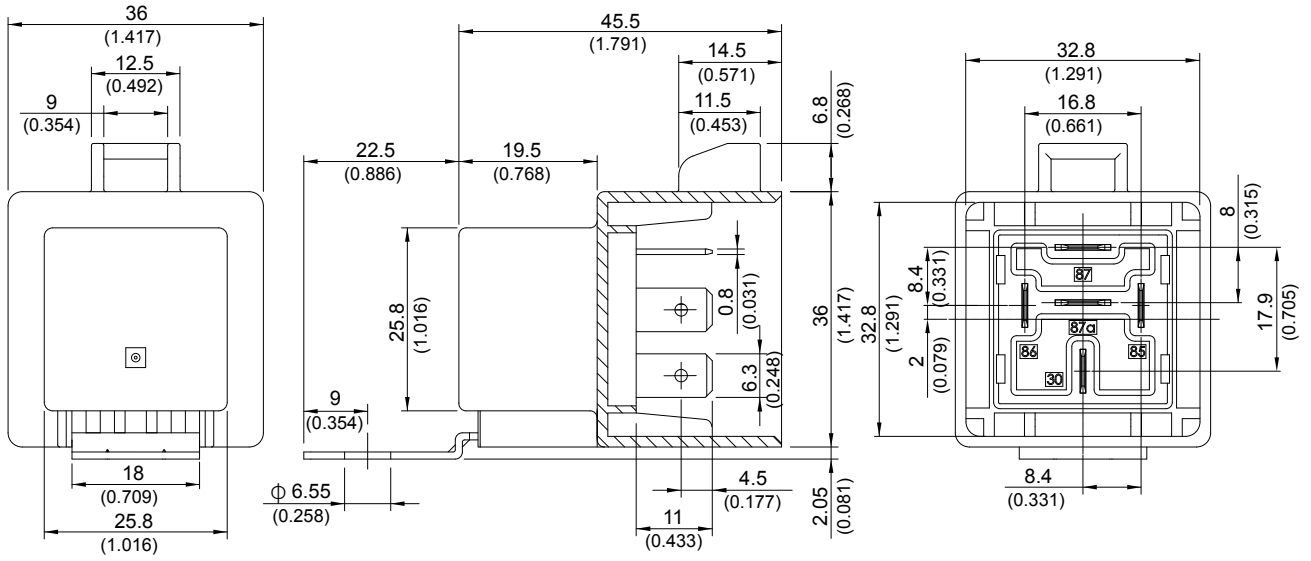

◆ 896H (D1SF)

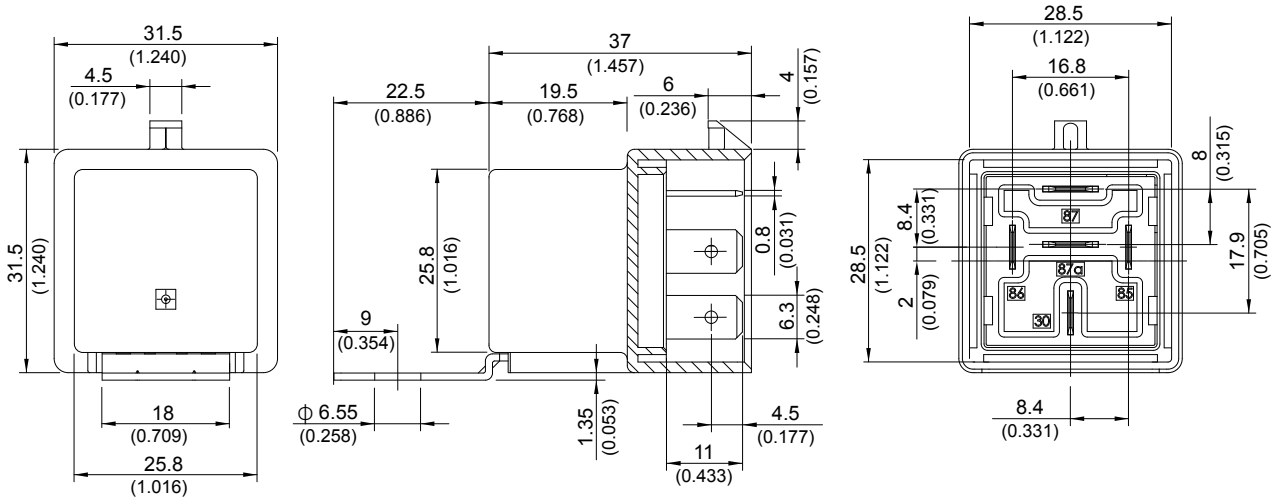

»» Wiring Diagram

BOTTOM VIEW

1A

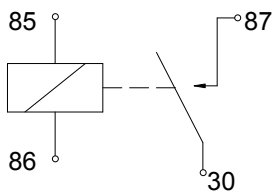

1B

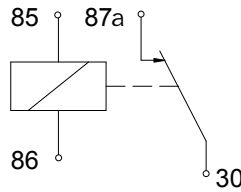

1C

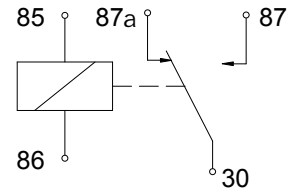

2A

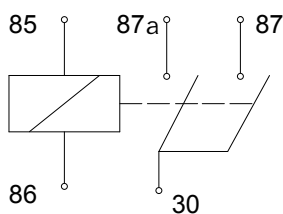

R1

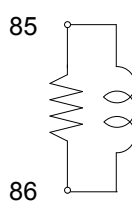

001

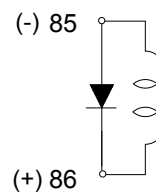

002

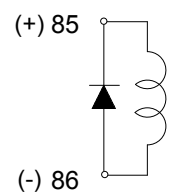

## »» PC Board Layout

BOTTOM VIEW

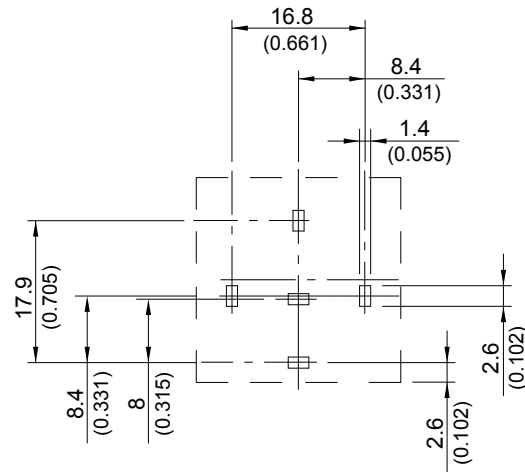

## »» Engineering Data

