

Data sheet | Item number: 852-1328 **NEW**

Industrial-Managed-Switch; 6-Port 1000BASE-T; 2-Slot 1000BASE-SX/LX;  
MAC Security; light gray

[www.wago.com/852-1328](http://www.wago.com/852-1328)

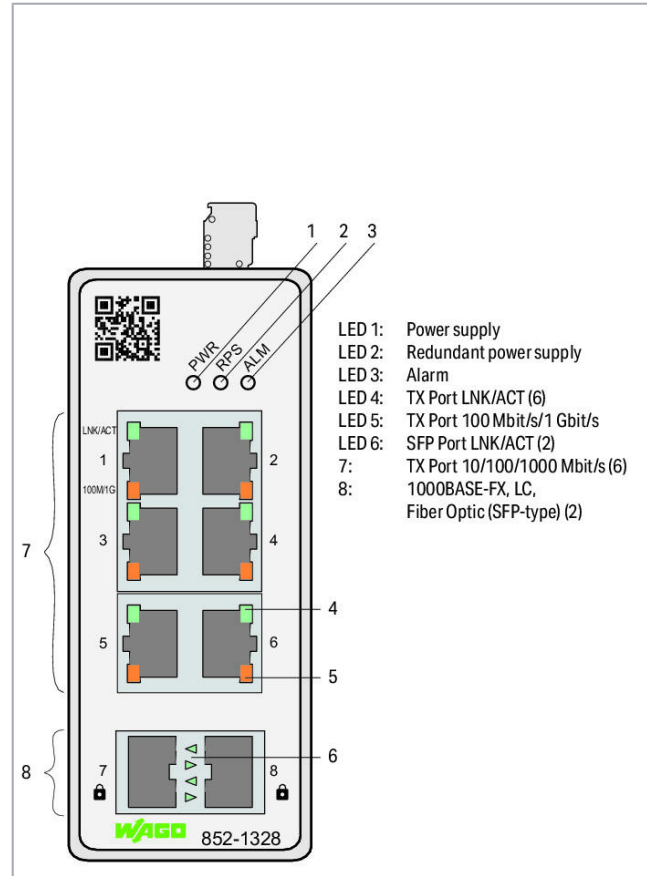

Subject to changes. Please also observe the further product documentation!

WAGO Kontakttechnik GmbH & Co. KG  
Hansastr. 27  
32423 Minden  
Phone: +49571 887-0 | Fax: +49571 887-169  
Email: [info.de@wago.com](mailto:info.de@wago.com) | Web: [www.wago.com](http://www.wago.com)

Do you have any questions about our products?  
We are always happy to take your call at +49 (571) 887-44222.

RoHS  Compliant    BOMcheck.net    Color:

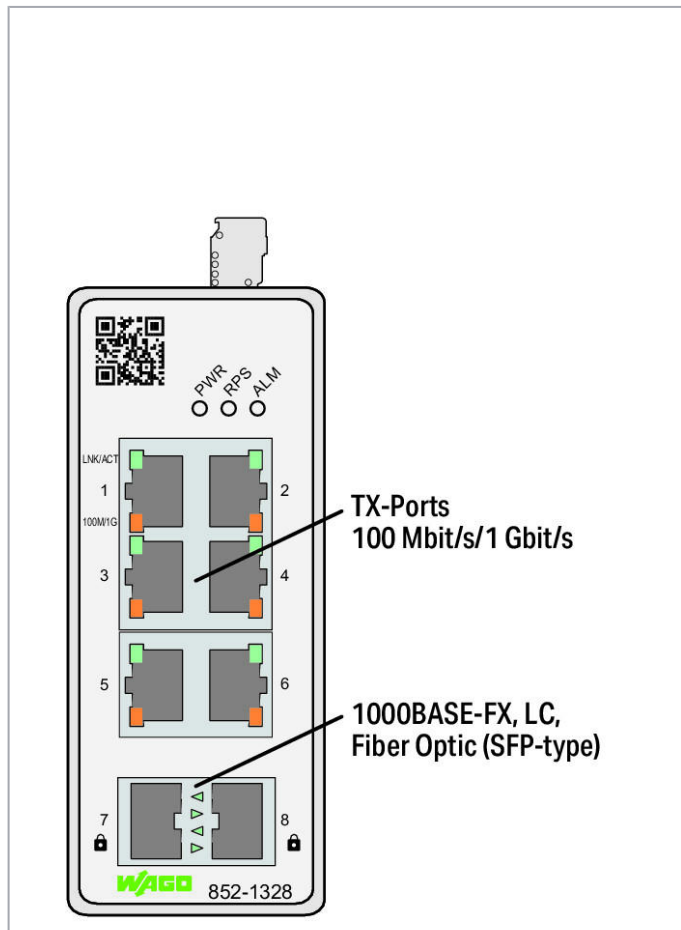

### Item description

The 852-1328 Industrial Managed Switch is a 6-port 10/100/1000BASE-T and 2-port SFP-1000BASE-SX/LX configurable ETHERNET switch (SFP modules are optional). Data encryption complies with IEEE802.1AE (MAC Security Standard) for communication via SFP slots (ports 7 and 8). This functionality, combined with compact dimensions, makes WAGO's managed switch ideal for retrofitting network security during operation of the automation system. The customer application remains unchanged. The optional authentication of the other participants in the network is port-specific in accordance with IEEE 802.1X and RADIUS server.

Packaged in a rugged housing, this switch offers a redundant power supply.

### Features:

- Web-based (HTTP(S))
- Configuration and diagnostics via SNMPv3

Subject to changes. Please also observe the further product documentation!

WAGO Kontakttechnik GmbH & Co. KG

Hansastr. 27

32423 Minden

Phone: +49571 887-0 | Fax: +49571 887-169

Email: [info.de@wago.com](mailto:info.de@wago.com) | Web: [www.wago.com](http://www.wago.com)

Do you have any questions about our products?

We are always happy to take your call at +49 (571) 887-44222.



- Redundant DC power supply
- Supply voltage range: 9 ... 48 VDC
- Full compliance with IEEE802.3, 802.3u, 802.3z, 802.3x, 802.3ab, 802.1p, 802.1X, 802.3az, 802.1AE standards
- Non-blocking, store-and-forward switching
- Auto-negotiation at all 10/100/1000BASE-T ports
- Auto-MDI/MDIX (crossover) at all 10/100/1000Base-T ports
- SNMP v1/v2c/v3

## Data

### Technical Data

Switching mode	Store-and-forward; non-blocking
Number of 1000Base-T ports	6
Number of 1000Base SX/LX ports	2
Communication standards	IEEE 802.3 10BASE-T IEEE 802.3u 100BASE-TX IEEE 802.3ab 1000BASE-T IEEE 802.3z 1000BASE-SX/LX IEEE 802.3x Flow Control IEEE 802.1p Prioritization IEEE 802.1x Port Authentication IEEE 802.3az Energy Efficient Ethernet IEEE 802.1AE MAC Security
Redundancy function	Redundant DC power supply
Configuration options	Web-based (HTTP(S)) SNMPv1/v2c/v3
Diagnostics	Modbus TCP; Port status; Syslog; SNMP traps
MAC table (size)	16000 addresses
Supply voltage	DC 9 ... 48 V
Power consumption (max.)	5.8 W
ESD (contact/air discharge)	8 KV / 15 KV
Baud rate	Copper cable: 10/1000 Mbit/s; Fiber optic:1000 Mbit/s
Indicators	Device: LED (PWR, RPS) green: Power supply (primary), redundant power supply (secondary); LED (ALM) red: Alarm; per port: LED (100M/1G, LNK/ACT) green: Status 100 Mbit/s/1 Gbit/s, LNK/ACT ports 1 ... 6; LED port 7, 8 green: Status of fiber optic ports

### Connection data

Connection technology: communication/fieldbus	Copper cable: 6 x RJ-45; Fiber optic: 2 x SFP; LC fiber-optic connector
Connection technology: supply	1 x Built-in male connector: 231-435/001-000; included female

Subject to changes. Please also observe the further product documentation!



connector (MCS Connectors): 2231-105/026-000

**Physical data**

Width	45.3 mm / 1.783 inch
Height	110 mm / 4.331 inch
Depth	89.6 mm / 3.528 inch
Depth from upper edge of DIN-rail	92 mm / 3.622 inch

**Mechanical data**

Weight	639 g
Color	light gray

**Environmental Requirements**

Surrounding air temperature (operation)	-20 ... 70 °C
Surrounding air temperature (storage)	-40 ... 80 °C
Protection type	IP30
Relative humidity (without condensation)	95 %
Mounting type	DIN-35 rail
Vibration resistance	per IEC 60068-2-6
Shock resistance	per IEC 60068-2-27
EMC immunity to interference	per EN 61000-6-2
EMC emission of interference	per EN 55011; 55024; 55032 (Class A + B); 61000-6-3, -4

**Commercial data**

Packaging type	BOX
Country of origin	TW
GTIN	4055143978415
Customs tariff number	85176200000

**Counterpart****Compatible products****General accessories**

Subject to changes. Please also observe the further product documentation!

WAGO Kontakttechnik GmbH & Co. KG  
Hansastr. 27  
32423 Minden  
Phone: +49571 887-0 | Fax: +49571 887-169  
Email: [info.de@wago.com](mailto:info.de@wago.com) | Web: [www.wago.com](http://www.wago.com)

Do you have any questions about our products?  
We are always happy to take your call at +49 (571) 887-44222.

 **Item no.: 852-1200**  
SFP Module 1000BASE; SX Multi-Mode 850 nm LC; 0.55 km; Extended temperature range; DDM; silver-colored [www.wago.com/852-1200](http://www.wago.com/852-1200)

 **Item no.: 852-1210**  
SFP Module 1000BASE; LX Single-Mode 1310 nm LC; 10 km; Extended temperature range; DDM; silver-colored [www.wago.com/852-1210](http://www.wago.com/852-1210)

 **Item no.: 852-1280**  
SFP Module 1000BASE; ZX Single-Mode 1550 nm LC; 80 km; Extended temperature range; DDM; silver-colored [www.wago.com/852-1280](http://www.wago.com/852-1280)

 **Item no.: 852-201/107-002** [www.wago.com/852-201/107-002](http://www.wago.com/852-201/107-002)  
SFP module 2: 1310nm; 100Base-FX Multi-Mode LC; 2 km; silver-colored

 **Item no.: 852-201/107-030** [www.wago.com/852-201/107-030](http://www.wago.com/852-201/107-030)  
SFP module 30: 1310nm; 100Base-FX Single-Mode LC; 30 km; silver-colored

**power supply**

 **Item no.: 787-1602** [www.wago.com/787-1602](http://www.wago.com/787-1602)  
Switched-mode power supply; Classic; 1-phase; 24 VDC output voltage; 1 A output current; NEC Class 2; DC OK signal

 **Item no.: 787-1606** [www.wago.com/787-1606](http://www.wago.com/787-1606)  
Switched-mode power supply; Classic; 1-phase; 24 VDC output voltage; 2 A output current; NEC Class 2; DC OK signal

 **Item no.: 787-1622** [www.wago.com/787-1622](http://www.wago.com/787-1622)  
Switched-mode power supply; Classic; 1-phase; 24 VDC output voltage; 5 A output current; TopBoost; DC OK contact

 **Item no.: 787-1623** [www.wago.com/787-1623](http://www.wago.com/787-1623)  
Switched-mode power supply; Classic; 1-phase; 48 VDC output voltage; 2 A output current; DC OK signal

 **Item no.: 787-1632** [www.wago.com/787-1632](http://www.wago.com/787-1632)  
Switched-mode power supply; Classic; 1-phase; 24 VDC output voltage; 10 A output current; TopBoost; DC OK contact

 **Item no.: 787-1633** [www.wago.com/787-1633](http://www.wago.com/787-1633)  
Switched-mode power supply; Classic; 1-phase; 48 VDC output voltage; 5 A output current; TopBoost; DC OK contact

 **Item no.: 787-1635** [www.wago.com/787-1635](http://www.wago.com/787-1635)  
Switched-mode power supply; Classic; 1-phase; 48 VDC output voltage; 10 A output current; TopBoost; DC OK contact













**transfer module**

 **Item no.: 289-195** [www.wago.com/289-195](http://www.wago.com/289-195)  
Interface module; RJ-45; IDC technology; Cat. 6; in mounting carrier; with shield connection

**wiring and connectors**

 **Item no.: 750-976** [www.wago.com/750-976](http://www.wago.com/750-976)  
PROFINET RJ-45 connector, IP20; ETHERNET 10/100 Mbit/s; for field assembly

Subject to changes. Please also observe the further product documentation!

	<b>Item no.: 750-977/000-011</b> Connector ETHERNET; RJ-45; Cat. 6A; straight; Code T568A; AWG 22	<a href="http://www.wago.com/750-977/000-011">www.wago.com/750-977/000-011</a>
	<b>Item no.: 750-977/000-012</b> Connector ETHERNET; RJ-45; Cat. 6A; straight; Code T568B; AWG 22	<a href="http://www.wago.com/750-977/000-012">www.wago.com/750-977/000-012</a>
	<b>Item no.: 750-977/000-013</b> Connector PROFINET; RJ-45; Cat. 6A; straight; AWG 22	<a href="http://www.wago.com/750-977/000-013">www.wago.com/750-977/000-013</a>
	<b>Item no.: 750-977/000-021</b> Connector ETHERNET; RJ-45; Cat. 6A; straight; Code T568A; AWG 24	<a href="http://www.wago.com/750-977/000-021">www.wago.com/750-977/000-021</a>
	<b>Item no.: 750-977/000-022</b> Connector ETHERNET; RJ-45; Cat. 6A; straight; Code T568B; AWG 24	<a href="http://www.wago.com/750-977/000-022">www.wago.com/750-977/000-022</a>
	<b>Item no.: 750-978/000-011</b> Connector ETHERNET; RJ-45; Cat. 6A; straight; Code T568A; AWG 22; Strain relief	<a href="http://www.wago.com/750-978/000-011">www.wago.com/750-978/000-011</a>
	<b>Item no.: 750-978/000-012</b> Connector ETHERNET; RJ-45; Cat. 6A; straight; Code T568B; AWG 22; Strain relief	<a href="http://www.wago.com/750-978/000-012">www.wago.com/750-978/000-012</a>
	<b>Item no.: 750-978/000-013</b> Connector PROFINET; RJ-45; Cat. 6A; straight; AWG 22; Strain relief	<a href="http://www.wago.com/750-978/000-013">www.wago.com/750-978/000-013</a>
	<b>Item no.: 750-978/000-021</b> Connector ETHERNET; RJ-45; Cat. 6A; straight; Code T568A; AWG 24; Strain relief	<a href="http://www.wago.com/750-978/000-021">www.wago.com/750-978/000-021</a>
	<b>Item no.: 750-978/000-022</b> Connector ETHERNET; RJ-45; Cat. 6A; straight; Code T568B; AWG 24; Strain relief	<a href="http://www.wago.com/750-978/000-022">www.wago.com/750-978/000-022</a>
	<b>Item no.: 750-979/000-011</b> Connector ETHERNET; RJ-45; Cat. 6A; angled; Code T568A; AWG 22; Strain relief	<a href="http://www.wago.com/750-979/000-011">www.wago.com/750-979/000-011</a>
	<b>Item no.: 750-979/000-012</b> Connector ETHERNET; RJ-45; Cat. 6A; angled; Code T568B; AWG 22; Strain relief	<a href="http://www.wago.com/750-979/000-012">www.wago.com/750-979/000-012</a>
	<b>Item no.: 750-979/000-013</b> Connector PROFINET; RJ-45; Cat. 6A; angled; AWG 22; Strain relief	<a href="http://www.wago.com/750-979/000-013">www.wago.com/750-979/000-013</a>

Subject to changes. Please also observe the further product documentation!



Item no.: 750-979/000-021  
Connector ETHERNET; RJ-45; Cat. 6A; angled; Code T568A; AWG 24; Strain relief

[www.wago.com/750-979/000-021](http://www.wago.com/750-979/000-021)



Item no.: 750-979/000-022  
Connector ETHERNET; RJ-45; Cat. 6A; angled; Code T568B; AWG 24; Strain relief

[www.wago.com/750-979/000-022](http://www.wago.com/750-979/000-022)

## Downloads

### Documentation

#### Manual

Managed Switch; MAC Security	V 1.0.0 28-May-2020	pdf 3.2 MB	Download
------------------------------	------------------------	---------------	----------

#### Bid Text

xml 7.4 kB	Download
---------------	----------

docx 17.6 kB	Download
-----------------	----------

#### Additional Information

Disposal; Electrical and electronic equipment, Packaging	V 1.0.0	pdf 265.8 kB	Download
--	---------	-----------------	----------

#### System Description

Industrial Switches – General Product Information		pdf 2.0 MB	Download
---	--	---------------	----------

## Installation Notes

Subject to changes. Please also observe the further product documentation!