

# General Purpose Relays

Types K, R, N, and C

Catalog

8501CT0301R7/08

2008

Class 8501



## CONTENTS

Description .....	Page
Type R – Miniature Plug-in Relays .....	3–6
Type K – Plug-in Relays .....	7–8
Type KA – Alternating Relays .....	9–10
Type N – Sockets and Accessories .....	11–13
Type C – Power Relays .....	15



by Schneider Electric

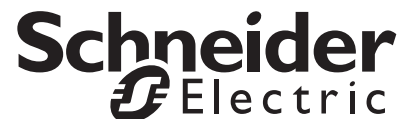



# Type R – Miniature Plug-in Relay General and Order Information

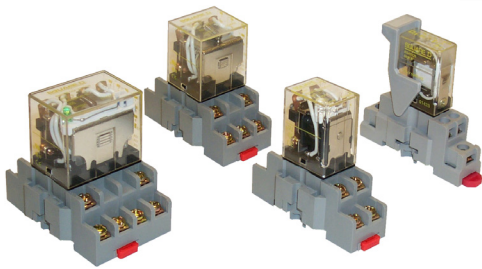

These miniature plug-in relays have a 10 Ampere resistive rating (except for RS/RSD41), the same as the Type K plug-in relays, but are much smaller. The compact size of these relays makes them ideal for downsizing equipment.

- SPDT through 4PDT
- AC or DC Operated
- Horsepower rated
- Complete line of Sockets
- Manual Operator / Bidirectional Green LED Pilot Light Options

### UL Contact Ratings

Type	Voltage	Resistive Rating	General Use Rating	Horsepower Rating
8501RS41 ◊	120 VAC	15	10	1/3
	240 VAC	12	10	1/2
8501RSD41 ◊	28 VDC	15	15	—
	120 VAC	10	10	1/3
8501RS42	240 VAC	10	10	1/2
	30 VDC	10	10	—
8501RSD42	120 VAC	10	10	—
8501RS43	250 VAC	10	10	—
	28 VDC	10	10	—
8501RSD43	120 VAC	10	10	—
8501RS44	250 VAC	10	10	—
	28 VDC	10	10	—

◊ RS41 and RSD41 relays have a B300 rating.

### Stocked Relays

Type	AC Voltage 50/60 Hz					Type	DC Voltage			
	6	12	24	120	240		6	12	24	110
Voltage Code	V35	V36	V14	V20	V24	Voltage Code	V50	V51	V53	V60
RS41			S	S		RSD41		S	S	
RS41M1			S	S		RSD41M1			S	
RS41P14			S	S		RSD41P14			S	
RS41M1P14			S	S		RSD41M1P14			S	
RS42	S	S	S	S	S	RSD42		S	S	S
RS42M1						RSD42M1				
RS42P14			S	S	S	RSD42P14	S	S	S	S
RS42M1P14				S		RSD42M1P14			S	
RS43			S	S		RSD43			S	
RS43M1						RSD43M1				
RS43P14				S		RSD43P14				
RS43M1P14				S		RSD43M1P14				
RS44			S	S	S	RSD44		S	S	
RS44M1						RSD44M1				
RS44P14				S		RSD44P14			S	
RS44M1P14				S		RSD44M1P14				

S – Stocked

Factory Order items require a **minimum** order quantity of 25 and have a lead time of 12 weeks.

	Input Voltage	Options	Type
 Silver Cadmium Oxide Contacts	AC 50/60 Hz	None	RS41*
		Manual Operator	RS41M1*
		Pilot Light	RS41P14*
		Manual Operator and Pilot Light	RS41M1P14*
	DC	None	RSD41*
		Manual Operator	RSD41M1*
		Pilot Light	RSD41P14*
		Manual Operator and Pilot Light	RSD41M1P14*

	Input Voltage	Options	Type
 Silver Cadmium Oxide Contacts	AC 50/60 Hz	None	RS42*
		Manual Operator	RS42M1*
		Pilot Light	RS42P14*
		Manual Operator and Pilot Light	RS42M1P14*
	DC	None	RSD42*
		Manual Operator	RSD42M1*
		Pilot Light	RSD42P14*
		Manual Operator and Pilot Light	RSD42M1P14*

	Input Voltage	Options	Type
 Silver Cadmium Oxide Contacts	AC 50/60 Hz	None	RS43*
		Manual Operator	RS43M1*
		Pilot Light	RS43P14*
		Manual Operator and Pilot Light	RS43M1P14*
	DC	None	RSD43*
		Manual Operator	RSD43M1*
		Pilot Light	RSD43P14*
		Manual Operator and Pilot Light	RSD43M1P14*

	Input Voltage	Options	Type
 Silver Cadmium Oxide Contacts	AC 50/60 Hz	None	RS44*
		Manual Operator	RS44M1*
		Pilot Light	RS44P14*
		Manual Operator and Pilot Light	RS44M1P14*
	DC	None	RSD44*
		Manual Operator	RSD44M1*
		Pilot Light	RSD44P14*
		Manual Operator and Pilot Light	RSD44M1P14*

\* Voltage code must be specified to order this product. Refer to standard voltage codes listed in the Stocked Relay table to the left and insert as shown in How To Order.

### How to Order:

To Order Specify:	Catalog Number		
<ul style="list-style-type: none"> <li>• Class Number</li> <li>• Type Number</li> <li>• Voltage Code</li> </ul> (See Stocked Relay Table to left)	Class	Type	Voltage Code
	8501	RS42	V20

Application Data ..... page 5  
Wiring Diagrams ..... page 6  
Dimensions ..... page 6

# Type R – Miniature Plug-in Relay

## General and Order Information

8501 R relays are suited for use as logic elements and power switching output devices. The short stroke motion of the armature provides long mechanical life required for high speed operation of control systems. Different contact compositions allow these relays to be used in a variety of applications. Fine silver (gold flashed) and bifurcated crossbar (gold overlay silver) are suitable for high contact reliability and low level switching requirements. Silver cadmium oxide is best suited for inductive loads. Hermetically sealed relays can be used in adverse environments.

- 1, 3, or 5 Ampere Versions
- 4PDT
- Complete Socket Line
- Horsepower Rated
- AC or DC Operation
- Manual Operator/ Pilot Light Options

5 A	Input Voltage	Options	Type
For switching inductive loads  Contacts: Silver Cadmium Oxide	AC 50/60 Hz	None	RS14*
		Manual Operator	RS14M1*
		Pilot Light	RS14P14*
		Manual Operator and Pilot Light	RS14M1P14*
	DC	None	RSD14*
		Manual Operator	RSD14M1*
		Pilot Light	RSD14P14*
		Manual Operator and Pilot Light	RSD14M1P14*

3 A	Input Voltage	Options	Type
For low level switching  Contacts: Fine Silver (Gold Flashed)	AC 50/60 Hz	None	RS4*
		Manual Operator	RS4M1*
		Pilot Light	RS4P14*
		Manual Operator and Pilot Light	RS4M1P14*
	DC	None	RSD4*
		Manual Operator	RSD4M1*
		Pilot Light	RSD4P14*
		Manual Operator and Pilot Light	RSD4M1P14*

1 A	Input Voltage	Type
Best for low level switching Bifurcated Silver Gold Plated Contacts	AC 50/60 Hz	RS24*
	DC	RSD24*

Hermetically Sealed	Input Voltage	Type
5 Ampere Resistive <sup>▲</sup> Silver Cadmium Oxide Contacts Suitable for Class I Division 2 Locations	AC 50/60 Hz	RS34*
	DC	RSD34*

\* Voltage code must be specified to order this product. Refer to standard voltage codes listed in the Stocked Relays table on page 5 and insert as shown in How To Order.

▲ Do not ground frame.

8501 RS4V14



### Pilot Light Option

An Internal green **pilot light** is available in both AC and DC versions for positive indication of power to the coil. The pilot lights are bidirectional LEDs.

8501 RSD14P14V53



### Manual Operation Option

To speed circuit testing, a manual operator can be provided. The relay can be manually switched to simulate normal operation.

NOTE: All Type R relays with a manual operator must be used on circuits of same polarity.

8501 RS14M1V14



### Contact Ratings

Type	Voltage	Continuous Current Rating	Horsepower Rating
RS4 <sup>◇</sup>	120/240 VAC	3	1/10
RSD4 <sup>◇</sup>	30 VDC	3	–
RS14 <sup>◇</sup>	120/240 VAC	5	1/6
RSD14 <sup>◇</sup>	30 VDC	5	–
RS24	120/240 VAC	1	1/16 <sup>*</sup>
RSD24	30 VDC	1	–
RS34	120/240 VAC	5	–
RSD34	30 VDC	5	–

<sup>◇</sup> RS4/RSD4, RS14/RSD14 have C300 pilot duty rating.

<sup>\*</sup> Horsepower rating at 120 VAC.

### How to Order:

To Order Specify:	Catalog Number		
<ul style="list-style-type: none"> <li>• Class Number</li> <li>• Type Number</li> <li>• Voltage Code</li> </ul> (See Stocked Relay Table on page 5)	Class	Type	Voltage Code
	8501	RS4	V20

Application Data ..... page 5  
 Wiring Diagrams ..... page 6  
 Dimensions ..... page 6  
 Sockets and Holddown Clips ..... page 14

## Type R – Miniature Plug-in Relay Ordering Information and Application Data





### Stocked Relays

Type	AC Voltage 50/60 Hz						Type	DC Voltage				
	6	12	24	48	120	240		6	12	24	48	110
Voltage Code	V35	V36	V14	V17	V20	V24	Voltage Code	V50	V51	V53	V56	V60
RS4			S		S		RSD4		S	S		
RS4M1					S		RSD4M1					
RS4P14					S		RSD4P14			S		
RS4M1P14					S		RSD4M1P14			S		
RS14		S	S		S		RSD14		S	S		S
RS14M1					S		RSD14M1			S		
RS14P14					S		RSD14P14		S	S		S
RS14M1P14					S	S	RSD14M1P14		S	S		
RS24					S		RSD24			S		
RS34					S		RSD34		S	S		

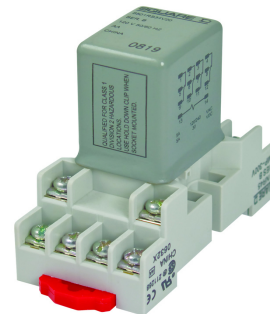
S – Stocked

– Factory Order items require a **minimum** order quantity of 25 and have a lead time of 12 weeks.



Class 8501 Type		RS4	RSD4	RS14	RSD14	RS24	RSD24	RS34	RSD34	RS41	RSD41	RS42	RSD42	RS43	RSD43	RS44	RSD44	
Operating Data	Pick-Up Time	25 ms Maximum						13 ms Max.			20 ms Maximum							
	Drop-Out Time	25 ms Maximum						6 ms Max.			20 ms Maximum							
	Operating Temperature Range	-40° C to +70° C (-40° F to +158° F)						-45° C to +70° C (-49° F to +158° F)			-40° C to +70° C (-40° F to +158° F)							
Coil	Duty Cycle	Continuous																
	Voltage Range	AC coils +10%, -15% of nominal DC coils +10%, -20% of nominal																
	AC Coils	1.2 VA sealed	–	1.2 VA sealed	–	1.2 VA sealed	–	1.2 VA sealed	–	1.5 VA inrush, 1.1 VA sealed	–	2.2 VA inrush, 1.3 VA sealed	–	2.9 VA inrush, 2.0 VA sealed	–	3.7 VA inrush, 2.6 VA sealed	–	
	DC Coils	–	0.9 watt	–	0.9 watt	–	0.9 watt	–	0.9 watt	–	0.7 watt	–	0.9 watt	–	1.0 watt	–	1.0 watt	
	File CCN	E197072 NRNT2						N/A			E78351 NLDX2		E78427 NRNT2					
	File CCN	E197072 NRNT8 (Approved but not marked)						E196809 NQMJ2, NQMJ8			N/A							
	File Class	211268 3211 07						N/A			211268 3211 07							
		Yes																
	File CCN	E78351 * NLDX						E123950 * NPKR, NPKR7			E78351 * NLDX			N/A				

\* When used with the appropriate 8501 NR socket.

# Type R – Miniature Plug-in Relay

## Dimensions and Wiring Diagram

### Wiring Diagrams

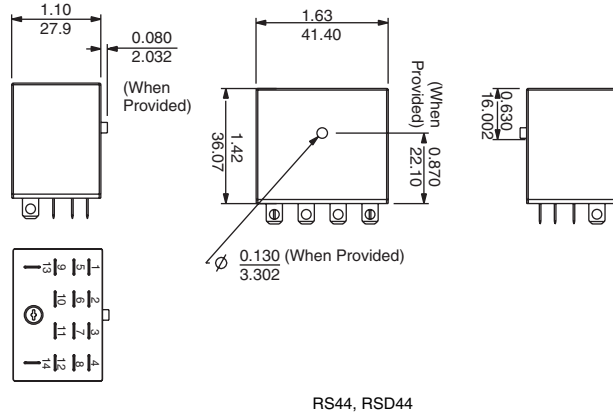
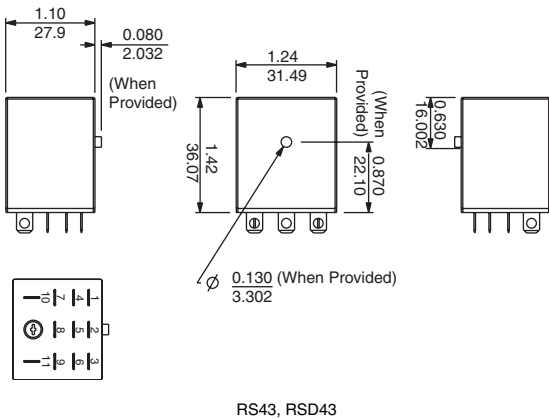
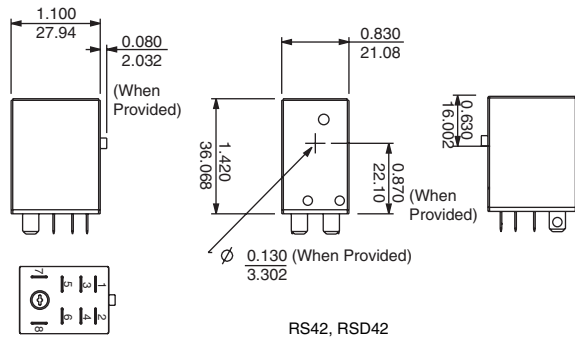
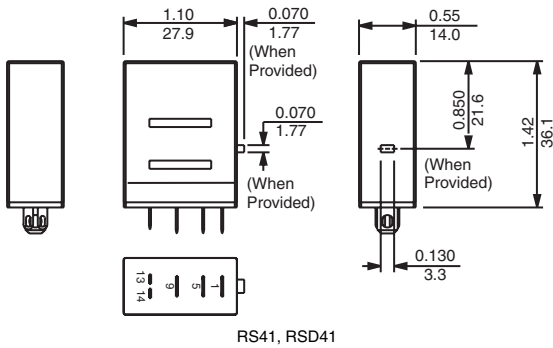
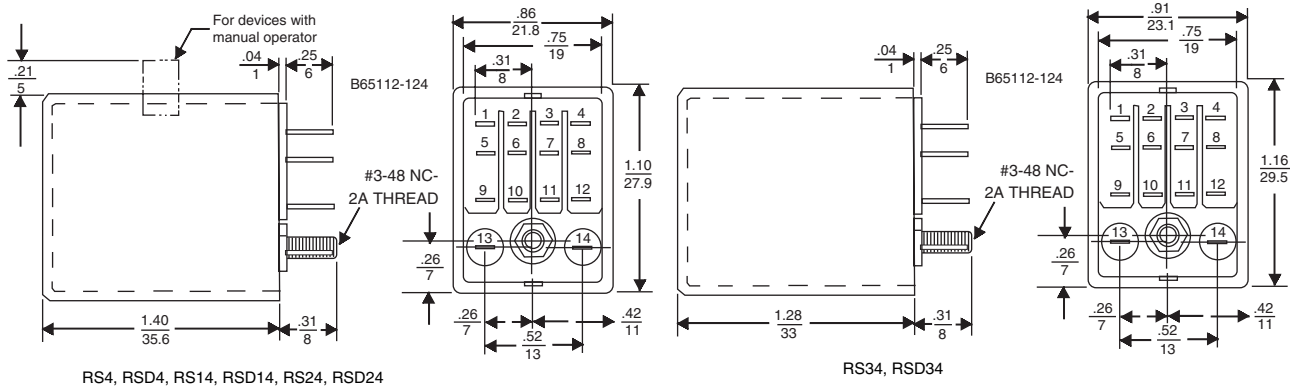
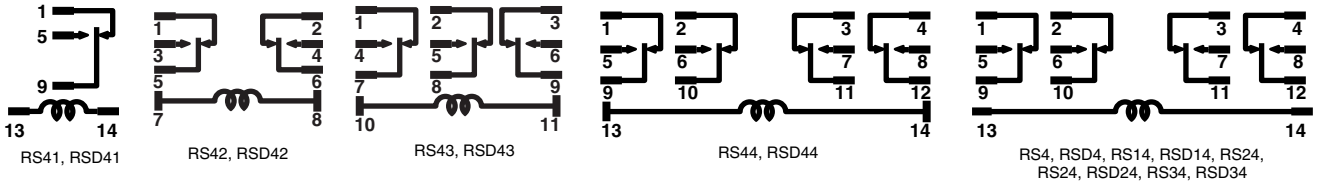

Dual Dimensions: Inches  
Millimeters

# Type K - Plug-in Relay Dimensions and Wiring Diagram

8501 K relays are designed for multipole switching applications at 240 volts or lower. These relays have industry standard wiring and pin arrangements which allows for their use as replacements for many similar relays without wiring or hardware modifications.

- 10 or 15 Ampere Versions
- DPDT or 3PDT
- Manual Operator/  
Red Pilot Light Options
- Horsepower Rated
- DPDT Latching Relay
- AC or DC Operation

### Type KF – Flange Mounted – Spade Terminals

	Input Voltage	Contact Arrangement	Options	Type
	AC 50/60 Hz	DPDT	None Available	KF12*
		3PDT		KF13*
	DC	DPDT	None Available	KFD12*
		3PDT		KFD13*

\* Socket is not required with Type KF relays.

### Type KL – Latching Relay – Spade Terminals

	Input Voltage	Contact Arrangement	Options	Type
	AC 50/60 Hz	DPDT	None Available	KL12*
	DC	DPDT	None Available	KLD12*

### Stocked Relays

Type	AC Voltage 50/60 Hz					Type	DC Voltage					
	6	12	24	120	240		6	12	24	48	110	125
Voltage Codes	V35	V36	V14	V20	V24	Voltage Codes	V50	V51	V53	V56	V60	V63
KP12	S	S	S	S	S	KPD12	S	S	S	S	S	S
KP12P14		S	S	S	S	KPD12P14		S	S	S	S	S
KP13		S	S	S	S	KPD13		S	S	S	S	S
KP13P14			S	S	S	KPD13P14			S			S
KU12		S	S	S	S	KUD12		S	S			
KU12M1						KUD12M1			S			
KU12P14			S	S		KUD12P14						
KU12M1P14			S	S	S	KUD12M1P14			S			
KU13		S	S	S	S	KUD13		S	S	S	S	
KU13M1						KUD13M1			S			
KU13P14			S	S		KUD13P14						
KU13M1P14			S	S	S	KUD13M1P14			S		S	S
KF12			S	S	S	KFD12			S	S		
KF13			S	S		KFD13			S			
KL12			S	S	S	KLD12		S	S			

S – Stocked

– Factory Order items require a **minimum** order quantity of 25 and have a lead time of 12 weeks.

\* Voltage code must be specified to order this product. Refer to standard voltage codes listed in the Stocked Relays table above and insert as shown in How To Order.

### How to Order:

To Order Specify:	Catalog Number		
<ul style="list-style-type: none"> <li>• Class Number</li> <li>• Type Number</li> <li>• Voltage Code</li> </ul> (See Stocked Relay Table above)	Class	Type	Voltage Code
	8501	KP12	V20

### Type KP – Tubular Terminals

	Input Voltage	Contact Arrangement	Options	Type
	AC 50/60 Hz	DPDT	None	KP12*
		DPDT	Pilot Light	KP12P14*
		3PDT	None	KP13*
	DC	3PDT	Pilot Light	KP13P14*
		DPDT	None	KPD12*
		DPDT	Pilot Light	KPD12P14*
		3PDT	None	KPD13*
		3PDT	Pilot Light	KPD13P14*

### Type KU – Spade Terminals

	Input Voltage	Contact Arrangement	Options	Type
	AC 50/60 Hz	DPDT	None	KU12*
		DPDT	Manual Operator	KU12M1*
		DPDT	Pilot Light	KU12P14*
		DPDT	Manual Operator and Pilot Light	KU12M1P14*
		3PDT	None	KU13*
		3PDT	Manual Operator	KU13M1*
		3PDT	Pilot Light	KU13P14*
		3PDT	Manual Operator and Pilot Light	KU13M1P14*
	DC	DPDT	None	KUD12*
		DPDT	Manual Operator	KUD12M1*
		DPDT	Pilot Light	KUD12P14*
		DPDT	Manual Operator and Pilot Light	KUD12M1P14*
		3PDT	None	KUD13*
		3PDT	Manual Operator	KUD13M1*
		3PDT	Pilot Light	KUD13P14*
		3PDT	Manual Operator and Pilot Light	KUD13M1P14*

**Pilot Light Option** – Available on Types KP and KU. Internal pilot lights are available in both ac and dc versions for positive indication of power to the coil. The pilot light will be a red bidirectional LED.

**Manual Operator Option** – Available on Type KU only. To speed circuit testing a manual operator can be provided. With this feature the relay can be manually switched to simulate normal operation.

Application Data .....	page 8
Dimensions .....	page 8
Sockets .....	page 14

# Type K — Plug-in Relay

## Application Data, Dimensions, Wiring Diagrams

### Contact Ratings

Type	AC			DC	
	AC Volts	Resistive 75% PF Continuous Amperes	HP	DC Volts	Resistive Amperes
KP <sup>a</sup>	120	10	1/3	28	10
	240	10 <sup>b</sup>	1/2		
KU <sup>a</sup> KF <sup>a</sup>	120	15 <sup>a</sup>	1/3	28	10
	240	10 <sup>b</sup>	1/2		
KL	120	10	1/3	28	10
	240	10	1/2		

<sup>a</sup> 8501 KP, KU, and KF relays have a B300 rating.

<sup>b</sup> 3 pole devices have a 20 A max. total (sum of currents in all 3 poles), continuous rating.

<sup>a</sup> 3 pole devices have a 30 A max. total (sum of currents in all 3 poles), continuous rating.

### Operating Data

	Type	Comments
Typical Pick-Up Time	KP	AC coil: approximately 12 ms DC coil: approximately 18 ms
	KF, KU	AC coil: approximately 8 ms DC coil: approximately 11 ms
	KL	approximately 25 ms
Typical Drop-Out Time	KP	AC coil: approximately 12 ms DC coil: approximately 7 ms
	KF, KU	AC coil: approximately 8 ms DC coil: approximately 7 ms
	KL	approximately 25 ms
Operating Temperature Range	KF, KP, KU	AC: 2 pole: -40°C to +55°C (-40°F to +131°F) 3 pole: -40°C to +45°C (-40°F to +113°F) DC: -40°C to +70°C (-40°F to +158°F)
	KL	AC/DC: -45°C to +70°C (-49°F to +158°F)

### Contacts

Configuration	2PDT or 3PDT (2 or 3 Form C)
Ratings	See contact ratings table above.
Material	KF, KU, and KL—Silver cadmium oxide KP—Silver nickel

### Coils

Duty	Continuous rated coils	
Available Voltages	See Stocked Relays page 7.	
Operate	AC: +10, -15% of Nominal Voltage at 25°C (77°F) DC: +10, -25% of Nominal Voltage at 25°C (77°F)	
Typical Burden	Types KP, KU, KF	AC: 3.6 VA inrush, 2.5 VA sealed DC: 1.5 watts standard, 3 watts maximum
	Type KL	AC: 2.0 VA latch, 0.8 VA unlatch DC: 1.2 watts

### General

Terminals: Solder/plug-in

UL/CSA:

For 8501 KP, KU, and KF:



File CCN E197072  
NRNT2



File Class 212845  
3211 07



For 8501 KP, KU, and KL:



File CCN E78351  
NLDX

When used with the appropriate 8501NR socket.

### Wiring Diagrams

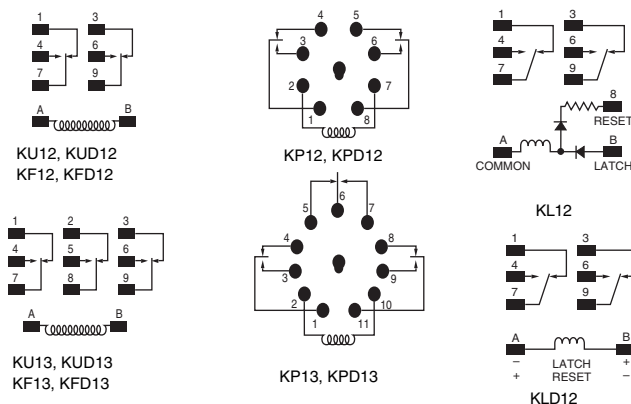

### Approximate Dimensions

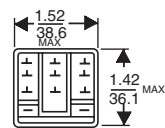
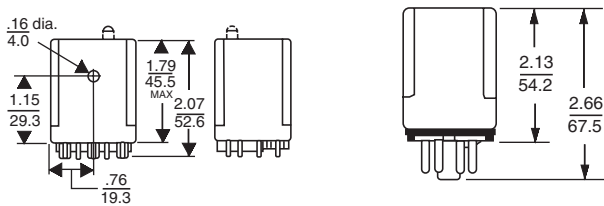

Type KU

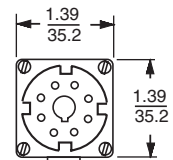
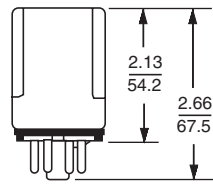

Type KP

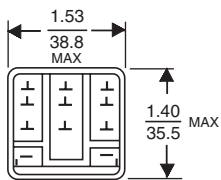
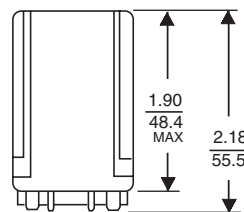

Type KL

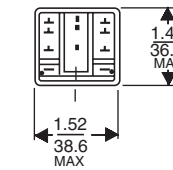
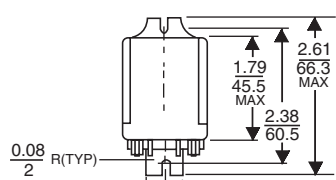

Type KF

Dual Dimensions: Inches  
Millimeters

For 8501 KL:



File CCN E78351  
NLDX2



File Class 211269  
3211 04





# Type KA – Alternating Relays General Information and Specifications

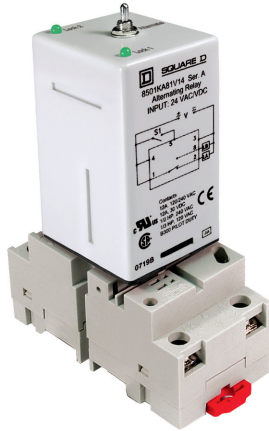

8501 KA alternating relays are designed to minimize pump and motor wear by equalizing run time between parallel components in a multi-pump system. These relays are controlled by an external control switch. This switch may be any type of contact closure; for example, the contacts of a timing relay or the closure of a float switch. The 8501 KA relays also have a toggle switch that allows the operator to lock one side of the duplex system, preventing alternation.

- 12 A Resistive Rating
- SPDT or DPDT
- Toggle switch for load control
- LED Load Indicators
- Horsepower Rated
- AC and DC Control
- UL Listed w/ SquareD Socket
- Rohs Compliant

## Type KA – Alternating Relay

	Input Voltage	Contact Arrangement	Options	Type
	AC & DC	SPDT	LED, Toggle	8501KA81
	AC & DC	DPDT	LED, Toggle, Duplex Pumping	8501KA82
	AC & DC	DPDT (N.C.)	LED, Toggle	8501KA112
	AC & DC	DPDT (N.O.)	LED, Toggle	8501KA112A

## Contact Ratings

Type	AC				DC	
	AC Volts	Resistive Amperes	HP	Pilot Duty	DC Volts	Resistive Amperes
8501KA***	120	12	1/3	B300	30	12
	240	12	1/2	B300		

## Relay Availability

Type	AC & DC Voltage			AC Voltage
	12	24	120	240
Voltage Code	V36	V14	V20	V24
8501KA***		S	S	
8501KA***		S	S	
8501KA***		S	S	
8501KA***		S	S	

AC Voltage = 50/60 Hz

S – Stocked. Stocked items do not require a minimum quantity and have a lead time of 2 weeks.

All other part numbers require a minimum order quantity of 100 and have a lead time of 18 weeks.

## Alternating Functions

Diagram	Toggle Switch Position	Detail	S1 = Control Switch 1	S2 = Control Switch 2	LA = Load 1	LB = Load 2
A, C & D	Alternate		Closing S1 alternates the loads between LA and LB.			
	Lock 1		LA is ON and LB is OFF. S1 is not used in this mode.			
	Lock 2		LA is OFF and LB is ON. S1 is not used in this mode.			
B	Alternate		Closing S1 alternates the loads between LA and LB. S2 will only control LA.			
	Lock 1		S1 will control LA and S2 will control LB.			
	Lock 2		S1 will control LB and S2 will control LA.			
The cross wired option allows extra system load capacity through simultaneous operation of both motors when needed (LA and LB energize simultaneously when both S1 and S2 are closed - relay contacts are not isolated).						
All	Input voltage must be applied at all times for proper alternation. Use of a solid state control switch for S1 or S2 may not initiate alternation correctly. S1 or S2 voltage must be from the same supply as the unit's input voltage (see wiring diagrams). Loss of input voltage resets the unit; LA becomes the lead load for the next operation.					

# Type KA – Alternating Relays

## Wiring Diagrams and Approximate Dimensions

### Wiring Diagrams

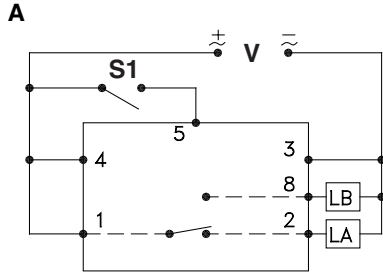

**8501KA81\*\*\***  
Socket = 8501NR51 or NR52

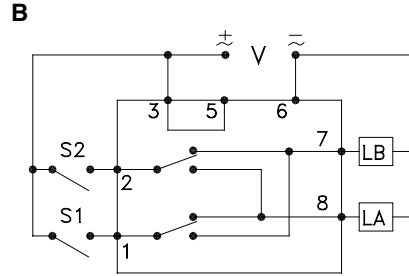

**8501KA82\*\*\***  
Socket = 8501NR51 or NR52

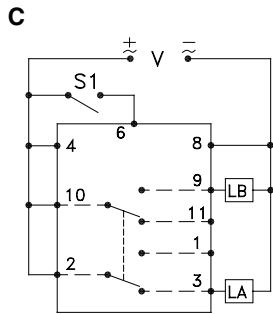

**8501KA112\*\*\***  
Socket = 8501NR61 or NR62

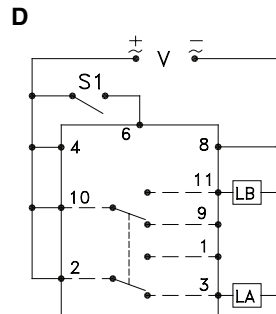

**8501KA112A\*\*\***  
Socket = 8501NR61 or NR62

### Approximate Dimensions

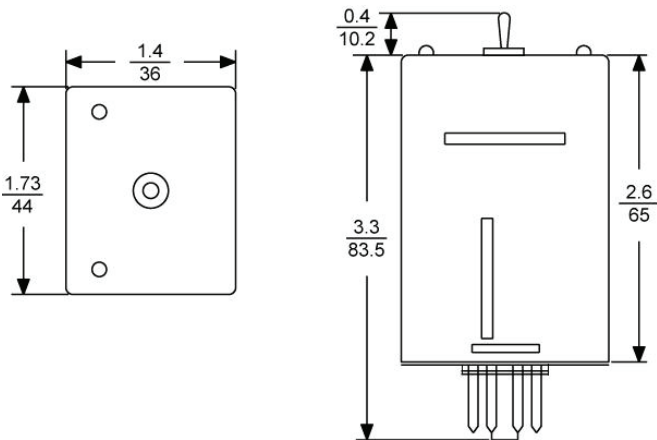

FILE CLASS

E78351  
NLDX2



FILE CLASS

242675  
3211 07



## Type N – Sockets and Accessories General and Order Information

8501 NR sockets are designed for use with plug-in 8501 K and Type R relays, 8430 MPS phase failure relays and 9050 JCK timers. The 8501 NR45 screw terminal sockets have pressure wire clamps that accept 1 or 2 #16-22 wires. All other sockets have pressure clamps that will accept 1 or 2 #12-22 wires.

The recommended tightening torque for all terminals is 7-8 lb-in.

- All Devices Stocked in Central Warehouse
- DIN Track Mount or Direct Panel Mount
- Tubular Sockets Available in Easy-to-Wire Single Tier or Space-Saving Multi-Tier Versions

### Snapmount Sockets

For Use With			Description	Socket Rating		Class 8501 Type	Std. Qty.*
Class 8501 Type	Class 8430 Type	Class 9050 Type		UL	CSA		
KP12 KPD12	MPS (240 volts)	JCK11 – 19 JCK31 – 39 JCK51 – 59 JCK60 JCK1 F JCK3 F JCK5 F	8 Pin Tubular Single Tier Screw Terminal	10 A 600 V 15 A 300 V	10 A 300 V	NR51 NR51B	1 10
			8 Pin Tubular Double Tier Screw Terminal	5 A 600 V 16 A 300 V	10 A 300 V	NR52 NR52B	1 10
KP13 KPD13	—	JCK21 – 29 JCK41 – 49 JCK70 JCK2F JCK4F	11 Pin Tubular Single Tier Screw Terminal	5 A 600 V 15 A 300 V	10 A 300 V <sup>▲</sup>	NR61 NR61B	1 10
			11 Pin Tubular Double Tier Screw Terminal	5 A 600 V 16 A 300 V	10 A 300 V <sup>▲</sup>	NR62 NR62B	1 10
KL KU	MPS (480 Volts)	—	11 Pin Spade Double Tier Screw Terminal	15 A 300 V <sup>†</sup>	—	NR82 NR82B	1 10
RS41 RSD41	—	—	5 Pin Spade Double Tier Screw Terminal	15 A 300 V <sup>†</sup>	—	NR41 NR41B	1 10
RS42 RSD42	—	—	8 Pin Spade Double Tier Screw Terminal	10 A 300 V	—	NR42 NR42B	1 10
RS43 RSD43	—	—	11 Pin Spade Double Tier Screw Terminal	10 A 300 V <sup>▲</sup>	—	NR43 NR43B	1 10
RS44 RSD44	—	—	14 Pin Spade Double Tier Screw Terminal	10 A 300 V <sup>▲</sup>	—	NR34 NR34B	1 10
RS4 RSD4 RS14 RSD14 RS24 RSD24 RS34 RSD34	—	—	14 Pin Spade Double Tier Screw Terminal	10 A 300 V	—	NR45 NR45B	1 10

\* Must be ordered in multiples of the quantity listed. Units provided in standard quantity of one are individually packaged; devices with B suffix have a standard quantity of 10 per bulk pack.  
<sup>†</sup> Rated for use with Class 8430 Type MPS at 480 Volts.  
<sup>▲</sup> 20 A maximum total load (CSA)

**NOTE:** For DIN 3 mounting track and end clamps refer to the NEMA type terminal block section 9080CT9601 or the IEC type terminal block section 9080CT9901R5/02.

### UL/CSA:

 File CCN	E66924 SW1V2	 File Class	LR84913 3211 07
--	-----------------	--	--------------------

### How to Order:

To Order Specify:	Catalog Number	
• Class Number	Class	Type
• Type Number	8501	NR51B

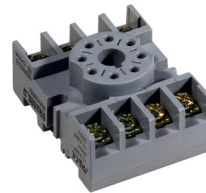

8501 NR51

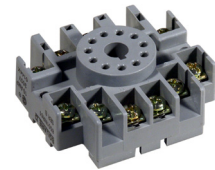

8501 NR61



8501 NR52



8501 NR62

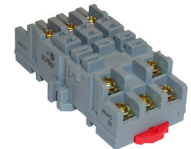

8501 NR82

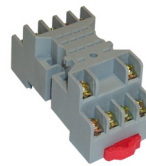

8501 NR45



8501 NR41



8501 NR42



8501 NH7



8501 NR43

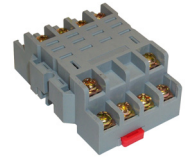

8501 NR34

### Socket Accessories

Socket	For Use With	Description	Catalog Number	Std. Pack*	
8501NR51	8501KP12, KPD12	Hold Down Clip	Not Available	—	
	8430MPSV24	Restraining Strap	8501NH7	1	
	9050JCK	Restraining Strap	8501NH7	1	
8501NR52	8501KP12, KPD12	Hold Down Clip	8501NH52	10	
	8430MPSV24	Restraining Strap	8501NH7	1	
	9050JCK	Restraining Strap	8501NH7	1	
8501NR61	8501KP13, KPD13	Hold Down Clip	Not Available	—	
	9050JCK	Restraining Strap	8501NH7	1	
	8501NR62	8501KP13, KPD13	Hold Down Clip	8501NH52	10
8501NR82	8501KU and KL	Hold Down Clip	8501NH82	10	
	8430MPSV29	Restraining Strap	8501NH7	1	
	8501NR41	8501RS41, RSD41	Hold Down Clip	Supplied with socket as standard	—
8501NR42		8501RS42, RSD42	Hold Down Clip	8501NH42	10
8501NR43		8501RS43, RSD43	Hold Down Clip	8501NH42	10
8501NR34	8501RS44, RSD44	Hold Down Clip	8501NH42	10	
8501NR45	8501RS4, RSD4 8501RS14, RSD14 8501RS24, RSD24 8501RS34, RSD34	Hold Down Clip	8501NH45	10	

Dimensions ..... page 12  
Terminal Locations ..... page 12

# Type N – Sockets and Accessories

## General and Order Information

**Type NR51**

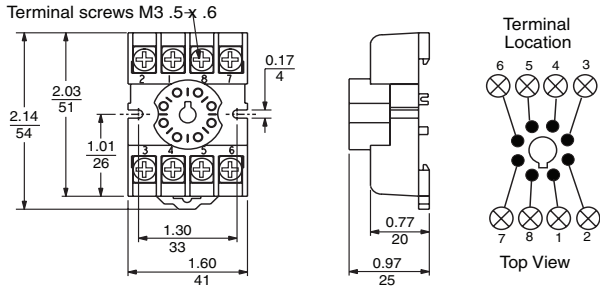

**Type NR52**

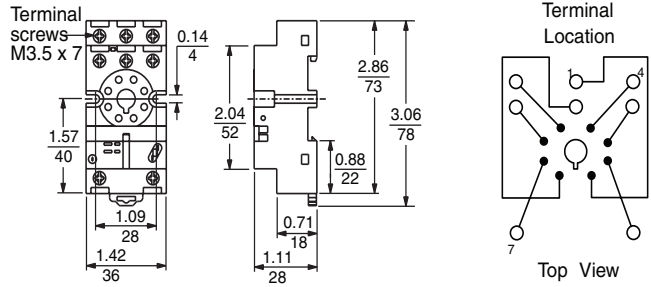

**Type NR61**

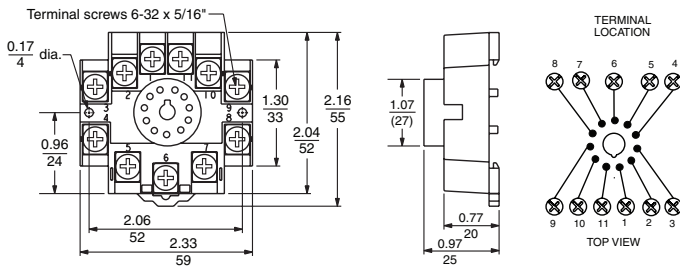

**Type NR62**

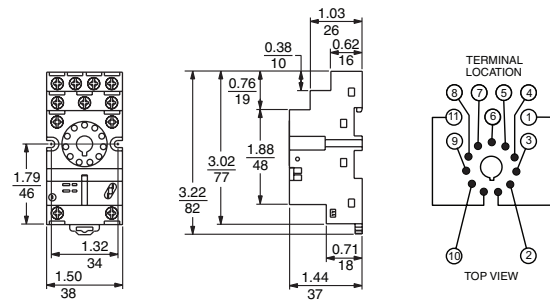

**Type NR82**

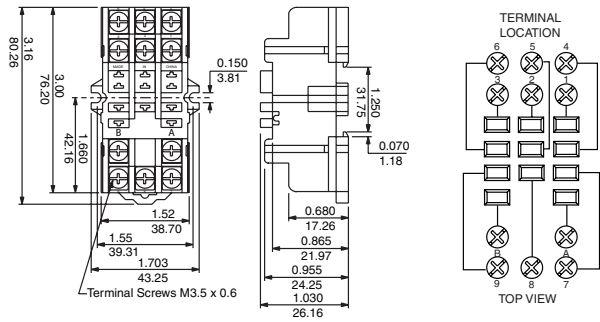

**Type NR45**

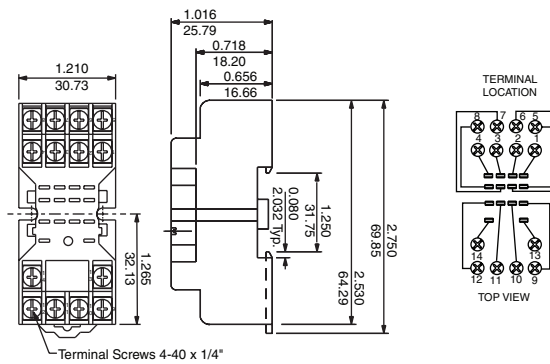

# Type N – Sockets and Accessories General and Order Information

**Type NR41**

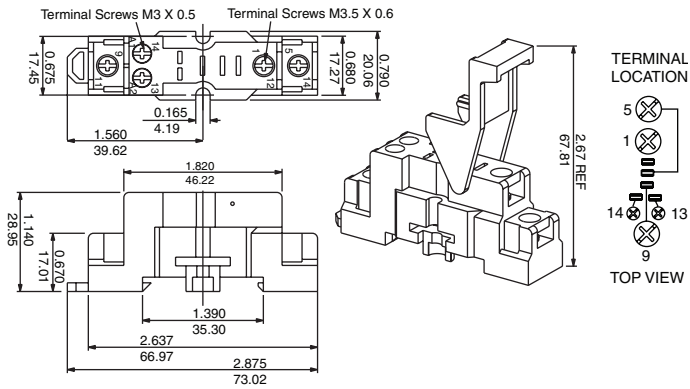

**Type NR42**

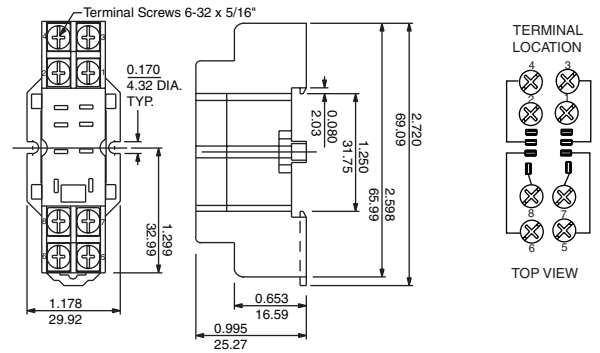

**Type NR43**

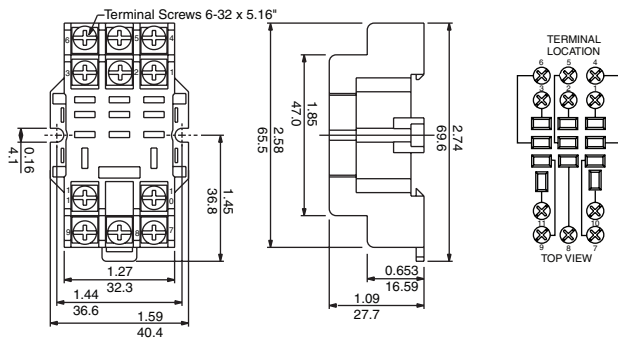

**Type NR34**

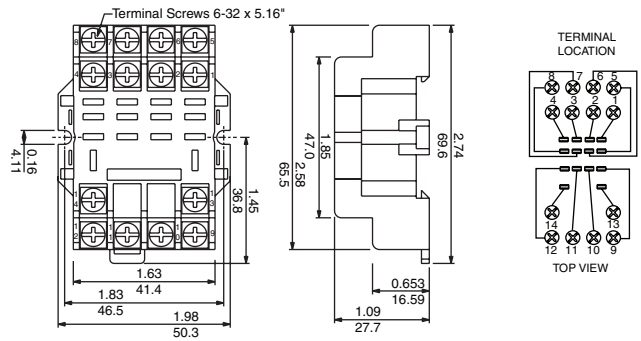

# Type C – Power Relays

## Application Data, Dimensions, Order Information

Class 8501 Type C relays are ideally suited for controlling small single phase motors and other light loads such as electric heaters, pilot lights or audible signals.

- 30 Ampere Contact Rating
- Horsepower Rated
- UL Listed
- CSA Certified
- CE Approved
- Visible Contacts
- Low Cost

8501CDO6V51



Selection Table— AC Rated Contacts					Application Data — AC Contact Ratings						Application Data — Coil Burden	
Contact Arrangement	Number of Fixed Contacts		AC Operated Coil Open Type	DC Operated Coil Open Type	Maximum Contact Voltage	Resistive Ampere Rating 75% Power Factor		Maximum Single Phase Horsepower			Nominal Power (VAC Coil)	Nominal DC Burden (VDC Coil)
	N.O.	N.C.	Type	Type		300V	600V	120V	230V	600V		
SPST	1	0	CO6*	CDO6*	600	30	10	2	2	2	10VA	2W
DPST	2	0	CO7*	CDO7*	600	30	5	1½	1½	1½	10VA	2W
SPST	0	1	CO8*	CDO8*	600	30	10	2	2	2	10VA	2W
SPDT	1	1	CO15*	CDO15*	600	30	5	1½	1½	1½	10VA	2W
DPDT	2	2	CO16*	CDO16*	600	30	5	1½	1½	1½	10VA	2W

Selection Table — DC Rated Contacts					Application Data — DC Contact Ratings			Application Data — Coil Burden		
Contact Arrangement	N.O.	N.C.	Type	Type	Maximum Contact Voltage	110V	220V	N.A.	Nominal Power (VAC Coil)	Nominal DC Burden (VDC Coil)
						SPST	1			
DPDT	2	2	CO22*	CDO22*	325	10	4	10VA	2W	

\* Voltage code must be specified to order this product. Refer to standard voltage codes listed in the Stocked Relays table below and insert as shown in How to Order.

### Enclosure:

Separately packed NEMA Type 1 sheet steel enclosure for Types CO & CDO relays – order Class 9991 Type UE1

### Operating Data

<b>Operating Voltages/ Voltage Range</b>	AC – 6 through 480 volts, + 10/-15% of nominal at 25°C DC – 6 through 110 volts, + 10/-20% of nominal at 25°C
<b>Coil Inrush (VAC Coil)</b>	15VA
<b>Coils</b>	Duty: Continuous rated coils. (Non-replaceable)
<b>Operating Temp. Range</b>	AC: -22°F to +122°F (-30°C to +50°C) DC: -22°F to +140°F (-30°C to +60°C)

### UL/CSA:



File CCN E78351  
NLDX



File Class 209683  
04 3211



### Approximate Dimensions

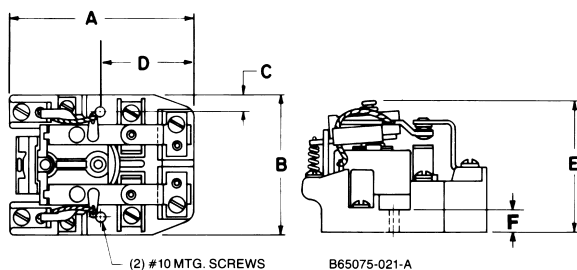

### Dimensions

Catalog Number 8501****	A		B		C		D		E		F	
	IN	mm	IN	mm	IN	mm	IN	mm	IN	mm	IN	mm
CO6, CO7, CO8, CDO6, CDO7, CDO8	2.43	61.7	2.50	63.5	0.31	8.0	0.81	20.6	2.25	57.2	0.38	9.5
CO15, CO21, CDO15, CDO21	2.43	61.7	2.50	63.5	0.31	8.0	0.81	20.6	2.18	55.4	0.38	9.5
CO16, CDO16	3.12	79.2	2.50	63.5	0.31	8.0	1.5	38.1	2.31	58.7	0.38	9.5
CO22, CDO22	3.12	79.2	2.50	63.5	0.31	8.0	1.5	38.1	2.53	64.3	0.38	9.5

### Stocked Relays

Class 8501 Type	AC Voltage – 50/60 Hz								Class 8501 Type	DC Voltage			
	6	12	24	120	208	240	277	480		6	12	24	110
Voltage Code	V35	V36	V14	V20	V08	V24	V04	V29	Voltage Code	V50	V51	V53	V60
CO6	S	S	S	S	S	S	S	S	CDO6	S	S	S	S
CO7	S	S	S	S	S	S	S	S	CDO7	S	S	S	S
CO8		S	S	S	S	S	S	S	CDO8		S	S	S
CO15	S	S	S	S	S	S	S	S	CDO15		S	S	S
CO16	S	S	S	S	S	S	S	S	CDO16		S	S	S
CO21			S						CDO21		S	S	S
CO22			S						CDO22		S	S	S

S – Stocked

Factory Order items require a **minimum** order quantity of 25 and have a lead time of 12 weeks.

### How to Order:

To Order Specify:	Catalog Number		
<ul style="list-style-type: none"> <li>• Class Number</li> <li>• Type Number</li> <li>• Voltage Code</li> </ul> (See Stocked Relay Table above)	Class	Type	Voltage Code
	8501	CO6	V20

**Type C – Power Relays**  
**Application Data, Dimensions, Order Information**

**Schneider Electric USA**

8001 Knightdale Blvd.  
Knightdale, NC 27545  
1-888-SquareD  
(1-888-778-2733)  
[www.schneider-electric.us](http://www.schneider-electric.us)

**Schneider Electric Canada**

19 Waterman Avenue,  
M4B 1 Y2  
Toronto, Ontario  
1-800-565-6699  
[www.schneider-electric.ca](http://www.schneider-electric.ca)

8501CT0301R7/08 © 2003-2008 Schneider Electric All Rights Reserved  
Replaces 8501CT0301, December 2003