

841CS2-UNI

Current sensor relay, Legacy, SPDT, 15A, 24 to 240 VAC, 1 time scale, 200 mA to 2 A, DIN mounting



Main

Product Range	Legacy
Product Type	Relay
Sensory Type	Current sensor
Switch Function	SPDT
Contacts Material	AgNi
Time Delay Type	Adjustable
Rated Supply Voltage	24...240 V AC 50...60 Hz

Complementary

Time Delay Range	0...10 s
Control Type	With adjustment knob front
Nominal Output Current	15 A
Local Signalling	1 LED red, blinking timing in progress 1 LED per input green
Repeat Accuracy	+/- 1 % - 5...5 %
Tripping Threshold	0.2...2 A
Reset Time	150 ms
Power Consumption in VA	1.5 VA 24...240 V
Rated Operational Current	15 A 240 V AC-1 15 A 24 V DC
Motor Power HP	1 hp 240 V AC
Minimum Switching Current	100 mA
Maximum Switching Voltage	12 V
Tightening Torque	7.08 lbf.in (0.8 N.m)
AWG Gauge	AWG 14
Electrical Durability	100000 cycles
Mechanical Durability	30000000 cycles
Mounting Support	35 mm DIN rail EN 55022
Height	2.52 in (64 mm)
Width	0.69 in (17.6 mm)
Depth	3.54 in (89.95 mm)
Product Weight	2.12 oz (60 g)

Environment

Dielectric Strength	4000 V between input and output
Standards	IEC 61810-1
Product Certifications	CULus
Ambient Air Temperature for Storage	-22...158 °F (-30...70 °C)
Ambient Air Temperature for Operation	-4...131 °F (-20...55 °C)
IP Degree of Protection	IP20 IEC 60529 enclosure)

The information provided in this documentation contains general descriptions and/or technical characteristics of the performance of the products contained herein. This documentation is not intended as a substitute for and is not to be used for determining suitability or reliability of these products for specific user applications. It is the duty of any such user or integrator to perform the appropriate and complete risk analysis, evaluation and testing of the products with respect to the relevant specific application or use thereof. Neither Schneider Electric Industries SAS nor any of its affiliates or subsidiaries shall be responsible or liable for misuse of the information contained herein.

Ordering and shipping details

GTIN	03606480282089
Nbr. of units in pkg.	1
Package weight(Lbs)	2.12 oz (60 g)

Packing Units

Unit Type of Package 1	PCE
Package 1 Height	3.54 in (9 cm)
Package 1 width	0.69 in (1.76 cm)
Package 1 Length	2.56 in (6.5 cm)

Offer Sustainability

California proposition 65	WARNING: This product can expose you to chemicals including: Nickel compounds, which is known to the State of California to cause cancer, and Di-isodecyl phthalate (DIDP), which is known to the State of California to cause birth defects or other reproductive harm. For more information go to www.P65Warnings.ca.gov
REACH Regulation	REACH Declaration
REACH free of SVHC	Yes
EU RoHS Directive	Pro-active compliance (Product out of EU RoHS legal scope) EU RoHS Declaration
Toxic heavy metal free	Yes
Mercury free	Yes
RoHS exemption information	Yes
China RoHS Regulation	China RoHS Declaration
WEEE	The product must be disposed on European Union markets following specific waste collection and never end up in rubbish bins.

Approximate Dimensions

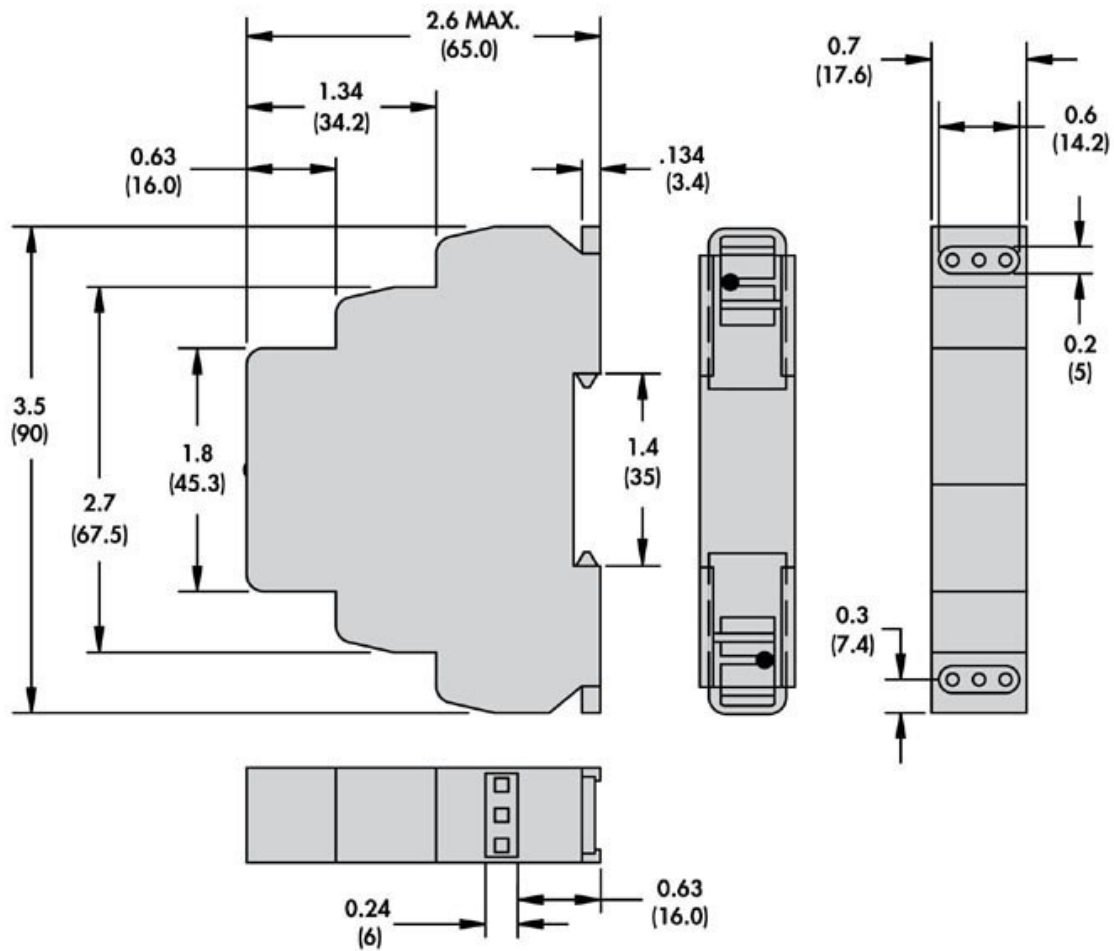

Connections and Wiring Diagrams

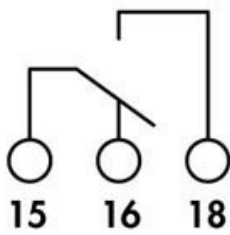
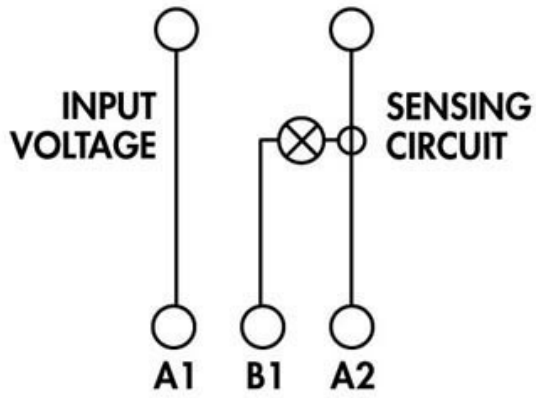

15 - COMMON
16 - NORMALLY CLOSED
18 - NORMALLY OPEN