

Glenair's right angle 801-023 connectors offer military grade performance in a small, lightweight package. These connectors are rated for MIL-STD-810 Method 512 immersion. High temperature thermoplastic housing withstands soldering temperatures. Stainless steel threaded inserts simplify attachment to printed circuit board.

- **Double-Start ACME Thread**
- **Right Angle Contacts**
- **High Temperature Housing**
- **Threaded Inserts**
- **Environmentally Sealed**

Series 801 Right Angle PCB Receptacle

HOW TO ORDER

Sample Part Number

801-023	-07	M	7-10	P	A
Series	Shell Style	Shell Material / Finish	Shell Size- Insert Arrangement	Contact Type	Shell Key Position
801-023 PCB Receptacle for Right Angle PC Board	-07 Jam Nut	C Aluminum / Black Anodize (Non-Conductive) RoHS Compliant	No. of Arrangement Contacts <hr/> 5-3 3 <hr/> 6-4 4 <hr/> 6-7 7 <hr/> 7-10 10 <hr/> 8-13 13 <hr/> 9-19 19	P Pin S Socket	A Normal B Pos. B C Pos. C D Pos. D E Pos. E F Pos. F
		M Aluminum / Electroless Nickel RoHS Compliant			
		NF Aluminum / Cadmium with Olive Drab Chromate			
		ZN Aluminum / Zinc-Nickel with Olive Drab Chromate			
		ZNU Aluminum / Zinc-Nickel with Black Chromate			
		MT Aluminum / Nickel-PTFE RoHS Compliant			
		Z1 Stainless Steel / Passivated			

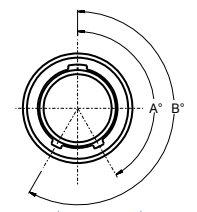

	A°	B°
A	150°	210°
B	75°	210°
C	95°	230°
D	140°	275°
E	75°	275°
F	95°	210°

Dimensions in inches (millimeters) and are subject to change without notice.

Series 801 Mighty Mouse Double-Start ACME Threads Jam Nut Connector Dimensions

801-023-07



Series 801

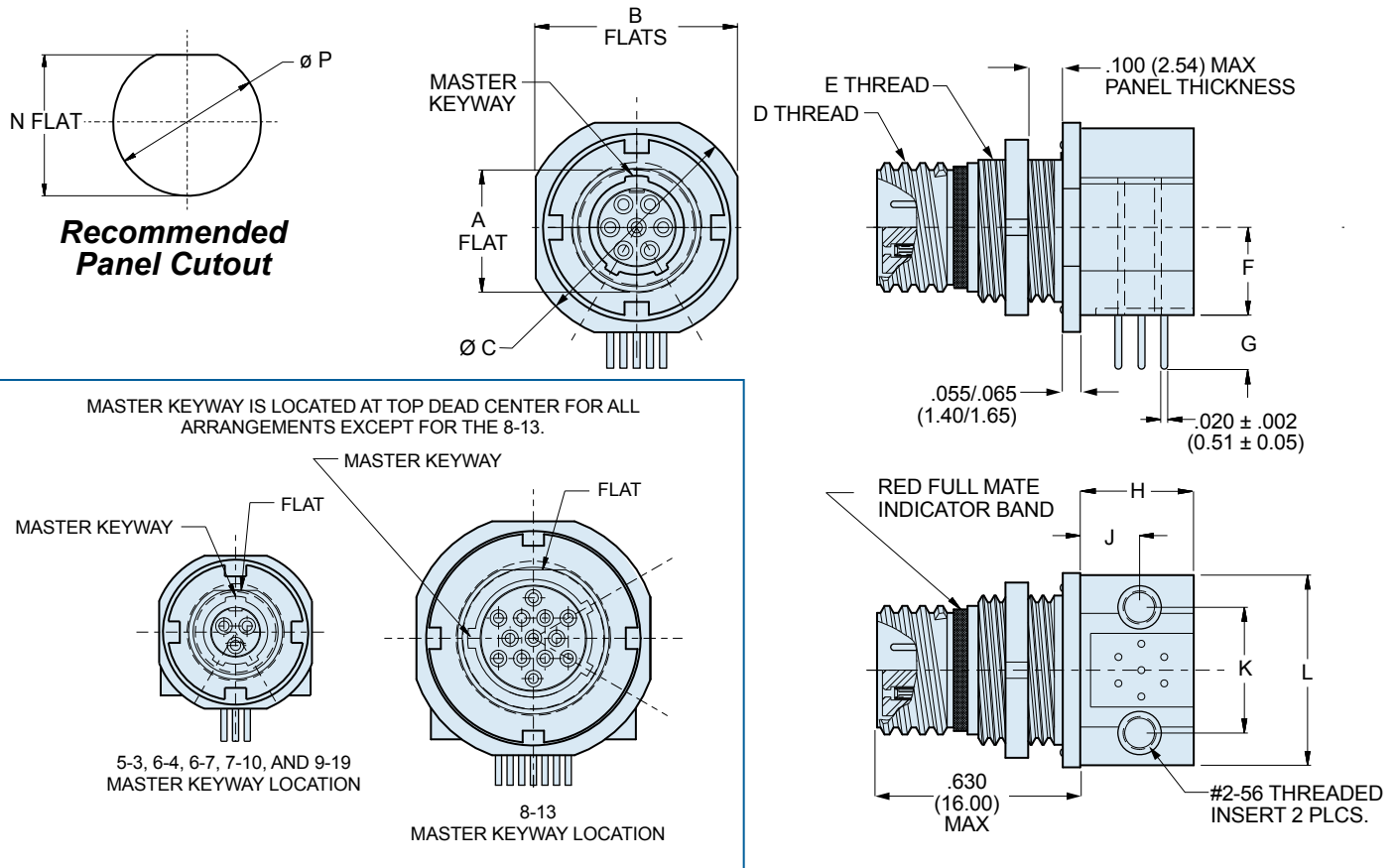

DIMENSIONS

Shell Size/ Contact Arr.	A		B		Ø C		D Thread	E Thread	F		G	
	In.	mm.	In.	mm.	In.	mm.			In.	mm.	In.	mm.
	±.005	±0.13							±.035	±0.89		
5-3	.350	8.89	.545	13.84	.580	14.73	.3125-.05P-.1L-2A	.375-28 UN-2A	.225	5.72	.275	6.99
6-4	.410	10.41	.602	15.29	.635	16.13	.3750-.05P-.1L-DS-2A	.4375-28 UNEF-2A	.225	5.72	.292	7.42
6-7	.410	10.41	.602	15.29	.635	16.13	.3750-.05P-.1L-DS-2A	.4375-28 UNEF-2A	.225	5.72	.265	6.73
7-10	.536	13.61	.723	18.36	.755	19.18	.4375-.05P-.1L-DS-2A	.5625-32 UN-2A	.296	7.52	.273	6.93
8-13	.536	13.61	.723	18.36	.755	19.18	.5000-.05P-.1L-DS-2A	.5625-32 UN-2A	.319	8.10	.316	8.03
9-19	.595	15.11	.790	20.01	.830	21.08	.5625-.05P-.1L-DS-2A	.6250-28 UN-2A	.360	9.14	.275	6.99
Shell Size/ Contact Arr.	H		J		K		L		N		P	
	In.	mm.	In.	mm.	In.	mm.	In.	mm.	In.	mm.	In.	mm.
									±.002	±0.05	±.005	±0.13
5-3	.260	6.60	.165	4.19	.310	7.87	.490	14.45	.357	9.07	.385	9.78
6-4	.345	8.76	.224	5.69	.385	9.78	.589	15.19	.418	10.62	.448	11.37
6-7	.345	8.76	.187	4.75	.408	10.36	.589	15.19	.418	10.62	.448	11.37
7-10	.345	8.76	.170	4.32	.452	11.48	.710	18.03	.544	13.82	.573	14.55
8-13	.490	12.45	.230	5.84	.490	12.45	.710	18.03	.544	13.82	.573	14.55
9-19	.490	12.45	.342	8.69	.600	15.24	.800	20.32	.603	15.32	.635	16.13

Dimensions in inches (millimeters) and are subject to change without notice.

© 2010 Glenair, Inc.

CAGE Code 06324

Printed in U.S.A.

GLENAIR, INC. • 1211 AIR WAY • GLENDALE, CA 91201-2497 • 818-247-6000 • FAX 818-500-9912

www.glenair.com

D-15

E-Mail: sales@glenair.com

01-JANUARY-2010



Series 801 Mighty Mouse Double-Start ACME Threads Right Angle PCB Receptacles 801-023 PCB Footprints

RIGHT ANGLE PCB FOOTPRINTS: PIN CONNECTORS

Patterns shown are for component mounting side of PCB.
Contacts are .022 (0.56) max. diameter, mounting holes are .093 (2.36) diameter

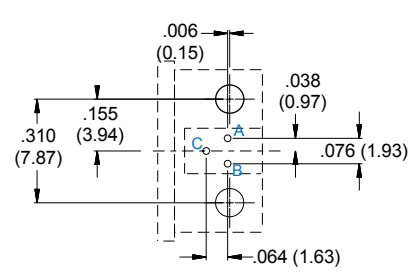

5-3P

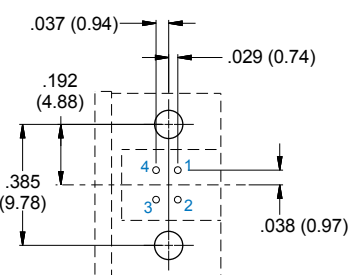

6-4P

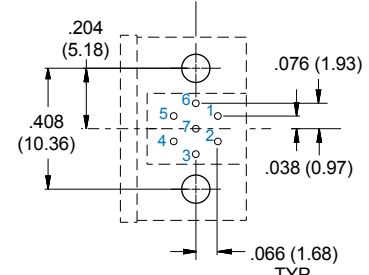

6-7P

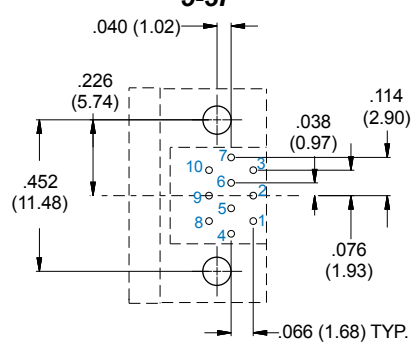

7-10P

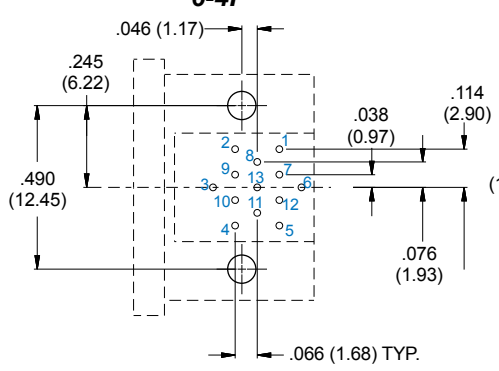

8-13P

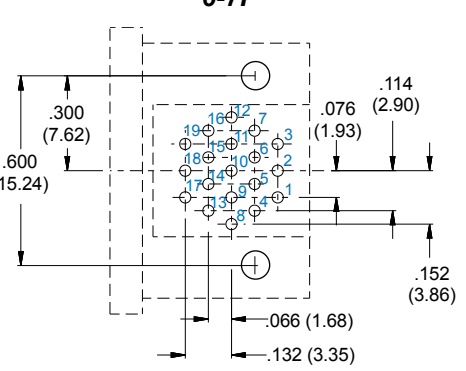

9-19P

RIGHT ANGLE PCB FOOTPRINTS: SOCKET CONNECTORS

Patterns shown are for component mounting side of PCB.

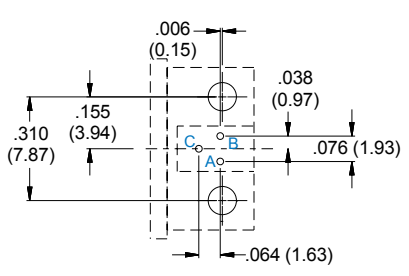

5-3S

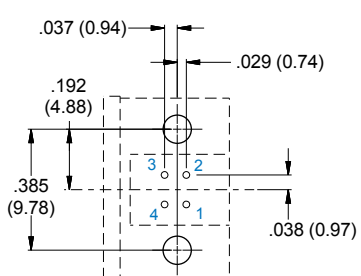

6-4S

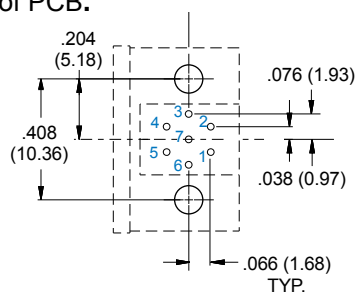

6-7S

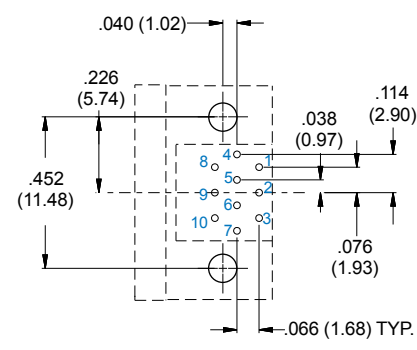

7-10S

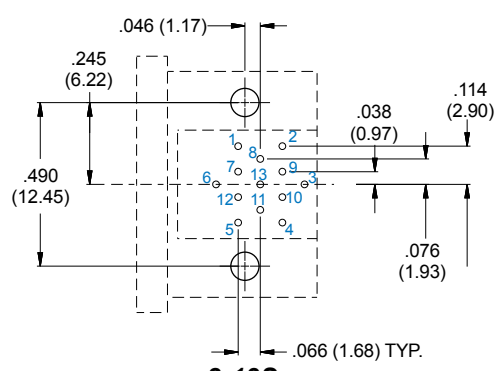

8-13S

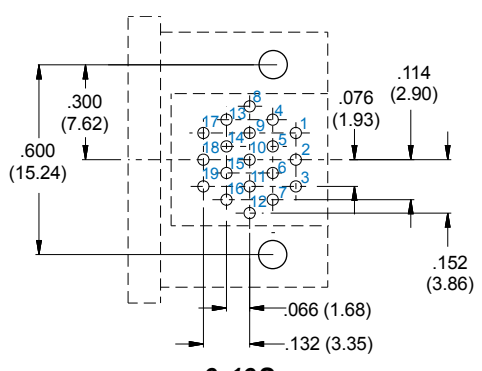

9-19S

Dimensions in inches (millimeters) and are subject to change without notice.