

Description

Magnecraft™ General Purpose Relays

782 Power Series

SPDT 20 A; DPDT 15 A



UL listed when used with proper Magnecraft™ sockets



782 Clear Cover



782 Full-Feature Cover

Description

The 782 Plug-in Power relays offer clear or full-feature covers with multiple mounting options and accessories.

Feature	Benefit
20 A / 15 A max. switching current	Ideal for automation control panels
Clear or full-feature cover options	Full-feature covers include LED indicator & locking test button
Socket mount option	Simplifies installation & maintenance while also allowing the use of protection modules, hold-down clips & other accessories
Gold-flashed contacts	Reduces contact oxidation & increases shelf life
Mechanical flag indicator	Standard feature displays relay status during testing or operation

Contact Rating	Contact Configuration	Nominal Voltage	Coil Resistance (Ω)	Feature	Standard Part Number: Clear Cover	Standard Part Number: Full-Feature
15 A	DPDT	24 Vac 50/60 Hz	180	-	782XBXC-24D	782XBM4L-24A
				LED	782XBXCL-24A	-
		120 Vac 50/60 Hz	4430	-	782XBXC-120A	782XBM4L-120A
				PC Terminals	782XBXCT-120A	-
		220/240 Vac 50/60 Hz	15720	-	782XBXC-24A	782XBM4L-240A
		12 Vdc	160	-	782XBXC-12D	782XBM4L-12D
				PC Terminals	782XBXCT-12D	-
		24 Vdc	650	-	-	782XBM4L-24D
				PC Terminals	782XBXCT-24D	-
		110/125 Vdc	11000	-	782XBXC-110D	782XBM4L-110D
				LED	782XBXCL-110D	-
		20 A	SPDT	24 Vac 50/60 Hz	180	-
120 Vac 50/60 Hz	4430			-	-	782XAXM4L-120A
220/240 Vac 50/60 Hz	15720			-	782XAXC-240A	782XAXM4L-240A
12 Vdc	160			-	-	782XAXM4L-12D
24 Vdc	650			-	-	782XAXM4L-24D
110/125 Vdc	11000			-	782XAXC-110D	782XAXM4L-110D
-	-			-	-	-

Part Number Explanation

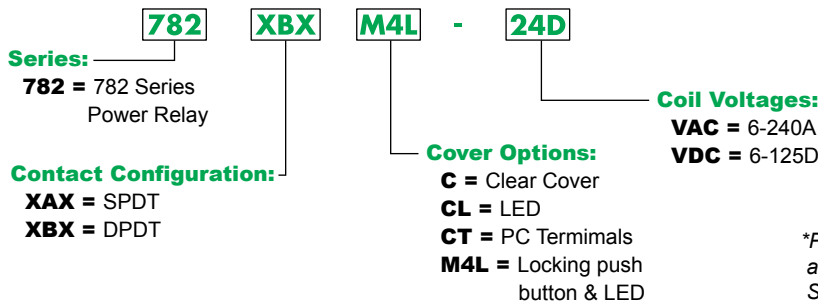

*Please note that LED-only versions are also available. Please contact Customer Service for more information (847-441-2540).

Specifications (UL 508)

Part Number	782XAX	782XBXC / CL / M4L	782XBXCT
Contact Characteristics			
Terminal Style	Blade	Blade	PC Terminals
Contact Configuration	SPDT	DPDT	
Maximum Current	20 A	15 A	
Contact Materials	Silver Alloy	Silver Alloy	
Maximum Switching Voltage	300 V	300 V	
Rated Switching Current at Voltage	Resistive: 20 A at 120 Vac 50/60 Hz; 20 A at 277 Vac 50/60 Hz; 20 A at 28 Vdc Motor: 1 hp at 250 Vac 50/60 Hz; 1/2 hp at 120 Vac 50/60 Hz Pilot Duty: B300	Resistive: 10 A at 277 Vac 50/60 Hz (CSA); 12 A at 277 Vac 50/60 Hz; 15 A at 120 Vac 50/60 Hz; 12 A at 28 Vdc Motor: 1 hp at 250 Vac 50/60 Hz; 1/2 hp at 120 Vac 50/60 Hz Pilot Duty: B300	
Minimum Switching Requirement	100 mA at 5 Vdc (0.5 W)	100 mA at 5 Vdc (0.5 W)	
Coil Characteristics			
Maximum Operating Voltage	110% (AC / DC)	110% (AC / DC)	
Maximum Pickup Voltage	85% (AC); 80% (DC)	85% (AC); 80% (DC)	
Drop-out Voltage Threshold	15% (AC); 10% (DC)	15% (AC); 10% (DC)	
Average Consumption	1.2 VA (AC); 0.9 W (DC)	1.2 VA (AC); 0.9 W (DC)	
General Characteristics			
Electrical Life at Rated Load	100,000 operations	100,000 operations	
Mechanical Life (Unpowered)	10,000,000 operations	10,000,000 operations	
Operating Time (Response Time)	20 ms	20 ms	
Dielectric Strength - Between Coil and Contact (AC)	1600 V(rms)	1600 V(rms)	
Dielectric Strength - Between Poles (AC)	1600 V(rms)	1600 V(rms)	
Ambient Air Temperature around the Device - Storage	-40 – +85 °C (-40 – +185 °F)	-40 – +85 °C (-40 – +185 °F)	
Ambient Air Temperature around the Device - Operation	-40 – +55 °C (-40 – +131 °F)	-40 – +55 °C (-40 – +131 °F)	
Vibration Resistance - Operational	3 g-n at 10-55 Hz	3 g-n at 10-55 Hz	
Shock Resistance	10 g-n	10 g-n	
Degree of Protection	IP 40	IP 40	
Weight	36 g (1.27 oz)	36 g (1.27 oz)	
Agency Approvals	UL with socket, UR (E43641), CE, CSA (LR40787), RoHS	UL with socket, UR (E43641), CE, CSA (LR40787), RoHS	

Note: Actual product performance may vary depending on application and environmental conditions.

Dimensions — inches (millimeters)

Clear Cover Dimensions

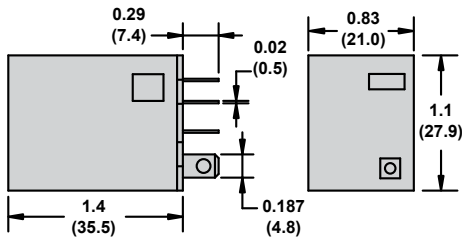

Printed Circuit Terminals

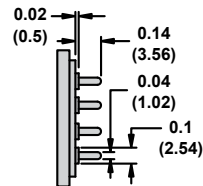

Full-Feature Cover Dimensions

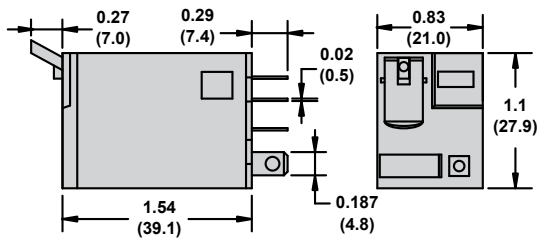

Terminal Layout

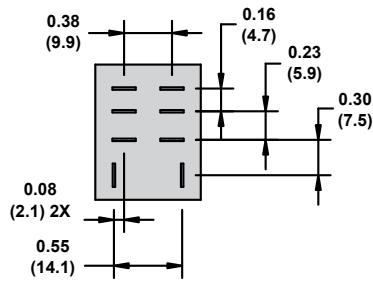

Wiring Diagrams

SPDT

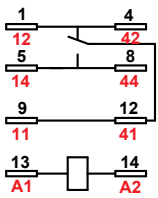

NEMA
IEC

DPDT

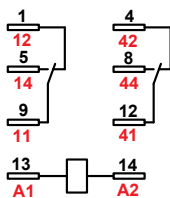

NEMA
IEC

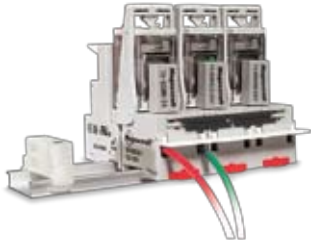

Description

Optional sockets offer customizable, finger-safe™ solutions including protection modules, hold-down clips, and ID tags. Sockets are DIN rail and panel mount compatible.

Relay Accessories

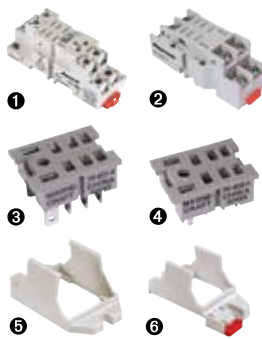

Description	Function	For Use With Relays	Pkg. Min.	Standard Part Number
Socket 1	DIN/Panel mount with screw terminals & clamping plates	782XAX / 782XBX	10	70-782D8-1A
Socket 2	DIN/Panel mount with screw terminals & clamping plates		10	70-459-1
Socket 3	Quick Connect terminals for chassis mount		10	70-401-1
Socket 4	Printed circuit terminals for PCB mount		10	70-402-1
Adapter 5	Mount directly to panel		10	16-782C1
Adapter 6	Mount directly to DIN rail		10	16-782C

Socket Accessories

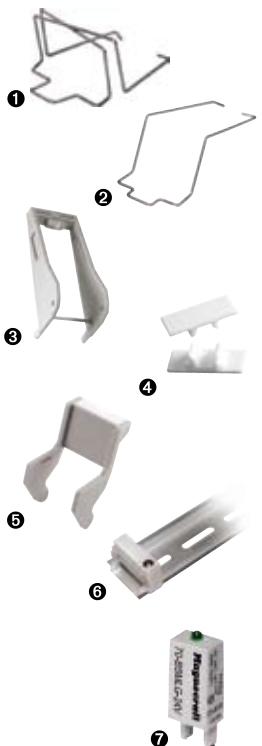

Description	Function	For Use With Sockets	Coil Voltage	Pkg. Min.	Standard Part Number
Metal Spring Clip 1 2	Secures relay in socket	70-782D8-1A, 70-459-1, 70-401-1, 70-402-1	–	10	16-1342
Plastic Hold-Down Clip 3	Secures relay in socket or ejects relay off socket	70-782D8-1A	–	10	16-782PC-1
Write-on tag 4	Write-on tag for 16-782PC-1 hold-down Clip	–	–	10	16-700ST-1
Plastic ID Hold-Down Clip 5	Secures relay in socket and provides labeling	70-782D8-1A, 70-459-1, 70-401-1, 70-402-1	–	10	16-782IDC
Extruded Aluminum DIN Rail, 39.37" (1000 mm) 6	Quick installation and removal of sockets	70-782D8-1A, 70-459-1	–	10	16-700DIN
DIN Rail End Clip 6	Holds sockets firmly in place on DIN rail	70-782D8-1A, 70-459-1	–	10	16-DCLIP-1
Small Socket Module	Protection Diode (Protects external drive circuitry from inductive voltages)	70-782D8-1A	6 to 250 Vdc	10	70-BSMD-250
Small Socket Module 7	LED Indicator (Provides coil status at a glance)		24 Vac/Vdc	10	70-BSMLG-24
Small Socket Module	MOV Suppressor (Protects from damaging electrical spikes)		120 Vac/Vdc	10	70-BSMM-120
			24 Vac/Vdc	10	70-BSMM-24
Small Socket Module			240 Vac/Vdc	10	70-BSMM-240

Note: Use of LED socket module may increase coil power draw by up to 10%.

Description

Magnecraft™ General Purpose Relays

782 Control Series

DPDT 3 A and 10 A; 4PDT 3 A and 10 A



UL listed when used with proper Magnecraft™ sockets



782 Clear Cover



782 Full-Feature Cover

Description

The 782 Plug-in Control relays offer clear or full-feature covers with multiple mounting options and accessories; 4PDT models save valuable space while adding increased functionality.

Feature	Benefit
10 A / 3 A max. switching current	Ideal for automation panels & controls
Clear or full-feature cover options	Full-feature covers include LED indicator & locking test button
DPDT & 4PDT contact	Simultaneously control separate circuit configurations
Socket mount option	Simplifies installation and maintenance while also allowing the use of protection modules, hold-down clips & other accessories
Gold-flashed contacts	Reduces contact oxidation & increases shelf life
Mechanical flag indicator	Standard feature displays relay status during testing or operation

Contact Rating	Contact Configuration	Nominal Voltage	Coil Resistance (Ω)	Feature	Standard Part Number: Clear Cover	Standard Part Number: Full-Feature
3 A	4PDT	12 Vac 50/60 Hz	46	Bifurcated Contacts	782XDX3C-12A	–
		24 Vac 50/60 Hz	180	Bifurcated Contacts	782XDX3C-24A	782XDX3M4L-24A
				Gold Diffused Contacts	782XDX1C-24A	–
		120 Vac 50/60 Hz	4430	Bifurcated Contacts	782XDX3C-120A	782XDX3M4L-120A
				Gold Diffused Contacts	782XDX1C-120A	782XDX1M4L-120A
		12 Vdc	160	Bifurcated Contacts	782XDX3C-12D	782XDX3M4L-12D
				Gold Diffused Contacts	782XDX1C-12D	782XDX1M4L-12D
		24 Vdc	650	Bifurcated Contacts	782XDX3C-24D	782XDX3M4L-24D
				Gold Diffused Contacts	782XDX1C-24D	782XDX1M4L-24D
		110/125 Vdc	11000	Bifurcated Contacts	782XDX3C-110D	–
10 A	DPDT	24 Vac 50/60 Hz	180	–	–	782XBX2M4L-24A
		120 Vac 50/60 Hz	4430	–	–	782XBX2M4L-120A
		12 Vdc	160	–	–	782XBX2M4L-12D
		24 Vdc	650	–	–	782XBX2M4L-24D
		110/125 Vdc	11000	–	–	782XBX2M4L-110D
	4PDT	24 Vac 50/60 Hz	180	–	–	782XDX2M4L-24A
		120 Vac 50/60 Hz	4430	–	782XDX2C-120A	782XDX2M4L-120A
		12 Vdc	160	–	–	782XDX2M4L-12D
		24 Vdc	650	–	782XDX2C-24D	782XDX2M4L-24D
		110/125 Vdc	11000	–	–	782XDX2M4L-110D

Part Number Explanation

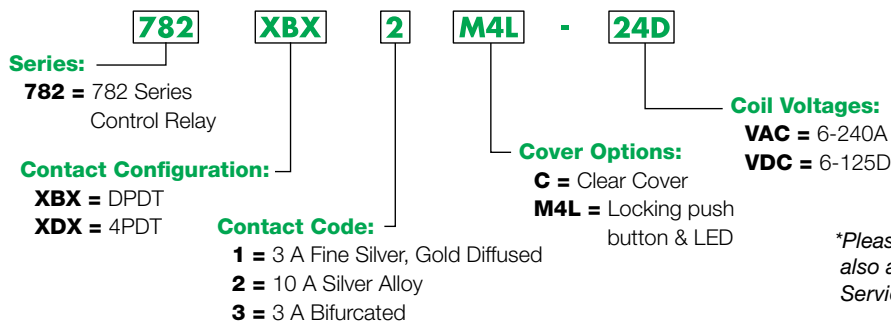

Specifications (UL 508)

Part Number	782XBX1	782XBX2	782XBX3
Contact Characteristics			
Terminal Style	Blade	Blade	Blade
Contact Configuration	DPDT	DPDT	DPDT
Maximum Current	3 A	10 A	3 A
Load Type	Low Level	Standard	Low Level
Contact Materials	Fine Silver	Silver Alloy	Bifurcated
Maximum Switching Voltage	300 V	300 V	300 V
Rated Switching Current at Voltage	Resistive: 3 A at 120 Vac 50/60 Hz; 3 A at 277 Vac 50/60 Hz; 3 A at 30 Vdc Motor: 1/16 hp at 120 Vac 50/60 Hz Pilot Duty: B300	Resistive: 10 A at 120 Vac 50/60 Hz; 8 A at 277 Vac 50/60 Hz; 8 A at 28 Vdc Motor: 1 hp at 277 Vac 50/60 Hz; 1/3 hp at 120 Vac 50/60 Hz Pilot Duty: B300	Resistive: 3 A at 120 Vac 50/60 Hz; 3 A at 277 Vac 50/60 Hz; 3 A at 30 Vdc Motor: 1/16 hp at 120 Vac 50/60 Hz Pilot Duty: B300
Minimum Switching Requirement	10 mA at 5 Vdc (0.5 W)	100 mA at 5 Vdc (0.5 W)	10 mA at 5 Vdc (0.5 W)
Coil Characteristics			
Maximum Operating Voltage	110% (AC / DC)	110% (AC / DC)	110% (AC / DC)
Maximum Pickup Voltage	85% (AC); 80% (DC)	85% (AC); 80% (DC)	85% (AC); 80% (DC)
Drop-out Voltage Threshold	15% (AC); 10% (DC)	15% (AC); 10% (DC)	15% (AC); 10% (DC)
Average Consumption	1.2 VA (AC); 0.9 W (DC)	1.2 VA (AC); 0.9 W (DC)	1.2 VA (AC); 0.9 W (DC)
General Characteristics			
Electrical Life at Rated Load	100,000 operations	200,000 operations	100,000 operations
Mechanical Life (Unpowered)	10,000,000 operations	10,000,000 operations	10,000,000 operations
Operating Time (Response Time)	20 ms	20 ms	20 ms
Dielectric Strength - Between Coil and Contact (AC)	1600 V(rms)	1600 V(rms)	1600 V(rms)
Dielectric Strength - Between Poles (AC)	1600 V(rms)	1600 V(rms)	1600 V(rms)
Ambient Air Temperature around the Device - Storage	-40 – +85 °C (-40 – +185 °F)	-40 – +85 °C (-40 – +185 °F)	-40 – +85 °C (-40 – +185 °F)
Ambient Air Temperature around the Device - Operation	-40 – +55 °C (-40 – +131 °F)	-40 – +55 °C (-40 – +131 °F)	-40 – +55 °C (-40 – +131 °F)
Vibration Resistance - Operational	3 g-n at 10-55 Hz	3 g-n at 10-55 Hz	3 g-n at 10-55 Hz
Shock Resistance	10 g-n	10 g-n	10 g-n
Degree of Protection	IP 40	IP 40	IP 40
Weight	36 g (1.27 oz)	36 g (1.27 oz)	36 g (1.27 oz)
Agency Approvals	UL with socket, UR (E43641), CE, CSA (LR40787), RoHS	UL with socket, UR (E43641), CE, CSA (LR40787), RoHS	UL with socket, UR (E43641), CE, CSA (LR40787), RoHS

Note: Actual product performance may vary depending on application and environmental conditions.

Specifications (UL 508) (continued)

Part Number	782XDX1	782XDX2	782XDX3
Contact Characteristics			
Terminal Style	Blade	Blade	Blade
Contact Configuration	4PDT	4PDT	4PDT
Maximum Current	3 A	10 A	3 A
Load Type	Standard	Standard	Low Level
Contact Materials	Fine Silver	Silver Alloy	Bifurcated
Maximum Switching Voltage	300 V	300 V	300 V
Rated Switching Current at Voltage	Resistive: 10 A at 120 Vac 50/60 Hz; 8 A at 277 Vac 50/60 Hz; 8 A at 28 Vdc Motor: 1 hp at 277 Vac 50/60 Hz; 1/3 hp at 120 Vac 50/60 Hz Pilot Duty: B300	Resistive: 10 A at 120 Vac 50/60 Hz; 8 A at 277 Vac 50/60 Hz; 8 A at 28 Vdc Motor: 1 hp at 277 Vac 50/60 Hz; 1/3 hp at 120 Vac 50/60 Hz Pilot Duty: B300	Resistive: 3 A at 120 Vac 50/60 Hz; 3 A at 277 Vac 50/60 Hz; 3 A at 30 Vdc Motor: 1/16 hp at 120 Vac 50/60 Hz Pilot Duty: B300
Minimum Switching Requirement	100 mA at 5 Vdc (0.5 W)	100 mA at 5 Vdc (0.5 W)	10 mA at 5 Vdc (0.5 W)
Coil Characteristics			
Maximum Operating Voltage	110% (AC / DC)	110% (AC / DC)	110% (AC / DC)
Maximum Pickup Voltage	85% (AC); 80% (DC)	85% (AC); 80% (DC)	85% (AC); 80% (DC)
Drop-out Voltage Threshold	15% (AC); 10% (DC)	15% (AC); 10% (DC)	15% (AC); 10% (DC)
Average Consumption	1.2 VA (AC); 0.9 W (DC)	1.2 VA (AC); 0.9 W (DC)	1.2 VA (AC); 0.9 W (DC)
General Characteristics			
Electrical Life at Rated Load	200,000 operations	200,000 operations	200,000 operations
Mechanical Life (Unpowered)	10,000,000 operations	10,000,000 operations	10,000,000 operations
Operating Time (Response Time)	20 ms	20 ms	20 ms
Dielectric Strength - Between Coil and Contact (AC)	1600 V(rms)	1600 V(rms)	1600 V(rms)
Dielectric Strength - Between Poles (AC)	1600 V(rms)	1600 V(rms)	1600 V(rms)
Ambient Air Temperature around the Device - Storage	-40 – +85 °C (-40 – +185 °F)	-40 – +85 °C (-40 – +185 °F)	-40 – +85 °C (-40 – +185 °F)
Ambient Air Temperature around the Device - Operation	-40 – +55 °C (-40 – +131 °F)	-40 – +55 °C (-40 – +131 °F)	-40 – +55 °C (-40 – +131 °F)
Vibration Resistance - Operational	3 g-n at 10-55 Hz	3 g-n at 10-55 Hz	3 g-n at 10-55 Hz
Shock Resistance	10 g-n	10 g-n	10 g-n
Degree of Protection	IP 40	IP 40	IP 40
Weight	36 g (1.27 oz)	36 g (1.27 oz)	36 g (1.27 oz)
Agency Approvals	UL with socket, UR (E43641), CE, CSA (LR40787), RoHS	UL with socket, UR (E43641), CE, CSA (LR40787), RoHS	UL with socket, UR (E43641), CE, CSA (LR40787), RoHS

Note: Actual product performance may vary depending on application and environmental conditions.

Dimensions — inches (millimeters)

Clear Cover Dimension

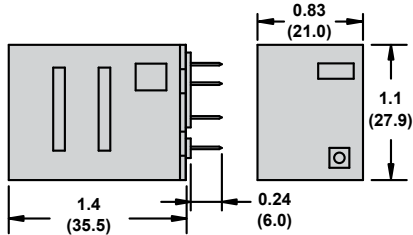

Full-Feature Cover Dimension

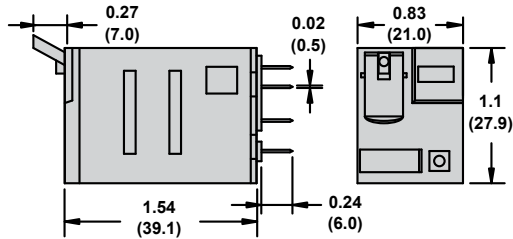

Wiring Diagrams

DPDT

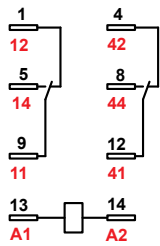

NEMA
IEC

4PDT

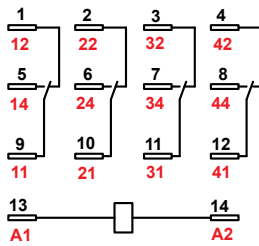

NEMA
IEC

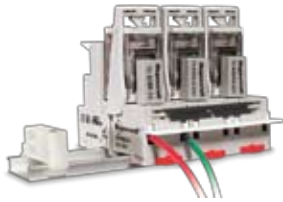

Description

Optional sockets offer customizable, finger-safe™ solutions including protection modules, hold-down clips, and ID tags. Sockets are DIN rail and panel mount compatible.

Relay Accessories

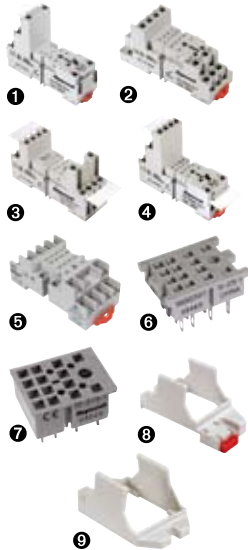

Description	Function	For Use With Relays	Pkg. Min.	Standard Part Number
Socket 1	DIN/Panel mount with elevator terminals	782XBX1,2,3	10	70-782EL8-1
Socket 2	DIN/Panel mount with screw terminals & clamping plates	782XBX1,2,3 / 782XDX1,2,3	10	70-782D14-1
Socket 3	DIN/Panel mount with rising elevator box terminals	782XBX1,2,3 / 782XDX1,2,3	10	70-782E14-1
Socket 4	DIN/Panel mount with elevator terminals	782XBX1,2,3 / 782XDX1,2,3	10	70-782EL14-1
Socket 5	DIN/Panel mount with screw terminals & clamping plates	782XDX1,2,3	10	70-461-1
Socket 6	Solder terminals for chassis mount	782XDX1,2,3	10	70-378-1
Socket 7	Printed circuit terminals for PCB mount	782XDX1,2,3	10	70-379-1
Adapter 8	Mount directly to DIN rail	782XBX1,2,3 / 782XDX1,2,3	10	16-782C
Adapter 9	Mount directly to panel	782XBX1,2,3 / 782XDX1,2,3	10	16-782C1

Socket Accessories



Description	Function	For Use With Sockets	Coil Voltage	Pkg. Min.	Standard Part Number
Metal Spring Clip 1	Secures relay in socket	70-782D14-1, 70-782E14-1, 70-782EL14-1, 70-782EL8-1	–	10	16-782SC
Plastic Hold-Down Clip 2	Secures relay in socket or ejects relay off socket		–	10	16-782PC-1
Write-on tag 3	Small Write-on tag	–	–	10	16-782FT-1
Write-on tag 4	Write-on tag for 16-782PC-1 Hold-down Clip	–	–	10	16-700ST-1
Extruded Aluminum DIN Rail, 39.37" (1000 mm) 5	Quick installation and removal of sockets	70-782D14-1, 70-782E14-1, 70-782EL8-1, 70-782EL14-1	–	10	16-700DIN
DIN Rail End Clip 6	Holds sockets firmly in place on DIN rail	–	–	10	16-DCLIP-1
Insulated Coil Bus Jumper System 7	Wireless socket connection	70-782EL8-1, 70-782EL14-1	–	10	16-782CBJ-1
Small Socket Module	Protection Diode (Protects external drive circuitry from inductive voltages)	70-782D14-1, 70-782E14-1, 70-782EL14-1, 70-782EL8-1	6 to 250 Vdc	10	70-BSMD-250
Small Socket Module 7	LED Indicator (Provides coil status at a glance)		24 Vac/Vdc	10	70-BSMLG-24
Small Socket Module	MOV Suppressor (Protects from damaging electrical spikes)		120 Vac/Vdc	10	70-BSMM-120
			24 Vac/Vdc	10	70-BSMM-24
			240 Vac/Vdc	10	70-BSMM-240

Note: Use of LED socket module may increase coil power draw by up to 10%.