

**Model 72967
SMA JACK (F) / JACK (F), REVERSE POLARITY**



Model 72967 SMA JACK (F) / JACK (F), REVERSE POLARITY

High bandwidth, small size, and durability for confident connections

Features

- DC - 6 GHz
- Meets MIL-C-39012, IEC 169-15, CECC 22110.
- Small size and durability for mobile communications.
- Precision machined and gold-plated for low loss.

Materials

- Body is machined brass with gold plating.
- Center Contacts - Plug is gold plated brass and Jack is gold plated Beryllium copper.
- Insulators are high quality PTFE.
- Crimp Ferrules are copper with gold or nickel plating.
- Gaskets are silicone rubber.

Ordering Information

Model: 72967
Description: SMA JACK (F) / JACK (F), REVERSE POLARITY

USA: Sales: 800-490-2361
Technical Support: technicalsupport@pomonatest.com
Fax: 425-446-5844
Europe: 31-(0) 40 2675 150 **International:** 425-446-5500
Where to Buy: www.pomonaelectronics.com

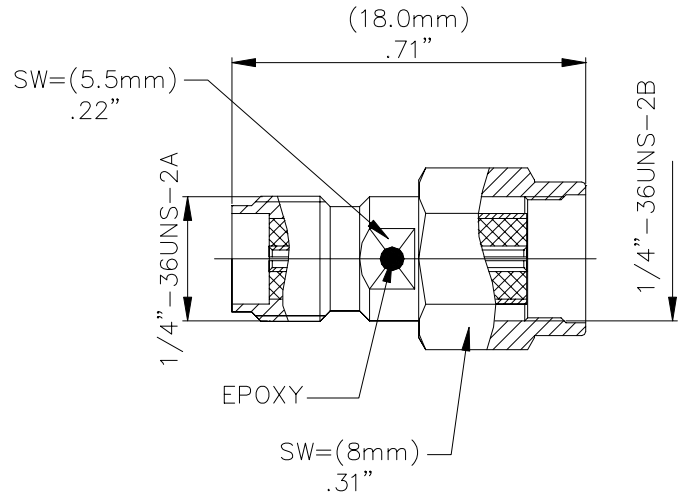

Specifications

Impedance	50 Ω
Frequency Range	DC – 6 GHz
Working Voltage	< 500 V _{peak}
Dielectric Withstanding Voltage	1,000 V _{rms}
VSWR	1.35 max.
Center/Outer Contact Resistance	0.003/0.002 Ω max
Insulation resistance	> 5000 MΩ
Number of Insertions	500 cycles minimum
Temperature Range	-65° C to 165° C, -85° F to 329° F

All dimensions are in inches. Tolerances (except noted): .xx = ±.02" (.51 mm), .xxx = ±.005" (.127 mm). All specifications are to the latest revisions. Specifications are subject to change without notice. Registered trademarks are the property of their respective companies.
D2003384 REV 001