

The Working Environment

The broad range of backshell types available today makes it critical for interconnect engineers, and others tasked with the responsibility of specifying connector accessories to become adept at building backshell part numbers. For the most part, the process entails selecting options from the part number development trees found on each catalog page.

But experience shows it is equally important to consider the working environment of the target application before completing the backshell selection process. There are many electrical, mechanical and environmental considerations which, when properly addressed, will ensure a long functional life for the interconnect system. So before you start building part numbers, please consider the following:

(1) What are the material/finish specifications of the mating connector?

(2) What level of environmental protection is required in the system—from full water immersion, to splash proof and/or moisture resistance?

(3) What level of EMI shielding is required, and is any particular style or type of shield termination generally specified in the target assembly?

(4) What level or amount of strain-relief, from light duty to gorilla proof, is required to protect shield and conductor terminations from damage?

(5) What is the temperature range of the application environment? Is it so hot that stainless steel is called for, or so cold that an elastomeric seal might potentially fail?

(6) Is repairability a design requirement? Some split shell designs make field repair a snap, while solid shell models make accessing contact terminations more difficult.

(7) Are there size or shape constraints which need to be considered? Is working room so important that an extender needs to be designed in? Or is available space so tight that an ultra low profile backshell design is called for? Does cable routing dictate 45°, 90° or straight cable entries?

(8) Is a metal shell required or is saving weight and preventing corrosion with composite thermo-plastic materials an option?

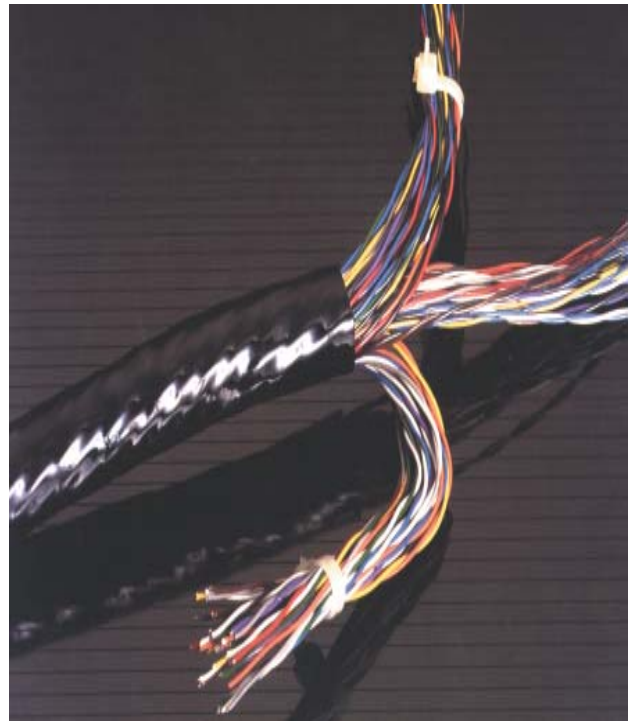

An accurate estimate of the cable diameter is required to select the right backshell cable entry diameter. Complete the cable analysis before selecting the backshell.

(9) Does the application require conformance to AS85049 or another specification?

Cable Make-up

Other questions in backshell selection cannot be answered without an understanding of the overall make-up of the cable and harness. Basic dimensional decisions on cable entry size cannot be specified without accurate descriptions and measurements of the cable or wire bundle. A basic analysis of the cable should include:

- **Wire Numbers and Types:** twisted shielded pairs, coaxial power, signal, fiber optic, etc.
- **Shield Material Gauge, Number and Type:** tin, nickel, silver plated copper wire, and so on.
- **Jacket Material and Thickness.**

The table on the following page will assist you in calculating wire bundle diameter for use in choosing the correct backshell cable entry diameter.



How to Order Circular Connector Backshells

Calculating Wire Bundle Diameter

A backshell's rear cable entry can accommodate only a narrow range of cable diameters. When selecting the backshell cable entry size from the provided tables, it is a good idea to error on the side of too large, as an undersized cable can always be enlarged with tape or a grommet to fit the cable clamp. When calculating wire bundle diameters, note that the gauge # of the wire describes only the diameter of the metal conductor, and not the overall diameter including insulation and/or braids. Refer to the appropriate wire specification for the actual diameter of the wire for use in the following calculations.

Steps	Calculations
(1a) Determine average wire diameter when all wires are the same diameter; or	Given 30 Wires @ .045 DIA Avg. Wire DIA = .045
(1b) Determine average wire diameter when wires are different diameters.	Given 15 Wires @ .045 and 15 Wires @ .135 $15 \times .045 = .68$ $15 \times .135 = 2.03 + \frac{2.71}{30} = 2.71$.090 Avg. Wire DIA
(2) Multiply average wire diameter by factor from Table I below	(1a) $.045 \times 6.7 = .3015$ Core Wire Bundle DIA (1b) $.090 \times 6.7 = .603$ Core Wire Bundle DIA
(3) Add thickness of any shielding or jacketing to core wire bundle diameter (for example, add .025 for braided sleeving)	(1a) $.3015 + .025 = .3265$ Wire Bundle Outside DIA (1b) $.603 + .025 = .628$ Wire Bundle Outside DIA

TABLE I

No. of Wires	1	2	3	4	5	6	7	8	9	10	12	14	16	18	20	24	28	32
Factor	1.0	2.0	2.2	2.4	2.7	2.9	3.0	3.3	3.8	4.0	4.3	4.6	5.0	5.3	5.6	6.0	6.5	6.9
No. of Wires	36	40	45	50	55	60	65	70	75	80	90	100	125	150	175	200	250	300
Factor	7.4	7.7	8.1	8.5	8.9	9.3	9.7	10.1	10.5	10.9	11.6	12.2	13.7	15.0	16.1	17.2	19.3	21.0

Backshell Part Number Development

Glenair follows a standardized format for the development of accessory part numbers, so mastering the process once will enable you to build valid part numbers—from any connector accessory product family—circular, rectangular, composite, fiber optic, and so on. Some differences are of course to be found from one product series to the next because of the range of available options. If in doubt, *QwikCreate, The Glenair Part Number Builder*, is now available on our website and takes all the pain and suffering out of backshell specification. For catalog users, the following steps will serve as general guide to the process.

(1) Select the Product Series: Do you want a dust cap, a banding adapter, an environmental back-

shell or some other type of connector accessory? Use the graphical product selection guide at the beginning of the catalog for help in getting to the right section.

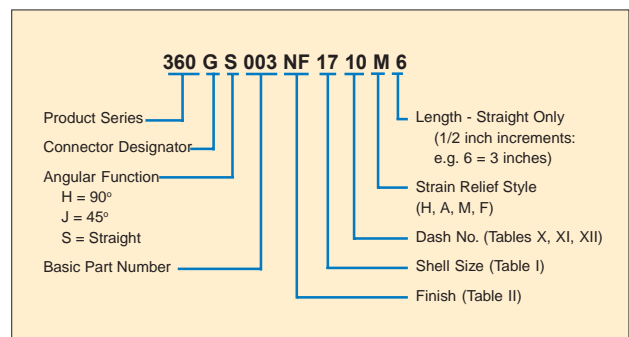

Typical backshell part number development or "How to Order" tree

How to Order Circular Connector Backshells



How
to Order

Angle and Profile

The art of successful backshell selection includes specifying the most appropriate shape and cable entry for each connector accessory.

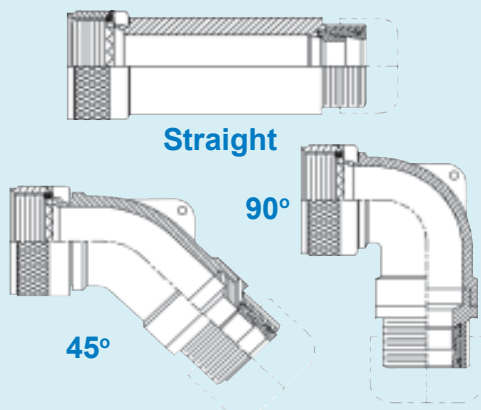

This selection determines working room, repairability, cable routing and the elimination of acute angles. In addition to straight backshells, the range of angles and profiles offered by Glenair include:

- 45° Elbow - Standard Profile
- 45° Elbow - Low Profile
- 45° Elbow - Full Radius Profile
- 45° Elbow - Low Profile Split Shell
- 90° Elbow - Standard Profile
- 90° Elbow - Low Profile
- 90° Elbow - Full Radius Profile
- 90° Elbow - Low Profile Split Shell
- 90° Elbow - Ultra Low Profile Split Shell "Cobra"

(2) Select the Connector Designator: This alphabetic symbol or "designator" is used to match each standardized connector family with the correct backshell thread and interface dimensions. Tables listing all the connector designators used by Glenair can be found beginning on page 15. MIL-DTL-5015 connector users must use an additional manufacturer symbol when ordering backshells. Please see pages 18 and 19 for more information.

(3) Select the Basic Part Number: This number fine-tunes your selection within the product

Strain-Reliefs

Typical Mil-Aero cable assemblies often have over a hundred wires terminated to a single connector. Preventing the wires from pulling on the contacts and damaging the termination is critical, and is usually accomplished with a strain-relief cable clamp that serves to isolate the pulling strain applied to the cable. Strain relief on electrical connectors can be accomplished in other ways, such as with a wire service loop that allows the wire to move between the clamping device and the contact without over-stressing the termination. However the basic method of clamping the wire bundle or cable jacket with saddle bars has historically been the most common method of protecting contact terminations.

- *Straight and Angled Strain Reliefs*

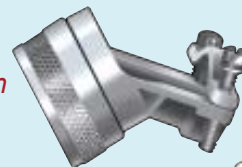

- *Light, Medium and Heavy-Duty Saddle Bars*

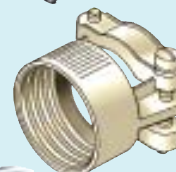

- *Qwik-Ty®*

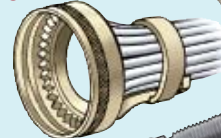

- *QwikClamp®*

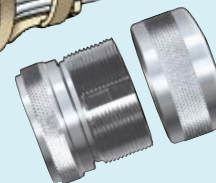

series. For example, for Series 39 EMI/RFI Cable Sealing Backshells, your Basic Part Number selection will tell the factory what style of shield termination technology you prefer and the level of environmental sealing desired. The Basic Part Number also selects for other attributes such as rotatable or direct coupling.

(4) Select the Angle and Profile: Choose 45°, 90° or straight backshells in either standard, low or full radius profiles. Selected parts are also available in Ultra Low Profile Split Shell versions.

How to Order Circular Connector Backshells

(5) Select the Finish Symbol: This symbol, selected from the table on page 14 or from the same table inside the back cover, tells the factory what surface finish or plating should be applied to the product. In almost all cases this selection should match the material finish of your connector.

(6) Select the Connector Shell Size Number: The connector shell size number is taken from Table 1, located on page 13 and repeated again on the inside back cover. The connector shell size number ensures the backshell thread and interface dimensions will fit the chosen size connector. Find the shell size number in the appropriate column according to your connector designator. In certain cases, such as MIL-DTL 38999 Series I and II Connectors (designator F), we have combined both series under a single choice. Simply find your odd connector number or letter in the [brackets] and enter the adjacent number in your part number.

(7) Select the Cable Entry Diameter: This entry specifies the minimum and maximum diameter of cable the backshell accessory can accommodate. Cable entry selection tables are generally found right there on the page. If in doubt, err on the big side, as cables may always be enlarged with tape or a grommet.

(8) Select the Strain Relief Style: Most accessories that are able to accept saddle bar cable clamps offer a range of choices. The selection is usually based on the level or duty of strain-relief that is required, and design drawings of applicable options are featured right there on the catalog page.

(9) Select Unique Options: Other available options, such as drain holes, bands, wire attachment lengths, special material designators, and so on, are tacked on to the end of the part number. In some cases you will be asked to omit the code for a particular option if you do not want it included with the part.

Shield Termination Devices

Selecting the most appropriate shield terminating backshell for a particular application requires a detailed analysis of the cable and the application environment in which the assembly will be used.

EMI/RFI Backshell Designs

Glenair TAG® Ring Backshells



Glenair TAG® Ring Backshells offer a unique and reliable method of terminating individual wire shields.

Raychem Tinel-Lock® Terminators

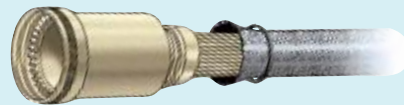

Glenair offers the Raychem Tinel-Lock® termination method. Applied heat causes the alloy ring to contract, clamping the shield to the backshell.

Band-It® Termination System



The unique low profile and smooth inside diameter of the *Band-It*® steel clamping band virtually eliminates EMI leakage paths, providing reliable and repairable shield terminations.

Crimp Ring Termination System

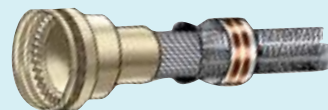

Crimp ring terminations provide an efficient approach to terminating overall cable and harness screens. Individually sized bands are required for each adapter and shield combination.

Conical Ring Style Backshells



Glenair EMI/RFI conical ring backshells provide reliable individual and overall shield termination by securing the shield under pressure between a conically shaped backshell and ground ring.

Cable Sealing Backshell Designs *Submersible Backshells*

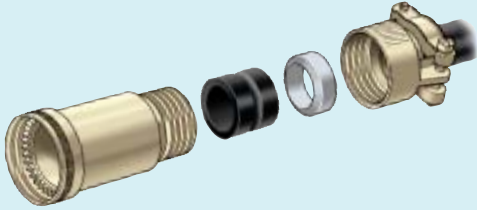

This Cable Sealing Backshell offers immersion protection to 6 ft. when used with impervious jacketed cables. A resilient grommet which fits into a counterbore in the backshell compresses and seals against the cable jacket when the threaded strain relief is tightened. This backshell is described as "submersible" throughout this catalog.

Water-Tight Backshells

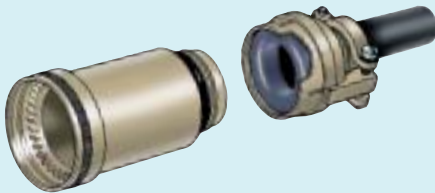

This Cable Sealing Backshell provides a resilient grommet as an integral part of the cable strain relief; it is described as "water-tight" throughout this catalog and prevents water incursion up to 3 ft.

Splash-Proof Backshells

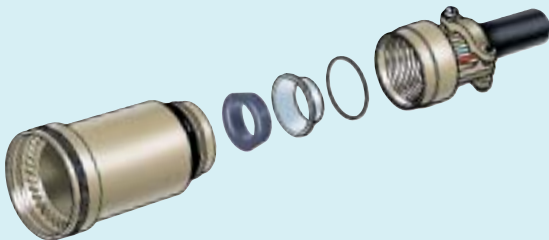

For applications requiring only moisture resistance and sealing against dust, Glenair offers these Environmental Resisting Backshells. An effective sealing barrier is created by a resilient grommet at the backshell cable entry. This backshell design is described as "splash-proof" in this catalog

There is no single shield termination technology or methodology that will meet every customer requirement. For this reason, Glenair supports every popular shield termination method with the full range of shell sizes, materials, platings and tooling, including:

- *Single and Multiple Conical Rings*
- *Crimp Rings*
- *Banding Terminations*
- *Castellated or Splined Rings*
- *Lampbase Thread Rings*
- *Radial Compression Springs*
- *Integrated Shield Socks*
- *Magnaforming*
- *Tinel™ Lock-Rings*

Customer selection depends on many factors, including cost, repairability, shield type and construction, cable diameter and type, cable jacket thickness, weight, shock and vibration, strain-relief, corrosion resistance and so on. The primary factor is cable construction: what type of shield is being terminated, where the shield or combination of shields is located within the cable or wire bundle, and how difficult the outer jacket is to work with. Customer preference, established methods and practices, tradition, manual skill levels and inspection procedures must also be considered.

The relative effectiveness of each style can be measured using a transfer impedance test. The transfer impedance test is the most widely accepted absolute measure of a shield's performance. It is used to evaluate cable shield performance against electrostatic discharge and radiated emissions coupling at frequency ranges up to 1 GHz. This testing method is recommended by the International Electrotechnical Commission as well as the military. Test reports for most standard termination technologies are available upon request from the factory.

Corrosion Protection in Electromagnetic Interconnect Systems

Glenair has a responsibility to deliver interconnect systems and hardware to its customers without "built-in" corrosion problems. As part of this effort we have pioneered the use of composite ther-

Backshell-to-Connector Coupling

Glenair offers four different coupling styles to meet every application requirement:

Direct Coupling



Direct couplers thread directly onto the connector by rotating the entire part. A separate toothed follower provides backshell-to-connector grounding.

Rotatable Coupling

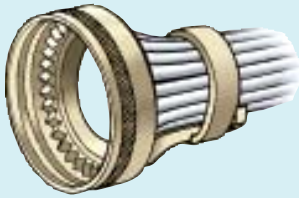

Rotatable designs utilize a free-spinning, toothed coupling nut for easier installation.

Self-Locking, Rotatable Coupling



Rotatable Self-Lockers add a ratcheted detent "clicker" to prevent de-coupling due to extreme vibration and shock.

Positive-Lock, Non-Detent Coupling



Glenair Mod Code -445 ("NESTOR") coupling mechanism corresponds to AS85049 style "N" non-detent, rotatable coupling with spring-loaded interface.

moplastic materials as an alternative to conductive metal materials and finishes. Composite products can eliminate corrosion problems completely in interconnect systems and should be considered for all harsh application environments.

The problems associated with corrosion are compounded by the need to produce parts which are electrically conductive. To prevent EMI from permeating into system electronics, conductive cable shielding is grounded to plated backshells and connectors to take the unwelcome EMI to earth. The challenge is to produce conductive, plated products which both prevent EMI and resist corrosion in harsh application environments. At Glenair this work takes place in three areas:

1. Strict attention to dissimilar metal combinations;
2. The specification of corrosion-resistant materials such as stainless steels and composites in severe environments wherever possible; and
3. The use of surface coatings such as nickel, zinc or gold plating to isolate base metals from reactive electrolytes.

The selection of compatible (non-galvanic) surface finishes is a critical step in backshell specification. To prevent dissimilar metal corrosion, customers should note material and finish specifications for connectors and cable shields before selecting connector accessory hardware. As a general rule, the backshell material and finish should match that of the chosen connector.

Electroless nickel plating (code M) provides a low resistance conductive finish appropriate for most H (magnetic) and E (electrical) field EMI applications, and is ideally suited for benign environments not exposed to salt-spray. For environmental applications, a sacrificial overplating, such as cadmium plate over electroless nickel (code NF), is recommended. Glenair zinc-nickel over electroless nickel (code ZN) may also be specified for environmental applications which require ASTM B 841-91 approval but are prohibited from using cadmium. Non-EMI applications may utilize nonconductive finishes such as Black Anodize (Code C). See Table II for other standard finish options.