

Motor Control

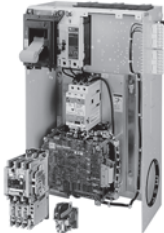
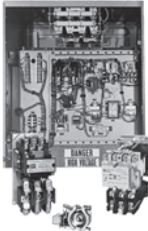
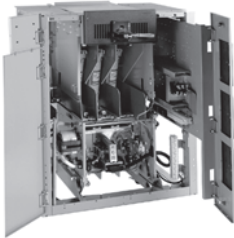

**13 Motor Control**

- Contactors, Starters and Brakes . . . . . **V12-T13-2**
- Adjustable Frequency AC Drives . . . . . **V12-T13-72**
- Synchronous . . . . . **V12-T13-76**
- Starters (Medium Voltage). . . . . **V12-T13-87**

#### Contents

<i>Description</i>	<i>Page</i>
<b>Pre 3-Star</b>	
Product History Time Line, Replacement Capabilities, Technology Upgrades . . . . .	<b>V12-T13-4</b>
<b>3-Star</b>	
Product History Time Line, Replacement Capabilities, Technology Upgrades . . . . .	<b>V12-T13-5</b>
<b>Citation</b>	
Product History Time Line . . . . .	<b>V12-T13-6</b>
Replacement Capabilities . . . . .	<b>V12-T13-7</b>
<b>Type N</b>	
Product History Time Line, Replacement Capabilities, Technology Upgrades . . . . .	<b>V12-T13-22</b>
<b>A200</b>	
Product History Time Line, Replacement Capabilities . . . . .	<b>V12-T13-23</b>
Technology Upgrades . . . . .	<b>V12-T13-26</b>
<b>A202</b>	
Product History Time Line, Replacement Capabilities . . . . .	<b>V12-T13-33</b>
<b>V201 and V200</b>	
Replacement Capabilities . . . . .	<b>V12-T13-36</b>
<b>Freedom</b>	
Product Description, Product History Time Line . . . . .	<b>V12-T13-37</b>
Replacement Capabilities . . . . .	<b>V12-T13-38</b>
Technology Upgrades . . . . .	<b>V12-T13-46</b>
<b>IT. Electromechanical NEMA</b>	
Product Description, Product History Time Line, Replacement Capabilities, Technology Upgrades . . . . .	<b>V12-T13-47</b>
<b>IT. Electromechanical IEC</b>	
Product Description, Product History Time Line, Replacement Capabilities, Technology Upgrades . . . . .	<b>V12-T13-48</b>
<b>XT IEC Power Control</b>	
Product Description, Product History Time Line, Replacement Capabilities, . . . . .	<b>V12-T13-49</b>
<b>Advantage</b>	
Product Description, Product History Time Line, Replacement Capabilities, Technology Upgrades . . . . .	<b>V12-T13-51</b>
<b>Definite Purpose</b>	
Product History Time Line, Replacement Capabilities, Technology Upgrades . . . . .	<b>V12-T13-53</b>
<b>JF Autostarter</b>	
Product History Time Line, Replacement Capabilities, Technology Upgrades . . . . .	<b>V12-T13-56</b>
<b>ME and MD DC Contactors</b>	
Product Description, Product History, Product History Time Line, Replacement Capabilities . . . . .	<b>V12-T13-57</b>
Technology Upgrades . . . . .	<b>V12-T13-60</b>
<b>C80 Mill Type DC Contactors</b>	
Product Description, Product History Time Line, Replacement Capabilities, Technology Upgrades . . . . .	<b>V12-T13-61</b>

<i>Description</i>	<i>Page</i>
<b>511 AC and DC Brakes</b>	
Product Description, Product History Time Line, Replacement Capabilities, Technology Upgrades . . . . .	<b>V12-T13-63</b>
<b>DPM-Contactor</b>	
Product Description, Product History Time Line, Replacement Capabilities, Technology Upgrades . . . . .	<b>V12-T13-65</b>
<b>AVD-Contactor</b>	
Product Description, Product History, Product History Time Line, Replacement Capabilities, Technology Upgrades . . . . .	<b>V12-T13-66</b>
<b>D-Contactor</b>	
Product Description, Product History, Product History Time Line, Replacement Capabilities, Technology Upgrades . . . . .	<b>V12-T13-67</b>
<b>Reversing/Assignment Contactors</b>	
Product Description, Product History, Product History Time Line, Replacement Capabilities, Technology Upgrades . . . . .	<b>V12-T13-68</b>
<b>P- and S-Contactors</b>	
Product Description, Product History, Product History Time Line, Replacement Capabilities, Technology Upgrades . . . . .	<b>V12-T13-69</b>

#### Overview

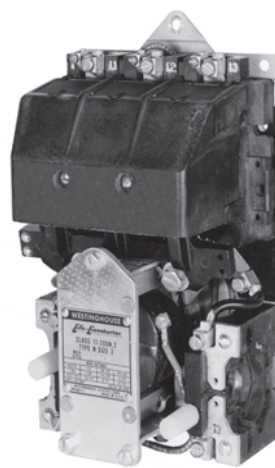

*Type N Contactor*

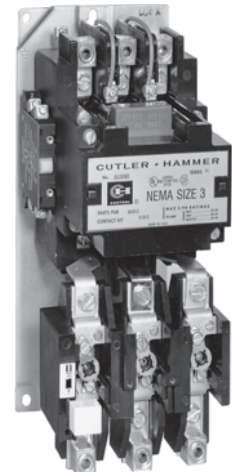

*Citation Starter*

#### Product Description

Cutler-Hammer® Starters and Contactors from Eaton's electrical business were and are designed to control functions of a connected motor by starting, stopping, reversing, regulating and protecting. When functions do not include speed regulation, this device is known as a starter rather than a controller.

Applications for starter functions are fans, pumps, constant horsepower, constant or variable torque machine tools, constant torque metalworking machinery, variable torque and horsepower fans and blowers, constant power heating, lighting, pumps and motors for all types of applications.

**Product History**



**Freedom**

The Cutler-Hammer line of contactors and starters dates back to the early 1920s in Milwaukee, WI. Changes in coil construction, making the first moisture-proof vacuum with impregnated coils, were innovations in this line of contactors and starters manufactured before the 3-Star line (now known as the Pre 3-Star). Eutectic alloy overloads were used later in this design with the design change to the 3-Star line. A few of the new features of the 3-Star line of contactors and starters were the first standard three-coil overload relays, new molding compounds, new metals and cast resin coils.



**A200**

The Type F magnetic contactor is the first magnetically controlled contactor in our Westinghouse® records. It was open in design, simple in construction and was state-of-the-art due to its magnetically controlled armature. The Type F contactor was replaced by the DE-ION® contactor, which featured the Westinghouse trademark DE-ION arc quenching. The DE-ION was followed by the Type DN, Type N and the Type A, today known as the A200. The Type B was developed in the late 1970s and was obsoleted two or three years later. The A200 open control is still a current offering. Prior to 1985, some of the larger sizes (5–9) were known as GCA and GCD.

The Citation line of contactors and starters was introduced in 1968 with many new features: the new CI non-wearing totally enclosed permanent air gap magnet structure; dual wound magnet coil with plug-in feature; color coded, twin break dust-safe contacts; and straight-through wiring. Although the Citation line was obsoleted in 1997, replacement contact kits, magnet coils and heater coils will continue to be available.

Today, the Freedom™ contactor, launched in 1986, is the flagship NEMA offering while **XT** is the IEC offering.

#### Pre 3-Star

*Originally a Cutler-Hammer Product*

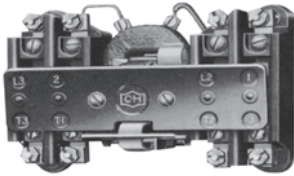

**Size 1 Contactor**

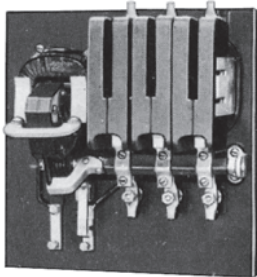

**Size 2 Contactor**

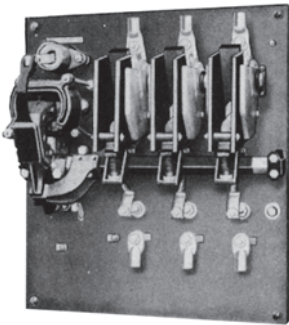

**Size 5 Contactor**

Parts are no longer available for Pre-3 Star.

#### Product History Time Line for Pre 3-Star, Bulletin 9586 ①

Size	1920	1940	1960	1980	2000	Present
Sizes 00 – 5	[Shaded bar]					

#### Replacement Capabilities

There are no replacement parts available. Replace with new contactor or starter.

#### Technology Upgrades

Size 00–3—Freedom  
 Sizes 4–5—Freedom

#### Note

① For all NEMA® rated starters, please contact Standard Open Control Aftermarket at **1-800-535-8992**.

**3-Star**

*Originally a Cutler-Hammer Product*

**Product History Time Line for 3-Star, Bulletin 9560, 9586, 9589, 9591, 9556, 9658, 9736 and 9739** ①

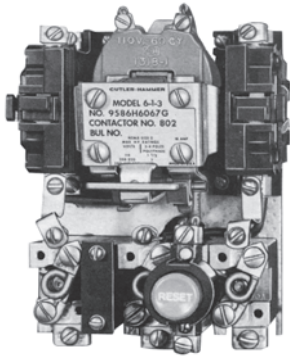

*Typical Size 0—Starter*

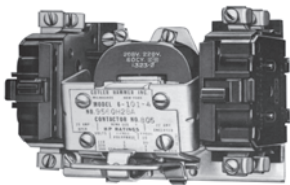

*Typical Size 1—Contactor*

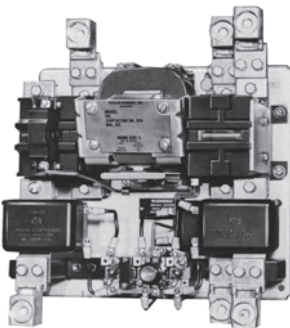

*Typical Size 5—Starter*

Size	1950	1955	1960	1965	1970	1975	1985	2000	Present
Size 0		████████████████████	████████████████████	████████████████████	████████████████████	████████████████████			
Size 1		████████████████████	████████████████████	████████████████████	████████████████████	████████████████████			
Size 2			████████████████████	████████████████████	████████████████████	████████████████████			
Size 3				████████████████████	████████████████████	████████████████████			
Size 4					████████████████████	████████████████████			
Size 5							████████████████████	████████████████████	████████████████████

**Replacement Capabilities**

There are no replacement parts available. Replace with new contactor or starter.

**Technology Upgrades**

Sizes 00–3—Freedom  
 Sizes 4–5—Freedom

**Note**

① For all NEMA rated Bulletin 9586 starters, please contact Standard Open Control Aftermarket at **1-800-535-8992**.

#### Citation

Originally a Cutler-Hammer Product

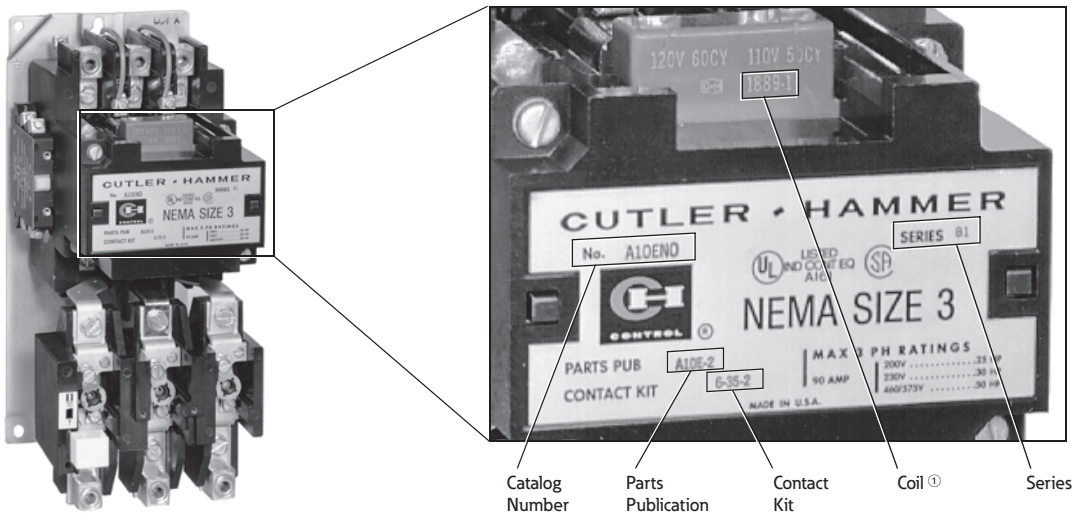

Citation Starter and Nameplate

#### Product History Time Line for Citation A10, A11, A13, A30, A31, A40, A41, A50, A51, A70, A71, A80, A81, B10, B11, B50, B51, B52, C10, C30 and C50

NEMA Size	Series	1965	1970	1975	1980	1985	1990	1995	2000	Present
Size 00	A1		████████████████████							
	B1					████████████████████				
	C1						████████████████████			
	D1							████████████████████		
Size 0	A1	████████████████████	████████████████████	████████████████████	████████████████████	████████████████████	████████████████████	████████████████████		
	B1									
Size 1	A1	████████████████████	████████████████████	████████████████████	████████████████████	████████████████████	████████████████████	████████████████████		
	B1									
Size 2	A1	████████████████████	████████████████████	████████████████████	████████████████████	████████████████████	████████████████████	████████████████████		
	B1									
Size 3	A1	████████████████████	████████████████████	████████████████████	████████████████████	████████████████████	████████████████████	████████████████████		
	B1									
Size 4	A1	████████████████████	████████████████████	████████████████████	████████████████████	████████████████████	████████████████████	████████████████████		
	B1									
Size 5	A1									
	B1									
Size 6	A1			████████████████████	████████████████████	████████████████████	████████████████████	████████████████████		
	B1									
	C1									
Size 7	A1		████████████████████	████████████████████	████████████████████	████████████████████	████████████████████	████████████████████		
	B1									
Size 8	A1		████████████████████	████████████████████	████████████████████	████████████████████	████████████████████	████████████████████		
	B1									

**Note**

① Although the number “9” is not imprinted on the coil, it must be used when ordering. For example, the proper ordering number for a 120V, 60 Hz, AC magnet coil would be 9-1887-1 (refer to the style numbers on **Page V12-T13-7**).

Replacement Capabilities

Replacement Capabilities—Contacts and Coils

Description	Coil Suffix	Style and Part Numbers									
		Size 00 Series A1 ①	Size 00 Series B1	Size 00 Series C1	Size 00 Series D1	Size 0	Size 1	Size 2 Series A1	Size 2 Series B1	Size 3 Series A1	Size 3 Series B1
<b>Contact Kits</b>											
Part number on contactor or starter nameplate											
Two-pole without interlock	—	6-21	②	②	②	6-22	6-23	6-24	6-34	6-25	6-35
Three-pole without interlock	—	6-21-2	②	②	②	6-22-2	6-23-2	6-24-2	6-34-2	6-25-2	6-35-2
Three-pole with interlock	—	6-21-3	②	②	—	—	—	—	—	—	—
Four-pole without interlock	—	—	—	—	—	6-22-3	6-23-3	—	6-34-3	—	—
Five-pole without interlock	—	—	—	—	—	6-22-4	6-23-4	—	6-34-4	—	—
<b>Magnet Coils</b>											
120V, 60 Hz or 110V, 50 Hz	A	9-1945-1	9-2183-1	9-2650-1	9-2823-1	9-1887-1	9-1887-1	9-1889-1	9-2526-1	9-1891-1	9-1889-1
240V, 60 Hz or 220V, 50 Hz	B	9-1945-2	9-2183-2	9-2650-2	9-2823-2	9-1887-2	9-1887-2	9-1889-2	9-2526-2	9-1891-2	9-1889-2
480V, 60 Hz or 440V, 50 Hz	C	9-1945-3	9-2183-5	9-2650-3	9-2823-3	9-1887-3	9-1887-3	9-1889-3	9-2526-3	9-1891-3	9-1889-3
600V, 60 Hz or 550V, 50 Hz	D	9-1945-4	9-2183-19	9-2650-4	9-2823-4	9-1887-4	9-1887-4	9-1889-4	9-2526-4	9-1891-4	9-1889-4
208V, 60 Hz	E	9-1945-5	9-2183-17	9-2650-5	9-2823-5	9-1887-5	9-1887-5	9-1889-13	9-2526-5	9-1891-13	9-1889-13
24V, 60 Hz	T	9-1945-8	9-2183-16	9-2650-7	9-2823-18	9-1887-7	9-1887-7	9-1889-20	9-2526-6	9-1891-15	9-1889-20
380V, 50 Hz	L	9-1945-6	9-2183-3	9-2650-6	9-2421-18 ③	9-1887-8	9-1887-8	9-1889-14	9-2526-7	9-1891-14	9-1889-14
277V, 60 Hz	H	9-1945-16	9-2183-18	9-2650-13	9-2823-12 9-2823-17	9-1887-16	9-1887-16	9-1889-31	9-2526-15	9-1891-26	9-1889-31
120 Vdc ④	A1	—	—	—	—	9-2024-2	9-2024-2	9-2025-2	9-2626-2	9-2026-2	9-2025-2
240 Vdc ④	B1	—	—	—	—	9-2024-1	9-2024-1	9-2025-1	9-2626-1	9-2026-1	9-2025-1
24 Vdc ④	T1	—	—	—	—	9-2024-4	9-2024-4	9-2025-4	9-2626-4	9-2026-4	9-2025-4
48 Vdc ④	W1	—	—	—	—	9-2024-3	9-2024-3	9-2025-3	9-2626-3	9-2026-3	9-2025-3

Replacement Capabilities—Contacts and Coils, continued

Description	Coil Suffix	Style and Part Numbers									
		Size 4 Series A1	Size 4 Series B1	Size 5	Size 6 Series A1	Size 6 Series B1	Size 6 Series C1	Size 7 Series A1	Size 7 Series B1	Size 8 Series A1	Size 8 Series B1
<b>Contact Kits</b>											
Part number on contactor or starter nameplate											
Two-pole	—	6-26	6-36-3	6-27	6-28	—	6-601-2	6-28	—	—	—
Three-pole	—	6-26-2	6-36-4	6-27-2	6-28-2	6-570	6-601	6-28-2	6-570	646C829G05	6-571
<b>Magnet Coils</b>											
120V, 60 Hz or 110V, 50 Hz	A	9-1891-1	9-1891-1	9-1891-1	9-1875-1	9-2651	9-2698	9-1875-1	9-2651	438C805G12	9-2654
240V, 60 Hz or 220V, 50 Hz	B	9-1891-2	9-1891-2	9-1891-2	9-1875-2	9-2651-2	9-2698-2	9-1875-2	9-2651-2	438C805G11	9-2654-2
480V, 60 Hz or 440V, 50 Hz	C	9-1891-3	9-1891-3	9-1891-3	9-1875-3	9-2651-3	9-2698-3	9-1875-3	9-2651-3	438C805G10	9-2654-3
600V, 60 Hz or 550V, 50 Hz	D	9-1891-4	9-1891-4	9-1891-4	9-1875-4	9-2651-4	9-2698-4	9-1875-4	9-2651-4	—	9-2654-4
208V, 60 Hz	E	9-1891-13	9-1891-13	9-1891-13	9-1875-14	9-2651-6	9-2698-5	9-1875-14	9-2651-6	438C805G11	9-2654-6
24V, 60 Hz	T	9-1891-15	9-1891-15	9-1891-15	—	—	—	—	—	—	—
380V, 50 Hz	L	9-1891-14	9-1891-14	9-1891-14	—	9-2651-5	9-2698-6	—	9-2651-5	438C805G15	9-2654-5
277V, 60 Hz	H	9-1891-26	9-1891-26	9-1891-26	—	—	—	—	—	—	—
120 Vdc ④	A1	9-2026-2	9-2026-2	9-2026-2	—	—	—	—	—	—	—
240 Vdc ④	B1	9-2026-1	9-2026-1	9-2026-1	—	—	—	—	—	—	—
24 Vdc ④	T1	9-2026-4	9-2026-4	9-2026-4	—	—	—	—	—	—	—
48 Vdc ④	W1	9-2026-3	9-2026-3	9-2026-3	—	—	—	—	—	—	—

Notes

- ① Citation overload relays are no longer available. A Freedom overload may be an option. Contact Control Aftermarket at 1-800-535-8992.
- ② Replace complete contactor.
- ③ Non-encapsulated coil.
- ④ For use in existing DC operated devices. Not for conversion of existing AC operated devices to DC.

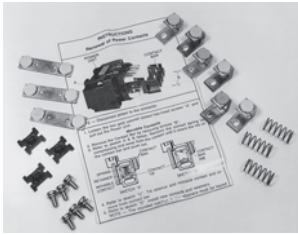

Three-Pole Contact Kit, Size 3, Series B1

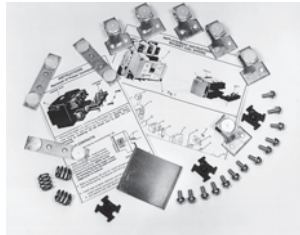

Three-Pole Contact Kit, Size 5



Magnet Coil, 120V/60 Hz for Size 3, Series A1

#### Replacement Capabilities—Overload Relays

Description	Style and Part Numbers									
	Size 00 Series A1	Size 00 Series B1	Size 00 Series C1	Size 00 Series D1	Size 0	Size 1	Size 2 Series A1	Size 2 Series B1	Size 3 Series A1	Size 3 Series B1
<b>Overload Relays</b>										
Without mounting plates— for replacement on existing starters										
Standard trip (Class 20)	①	①	①	①	①	①	①	①	①	①
Eutectic — 1 Element										
3 Element										
3 Element with alarm circuit										
Slow trip (Class 30)	①	①	①	①	①	①	①	①	①	①
Eutectic — 1 Element										
3 Element										
<b>Replacement Thermal Elements</b>										
Standard trip eutectic	②	②	②	②	②	②	②	②	②	②
Slow trip eutectic	10-5018 ③	10-5018 ③	10-5018 ③	10-5018 ③	10-5018 ③	10-5018 ③	10-5018 ③	10-5018 ③	10-5018 ③	10-5018 ③

#### Replacement Capabilities—Overload Relays, continued

Description	Style and Part Numbers									
	Size 4 Series A1	Size 4 Series B1	Size 5	Size 6 Series A1	Size 6 Series B1	Size 6 Series C1	Size 7 Series A1	Size 7 Series B1	Size 8 Series A1	Size 8 Series B1
<b>Overload Relays</b>										
Without mounting plates— for replacement on existing starters										
Standard trip (Class 20)	①	①	①	①	①	①	①	①	①	①
Eutectic — 1 Element										
3 Element										
3 Element with alarm circuit										
<b>Replacement Thermal Elements</b>										
Standard trip eutectic	②	②	②	②	②	②	②	②	②	②
Slow trip eutectic	10-5018 ③	10-5018 ③	10-5018 ③	—	—	—	—	—	—	—
Current transformer	—	—	—	—	42-3418-3 ④	42-3418-3 ④	—	—	—	—

#### Technology Upgrades

Sizes 00–3—Freedom  
 Sizes 4–6—Freedom  
 Sizes 7–8—Freedom

#### Adapter Plates

The adapter plates make it possible to replace a Citation starter with a Freedom starter and the same mounting holes can be used.

#### Notes

- ① Citation overload relays are no longer available. Replace with up-to-date starter, or contact Standard Open Control Aftermarket at **1-800-535-8992** to determine Freedom overload relay compatibility.
- ② No longer available. Replace with up-to-date overload relay or starter.
- ③ Will no longer be available once stock is depleted. If stock is out, replace with up-to-date overload relay or starter.
- ④ On Vista; no price.

#### Adapter Plates Ordering Information

NEMA Size	Adapter Plate Catalog Number Freedom
00, 0	C321CMP0
1	C321CMP1
2	C321CMP2
3	C321CMP3
4	C321CMP4
5	C321CMP5



**Heaters**

Overload relays do not include heaters. Please see table for heater element index.

**Heater Selection**

**For Replacement in Existing Applications Only**

Heaters are rated to protect 40°C rise of motors; and, open and drip-proof motors having a service factor of 1.15 where the motor and the controller are at the same ambient temperature.

For other conditions:

1. For 50°C, 55°C and 75°C (122°F, 131°F and 167°F) rise motors and enclosed motors having a service factor of 1.0, select one size smaller.
2. Ambient temperature of the starter lower than the motor by 26°C (79°F), use one size smaller.
3. Ambient temperature of the starter higher than the motor by 26°C (79°F), use one size larger.

Ultimate tripping current of heaters is approximately 1.25 times the minimum current rating listed in the tables.

**Heater Selection Index**

**Note:** Use this index to cross-reference tables on **Pages V12-T13-9 through V12-T13-21.**

**Index of Overload Relay Heater Selection Tables**

Starter Type Catalog Prefix	Type	Heater Selection Table Number NEMA Size of Starter							
		00-0-1 (1-1/2)	2	3	4	5	6	7	8
<b>A10</b>	Open	ST-1	ST-3	ST-5	ST-7	ST-16	ST-10	ST-11	ST-12
	Enclosed	ST-2	ST-4	ST-6	ST-7	ST-16	ST-10	ST-11	ST-12
<b>A11</b>	Open	BNC-1	BNC-3	BNC-5	BNC-7	BNC-9	—	—	—
	Enclosed	BNC-2	BNC-4	BNC-6	BNC-7	BNC-9	—	—	—
<b>A13</b>	Open	LT-2	LT-4	LT-6	LT-7	LT-8	—	—	—
	Enclosed	LT-1	LT-3	LT-5	LT-7	LT-8	—	—	—
<b>A30 and A40</b>	Enclosed	ST-9	ST-3	ST-6	ST-7	ST-16	ST-10	ST-11	ST-12
<b>A31 and A41</b>	Enclosed	BNC-8	BNC-3	BNC-6	BNC-7	BNC-9	—	—	—
<b>A50</b>	Open	ST-1	ST-3	ST-5	ST-7	ST-16	ST-10	ST-11	ST-12
	Enclosed	ST-2	ST-4	ST-6	ST-7	ST-16	ST-10	ST-11	ST-12
<b>A51</b>	Open	BNC-1	BNC-3	BNC-5	BNC-7	BNC-9	—	—	—
	Enclosed	BNC-2	BNC-4	BNC-6	BNC-7	BNC-9	—	—	—
<b>A70 and A80</b>	Enclosed	ST-9	ST-3	ST-6	ST-7	ST-16	ST-10	ST-11	ST-12
<b>A71 and A81</b>	Enclosed	BNC-8	BNC-3	BNC-5	BNC-7	BNC-9	—	—	—
<b>A400-A420</b>	Enclosed	—	—	ST-14	ST-15	ST-16	ST-10	ST-11	ST-12
<b>A460</b> ①	Enclosed	ST-2 ①	ST-4 ①	ST-6 ①	ST-7 ①	ST-16 ①	ST-10 ①	ST-11 ①	ST-12 ①
<b>A490</b> ②	Enclosed	ST-2 ②	ST-4 ②	ST-6 ②	ST-7 ②	ST-16 ②	ST-10 ②	ST-11 ②	ST-12 ②
<b>A700</b>	Open	ST-1	ST-3	ST-5	ST-7	ST-16	—	—	—
	Enclosed	ST-2	ST-4	ST-6	ST-7	ST-16	ST-10	—	—
<b>A800-A803</b>	Enclosed	ST-9	ST-3	ST-5	ST-7	ST-16	ST-10	ST-11	—
<b>A804-A806</b>	Enclosed	ST-9	ST-3	ST-5	—	—	—	—	—
<b>A808-A809</b>	Enclosed	—	ST-13	ST-5	ST-5	—	—	—	—
<b>B10 and B50</b>	Enclosed	ST-1	ST-3	ST-5	ST-7	—	—	—	—
<b>B11 and B51</b>	Open	BNC-1	—	—	—	—	—	—	—
	Enclosed	BNC-2	BNC-3	BNC-5	—	—	—	—	—
<b>C300</b>	Open and enclosed	ST-1	ST-3	ST-5	ST-7	—	—	—	—
<b>C301</b>	Open and enclosed	BNC-1	BNC-4	BNC-5	BNC-7	—	—	—	—
<b>C303</b>	Open and enclosed	LT-2	LT-4	LT-6	LT-7	—	—	—	—

**Notes**

① Select heaters for 50% of rated full load current.

② Select heaters for 68% of rated full load current.

Individually boxed heaters master packed 10 per carton.

## Overload Relay Heater Selection Tables

## Type ST Standard Trip Eutectic Alloy

For replacement in existing applications only; for motors with 1.15 service factor.

Table ST-1 NEMA Sizes 00, 0, 1, 1-1/2 For <i>Open Type</i> Catalog Prefix A10, A50, A700, B10, B50, C300 For <i>Enclosed Type</i> Catalog Prefix B10, B50, C300 Heater Ampere Range	Table ST-2 NEMA Sizes 00, 0, 1, 1-1/2 For <i>Enclosed Type</i> Catalog Prefix A10, A50, A460 <sup>①</sup> , A490 <sup>②</sup> , A700	Table ST-3 NEMA Size 2 For <i>Open Type</i> Catalog Prefix A10, A50, A700, B10, C300 For <i>Enclosed Type</i> Catalog Prefix B10, C300, A30, A40, A70, A80, A800-A803	Table ST-4 NEMA Size 2 For <i>Enclosed Type</i> Catalog Prefix A10, A50, A460 <sup>①</sup> , A490 <sup>②</sup> , A700	Table ST-5 NEMA Size 3 For <i>Open Type</i> Catalog Prefix A10, A50, A700, B10, C300 For <i>Enclosed Type</i> Catalog Prefix A70, A80, A800-A803, A808-A809, B10	Heater Catalog Number
0.167–0.187	0.155–0.173	—	—	—	H1101
0.188–0.210	0.174–0.195	—	—	—	H1102
0.211–0.237	0.196–0.220	—	—	—	H1103
0.238–0.266	0.221–0.247	—	—	—	H1104
0.267–0.298	0.248–0.278	—	—	—	H1105
0.299–0.334	0.279–0.310	—	—	—	H1106
0.335–0.376	0.311–0.349	—	—	—	H1107
0.377–0.422	0.350–0.391	—	—	—	H1108
0.423–0.474	0.392–0.441	—	—	—	H1109
0.475–0.532	0.442–0.495	—	—	—	H1110
0.533–0.598	0.496–0.555	—	—	—	H1111
0.599–0.672	0.556–0.624	—	—	—	H1112
0.673–0.757	0.625–0.703	—	—	—	H1113
0.758–0.855	0.704–0.795	—	—	—	H1114
0.865–0.959	0.796–0.895	—	—	—	H1115
0.960–1.07	0.896–0.999	—	—	—	H1116
1.08–1.21	1.00–1.12	—	—	—	H1117
1.22–1.35	1.13–1.25	—	—	—	H1018
1.36–1.52	1.26–1.41	—	—	—	H1019
1.53–1.70	1.42–1.58	—	—	—	H1020
1.71–1.90	1.59–1.77	—	—	—	H1021
1.91–2.10	1.78–1.96	—	—	—	H1022
2.11–2.33	1.97–2.17	—	—	—	H1023
2.34–2.62	2.18–2.44	—	—	—	H1024
2.63–2.93	2.45–2.72	—	—	—	H1025
2.94–3.27	2.73–3.04	—	—	—	H1026
3.28–3.64	3.05–3.38	—	—	—	H1066
3.65–4.06	3.39–3.73	3.72–4.10	—	—	H1027
4.07–4.55	3.74–4.18	4.11–4.59	3.86–4.31	—	H1028
4.56–5.03	4.19–4.63	4.60–5.07	4.32–4.77	—	H1029

## Notes

① For A460 controllers, select heaters at 50% of rated full load current.

② For A490 controllers, select heaters at 58% of rated full load current.

Individually boxed heaters master packed 10 per carton.

**Type ST Standard Trip Eutectic Alloy, continued**

For replacement in existing applications only; for motors with 1.15 service factor.

<b>Table ST-1</b> NEMA Sizes 00, 0, 1, 1-1/2 For <i>Open Type</i> Catalog Prefix A10, A50, A700, B10, B50, C300 For <i>Enclosed Type</i> Catalog Prefix B10, B50, C300 Heater Ampere Range	<b>Table ST-2</b> NEMA Sizes 00, 0, 1, 1-1/2 For <i>Enclosed Type</i> Catalog Prefix A10, A50, A460 <sup>①</sup> , A490 <sup>②</sup> , A700	<b>Table ST-3</b> NEMA Size 2 For <i>Open Type</i> Catalog Prefix A10, A50, A700, B10, C300 For <i>Enclosed Type</i> Catalog Prefix B10, C300, A30, A40, A70, A80, A800-A803	<b>Table ST-4</b> NEMA Size 2 For <i>Enclosed Type</i> Catalog Prefix A10, A50, A460 <sup>①</sup> , A490 <sup>②</sup> , A700	<b>Table ST-5</b> NEMA Size 3 For <i>Open Type</i> Catalog Prefix A10, A50, A700, B10, C300 For <i>Enclosed Type</i> Catalog Prefix A70, A80, A800-A803, A808-A809, B10	Heater Catalog Number
5.04–5.59	4.64–5.15	5.08–5.65	4.78–5.31	—	H1030
5.60–6.25	5.16–5.68	5.66–6.29	5.32–5.90	—	H1031
6.26–6.92	5.69–6.30	6.30–7.00	5.91–6.55	—	H1032
6.93–7.75	6.31–7.05	7.01–7.82	6.56–7.33	—	H1033
7.76–8.63	7.06–7.76	7.83–8.79	7.34–8.15	8.32–9.27	H1034
8.64–9.59	7.77–8.63	8.80–9.67	8.16–9.03	9.28–10.1	H1035
9.60–10.6	8.64–9.51	9.68–10.8	9.04–10.1	10.2–11.4	H1036
10.7–11.9	9.52–10.5	10.9–12.0	10.2–11.2	11.5–12.8	H1037
12.0–13.3	10.6–11.8	12.1–13.4	11.3–12.5	12.9–14.3	H1038
13.4–14.7	11.9–13.1	13.5–14.9	12.6–13.9	14.4–16.0	H1039
14.8–16.6	13.2–14.8	15.0–17.6	14.0–15.7	16.1–17.8	H1040
16.7–18.8	14.9–16.7	17.7–19.0	15.8–17.5	17.9–20.3	H1041
18.9–21.2	16.8–18.9	19.1–21.5	17.6–19.8	20.4–22.9	H1042
21.3–23.9	19.0–21.3	21.6–24.5	19.9–22.3	23.0–26.0	H1043
24.0–27.0	21.4–24.1	24.6–27.9	22.4–25.4	26.1–29.5	H1044
—	24.2–27.0	28.0–32.0	25.5–28.7	29.6–33.5	H1045
—	—	32.1–36.6	28.8–32.5	33.6–37.8	H1046
—	—	36.7–41.8	32.6–36.6	37.9–42.8	H1047
—	—	41.9–45.0	36.7–41.0	42.9–48.5	H1048
—	—	—	41.1–45.0	48.6–55.1	H1049
—	—	—	—	55.2–62.3	H1050
—	—	—	—	62.4–69.5	H1051
—	—	—	—	69.6–79.1	H1052
—	—	—	—	79.2–90.0	H1054
—	—	—	—	—	H1055
—	—	—	—	—	H1056
—	—	—	—	—	H1057
—	—	—	—	—	H1058

**Notes**

① For A460 controllers, select heaters at 50% of rated full load current.

② For A490 controllers, select heaters at 58% of rated full load current.

Individually boxed heaters master packed 10 per carton.

#### Type ST Standard Trip Eutectic Alloy, continued

For replacement in existing applications only; for motors with 1.15 service factor.

Table ST-6 NEMA Size 3	Table ST-7 NEMA Size 4	Table ST-8 NEMA Size 5	Table ST-9 NEMA Size 0 and 1	Table ST-10 NEMA Size 6	Heater Catalog Number
For <i>Enclosed Type</i> Catalog Prefix A10, A30, A40, A50, A460 <sup>①</sup> , A490 <sup>②</sup> , A700	For <i>Open Type</i> Catalog Prefix A10, A50, C300 For <i>Enclosed Type</i> Catalog Prefix A10, A30, A40, A50, A70, A80, A460 <sup>①</sup> , A490 <sup>②</sup> , A700, A800-A803	For <i>Open and Enclosed</i> Catalog Prefix A10, A50, A30-40, A70, A80, A400, A410, A420, A460, A490, A800-A801	For <i>Enclosed Type</i> Catalog Prefix A30, A40, A70, A80, A800-A803	For <i>Open Type</i> Catalog Prefix A10, A50, A700 For <i>Enclosed Type</i> Catalog Prefix A10, A30, A40, A50, A70, A80, A400, A460 <sup>①</sup> , A490 <sup>②</sup> , A700	
Heater Ampere Range					
—	—	—	0.164–0.183	—	H1101
—	—	—	0.184–0.205	—	H1102
—	—	—	0.206–0.232	—	H1103
—	—	—	0.233–0.260	—	H1104
—	—	—	0.261–0.293	—	H1105
—	—	—	0.294–0.328	—	H1106
—	—	—	0.329–0.369	—	H1107
—	—	—	0.370–0.414	—	H1108
—	—	—	0.415–0.465	—	H1109
—	—	—	0.466–0.522	—	H1110
—	—	—	0.523–0.586	—	H1111
—	—	—	0.587–0.659	—	H1112
—	—	—	0.660–0.743	—	H1113
—	—	—	0.744–0.839	—	H1114
—	—	—	0.840–0.943	—	H1115
—	—	—	0.944–1.05	—	H1116
—	—	—	1.06–1.17	—	H1117
—	—	—	1.18–1.31	—	H1018
—	—	—	1.32–1.47	154–171	H1019
—	—	92–101	1.48–1.66	172–192	H1020
—	—	102–113	1.67–1.85	193–215	H1021
—	—	114–125	1.86–2.04	216–237	H1022
—	—	126–139	2.05–2.26	238–263	H1023
—	—	140–157	2.27–2.54	264–295	H1024
—	—	158–175	2.55–2.85	296–330	H1025
—	—	176–196	2.86–3.18	331–369	H1026
—	—	197–218	3.19–3.53	370–410	H1066
—	—	219–243	3.54–3.95	411–458	H1027
—	—	244–270	3.96–4.41	459–512	H1028
—	—	—	4.42–4.88	513–574	H1029

#### Notes

① For A460 controllers, select heaters for 50% of rated full load current.

② For A490 controllers, select heaters for 58% of rated full load current.

Individually boxed heaters master packed 10 per carton.

**Type ST Standard Trip Eutectic Alloy, continued**

For replacement in existing applications only; for motors with 1.15 service factor.

Table ST-6 NEMA Size 3	Table ST-7 NEMA Size 4	Table ST-8 NEMA Size 5	Table ST-9 NEMA Size 0 and 1	Table ST-10 NEMA Size 6	Heater Catalog Number
For Enclosed Type Catalog Prefix A10, A30, A40, A50, A460 ①, A490 ②, A700	For Open Type Catalog Prefix A10, A50, C300 For Enclosed Type Catalog Prefix A10, A30, A40, A50, A70, A80, A460 ①, A490 ②, A700, A800-A803	For Open and Enclosed Catalog Prefix A10, A50, A30-40, A70, A80, A400, A410, A420, A460, A490, A800-A801	For Enclosed Type Catalog Prefix A30, A40, A70, A80, A800-A803	For Open Type Catalog Prefix A10, A50, A700 For Enclosed Type Catalog Prefix A10, A30, A40, A50, A70, A80, A400, A460 ①, A490 ②, A700	
Heater Ampere Range					
—	—	—	4.89–5.42	—	H1030
—	—	—	4.89–5.42	—	H1031
—	—	—	6.08–6.64	—	H1032
—	—	—	6.65–7.43	—	H1033
8.24–9.19	—	—	7.44–8.23	—	H1034
9.20–10.1	—	—	8.24–9.19	—	H1035
10.2–11.3	—	—	9.20–10.1	—	H1036
11.4–12.7	—	—	10.2–11.3	—	H1037
12.8–14.1	—	—	11.4–12.6	—	H1038
14.2–15.8	—	—	12.7–14.0	—	H1039
15.9–17.7	—	—	14.1–15.7	—	H1040
17.8–20.1	—	—	15.8–17.7	—	H1041
20.2–22.7	20.6–23.3	—	17.8–19.8	—	H1042
22.8–25.5	23.4–26.3	—	19.9–22.0	—	H1043
25.6–28.9	26.4–30.8	—	22.1–24.9	—	H1044
29.0–32.5	30.9–34.0	—	25.0–27.0	—	H1045
32.6–36.7	34.1–38.3	—	—	—	H1046
36.8–41.0	38.4–43.4	—	—	—	H1047
41.1–46.0	43.5–49.3	—	—	—	H1048
46.1–51.8	49.4–55.8	—	—	—	H1049
51.9–58.6	55.9–63.1	—	—	—	H1050
58.7–64.6	63.2–70.4	—	—	—	H1051
64.7–72.7	70.5–79.9	—	—	—	H1052
72.8–83.1	80.0–92.7	—	—	—	H1054

**Notes**

① For A460 controllers, select heaters for 50% of rated full load current.

② For A490 controllers, select heaters for 58% of rated full load current.

Individually boxed heaters master packed 10 per carton.

#### Type ST Standard Trip Eutectic Alloy, continued

For replacement in existing applications only; for motors with 1.15 service factor.

Table ST-11 NEMA Size 7 For <i>Open Type</i> Catalog Prefix A10, A50, A700 For <i>Enclosed Type</i> Catalog Prefix A10, A30, A40, A50, A70, A80, A400, A460 ①, A490 ②, A700 Heater Ampere Range	Table ST-12 NEMA Size 8 For <i>Open Type</i> Catalog Prefix A10, A50, A700 For <i>Enclosed Type</i> Catalog Prefix A10, A30, A40, A50, A70, A80, A400, A460 ①, A490 ②, A700	Table ST-13 NEMA Size 2 For <i>Enclosed Type</i> Catalog Prefix A808, A809	Table ST-14 NEMA Size 3 For <i>Enclosed Type</i> Catalog Prefix A400	Table ST-15 NEMA Size 4 For <i>Enclosed Type</i> Catalog Prefix A400	Heater Catalog Number
—	—	—	—	—	H1101
—	—	—	—	—	H1102
—	—	—	—	—	H1103
—	—	—	—	—	H1104
—	—	—	—	—	H1105
—	—	—	—	—	H1106
—	—	—	—	—	H1107
—	—	—	—	—	H1108
—	—	—	—	—	H1109
—	—	—	—	—	H1110
—	—	—	—	—	H1111
—	—	—	—	—	H1112
—	—	—	—	—	H1113
—	—	—	—	—	H1114
—	—	—	—	—	H1115
—	—	—	—	—	H1116
—	—	—	—	—	H1117
229–255	—	—	—	—	H1018
256–287	384–429	—	—	—	H1019
288–321	430–482	—	—	—	H1020
322–359	483–538	—	—	—	H1021
360–397	539–595	—	—	—	H1022
398–439	596–657	—	—	—	H1023
440–492	658–741	—	—	—	H1024
493–551	742–827	—	—	—	H1025
552–615	828–924	—	—	—	H1026
616–685	925–1027	—	—	—	H1066
686–763	1028–1147	—	—	—	H1027
764–855	1148–1285	3.89–4.35	—	—	H1028
—	—	4.36–4.81	—	—	H1029

#### Notes

- ① For A460 controllers, select heaters for 50% of rated full load current.
- ② For A490 controllers, select heaters for 58% of rated full load current.

Individually boxed heaters master packed 10 per carton.

**Type ST Standard Trip Eutectic Alloy, continued**

For replacement in existing applications only; for motors with 1.15 service factor.

Table ST-11 NEMA Size 7 For <i>Open Type</i> Catalog Prefix A10, A50, A700 For <i>Enclosed Type</i> Catalog Prefix A10, A30, A40, A50, A70, A80, A400, A460 ①, A490 ②, A700 Heater Ampere Range	Table ST-12 NEMA Size 8 For <i>Open Type</i> Catalog Prefix A10, A50, A700 For <i>Enclosed Type</i> Catalog Prefix A10, A30, A40, A50, A70, A80, A400, A460 ①, A490 ②, A700	Table ST-13 NEMA Size 2 For <i>Enclosed Type</i> Catalog Prefix A808, A809	Table ST-14 NEMA Size 3 For <i>Enclosed Type</i> Catalog Prefix A400	Table ST-15 NEMA Size 4 For <i>Enclosed Type</i> Catalog Prefix A400	Heater Catalog Number
—	—	4.82–5.35	—	—	H1030
—	—	5.36–5.96	—	—	H1031
—	—	5.97–6.63	—	—	H1032
—	—	6.64–7.41	—	—	H1033
—	—	7.42–8.23	7.84–8.71	—	H1034
—	—	8.24–9.19	8.72–9.67	—	H1035
—	—	9.20–10.2	9.68–10.8	—	H1036
—	—	10.3–11.4	10.9–12.0	—	H1037
—	—	11.5–12.8	12.1–13.5	—	H1038
—	—	12.9–14.1	13.6–15.0	—	H1039
—	—	14.2–15.9	15.1–16.8	—	H1040
—	—	16.0–18.1	16.9–19.1	—	H1041
—	—	18.2–20.4	19.2–21.6	19.5–21.9	H1042
—	—	20.5–23.3	21.7–24.5	22.0–24.7	H1043
—	—	23.4–26.5	24.6–27.8	24.8–29.0	H1044
—	—	26.6–30.3	27.9–31.5	29.1–31.9	H1045
—	—	30.4–34.7	31.6–35.5	32.0–36.1	H1046
—	—	34.8–39.6	35.6–40.3	36.2–40.7	H1047
—	—	39.7–45.0	40.4–45.6	40.8–46.2	H1048
—	—	—	45.7–51.8	46.3–52.4	H1049
—	—	—	51.9–58.6	52.5–59.2	H1050
—	—	—	58.7–65.2	59.3–66.3	H1051
—	—	—	65.3–74.3	66.4–75.1	H1052
—	—	—	74.4–86.3	75.2–87.1	H1054

**Notes**

- ① For A460 controllers, select heaters for 50% of rated full load current.
- ② For A490 controllers, select heaters for 58% of rated full load current.

Individually boxed heaters master packed 10 per carton.

**Type BNC Bimetal**

For replacement in existing applications only; for motors with 1.15 service factor.

<b>Table BNC-1</b> NEMA Sizes 00, 0, 1, 1-1/2 For <i>Open Type</i> Catalog Prefix A11, A51, B11, B51, C301 For <i>Enclosed Type</i> Catalog Prefix C301 Heater Ampere Range	<b>Table BNC-2</b> NEMA Sizes 00, 0, 1, 1-1/2 For <i>Enclosed Type</i> Catalog Prefix A11, A51, B11, B51	<b>Table BNC-3</b> NEMA Size 2 For <i>Open Type</i> Catalog Prefix A11, A51, B11, C301 For <i>Enclosed Type</i> Catalog Prefix A31, A41, A71, A81, B11	<b>Table BNC-4</b> NEMA Size 2 For <i>Enclosed Type</i> Catalog Prefix A11, A51, C301	Heater Catalog Number
0.180–0.201	0.167–0.187	—	—	H1101
0.202–0.226	0.188–0.210	—	—	H1102
0.227–0.254	0.211–0.236	—	—	H1103
0.255–0.285	0.237–0.266	—	—	H1104
0.286–0.320	0.267–0.297	—	—	H1105
0.321–0.357	0.298–0.332	—	—	H1106
0.358–0.402	0.333–0.373	—	—	H1107
0.403–0.451	0.374–0.419	—	—	H1108
0.452–0.506	0.420–0.470	—	—	H1109
0.507–0.568	0.471–0.528	—	—	H1110
0.569–0.638	0.529–0.592	—	—	H1111
0.639–0.716	0.593–0.663	—	—	H1112
0.717–0.799	0.664–0.743	—	—	H1113
0.800–0.911	0.744–0.847	—	—	H1114
0.912–1.01	0.848–0.951	—	—	H1115
1.02–1.14	0.952–1.06	—	—	H1116
1.15–1.29	1.07–1.20	—	—	H1117
1.30–1.44	1.21–1.33	—	—	H1018
1.45–1.61	1.34–1.49	—	—	H1019
1.62–1.80	1.50–1.67	—	—	H1020
1.81–2.03	1.68–1.89	—	—	H1021
2.04–2.25	1.90–2.09	—	—	H1022
2.26–2.49	2.10–2.32	—	—	H1023
2.50–2.76	2.33–2.57	—	—	H1024
2.77–3.05	2.58–2.83	—	—	H1025
3.06–3.39	2.84–3.15	—	—	H1026
3.40–3.83	3.16–3.51	3.87–4.18	—	H1066
3.84–4.22	3.52–3.87	4.19–4.60	3.94–4.33	H1027
4.23–4.63	3.88–4.25	4.61–5.10	4.34–4.78	H1028
4.64–5.19	4.26–4.76	5.11–5.60	4.79–5.27	H1029

**Note**

Individually boxed heaters master packed 10 per carton.



**Type BNC Bimetal**

For replacement in existing applications only; for motors with 1.15 service factor.

<b>Table BNC-1</b> NEMA Sizes 00, 0, 1, 1-1/2 For <i>Open</i> Type Catalog Prefix A11, A51, B11, B51, C301 For <i>Enclosed</i> Type Catalog Prefix C301 Heater Ampere Range	<b>Table BNC-2</b> NEMA Sizes 00, 0, 1, 1-1/2 For <i>Enclosed</i> Type Catalog Prefix A11, A51, B11, B51	<b>Table BNC-3</b> NEMA Size 2 For <i>Open</i> Type Catalog Prefix A11, A51, B11, C301 For <i>Enclosed</i> Type Catalog Prefix A31, A41, A71, A81, B11	<b>Table BNC-4</b> NEMA Size 2 For <i>Enclosed</i> Type Catalog Prefix A11, A51, C301	<b>Heater Catalog Number</b>
5.20–5.73	4.77–5.27	5.61–6.20	5.28–5.83	H1030
5.74–6.49	5.28–5.90	6.21–6.92	5.84–6.51	H1031
6.50–7.32	5.91–6.63	6.93–7.76	6.52–7.29	H1032
7.33–8.07	6.64–7.35	7.77–8.63	7.30–8.07	H1033
8.08–9.03	7.36–8.15	8.64–9.67	8.08–9.03	H1034
9.04–9.99	8.16–8.87	9.68–10.5	9.04–9.99	H1035
10.0–11.1	8.88–9.99	10.6–11.8	10.0–11.1	H1036
11.2–12.5	10.0–11.1	11.9–13.2	11.2–12.3	H1037
12.6–14.1	11.2–12.5	13.3–15.0	12.4–14.1	H1038
14.2–15.9	12.6–14.1	15.1–17.2	14.2–16.1	H1039
16.0–18.0	14.2–16.1	17.3–19.1	16.2–17.8	H1040
18.1–19.8	16.2–17.7	19.2–21.5	17.9–19.9	H1041
19.9–22.2	17.8–19.8	21.6–23.6	20.0–21.9	H1042
22.3–25.0	19.9–22.2	23.7–27.0	22.0–24.7	H1043
25.1–27.0	22.3–25.0	27.1–30.6	24.8–27.9	H1044
—	25.1–27.0	30.7–35.1	28.0–31.6	H1045
—	—	35.2–39.8	31.7–35.3	H1046
—	—	39.9–45.0	35.4–39.4	H1047
—	—	—	39.5–44.4	H1048
—	—	—	44.5–45.0	H1049
—	—	—	—	H1050
—	—	—	—	H1051
—	—	—	—	H1052
—	—	—	—	H1054
—	—	—	—	H1055
—	—	—	—	H1056
—	—	—	—	H1057
—	—	—	—	H1058

**Note**

Individually boxed heaters master packed 10 per carton.

#### Type BNC Bimetal, continued

For replacement in existing applications only; for motors with 1.15 service factor.

Table BNC-5 NEMA Size 3	Table BNC-6 NEMA Size 3	Table BNC-7 NEMA Size 4 For <i>Open</i> Type Catalog Prefix A11, A51, C301 For <i>Enclosed</i> Type Catalog Prefix A11, A31, A41, A51, A71, A81	Table BNC-8 NEMA Sizes 0 and 1	Table BNC-9 NEMA Size 5	Heater Catalog Number
For <i>Open</i> Type Catalog Prefix A11, B11, A51, C301 For <i>Enclosed</i> Type Catalog Prefix B11, A71, A81	For <i>Enclosed</i> Type Catalog Prefix A11, A31, A41, A51		For <i>Enclosed</i> Type Catalog Prefix A31, A41, A71, A81	For <i>Open</i> and <i>Enclosed</i> Type Catalog Prefix A11, A31-41, A51, A71, A81	
Heater Ampere Range					
—	—	—	0.176–0.198	—	H1101
—	—	—	0.199–0.221	—	H1102
—	—	—	0.222–0.249	—	H1103
—	—	—	0.250–0.279	—	H1104
—	—	—	0.280–0.313	—	H1105
—	—	—	0.314–0.350	—	H1106
—	—	—	0.351–0.395	—	H1107
—	—	—	0.396–0.442	—	H1108
—	—	—	0.443–0.497	—	H1109
—	—	—	0.498–0.556	—	H1110
—	—	—	0.557–0.626	—	H1111
—	—	—	0.627–0.703	—	H1112
—	—	—	0.704–0.783	—	H1113
—	—	—	0.784–0.895	—	H1114
—	—	—	0.896–0.999	—	H1115
—	—	—	1.00–1.12	—	H1116
—	—	—	1.13–1.25	—	H1117
—	—	—	1.26–1.40	—	H1018
—	—	—	1.41–1.56	—	H1019
—	—	—	1.57–1.74	96.8–108	H1020
—	—	—	1.75–1.97	109–121	H1021
—	—	—	1.98–2.19	122–135	H1022
—	—	—	2.20–2.42	136–149	H1023
—	—	—	2.43–2.68	150–166	H1024
—	—	—	2.69–2.95	167–182	H1025
—	—	—	2.96–3.29	183–203	H1026
—	—	—	3.30–3.72	204–229	H1066
—	—	—	3.73–4.10	230–253	H1027
—	—	—	4.11–4.49	254–283	H1028
—	—	—	4.50–5.04	—	H1029

**Note**

Individually boxed heaters master packed 10 per carton.

**Type BNC Bimetal, continued**

For replacement in existing applications only; for motors with 1.15 service factor.

<b>Table BNC-5</b> NEMA Size 3	<b>Table BNC-6</b> NEMA Size 3	<b>Table BNC-7</b> NEMA Size 4	<b>Table BNC-8</b> NEMA Sizes 0 and 1	<b>Table BNC-9</b> NEMA Size 5	
<i>For Open Type</i> Catalog Prefix A11, B11, A51, C301 <i>For Enclosed Type</i> Catalog Prefix B11, A71, A81	<i>For Enclosed Type</i> Catalog Prefix A11, A31, A41, A51	<i>For Open Type</i> Catalog Prefix A11, A51, C301 <i>For Enclosed Type</i> Catalog Prefix A11, A31, A41, A51, A71, A81	<i>For Enclosed Type</i> Catalog Prefix A31, A41, A71, A81	<i>For Open and Enclosed Type</i> Catalog Prefix A11, A31-41, A51, A71, A81	Heater Catalog Number
<b>Heater Ampere Range</b>					
—	—	—	5.05–5.56	—	H1030
—	—	—	5.57–6.23	—	H1031
—	—	—	6.24–7.03	—	H1032
7.57–8.47	7.57–8.39	—	7.04–7.75	—	H1033
8.48–9.35	8.40–9.27	—	7.76–8.71	—	H1034
9.36–10.1	9.28–10.1	—	8.72–9.59	—	H1035
10.2–11.2	10.2–11.1	—	9.60–10.5	—	H1036
11.3–12.2	11.2–12.1	—	10.6–11.8	—	H1037
12.3–13.7	12.2–13.6	—	11.9–13.3	—	H1038
13.8–15.7	13.7–15.5	—	13.4–14.9	—	H1039
15.8–17.3	15.6–17.2	—	15.0–16.9	—	H1040
17.4–19.9	17.3–19.8	—	17.0–18.5	—	H1041
20.0–22.9	19.9–22.7	20.0–22.9	18.6–20.7	—	H1042
23.0–26.4	22.8–26.0	23.0–26.4	20.8–23.0	—	H1043
26.5–30.6	26.1–30.0	26.5–30.6	23.1–25.7	—	H1044
30.7–35.5	30.1–34.4	30.7–35.5	25.8–27.0	—	H1045
35.6–41.2	34.5–39.5	35.6–41.2	—	—	H1046
41.3–46.5	39.6–44.3	41.3–46.5	—	—	H1047
46.6–52.4	44.4–49.9	46.6–52.4	—	—	H1048
52.5–57.8	50.0–54.3	52.5–57.8	—	—	H1049
57.9–63.6	54.4–59.8	57.9–63.6	—	—	H1050
63.7–69.9	59.9–65.1	63.7–69.9	—	—	H1051
70.0–79.5	65.2–73.1	70.0–79.5	—	—	H1052
79.6–90.0	73.2–83.9	79.6–92.0	—	—	H1054

**Note**

Individually boxed heaters master packed 10 per carton.

#### Type 8LT Slow Trip Eutectic Alloy

For replacement in existing applications only; for motors with 1.15 service factor.

Table LT-1 NEMA Size 00, 0, 1, 1-1/2 For Enclosed Type Catalog Prefix A13	Table LT-2 For Open Type Catalog Prefix A13, C303 For Enclosed Type Catalog Prefix C303	Table LT-3 NEMA Size 2 For Enclosed Type Catalog Prefix A13	Table LT-4 NEMA Size 2 For Open Type Catalog Prefix A13, C303 For Enclosed Type Catalog Prefix C303	Table LT-5 NEMA Size 3 For Enclosed Type Catalog Prefix A13	Table LT-6 NEMA Size 3 For Open Type Catalog Prefix A13, C303	Table LT-7 NEMA Size 4 For Open Type Catalog Prefix A13, C303 For Enclosed Type Catalog Prefix A13	Table LT-8 NEMA Size 5 For Open and Enclosed Type Catalog Prefix A13	Heater Catalog Number
Heater Ampere Range								
0.167–0.186	0.167–0.186	—	—	—	—	—	—	H1001
0.187–0.209	0.187–0.209	—	—	—	—	—	—	H1002
0.210–0.233	0.210–0.233	—	—	—	—	—	—	H1003
0.234–0.260	0.234–0.260	—	—	—	—	—	—	H1004
0.261–0.293	0.261–0.293	—	—	—	—	—	—	H1005
0.294–0.329	0.294–0.329	—	—	—	—	—	—	H1006
0.330–0.373	0.330–0.373	—	—	—	—	—	—	H1007
0.374–0.417	0.374–0.417	—	—	—	—	—	—	H1008
0.418–0.471	0.418–0.471	—	—	—	—	—	—	H1009
0.472–0.531	0.472–0.531	—	—	—	—	—	—	H1010
0.532–0.591	0.532–0.591	—	—	—	—	—	—	H1011
0.592–0.660	0.592–0.660	—	—	—	—	—	—	H1012
0.661–0.739	0.661–0.739	—	—	—	—	—	—	H1013
0.740–0.823	0.740–0.823	—	—	—	—	—	—	H1014
0.824–0.919	0.824–0.919	—	—	—	—	—	—	H1015
0.920–1.01	0.920–1.01	—	—	—	—	—	—	H1016
1.02–1.14	1.02–1.14	—	—	—	—	—	—	H1017
1.15–1.27	1.15–1.27	—	—	—	—	—	—	H1018
1.28–1.41	1.28–1.41	—	—	—	—	—	—	H1019
1.42–1.61	1.42–1.61	—	—	—	—	—	—	H1020
1.62–1.86	1.62–1.86	—	—	—	—	—	96.8–111	H1021
1.87–2.01	1.87–2.01	—	—	—	—	—	112–120	H1022
2.02–2.27	2.02–2.27	—	—	—	—	—	121–136	H1023
2.28–2.51	2.28–2.51	—	—	—	—	—	137–150	H1024
2.52–2.80	2.52–2.80	—	—	—	—	—	151–168	H1025
2.81–3.21	2.81–3.21	—	—	—	—	—	169–192	H1026
3.22–3.51	3.22–3.51	—	—	—	—	—	193–210	H1066
3.52–3.86	3.52–3.86	3.67–3.99	3.67–3.99	—	—	—	211–231	H1027
3.87–4.36	3.87–4.36	4.00–4.51	4.00–4.51	—	—	—	232–261	H1028
4.37–4.78	4.37–4.83	4.52–5.03	4.52–5.03	—	—	—	262–293	H1029

#### Notes

Individually boxed heaters master packed 10 per carton.

Individually boxed heater coils master packed 10 per carton.

**Type LT Slow Trip Eutectic Alloy, continued**

For replacement in existing applications only; for motors with 1.15 service factor.

Table LT-1 NEMA Size 00, 0, 1, 1-1/2  For Enclosed Type Catalog Prefix A13	Table LT-2  For Open Type Catalog Prefix A13, C303 For Enclosed Type Catalog Prefix C303	Table LT-3 NEMA Size 2  For Enclosed Type Catalog Prefix A13	Table LT-4 NEMA Size 2  For Open Type Catalog Prefix A13, C303 For Enclosed Type Catalog Prefix C303	Table LT-5 NEMA Size 3  For Enclosed Type Catalog Prefix A13	Table LT-6 NEMA Size 3  For Open Type Catalog Prefix A13, C303	Table LT-7 NEMA Size 4  For Open Type Catalog Prefix A13, C303 For Enclosed Type Catalog Prefix A13	Table LT-8 NEMA Size 5  For Open and Enclosed Type Catalog Prefix A13	Heater Catalog Number
Heater Ampere Range								
4.79–5.35	4.84–5.41	5.04–5.59	5.04–5.59	—	—	—	—	H1030
5.36–6.00	5.42–6.07	5.60–6.20	5.60–6.20	—	—	—	—	H1031
6.01–6.59	6.08–6.66	6.21–6.88	6.21–6.88	—	—	—	—	H1032
6.60–7.35	6.67–7.51	6.89–7.80	6.89–7.80	—	—	—	—	H1033
7.36–8.14	7.52–8.31	7.81–8.71	7.81–8.71	8.16–9.11	8.24–9.19	—	—	H1034
8.15–9.11	8.32–9.27	8.72–9.59	8.72–9.59	9.12–9.99	9.20–10.0	—	—	H1035
9.12–10.0	9.28–10.3	9.60–10.5	9.60–10.7	10.0–11.2	10.1–11.3	—	—	H1036
10.1–11.3	10.4–11.7	10.6–11.8	10.8–12.0	11.3–12.3	11.4–12.5	—	—	H1037
11.4–12.5	11.8–13.0	11.9–13.3	12.1–13.4	12.4–13.9	12.6–14.1	—	—	H1038
12.6–13.9	13.1–14.5	13.4–14.8	13.5–14.9	14.0–15.5	14.2–15.7	—	—	H1039
14.0–15.5	14.6–16.3	14.9–16.6	15.0–16.8	15.6–17.4	15.8–17.6	—	—	H1040
15.6–17.0	16.4–18.1	16.7–18.5	16.9–18.8	17.5–19.6	17.7–19.8	—	—	H1041
17.1–18.9	18.2–20.3	18.6–20.7	18.9–21.1	19.7–21.9	19.9–22.1	20.0–22.3	—	H1042
19.0–21.2	20.4–23.0	20.8–23.3	21.2–24.1	22.0–24.7	22.2–25.2	22.4–25.5	—	H1043
21.3–23.3	23.1–25.9	23.4–26.5	24.2–27.3	24.8–28.1	25.3–28.7	25.6–28.9	—	H1044
23.4–26.1	26.0–27.0	26.6–30.0	27.4–31.3	28.2–31.8	28.8–32.7	29.0–33.7	—	H1045
26.2–27.0	—	30.1–33.7	31.4–35.5	31.9–36.1	32.8–37.3	33.8–37.5	—	H1046
—	—	33.8–37.5	35.6–40.3	36.2–40.7	37.4–42.3	37.6–42.6	—	H1047
—	—	37.6–41.9	40.4–45.0	40.8–45.5	42.4–47.9	42.7–48.2	—	H1048
—	—	42.0–45.0	—	45.6–52.0	48.0–55.4	48.3–55.9	—	H1049
—	—	—	—	52.1–58.2	55.5–61.9	56.0–62.3	—	H1050
—	—	—	—	58.3–63.2	62.0–67.9	62.4–68.4	—	H1051
—	—	—	—	63.3–68.3	68.0–73.3	68.5–73.7	—	H1052
—	—	—	—	68.4–79.9	73.4–87.9	73.8–88.7	—	H1054

**Notes**

Individually boxed heaters master packed 10 per carton.  
Individually boxed heater coils master packed 10 per carton.

#### Type N

Originally a Westinghouse Product

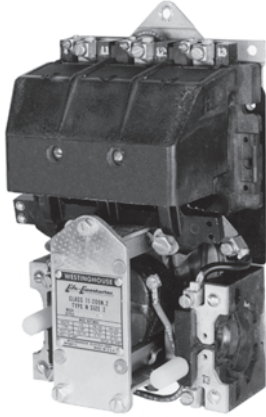

Type N Contactor

#### Product History Time Line for Type N

Size	1940	1950	1960	1970	1980	1990	2000	Present
0-4	[Timeline bar showing continuous production from 1940 to Present]							

#### Replacement Capabilities

##### Contact Kits

NEMA Size	Poles	Style Number
0	3	1605226
1	3	1605212
2	3	1605202
3	3	1625563
4	3	1625564

##### AC Coils

Voltage	Hz	Part Number		Part Number	
		Two-, Three-Pole Original	New	Four-, Five-Pole Original	New
<b>Sizes 0, 1</b>					
220/380/440	25/50/60	1470243	9969D90G03	1470263	9969D90G18
550	60	1470244	9969D90G04	N/A	N/A
120	60	1605268	9969D90G09	N/A	N/A
115/208/230	60/60/60	1605513	9969D90G15	N/A	N/A
600	60	1470245	9969D90G20	N/A	N/A
<b>Size 2</b>					
110/208/220	25/60/60	1470202	9969D92G02	1470222	9969D93G02
220/380/440/480	25/50/60/60	1470203	9969D92G03	N/A	N/A
600	60	1470205	9969D92G08	1470225	9969D93G08
120/110	60/50	1605478	9969D92G10	N/A	N/A
<b>Size 3</b>					
110/208/220	25/60/60	1490646	9969D96G05	1490646	9969D96G05
220/380/400/440	25/50/50/60	1490647	9969D96G06	1490647	9969D96G06
120/110	60/50	1600770	9969D96G09	1600770	9969D96G09
600/500	60/50	1490649	9969D96G21	1490649	9969D96G21
<b>Size 4</b>					
110/208/220	25/60/60	1490658	9969D96G11	1597724	9969D96G02
600/500	60/50	1596635	9969D96G16	1490649	9969D96G21
440	60	1490659	9969D96G12	N/A	N/A
120/110	60/50	1600771	9969D96G20	N/A	N/A

#### Technology Upgrades

Sizes 00-3—Freedom or *IT*.

Sizes 4-5—Freedom, Vacuum or *IT*.

**A200**

Originally a Westinghouse Product

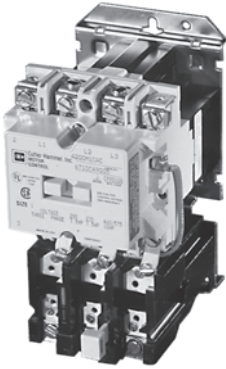

A200 Size 1 Starter



Contact Kit for A200 Model J, Size Two-, Three-Pole

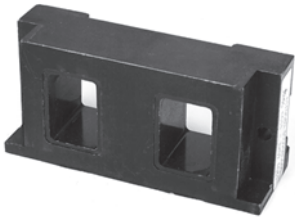

A200 AC Coil, 120/110V, 60/50 Hz, Two-, Three-, Four-Pole, Sizes 00, 0 and 1

Product History Time Line for A200, A201, A203, A204, A206, A210, A211, A213, A214, A216, A220, A223, A224, A226, A250, A251, A600, A603, A604, A606, A700, A703, A704, A706, A800, A804 and A806

Size	Model	1960	1965	1970	1975	1980	1985	1990	1995	2000	Present
00-3	J										
4	J										
4	K										
5-6	Electrically held										
5-6	Mechanically held										
7-8											
9											

**Replacement Capabilities**

**Kits for Model J, Sizes 00, 0, 1 and 2** ①

Description	Poles	Size 00	Size 0	Size 1	Size 2
Contact kit	2	373B331G17	373B331G02	373B331G07	373B331G11
	3	373B331G18	373B331G04	373B331G09	373B331G12
	4	373B331G18	373B331G04	373B331G09	373B331G13 ②
	5	373B331G19	373B331G05	373B331G10	373B331G14 ③
	Arc box ④	2-4	6714C74G01	6714C74G02	6714C74G03
Cross bar	5	6714C74G04	6714C74G05	6714C74G06	6714C74G08 (four-, five-pole)
	2-3	N/A	N/A	N/A	672B788G32
Upper base (for single rated coils only)	4-5	N/A	N/A	N/A	672B788G34
	2-3	N/A	N/A	N/A	672B788G33
Lower base	4-5	N/A	N/A	N/A	672B788G35
	2-3	N/A	N/A	N/A	1250C33G09
KD spring (pk. of 10)	All	N/A	N/A	N/A	1250C33G05
Terminal line/load (pk. of 3)	All	N/A	N/A	N/A	503C796G01
					371B870G03

**AC Coils**

Voltage	Hz	Sizes 00, 0 and 1		Size 2	
		Two-, Three-, Four-Pole	Five-Pole	Two-, Three-Pole	Four-, Five-Pole
120/110	60/50	505C806G01	505C808G01	505C806G01	505C818G01
208	60	505C806G02	505C808G02	505C806G02	505C818G02
600/550	60/50	505C806G05	505C808G05	505C806G05	505C818G05
380	50	505C806G07	505C808G07	505C806G07	505C818G07
240/220	60/50	505C806G12	505C808G12	505C806G12	505C818G12
480/440	60/50	505C806G13	505C808G13	505C806G13	505C818G13
24	60	505C806G16	N/A	505C806G16	505C818G15
277	60	505C806G18	505C808G16	505C806G18	505C818G16
240/480 ⑤	60/60	505C806G03	505C808G03	505C806G03	505C818G03
120/240 ⑤	60/60	505C806G10	505C808G10	505C806G10	505C818G10

**Notes**

- ① Model C contact kits and coils 00-4, two-, three-, four- and five-pole contactors are same as Model J. All other parts are unavailable.
- ② Use quantity two—373B331G11 (two-pole kit).
- ③ Use one each of 373B331G11 (two-pole kit) and 373B331G12 (three-pole kit).
- ④ Mounting hardware included.
- ⑤ Dual voltage coils. Use only on contactors or starters originally supplied with a dual voltage coil.

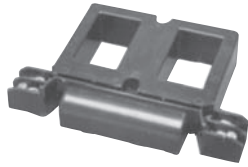

A200 AC Coil, 110/120V, 60 Hz, Size 6



A200 AC Coil, 120/110V, 60/50 Hz, Two-, Three-Pole, Sizes 3 and 4, Model J

#### DC Coils ①

Voltage	Size 0	Size 1	Size 2
	Single-, Two-, Three-, Four-Pole	Single-, Two-, Three-, Four-Pole	Single-, Two-, Three-, Four-Pole
12	1268C86G07	1268C86G07	1268C86G07
24	1268C86G04	1268C86G04	1268C86G04
48	1268C86G05	1268C86G05	1268C86G05
125	1268C86G02	1268C86G02	1268C86G02
250	1268C86G01	1268C86G01	1268C86G01
125/250 ②	1268C86G03	1268C86G03	1268C86G03

#### Kits for Model J-K, Sizes 3 and 4 ③

Description	Poles	Size 3—Model J	Size 4—Model J	Size 4—Model K ④
Contact kit	2	626B187G12	626B187G16	5250C81G16
	3	626B187G13	626B187G17	5250C81G17
	4	626B187G14 ⑤	626B187G18 ⑦	5250C81G18
	5	626B187G15 ⑤	626B187G19 ⑤	5250C81G19
	Arc box	2-3	6714C74G09	6714C74G11
	4-5	6714C74G10	6714C74G12	6714C74G12
	Cross bar	2-3	672B788G36	672B788G36
	4-5	672B788G38	672B788G38	—
	Upper base	2-3	672B788G37	672B788G37
	4-5	672B788G39	672B788G39	—
	Lower base	2-3	1250C33G03	1250C33G03
	4-5	1250C33G06	1250C33G06	—
	KO spring (pk. of 10)	All	503C796G02	503C796G02
Terminals line/load (pk. of 3)	All	372B357G12	372B357G13	372B357G13

#### AC Coils

Voltage	Hz	Model J, Sizes 3-4		Model K, Size 4 ⑥	
		Two-, Three-Pole	Four-, Five-Pole	Two-, Three-Pole	Four-, Five-Pole
120/110	60/50	505C633G01	505C635G01	5250C79G01	5250C80G01
208	60	505C633G02	505C635G02	5250C79G02	5250C80G02
600/550	60/50	505C633G05	505C635G05	5250C79G05	5250C80G05
380	50	505C633G07	505C635G07	5250C79G07	5250C80G07
240/220	60/50	505C633G12	505C635G12	5250C79G12	5250C80G12
480/440	60/50	505C633G13	505C635G13	5250C79G13	5250C80G13
24	60	505C633G34	N/A	5250C79G34	N/A
277	60	505C633G14	N/A	5250C79G14	N/A
240/480 ⑧	60/60	505C633G03	505C635G03	5250C79G03	5250C80G03
120/240 ⑧	60/60	505C633G10	505C635G10	5250C79G10	5250C80G10

#### DC Coils ⑩

Voltage	Model J, Sizes 3-4
	Two-, Three-Pole
24	1255C68G04
48	1255C68G05
125	1255C68G01
250	1255C68G02
125/250	1255C68G03

#### Notes

- ① Use only on contactors originally supplied with a DC coil.
- ② Dual voltage coils. Use only on contactors or starters originally supplied with a dual voltage coil.
- ③ Model C contact kits and coils 00-4, two-, three-, four- and five-pole contactors are same as Model J. All other parts are unavailable.
- ④ Model K replaces Model J.
- ⑤ Use quantity two—626B187G12 (two-pole kits).
- ⑥ Use one of each of 626B187G12 (two-pole kit) and 626B187G13 (three-pole kit).
- ⑦ Use quantity two—626B187G16 (two-pole kit).
- ⑧ Use one each of 626B187G16 (two-pole kit) and 626B187G17 (three-pole kit).
- ⑨ Model K replaces Model J.
- ⑩ Dual voltage coils. Use only on contactors or starters originally supplied with a dual voltage coil.
- ⑪ Use only on units originally supplied with DC coil.



**Kits for GCA 530/630, Sizes 5–9—and GPD Sizes 7–9** ①

Kit	Size 5	Size 6	Size 7	Size 8	Size 9
Contact kit (one per pole)	<b>477B477G05</b> ②	<b>2066A10G11</b>	<b>461A757G17</b>	<b>646C829G05</b>	<b>5264C42G01 (rear connected)</b> <b>5264C42G02 (front connected)</b>
Arc box	<b>2050A15G45</b>	<b>2066A10G45</b>	<b>831D580G01</b>	<b>831D580G01</b>	<b>9917D69G02</b>
Magnet assembly	<b>2050A15G46</b>	<b>2050A15G46</b>	N/A	N/A	N/A
Magnet spacing kit	<b>2050A15G47</b>	<b>2050A15G47</b>	N/A	N/A	N/A
Arc cup kit	<b>2050A15G48</b>	N/A	N/A	N/A	N/A
Load connection kit	<b>2050A15G49</b>	<b>2066A10G49</b>	N/A	N/A	N/A
Line connection kit	<b>2050A15G50</b>	<b>2066A10G50</b>	N/A	N/A	N/A
KO spring-6	<b>2050A15G51</b>	<b>2066A10G46</b>	N/A	N/A	N/A
CT 300/5	<b>655C285H03</b>	N/A	N/A	N/A	N/A
CT 400/5	<b>655C285H04</b>	—	—	—	—
CT 600/5	N/A	<b>2066A10G18</b> ③	N/A	N/A	N/A
CT 800/5	N/A	<b>2066A10G19</b> ③	N/A	N/A	N/A
Phase barrier	N/A	N/A	<b>640C441G01</b>	<b>640C441G01</b>	<b>5264C35G03 (rear connected)</b>
Cross bar	<b>2050A15G12</b>	<b>2066A10G15</b>	N/A	N/A	N/A
Shunt	N/A	<b>2066A10G48</b>	<b>650C129G01</b>	<b>646C831G02 (set of three)</b>	<b>5264C39G02 (set of four)</b>

**Coils**

Voltage	Hz	Size 5	Size 6
110/120	60	<b>2050A14G05</b>	<b>2050A12G05</b>
110/120	50	<b>2050A14G06</b>	<b>2050A12G06</b>
200/208	50	<b>2050A14G07</b>	<b>2050A12G07</b>
220/240	50	<b>2050A14G08</b>	<b>2050A12G08</b>
200/208	60	<b>2050A14G09</b>	<b>2050A12G09</b>
220/240	60	<b>2050A14G10</b>	<b>2050A12G10</b>
277/303	60	<b>2050A14G12</b>	<b>2050A12G12</b>
380/415	50	<b>2050A14G14</b>	<b>2050A12G14</b>
440/480	60	<b>2050A14G15</b>	<b>2050A12G15</b>
440/480	50	<b>2050A14G16</b>	<b>2050A12G16</b>
550/600	60	<b>2050A14G17</b>	<b>2050A12G17</b>
550/600	50	<b>2050A14G18</b>	<b>2050A12G18</b>
380/415	60	<b>2050A14G19</b>	<b>2050A12G19</b>
120/240	60	<b>2050A14G20</b>	<b>2050A12G20</b>
24 DC	—	<b>2050A14G21</b>	<b>2050A12G21</b>
48 DC	—	<b>2050A14G22</b>	<b>2050A12G22</b>
125 DC	—	<b>2050A14G25</b>	<b>2050A12G25</b>
250 DC	—	<b>2050A14G27</b>	<b>2050A12G27</b>

**Coils**

Line Voltage	Sizes 7–8	Required	Size 9
115 Vdc	<b>438C805G01</b>	2	100 Vdc
125 Vdc	<b>438C805G04</b>	2	<b>5264C34G01</b> (contains coil and resistor)
230 Vdc	<b>438C805G02</b>	2	
250 Vdc	<b>438C805G03</b>	2	
110/120 Vac ④⑤	<b>438C805G12</b>	2	
220/240 Vac ⑥⑦	<b>438C805G11</b>	2	
380 Vac ⑥⑦	<b>438C805G15</b>	2	
440/480 Vac ⑥⑦	<b>438C805G10</b>	2	
550/575 Vac ⑥⑦	<b>438C805G13</b>	2	

**Notes**

- ① Catalog No. A201/A200 Series replaces GCA/GPD Series. Renewal parts are the same.
- ② Use **477B477G06** for Silver Tungsten applications.
- ③ CT Kit replaces the single molded one CT assembly used on the old Size 6 airbrake. The kit includes a single molded three CT assembly, two busbars and hardware. This CT Kit also replaces the single molded three CT assembly used on the present Size 6 airbrake and Size 6 vacuum contactor.
- ④ Rectifier 125V **2018A40G01** (one required).
- ⑤ Rectifier 250V **2018A40G02** (one required).
- ⑥ Rectifier 600V **2018A40G03** (one required).
- ⑦ These coils require an external rectifier. If the rectifier needs to be replaced, order by the appropriate style number.



**DC Coil Conversion Kit—  
Style Number 7864A29G01**

A rectifier circuit converts the AC supply to DC supply. This conversion provides quiet operation and improves pickup and dropout characteristics. All necessary parts are included in the kit.



**L63—Style Number 578D461G01**

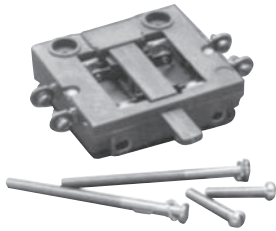

**L64—Style Number 843D943G04**

#### Accessories for Size 5–9 AC Contactors—Coils

AC Contactors	Voltage	AC/DC Coil Conversion Kit	Replacement Coil
Size 5	120 Vac	<b>7864A28G01</b>	<b>7856A15G05</b>
	240 Vac	<b>7864A28G02</b>	<b>7856A15G10</b>
	480 Vac	<b>7864A28G03</b>	<b>7856A15G15</b>
Size 6	120 Vac	<b>7864A29G01</b>	<b>7856A16G05</b>
	240 Vac	<b>7864A29G02</b>	<b>7856A16G10</b>
	480 Vac	<b>7864A29G03</b>	<b>7856A16G15</b>

#### Accessories for Size 5–9 AC Contactors—Auxiliary Electrical Interlock

Contactor Size	Catalog Number (Obsolete)	Style Number (Obsolete)	Circuits	Catalog Number (Current)	Style Number (Current)
00–6	(L-56)	(2609D01G01)	1NO and 1NC	<b>J11</b>	<b>9084A17G01</b>
	(L-56D)	(2609D01G02)	2NO	<b>J20</b>	<b>9084A17G02</b>
	(L-56E)	(2609D01G03)	1NO and 1NC	<b>J11</b>	<b>9084A17G01</b>
	(L-56B)	(2609D01G04)	2NO	<b>J20</b>	<b>9084A17G02</b>
	(L-56H)	(2609D01G05)	2NO	<b>J20</b>	<b>9084A17G02</b>
	(L-56J)	(2609D01G06)	1NO and 1NC DB	<b>J1C</b>	N/A
	(T-56A)	(2609D01G07)	N/A	N/A	N/A
	(T-56A)	(2609D01G07)	N/A	N/A	N/A
	(T-56B)	(2609D01G08)	N/A	N/A	N/A
	(L-56F)	(2609D01G09)	N/A	N/A	N/A
	(L-56G)	(2609D01G10)	1NO and 1NC DB	<b>J1C</b>	<b>9084A17G04</b>
	(L-56C)	(2609D01G11)	2NC	<b>J02</b>	<b>9084A17G03</b>
	(L-56M)	(2609D01G12)	N/A	N/A	N/A
	(L-56P)	(2609D01G17)	1NO and 1NC	<b>J11</b>	<b>9084A17G01</b>
	(L-56R)	(2609D01G18)	2NC	<b>J02</b>	<b>9084A17G03</b>
(L-56S)	(2609D01G19)	1NO and 1NC	<b>J11</b>	<b>9084A17G01</b>	
7–8	L63	—	NO	—	<b>578D461G01</b>
	L63	—	NC	—	<b>578D461G03</b>
9	L64	—	NO/NC	—	<b>843D943G04</b>
	L64	—	2NO	—	<b>843D943G05</b>
	L64	—	2NC	—	<b>843D943G06</b>

#### Technology Upgrades

Sizes 00–3—Freedom or **IT**.  
 Sizes 4–6—Freedom, Vacuum or **IT**.  
 Sizes 7–8—Freedom  
 Size 9—No upgrade available

**Manual Reset, Class 20, Thermal Type B Overload Relay**

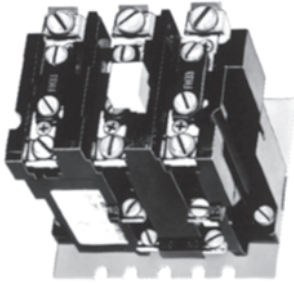

Type B Overload Relay, Panel Mounted



Field-Mountable Alarm Contact

**Note:** Alarm contact available as factory modification of field mountable. For factory modification, add suffix B.

**Application Description**

The Type B overload relay is designed to protect industrial motors against overload conditions. Using modern block-type, bimetallic design, this relay will provide Class 20 operation in either single-phase or three-phase applications.

**Features**

- Ambient compensation standard
- Alarm contact field mountable
- Class 20—600V design
- Inverse time delay trip
- Test trip device for weld check
- High visibility up-front trip indication
- Trip-free reset mechanism

**Operation**

The Type B overload relay is a bimetallic actuated device. The bimetal elements are operated by precisely calibrated heaters. The heater elements connect either directly in the circuit to be measured, or through current transformers on applications NEMA Size 5 and larger.

As the bimetals are heated by motor current flow, a deflection force is produced. Upon a sustained level of abnormal current flow, the deflection becomes great enough to open the snap action output contact.

**Ambient Compensation**

The Type B ambient compensated design is supplied as standard on all A200 starters. This design uses a second compensating bimetal responsive to ambient air temperature in the surrounding enclosure. This feature reduces nuisance tripping in applications using compact control panels and motor control centers where internal temperature rise is significant compared to motor ambient temperature. The compensating characteristic is maintained in ambient temperatures from 40°C to 77°C.

**Design Standards**

UL® 508, CSA®, ANSI/NEMA ICS 2-222.

**Overload Relay Selection Table**

For replacement in existing applications only.

Motor Full Load Amperes	Panel Mounted Catalog Number	Starter Mounted Catalog Number				Replacement for Type A Overload Relays in Manual Reset Mode (Three-Pole Only) ①	
		Non-Comp.	Ambient Comp.	Non-Comp.	Ambient Comp.	Non-Comp.	
<b>Single-Pole (One NC Contact)</b>							
0.25–26.2	BA11JP	BN11JP	BA11A	BN11A	—	—	
26.3–45.0	BA21JP	BN21JP	BA21A	BN21A	—	—	
19.0–90.0	Use three-pole design, wire three-poles in series						
19.0–135.0							
<b>Three-Pole (One NC Contact)</b>							
0.25–26.2	BA13JP	BN13JP	BA13A ②	BN13A ②	BA13J	BN13J	
26.3–45.0	BA23JP	BN23JP	BA23A	BN23A	BA23J	BN23J	
19.0–90.0	BA33P	BN33P	BA33A	BN33A	BA33A	BN33A	
19.0–135.0	BA43P	BN43P	BA43A	BN43A	BA43A	BN43A	

**Alarm Contact Kit Selection**

Type B Overload Relay Size	Catalog Number
1, 2	B3NO-2
3, 4	B3NO-4

**Heaters**

Price of overload relay does not include heaters. Select from the tables on **Pages V12-T13-30 to V12-T13-32.**

**Notes**

- ① Includes contactor mounting bracket, overload relay and connection straps to contactor.
- ② For replacement on B200 sizes 00, 0 and 1, use **BA23A** instead of **BA13A** and use **BN23A** instead of **BN13A**.

#### Auto/Manual Reset, Class 20, Thermal Type A Overload Relay

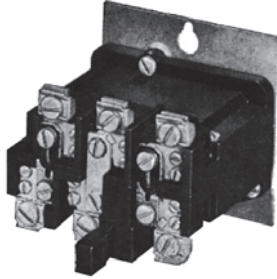

Three-Pole Panel Mounted

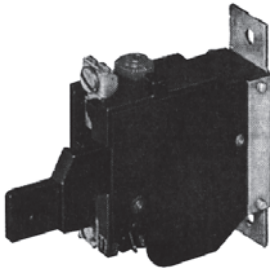

Single-Pole Panel Mounted

#### Application Description

The Type A overload relay is designed to protect industrial motors against overload conditions. Using modern block-type, bimetallic design, this relay will provide Class 20 operation in either single-phase or three-phase applications.

#### Features

- Field selectable manual/auto reset
- Alarm contact factory available
- Class 20—600V design
- Inverse time delay trip
- Adjustable trip rating  $\pm 15\%$
- Color-coded reset rod: Compensated (gray) Non-compensated (red)

#### Operation

The Type A overload relay is a bimetallic actuated device. The bimetal elements are operated by precisely calibrated heaters. The heater elements connected either directly in the circuit to be measured, or through current transformers on applications NEMA Size 5 and larger.

As the bimetals are heated by motor current flow, a deflection force is produced. Upon a sustained level of abnormal current flow, the deflection becomes great enough to open the snap action output contact.

#### Automatic Reset

The Type A overload relay can be supplied as an option on all A200 starters to provide automatic reset operation. The overload relay is always shipped in the non-automatic mode. To set up auto operation, reposition the reset rod by loosening and re-tightening a hold-down clamp at the base of overload relay.

#### Design Standards

UL 508, CSA, ANSI/NEMA ICS 2-222.

#### Overload Relay Selection Table

For replacement in existing applications only.

Motor Full Load Amperes	Panel Mounted Catalog Number		Starter Mounted Catalog Number	
	Ambient Comp.	Non-Comp.	Ambient Comp.	Non-Comp.
<b>Single-Pole (One NC Contact)</b>				
0.25–26.2	AA11P	AN11P	AA11A	AN11A
26.3–45.0	AA21P	AN21P	AA21A	AN21A
19.0–90.0	AA31P	AN31P	AA31A	AN31A
19.0–135.0	AA41P	AN41P	AA41A	AN41A
<b>Three-Pole (One NC Contact) <sup>①</sup></b>				
0.25–26.2	AA13P	AN13P	AA13A	AN13A
26.3–45.0	AA23P	AN23P	AA23A	AN23A
19.0–90.0	AA33P	AN33P	AA33A	AN33A
19.0–135.0	AA43P	AN43P	AA43A	AN43A

#### Heaters

Price of overload relay does not include heaters. Select from the tables on **Pages V12-T13-30 to V12-T13-32.**

#### Notes

- <sup>①</sup> Three-pole Type B Overload Relay is a suitable alternative to a three-pole Type A Overload Relay in Manual Reset Mode. For example, use **BA13JP** for **AA13P** and **BN23J** for **AN23A**, etc. (See **Page V12-T13-27.**)

Alarm contact available only as factory modification on Type A relay.

**Type FT Fast Trip, Class 10 Overload Relay**

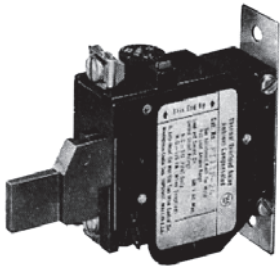

*Single-Pole Fast Trip, Panel Mounted*

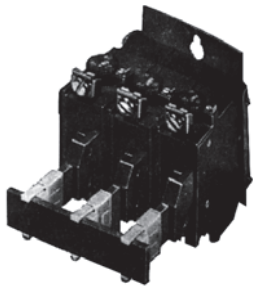

*Three-Pole Fast Trip, Panel Mounted*

**Application Description**

The Type FT overload relay is designed to protect special purpose motors having restricted thermal and locked rotor capabilities. Using modern block-type, bimetallic design, this relay will provide Class 10 operation in single-phase or three-phase applications.

**Features**

- Class 10—600V design
- Inverse time delay trip
- Color-coded reset rod—green
- Alarm contact factory available
- Field selectable manual/auto reset
- Adjustable trip rating ±20%
- Ambient compensation included

**Operation**

The Type FT overload relay is a bimetallic actuated device. The bimetal elements are operated directly from line current, thus separate calibrating heater elements are not used. The overload relay may be wired directly in the motor circuit, or through current transformers on applications larger than 150A.

As the bimetals are heated by motor current flow, a deflection is produced. Upon a sustained level of abnormal current flow, the deflection becomes great enough to open the snap action output contact.

**Overload Relay Selection Table**

For replacement in existing applications only.

Motor Full Load Amperes	Panel Mounted Catalog Number		Starter Mounted Catalog Number <sup>①</sup>	
	Single-Pole <sup>①</sup>	Three-Pole <sup>②</sup>	NEMA Size	Single-Pole
<b>Single-Pole (One NC Contact); Three-Phase (Three NC Contacts in Series)</b>				
0.76–1.1	FT11P-1.1	FT13P-1.1	—	FT11A-1.1
1.1–1.6	FT11P-1.6	FT13P-1.6	—	FT11A-1.6
1.6–2.4	FT11P-2.4	FT13P-2.4	0, 1	FT11A-2.4
2.4–3.6	FT11P-3.6	FT13P-3.6	0, 1	FT11A-3.6
3.6–5.4	FT11P-5.4	FT13P-5.4	0, 1	FT11A-5.4
5.4–8.0	FT11P-8	FT13P-8	0, 1	FT11A-8
8.0–12	FT11P-12	FT13P-12	0, 1	FT11A-12
12–18	FT11P-18	FT13P-18	1	FT11A-18
16–24	FT11P-24	FT13P-24	1	FT11A-24
22–32	FT11P-32	FT13P-32	0, 1	FT11A-32
24–36	FT21P-36	FT23P-36	2	FT21A-36
36–54	FT21P-54	FT23P-54	2	FT21A-54
22–32	FT31P-32	FT33P-32	3	FT31A-32
32–48	FT31P-48	FT33P-48	3	FT31A-48
48–72	FT31P-72	FT33P-72	3	FT31A-72
72–110	FT41P-110	FT43P-110	4	FT41A-110
100–150	FT41P-150	FT43P-150	4	FT41A-150

**Notes**

- ① Single-pole (one NO–NC contact): Add suffix B.
  - ② Three-pole (three NO–NC contacts): Add suffix B. Example: **FT13PB-12**.
- Alarm contact available only as factory modification on FT relay.

#### Heaters for Thermal Types A and B Overload Relays

##### Product Description

Each heater is identified by a catalog number stamped on one terminal. The heater application table indicates the range of full load motor current to which a given heater may be applied.

Heaters should be selected on the basis of the actual full load current and service factor as shown on the motor nameplate or in the manufacturer's published literature.

When motor and overload relay are in the same ambient and the service factor of the motor is 1.15 to 1.25, select heaters from the heater application table. If the service factor of the motor is 1.0, or there is no service factor shown, or a maximum of 115% protection is desired, select one size smaller heater than indicated.

When motor and overload relay are in different ambients and when using non-compensated overload relays, select heaters from the tables on **Pages V12-T13-30** through **V12-T13-32** using adjusted motor currents as follows: decrease rated motor current 1% for each °C motor ambient exceeds controller ambient. Increase rated motor current 1% for each °C controller ambient exceeds motor ambient.

For temperature compensated overload relays, select heaters according to the tables on **Pages V12-T13-30** through **V12-T13-32** and selection information above regardless of ambient.

Protect the starter against short circuits by providing branch circuit protection per National Electrical Code® (NEC®).

#### Heater Selection for Types A and B Overload Relays, Sizes 00, 0, 1 and 2 Starters

Non-Compensated Open Starters and Ambient Compensated Open and Enclosed Starters		Non-Compensated Enclosed Starters		Heater Catalog Number
Block-Type Overload Using Three Heaters	Single-Pole Type Overload	Block-Type Overload Using Three Heaters	Single-Pole Type Overload	
<b>Full Load Current of Motor (Amperes) ①②</b>				
<b>For Sizes 0, 1 and 2 Starters</b>				
0.25–0.27	0.29–0.31	0.24–0.25	0.28–0.30	FH03
0.28–0.31	0.32–0.35	0.26–0.28	0.31–0.34	FH04
0.32–0.34	0.36–0.39	0.29–0.31	0.35–0.37	FH05
0.35–0.38	0.40–0.43	0.32–0.35	0.38–0.42	FH06
0.39–0.42	0.44–0.48	0.36–0.39	0.43–0.47	FH07
0.43–0.46	0.49–0.53	0.40–0.43	0.48–0.52	FH08
0.47–0.50	0.54–0.58	0.44–0.47	0.53–0.56	FH09
0.51–0.55	0.59–0.64	0.48–0.51	0.57–0.63	FH10
0.56–0.62	0.65–0.71	0.52–0.57	0.64–0.70	FH11
0.63–0.68	0.72–0.79	0.58–0.63	0.71–0.77	FH12
0.69–0.75	0.80–0.87	0.64–0.70	0.78–0.85	FH13
0.76–0.83	0.88–0.96	0.71–0.77	0.86–0.94	FH14
0.84–0.91	0.97–1.06	0.78–0.85	0.95–1.03	FH15
0.92–1.00	1.07–1.16	0.86–0.93	1.04–1.13	FH16
1.01–1.11	1.17–1.28	0.94–1.03	1.14–1.25	FH17
1.12–1.22	1.29–1.41	1.04–1.13	1.26–1.38	FH18
1.23–1.34	1.42–1.55	1.14–1.25	1.39–1.52	FH19
1.35–1.47	1.56–1.71	1.26–1.37	1.53–1.67	FH20
1.48–1.62	1.72–1.87	1.38–1.51	1.68–1.83	FH21
1.63–1.78	1.88–2.06	1.52–1.65	1.84–2.01	FH22
1.79–1.95	2.07–2.26	1.66–1.81	2.02–2.21	FH23
1.96–2.15	2.27–2.48	1.82–1.99	2.22–2.43	FH24
2.16–2.35	2.49–2.72	2.00–2.19	2.44–2.66	FH25
2.36–2.58	2.73–2.99	2.20–2.39	2.67–2.92	FH26
2.59–2.83	3.00–3.28	2.40–2.63	2.93–3.21	FH27
2.84–3.11	3.29–3.60	2.64–2.89	3.22–3.53	FH28
3.12–3.42	3.61–3.95	2.90–3.17	3.54–3.87	FH29
3.43–3.73	3.96–4.31	3.18–3.47	3.88–4.22	FH30
3.74–4.07	4.32–4.71	3.48–3.79	4.23–4.61	FH31
4.08–4.39	4.72–5.14	3.80–4.11	4.62–4.9	FH32
4.40–4.87	5.15–5.6	4.12–4.55	5.0–5.5	FH33
4.88–5.3	5.7–6.2	4.56–5.0	5.6–6.0	FH34

##### Notes

① Based on 60°C and 75°C wire for 30A or less.

② Based on 60°C wire for 31 to 95A.

Heaters are packaged in strips of six. Minimum ordering quantity is 12.

Heater Selection for Types A and B Overload Relays, Sizes 00, 0, 1 and 2 Starters, continued

Non-Compensated Open Starters and Ambient Compensated Open and Enclosed Starters		Non-Compensated Enclosed Starters		Heater Catalog Number
Block-Type Overload Using Three Heaters	Single-Pole Type Overload	Block-Type Overload Using Three Heaters	Single-Pole Type Overload	
Full Load Current of Motor (Amperes) <sup>①②</sup>				
<b>For Sizes 0, 1 and 2 Starters</b>				
5.4–5.9	6.3–6.8	5.1–5.5	6.1–6.6	FH35
6.0–6.4	6.9–7.5	5.6–5.9	6.7–7.3	FH36
6.5–7.1	7.6–8.2	6.0–6.6	7.4–8.0	FH37
7.2–7.8	8.3–9.0	6.7–7.2	8.1–8.7	FH38
7.9–8.5	9.1–9.9	7.3–7.9	8.8–9.7	FH39
8.6–9.4	10.0–10.8	8.0–8.7	9.8–10.5	FH40
9.5–10.3	10.9–11.9	8.8–9.5	10.6–11.7	FH41
10.4–11.3	12.0–13.1	9.6–10.5	11.8–12.7	FH42
11.4–12.4	13.2–14.3	10.6–11.5	12.8–14.0	FH43
12.5–13.5	14.4–15.7	11.6–12.6	14.1–15.3	FH44
13.6–14.9	15.8–17.2	12.7–13.8	15.4–16.6	FH45
15.0–16.3	—	13.9–15.1	—	FH46
16.4–18.0	—	15.2–16.7	—	FH47
<b>For Sizes 1 and 2 Starters</b>				
—	17.3–18.9	—	16.7–18.3	FH46
—	19.0–20.8	—	18.4–20.0	FH47
18.1–19.8	20.9–22.9	16.8–18.3	20.1–21.9	FH48
19.9–21.7	23.0–25.2	18.4–20.2	22.0–23.9	FH49
21.8–23.9	25.3–27.6	20.3–22.2	24.0–26.2	FH50
24.0–26.2	—	22.3–24.3	—	FH51
—	—	24.4–26.6	—	FH52
<b>For Size 2 Starters</b>				
—	27.7–30.3	—	26.3–28.8	FH51
26.3–28.7	30.4–33.3	—	28.9–31.4	FH52
28.8–31.4	33.4–36.4	26.7–29.1	31.5–34.5	FH53
31.5–34.0	36.5–39.9	29.2–32.0	34.6–37.9	FH54
34.6–37.9	42.0–43.9	32.1–35.2	38.0–41.9	FH55
38.0–41.5	—	35.3–38.5	42.0–45.0	FH56
41.6–45.0	—	38.6–42.3	—	FH57

Notes

① Based on 60°C and 75°C wire for 30A or less.

② Based on 60°C wire for 31 to 95A.

Heaters are packaged in strips of six. Minimum ordering quantity is 12.

#### Heater Selection for Types A and B Overload Relays, Sizes 3 and 4 Starters <sup>①②③</sup>

Ambient Compensated Enclosed Starters	Non-Compensated Enclosed Starters	Heater Catalog Number
<b>All Applications</b>		
<b>Full Load Current of Motor (Amperes) <sup>①</sup></b>		
<b>For Sizes 3 and 4 Starters</b>		
12.8–14.1	11.9–13.0	<b>FH68</b>
14.2–15.5	13.1–14.3	<b>FH69</b>
15.6–17.1	14.4–15.9	<b>FH70</b>
17.2–18.9	16.0–17.4	<b>FH71</b>
19.0–20.8	17.5–19.1	<b>FH72</b>
20.9–22.9	19.2–21.1	<b>FH73</b>
23.0–25.2	21.2–23.2	<b>FH74</b>
25.3–27.8	23.3–25.6	<b>FH75</b>
27.9–30.6	25.7–28.1	<b>FH76</b>
30.7–33.5	28.2–30.8	<b>FH77</b>
33.6–37.5	30.9–34.5	<b>FH78</b>
37.6–41.5	34.6–38.2	<b>FH79</b>
41.6–46.3	38.3–42.6	<b>FH80</b>
46.4–50	42.7–46	<b>FH81</b>
51–55	47–51	<b>FH82</b>
56–61	52–56	<b>FH83</b>
62–66	57–61	<b>FH84</b>
67–73	62–67	<b>FH85</b>
74–78	68–72	<b>FH86</b>
79–84	73–77	<b>FH87</b>
85–92	78–84	<b>FH88</b>
—	85–91	<b>FH89</b>
<b>For Size 4 Starters</b>		
93–101	—	<b>FH89</b>
102–110	92–99	<b>FH90</b>
111–122	100–110	<b>FH91</b>
123–129	111–122	<b>FH92</b>
130–133	123–128	<b>FH93</b>
—	129–133	<b>FH94</b>

#### Heater Selection for Types A and B Overload Relays, Sizes 5 and 6 Starters <sup>④</sup>

Compensated Overload Relay		Heater Catalog Number
Open Starter	Enclosed Starter	
Full Load Current of Motor (Amperes)		
<b>Size 5 (With 300/5 Current Transformers)</b>		
—	—	<b>FH23</b>
118–129	118–129	<b>FH24</b>
130–141	130–141	<b>FH25</b>
142–155	142–155	<b>FH26</b>
156–170	156–170	<b>FH27</b>
171–187	171–187	<b>FH28</b>
188–205	188–205	<b>FH29</b>
206–224	206–224	<b>FH30</b>
225–244	225–244	<b>FH31</b>
245–263	245–263	<b>FH32</b>
264–292	264–292	<b>FH33</b>
293–300	—	<b>FH34</b>
<b>Size 6 (With 600/5 Current Transformers)</b>		
—	—	<b>FH23</b>
236–259	236–259	<b>FH24</b>
260–283	260–283	<b>FH25</b>
284–310	284–310	<b>FH26</b>
311–340	311–340	<b>FH27</b>
341–374	341–374	<b>FH28</b>
375–411	375–411	<b>FH29</b>
412–448	412–448	<b>FH30</b>
449–489	449–489	<b>FH31</b>
490–527	490–527	<b>FH32</b>
528–585	528–540	<b>FH33</b>
586–600	—	<b>FH34</b>
<b>Size 7 and Larger</b>		
Advise full load current		

**Notes**

- ① Based on 60°C and 75°C wire for 30A or less.
- ② Based on 60°C wire for 31 to 95A.
- ③ Based on 75°C wire for greater than 95A.
- ④ Based on 75°C wire.

Heaters are packaged in strips of six. Minimum ordering quantity is 12.



**A202 Lighting Contactor (Electrically Held/Magnetically Latched)**

*Originally a Westinghouse Product*

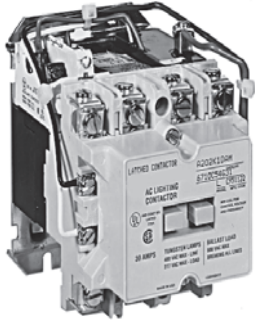

30A, Four-Pole Magnetically Latched

**Product History Time Line for A202 Lighting Contactor (Electrically Held/Magnetically Latched)**

Size	Amperes	Model	1965	1970	1975	1980	1985	1990	1995	2000	Present
Size 1	30										
Size 2	60										
Size 3	100										
Size 4	200	J									
Size 4	200	K									

**Replacement Capabilities**

**A202 Kits for 30 to 200A**

Description	Poles	30A	60A	100A	200A— Model J ①	200A— Model K ②
Contact kit	2	373B331G07	373B331G11	626B187G12	626B187G16	5250C81G16
	3	373B331G09	373B331G12	626B187G13	626B187G17	5250C81G17
	4	373B331G09	③	⑤	⑦	5250C81G18
	5	373B331G10	④	⑥	⑧	5250C81G19
Arc box	2, 3, 4	6714C74G03	6714C74G07	6714C74G09	6714C74G11	6714C74G11
	5	6714C74G06	6714C74G08	6714C74G10	6714C74G12	6714C74G12
Cross bar	2-3	—	672B788G32	672B788G36	672B788G36	672B788G40
	4-5	—	672B788G34	672B788G38	672B788G38	—
Upper base (for single rated coils only)	2-3	—	672B788G33	672B788G37	672B788G37	672B788G52
	4-5	—	672B788G35	672B788G39	672B788G39	—
Lower base	2-3	—	1250C33G09	1250C33G03	1250C33G03	1250C33G10
	4-5	—	1250C33G05	1250C33G06	1250C33G06	—
<b>Electrically Held Only</b>						
KO spring (pack of 10)	All	—	503C796G01	503C796G02	503C796G02	672B788G50
Terminal line/load (pack of 3)	All	—	371B870G03	372B357G12	372B357G13	372B357G13

**Notes**

- ① For 200A A202 Magnetically Latched Lighting Contactors, order three-pole contact kit style **672B788G07**.
- ② Model K replaces Model J, offering superior design and life characteristics. Renewal parts are different.  
**Use parts for proper model only.**
- ③ Use quantity two—**373B331G11** (two-pole kit).
- ④ Use one each of **373B331G11** (two-pole kit) and **373B331G12** (three-pole kit).
- ⑤ Use quantity two—**626B187G12** (two-pole kit).
- ⑥ Use one each of **626B187G12** (two-pole kit) and **626B187G13** (three-pole kit).
- ⑦ Use quantity two—**626B187G16** (two-pole kit).
- ⑧ Use one each of **626B187G16** (two-pole kit) and **626B187G17** (three-pole kit).

120V Coil for  
Electrically Held  
Lighting Contactor—  
Style Number  
505C633G01



### AC Coils Electrically Held

Voltage	Hz	30A		60A	
		Two-, Three-, Four-Pole	Five-Pole	Two-, Three-Pole	Four-, Five-Pole
120/110	60/50	505C806G01	505C808G01	505C806G01	505C818G01
208	60	505C806G02	505C808G02	505C806G02	505C818G02
600/550	60/50	505C806G05	505C808G05	505C806G05	505C818G05
380	50	505C806G07	505C808G07	505C806G07	505C818G07
240/220	60/50	505C806G12	505C808G12	505C806G12	505C818G12
480/440	60/50	505C806G13	505C808G13	505C806G13	505C818G13
24	60	505C806G16	N/A	505C806G16	505C818G15
227	60	505C806G18	505C808G16	505C806G18	505C818G16
240/480 ①	60/60	505C806G03	505C808G03	505C806G03	505C818G03
120/240 ①	60/60	505C806G10	505C808G10	505C806G10	505C818G10

### AC Coils Electrically Held, continued

Voltage	Hz	100 and 200A—Model J		200A—Model K ②	
		Two-, Three-Pole	Four-, Five-Pole	Two-, Three-Pole	Four-, Five-Pole
120/110	60/50	505C633G01	505C635G01	52050C79G01	5250C80G01
208	60	505C633G02	505C635G02	52050C79G02	5250C80G02
600/550	60/50	505C633G05	505C635G05	52050C79G05	5250C80G05
380	50	505C633G07	505C635G07	52050C79G07	5250C80G07
240/220	60/50	505C633G12	505C635G12	52050C79G12	5250C80G12
480/440	60/50	505C633G13	505C635G13	52050C79G13	5250C80G13
24	60	505C633G34	N/A	52050C79G34	N/A
227	60	505C633G14	N/A	52050C79G14	N/A
240/480 ①	60/60	505C633G03	505C635G03	52050C79G03	5250C80G03
120/244 ①	60/60	505C633G10	505C635G10	52050C79G10	5250C80G10

#### Notes

- ① Dual voltage coils. Use only on contactors or starters originally supplied with a dual voltage coil.  
 ② Model K replaces Model J. Renewal parts are different. **Use parts for proper model only.**

**AC Coils Magnetically Latched**

Voltage	Hz	Two-Pole	Three-Pole	Four-Pole	Five-Pole
<b>30A</b>					
110/120	50/60	7874A93G01	7874A93G01	7874A93G01	7874A89G01
208/240	50/60	7874A93G02	7874A93G02	7874A93G02	7874A89G02
277	50/60	7874A93G03	7874A93G03	7874A93G03	7874A89G03
440/480	50/60	7874A93G04	7874A93G04	7874A93G04	7874A89G04
575	50/60	7874A93G05	7874A93G05	7874A93G05	7874A89G05
<b>60A</b>					
110/120	50/60	7874A93G01	7874A93G01	7874A87G01	7874A87G01
208/240	50/60	7874A93G02	7874A93G02	7874A87G02	7874A87G02
277	50/60	7874A93G03	7874A93G03	7874A87G03	7874A87G03
440/480	50/60	7874A93G04	7874A93G04	7874A87G04	7874A87G04
110/120	50/60	7874A93G01	7874A93G01	7874A87G01	7874A87G05
<b>100 and 200A</b>					
110/120	50/60	7874A85G01	7874A85G01	7874A83G01	7874A83G01
208/240	50/60	7874A85G02	7874A85G02	7874A83G02	7874A83G02
277	50/60	7874A85G03	7874A85G03	7874A83G03	7874A83G03
440/480	50/60	7874A85G04	7874A85G04	7874A83G04	7874A83G04
550/575	50/60	7874A85G05	7874A85G05	7874A83G05	7874A83G05

**Terminals (Line and Load)**

Size	Two-Pole		Three-Pole		Four-Pole		Five-Pole	
30A	N/A		N/A		N/A		N/A	
60A	179C755G17		179C755G16		179C755G17 ①		179C755G16 + G17 ②	
100A	179C755G19		179C755G18		179C755G19 ①		179C755G18 + G19 ②	
200A	Model K	Model J	Model K	Model J	Model K	Model J	Model K	Model J
	179C755G28	179C755G31	179C755G27	179C755G30	179C755G28 ①	179C755G3 ①	179C755G27 + G28 ②	179C755G30 + G3 ②

**Other Accessories**

Size	Control Module (Rectifier)
30 to 200A	3915B98G01

**Notes**

- ① Order quantity of two for four-pole design.
- ② Group numbers for the five-pole terminals represent the combination of the two-pole and three-pole number.

#### V201 and V200 Vacuum Contactors and Starters

Originally a Westinghouse Product

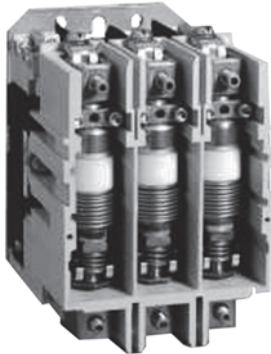

Size 4 Vacuum Contactors

#### Heater Coils

##### Heater Coil Selection for Type B Overload Relay

Motor Full Load Current in Amperes for Use with Three Heaters Only

Open Starter  
Ambient Compensated Overload Relay

Heater Catalog Number <sup>①</sup>

##### Size 4 and 160A

12.8–14.1	FH68
14.2–15.5	FH69
15.6–17.1	FH70
17.2–18.9	FH71
19.0–20.8	FH72
20.9–22.9	FH73
23.0–25.2	FH74
25.3–27.8	FH75
27.9–30.6	FH76
30.7–33.5	FH77
33.6–37.5	FH78
37.6–41.5	FH79
41.6–46.3	FH80
46.4–50	FH81
51–55	FH82
56–61	FH83
62–66	FH84
67–73	FH85
74–78	FH86
79–84	FH87

85–92	FH88
93–101	FH89
102–110	FH90
111–122	FH91
123–129	FH92
130–133	FH93
—	FH94

##### Size 5 and 320A with 300/5 Current Transformers

107–117	FH23
118–129	FH24
130–141	FH25
142–155	FH26
156–170	FH27

171–187	FH28
188–205	FH29
206–224	FH30
225–244	FH31
245–263	FH32

264–292	FH33
293–318	FH34
319–350	FH35

##### Size 6 and 540A with 600/5 Current Transformers

236–259	FH24
260–283	FH25
284–310	FH26
311–340	FH27
341–374	FH28

375–411	FH29
412–448	FH30
449–489	FH31
490–527	FH32
528–585	FH33
586–600	FH34

#### Replacement Coils

##### Vacuum Contactor—Replacement Coils

Description	Suffix	Part Number
<b>Size 4</b>		
110/120 Vac, 50/60 Hz	J	9085A57G01
220/240 Vac, 50/60 Hz	K	9085A57G02
380/415 Vac, 50/60 Hz	H	ID89221G07
440/480 Vac, 50/60 Hz	U	9085A57G03
<b>Size 5</b>		
24 Vdc	—	7874A09G07
48 Vdc	—	7874A09G08
110/120 Vac, 50/60 Hz	J	7874A09G01 <sup>②</sup>
220/240 Vac, 50/60 Hz	K	7874A09G04 <sup>③</sup>
380/415 Vac, 50/60 Hz	H	7874A09G10
440/480 Vac, 50/60 Hz	U	7874A09G05
<b>Size 6</b>		
110/120 Vac, 50/60 Hz	J	7874A24G01 <sup>②</sup>
220/240 Vac, 50/60 Hz	K	7874A24G02 <sup>③</sup>
380/415 Vac, 50/60 Hz	H	7874A24G07
440/480 Vac, 50/60 Hz	U	7874A24G03

##### Notes

- ① Three are required per overload relay.
- ② 125 Vdc can be directly applied to the Size 5 and 6 coil rated for 120V/60 Hz AC (cannot be applied to Size 4).
- ③ 250 Vdc can be directly applied to the Size 5 and 6 coil rated for 240V/60 Hz AC (cannot be applied to Size 4).

**Freedom Series—  
NEMA and IEC**  
*Originally a Cutler-Hammer  
Product*

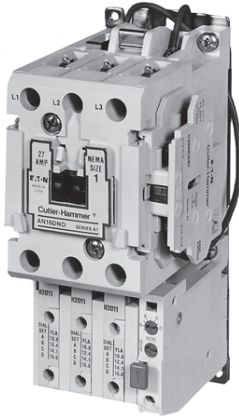

**Freedom**

**Product Description**

The Cutler-Hammer Freedom Series starters and contactors feature a compact space-saving design using state-of-the-art technology and the latest in high strength, impact and temperature-resistant insulating materials. Starters and contactors are available in two rating/configuration styles—NEMA (National Electrical Manufacturers Association) and IEC (International Electrotechnical Commission). The NEMA devices are sized based on traditional NEMA classifications and the IEC devices on international ratings. Internationally rated starters and contactors, as compared to NEMA devices, generally are physically downsized to provide higher ratings in a smaller package.

**Product History Time Line for Freedom CN15 and AN15**

NEMA Size	Series	1986	1988	1990	1992	1994	1996	1998	2000	Present	
Size 00	A1	█									
	B1			█							
Size 0	A1	█									
	B1			█							
Size 1	A1	█									
	B1			█							
Size 2	A1	█									
	B1						█				
Size 3	A1		█								
Size 4	A1		█								
	B1						█				
Size 5	A1		█								
Size 6	A1		█								
	B1						█				
Size 7	A1			█							
Size 8	A1			█							

**Note:** See contactor/starter nameplate to determine Series A1, B1 or C1.

**Replacement Capabilities****NEMA Sizes 00, 0, 1, 2 and 3****NEMA Sizes 00 and 0—See Contactor/Starter Nameplate to Determine Series A1, B1 or C1**

Description Renewal Parts Publication Number	NEMA Size 00–0 Series A1 Part Number None	NEMA Size 00 Series B1 Part Number None	NEMA Size 00 Series C1 Part Number None	NEMA Size 0 Series B1 Part Number None	NEMA Size 0 Series C1 Part Number None
<b>Contact Kits</b>					
Two-pole	①	①	①	①	①
Three-pole	①	①	①	①	①
Four-pole	①	①	①	①	①
Five-pole	①	①	①	①	①
<b>Magnet Coils</b>					
	<b>Coil Suffix</b>				
120V, 60 Hz or 110V, 50 Hz	A	9-2650-1	9-2875-1	9-2875-1	9-2876-1
240V, 60 Hz or 220V, 50 Hz	B	9-2650-2	9-2875-2	9-2875-2	9-2876-2
480V, 60 Hz or 440V, 50 Hz	C	9-2650-3	9-2875-3	9-2875-3	9-2876-3
600V, 60 Hz or 550V, 50 Hz	D	9-2650-4	9-2875-4	9-2875-4	9-2876-4
208V, 60 Hz	E	9-2650-5	9-2875-5	9-2875-5	9-2876-5
277V, 60 Hz	H	9-2650-13	9-2875-12	9-2875-12	9-2876-12
208/240V, 60 Hz	J	—	9-2875-37	9-2875-37	9-2876-17
240V, 50 Hz	K	9-2650-12	9-2875-11	9-2875-11	9-2876-11
380–415V, 50 Hz	L	9-2650-6	9-2875-6	9-2875-6	9-2876-6
380V, 50 Hz	L	—	—	—	—
415V, 50 Hz	M	—	—	—	—
550V, 50 Hz	N	—	—	—	—
24V, 60 Hz–24V, 50 Hz	T	—	9-2875-36	9-2875-36	9-2876-36
24V, 60 Hz	T	9-2650-7	—	—	—
24V, 50 Hz	U	9-2650-14	9-2875-36	9-2875-36	9-2876-36
32V, 50 Hz	V	9-2650-9	9-2875-16	9-2875-16	9-2876-16
48V, 60 Hz	W	9-2650-8	9-2875-8	9-2875-8	9-2876-8
48V, 50 Hz	Y	9-2650-10	9-2875-9	9-2875-9	9-2876-9
<b>Magnet Frame Armature</b>					
Lower magnet frame	①	①	①	①	①
Upper magnet frame	①	①	①	①	①

**Note**

① Replace with complete contactor.

**NEMA Sizes 1, 2 and 3—See Contactor/Starter Nameplate to Determine Series A1 or B1**

Description Renewal Parts Publication Number	NEMA Size 1		NEMA Size 2		NEMA Size 3
	Series A1 Part Number	Series B1 Part Number	Series A1 Part Number	Series B1 Part Number	Part Number
<b>Contact Kits</b>					
Two-pole	6-65	6-65	6-65-7	6-65-7	6-43-5
Three-pole	6-65-2	6-65-2	6-65-8	6-65-8	6-43-6
Four-pole	6-65-9	6-65-9	6-65-15	6-65-15	—
Five-pole	6-65-10	6-65-10	6-65-16	6-65-16	—
<b>Magnet Coils</b>	<b>Coil Suffix</b>				
120V, 60 Hz or 110V, 50 Hz	A	9-2703-1	9-2703-1	9-2703-1	9-2756-1
240V, 60 Hz or 220V, 50 Hz	B	9-2703-2	9-2703-2	9-2703-2	9-2756-2
480V, 60 Hz or 440V, 50 Hz	C	9-2703-3	9-2703-3	9-2703-3	9-2756-3
600V, 60 Hz or 550V, 50 Hz	D	9-2703-4	9-2703-4	9-2703-4	9-2756-4
208V, 60 Hz	E	9-2703-9	9-2703-9	9-2703-9	9-2756-5
277V, 60 Hz	H	9-2703-7	9-2703-7	9-2703-7	9-2756-9
208/240V, 60 Hz	J	—	—	—	—
240V, 50 Hz	K	9-2703-14	9-2703-14	9-2703-14	9-2756-13
380–415V, 50 Hz	L	99-2703-8	9-2703-8	9-2703-8	—
380V, 50 Hz	L	—	—	—	9-2756-12
415V, 50 Hz	M	—	—	—	9-2756-8
550V, 50 Hz	N	—	—	—	9-2756-14
24V, 60 Hz–24V, 50 Hz	T	—	—	—	—
24V, 60 Hz	T	9-2703-6	9-2703-6	9-2703-6	9-2756-6
24V, 50 Hz	U	9-2703-12	9-2703-12	9-2703-12	9-2756-11
32V, 50 Hz	V	9-2703-10	9-2703-10	9-2703-10	9-2756-10
48V, 60 Hz	W	9-2703-11	9-2703-11	9-2703-11	9-2756-15
48V, 50 Hz	Y	9-2703-13	9-2703-13	9-2703-13	9-2756-7
<b>Magnet Frame Armature</b>					
Lower magnet frame		17-18200	17-18200	17-18200	17-8955-2
Upper magnet frame		48-1936	48-1936	48-1936	48-1902

## NEMA Sizes 4, 5 and 6—See Contactor/Starter Nameplate to Determine Series A1 or B1

Description	NEMA Size 4 Series A1 Part Number	NEMA Size 4 Series B1 Part Number	NEMA Size 5 Series A1 Part Number	NEMA Size 5 Series B1 Part Number	NEMA Size 6 Series A1 Part Number	NEMA Size 6 Series B1 Part Number
<b>Renewal Parts Publication Number</b>	20428	20428	20429	20429	20146	20146
<b>Contact Kits</b>						
Two-pole	6-44	6-26	6-45	6-45	6-601-2	6-648
Three-pole	6-44-2	6-26-2	6-45-2	6-45-2	6-601	—
<b>Magnet Coils</b>						
	<b>Coil Suffix</b>					
120V, 60 Hz or 110V, 50 Hz	A	9-1891-1	9-1891-1	9-1891-1	9-1891-1	9-2698
240V, 60 Hz or 220V, 50 Hz	B	9-1891-2	9-1891-2	9-1891-2	9-1891-2	9-2698-2
480V, 60 Hz or 440V, 50 Hz	C	9-1891-3	9-1891-3	9-1891-3	9-1891-3	9-2698-3
600V, 60 Hz or 550V, 50 Hz	D	9-1891-4	9-1891-4	9-1891-4	9-1891-4	9-2698-4
208V, 60 Hz	E	9-1891-13	9-1891-13	9-1891-13	9-1891-13	9-2698-5
277V, 60 Hz	H	9-1891-26	9-1891-26	9-1891-26	9-1891-26	—
208/240V, 60 Hz	J	—	—	—	—	—
240V, 50 Hz	K	9-1891-20	9-1891-20	9-1891-20	9-1891-20	—
380–415V, 50 Hz	L	—	—	—	—	9-2698-6
380V, 50 Hz	L	9-1891-14	9-1891-14	9-1891-14	9-1891-14	—
415V, 50 Hz	M	9-1891-21	9-1891-21	9-1891-21	9-1891-21	—
550V, 50 Hz	N	9-1891-8	9-1891-8	9-1891-8	9-1891-8	—
24V, 60 Hz–24V, 50 Hz	T	—	—	—	—	—
24V, 60 Hz	T	9-1891-15	9-1891-15	9-1891-15	9-1891-15	—
24V, 50 Hz	U	9-1891-16	9-1891-16	9-1891-16	9-1891-16	—
32V, 50 Hz	V	9-1891-27	9-1891-27	9-1891-27	9-1891-27	—
48V, 60 Hz	W	—	—	—	—	9-2698-8
48V, 50 Hz	Y	9-1891-18	9-1891-18	9-1891-18	9-1891-18	—
<b>Overload Relays</b>						
For replacement on existing starters three-pole—ambient compensated bimetallic	10-6530-4	10-6530-4	C306DN3B	C306DN3B	C306DN3B	C306DN3B
<b>Current Transformer</b>						
For replacement on existing starters only	—	—	42-3564	42-3564	42-3598	42-3598
<b>Magnet Frame Armature</b>						
Lower magnet frame	48-1030-2	48-1030-2	48-1030-2	48-1030-2	—	—
Upper magnet frame	48-1029-4	48-1029-4	48-1029-4	48-1029-4	—	—



**NEMA Sizes 7 and 8—See Contactor/Starter Nameplate to Determine Series A1 or B1**

Description		NEMA Size 7 Series A1 Part Number	NEMA Size 7 Series B1 Part Number	NEMA Size 8 Series A1 Part Number	NEMA Size 8 Series B1 Part Number
<b>Renewal Parts Publication Number</b>		20848	20848	20849	20849
<b>Contact Kits</b>					
Two-pole		—	—	—	—
Three-pole		6-613	6-613	6-571	6-571
<b>Magnet Coils</b>	<b>Coil Suffix</b>				
120V, 60 Hz or 110V, 50 Hz	A	9-2698	9-2698	9-2654	9-2654
240V, 60 Hz or 220V, 50 Hz	B	9-2698-2	9-2698-2	9-2654-2	9-2654-2
480V, 60 Hz or 440V, 50 Hz	C	9-2698-3	9-2698-3	9-2654-3	9-2654-3
600V, 60 Hz or 550V, 50 Hz	D	9-2698-4	9-2698-4	9-2654-4	9-2654-4
208V, 60 Hz	E	9-2698-5	9-2698-5	9-2654-6	9-2654-6
277V, 60 Hz	H	—	—	—	—
208/240V, 60 Hz	J	—	—	—	—
240V, 50 Hz	K	—	—	—	—
380–415V, 50 Hz	L	—	—	—	—
380V, 50 Hz	L	9-2698-6	9-2698-6	9-2654-5	9-2654-5
415V, 50 Hz	M	—	—	—	—
550V, 50 Hz	N	—	—	—	—
24V, 60 Hz–24V, 50 Hz	T	—	—	—	—
24V, 60 Hz	T	—	—	—	—
24V, 50 Hz	U	—	—	—	—
32V, 50 Hz	V	—	—	—	—
48V, 60 Hz	W	—	—	—	—
48V, 50 Hz	Y	—	—	—	—
<b>Overload Relays</b>					
For replacement on existing starters three-pole—ambient compensated bimetallic		C306DN3B	C306DN3B	C306DN3B	C306DN3B
<b>Magnet Frame Armature</b> ①					
Lower magnet frame		—	—	—	—
Upper magnet frame		—	—	—	—

**Note**

① Contact Standard Open Control Aftermarket at 1-800-535-8992 for assistance.

#### IEC Sizes A–F—See Contactor/Starter Nameplate to Determine Series A1, B1 or C1

Description Renewal Parts Publication Number	IEC Sizes A–F		IEC Sizes A–C <sup>①</sup>		IEC Sizes D–F <sup>①</sup>	
	Series A1 Part Number	Series B1 Part Number	Series A1 Part Number	Series B1 Part Number	Series A1 Part Number	Series B1 Part Number
<b>Contact Kits</b>						
Two-pole	②	②	②	②	②	②
Three-pole	②	②	②	②	②	②
Four-pole	②	②	②	②	②	②
Five-pole	②	②	②	②	②	②
<b>Magnet Coils</b>						
	<b>Coil Suffix</b>					
120V, 60 Hz or 110V, 50 Hz	A	9-2650-1	9-2875-1	9-2875-1	9-2876-1	9-2876-1
240V, 60 Hz or 220V, 50 Hz	B	9-2650-2	9-2875-2	9-2875-2	9-2876-2	9-2876-2
480V, 60 Hz or 440V, 50 Hz	C	9-2650-3	9-2875-3	9-2875-3	9-2876-3	9-2876-3
600V, 60 Hz or 550V, 50 Hz	D	9-2650-4	9-2875-4	9-2875-4	9-2876-4	9-2876-4
208V, 60 Hz	E	9-2650-5	9-2875-5	9-2875-5	9-2876-5	9-2876-5
277V, 60 Hz	H	9-2650-13	9-2875-12	9-2875-12	9-2876-12	9-2876-12
208/240V, 60 Hz	J	—	9-2875-37	9-2875-37	9-2876-37	9-2876-37
240V, 50 Hz	K	9-2650-12	9-2875-11	9-2875-11	9-2876-11	9-2876-11
380–415V, 50 Hz	L	9-2650-6	9-2875-6	9-2875-6	9-2876-6	9-2876-6
24V, 60 Hz–24V, 50 Hz	T	—	9-2875-36	9-2875-36	9-2876-36	9-2876-36
24V, 60 Hz	T	9-2650-7	—	—	—	—
24V, 50 Hz	U	9-2650-14	9-2875-13	9-2875-13	9-2876-13	9-2876-13
32V, 50 Hz	V	9-2650-9	9-2875-16	9-2875-16	9-2876-16	9-2876-16
48V, 60 Hz	W	9-2650-8	9-2875-8	9-2875-8	9-2876-8	9-2876-8
48V, 50 Hz	Y	9-2650-10	9-2875-9	9-2875-9	9-2876-9	9-2876-9
<b>Overload Relays</b>						
For replacement on existing starters: three-pole—ambient compensated bimetallic	C306DN3B	C306DN3B	C306DN3B	C306DN3B	C306DN3B	C306DN3B
<b>Current Transformer</b>						
Transformer	—	—	—	—	—	—
<b>Magnet Frame Armature</b>						
Lower magnet frame	②	②	②	②	②	②
Upper magnet frame	②	②	②	②	②	②

#### Notes

- ① Non-encapsulated coils.
- ② Replace with complete contactor.

IEC Sizes G and H—See Contactor/Starter Nameplate to Determine Series A1 and B1

Description Renewal Parts Publication Number	IEC Size G		IEC Size H	
	Series A1 Part Number	Series B1 Part Number	Series A1 Part Number	Series B1 Part Number
	20862	22178	20862	22178
<b>Contact Kits</b>				
Two-pole	6-65-3	6-65-3	6-65-5	6-65-5
Three-pole	6-65-4	6-65-4	6-65-6	6-65-6
Four-pole	6-65-11	6-65-11	6-65-13	6-65-13
Five-pole	6-65-12	6-65-12	6-65-14	6-65-14
<b>Magnet Coils</b>				
	<b>Coil Suffix</b>			
120V, 60 Hz or 110V, 50 Hz	A	9-2703-1	9-2703-1	9-2703-1
240V, 60 Hz or 220V, 50 Hz	B	9-2703-2	9-2703-2	9-2703-2
480V, 60 Hz or 440V, 50 Hz	C	9-2703-3	9-2703-3	9-2703-3
600V, 60 Hz or 550V, 50 Hz	D	9-2703-4	9-2703-4	9-2703-4
208V, 60 Hz	E	9-2703-9	9-2703-9	9-2703-9
277V, 60 Hz	H	9-2703-7	9-2703-7	9-2703-7
240V, 50 Hz	K	9-2703-14	9-2703-14	9-2703-14
380–415V, 50 Hz	L	9-2703-8	9-2703-8	9-2703-8
24V, 60 Hz–24V, 50 Hz	T	—	—	—
24V, 60 Hz	T	9-2703-6	9-2703-6	9-2703-6
24V, 50 Hz	U	9-2703-12	9-2703-12	9-2703-12
32V, 50 Hz	V	9-2703-10	9-2703-10	9-2703-10
48V, 60 Hz	W	9-2703-11	9-2703-11	9-2703-11
48V, 50 Hz	Y	9-2703-13	9-2703-13	9-2703-13
<b>Overload Relays</b>				
For replacement on existing starters: three-pole—ambient compensated bimetallic	C306DN3B	C306DN3B	C306DN3B	C306DN3B
<b>Current Transformer</b>				
Transformer	—	—	—	—
<b>Magnet Frame Armature</b>				
Lower magnet frame	17-18200	17-1820	17-18200	17-18200
Upper magnet frame	48-1936	48-1936	48-1936	48-1936

## IEC Sizes J and K—See Contactor/Starter Nameplate to Determine Series A1 and B1

Description	IEC Size J Series A1 Part Number	IEC Size J Series B1 Part Number	IEC Size K Series A1 Part Number	IEC Size K Series B1 Part Number
Renewal Parts Publication Number	20862	22178	20862	22178
<b>Contact Kits</b>				
Two-pole	6-65-7	6-65-7	6-65-18	6-65-20
Three-pole	6-65-8	6-65-8	6-65-17	6-65-19
Four-pole	6-65-15	6-65-15	—	—
Five-pole	6-65-16	6-65-16	—	—
<b>Magnet Coils</b>				
	<b>Coil Suffix</b>			
120V, 60 Hz or 110V, 50 Hz	A	9-2703-1	9-2703-1	9-2703-1
240V, 60 Hz or 220V, 50 Hz	B	9-2703-2	9-2703-2	9-2703-2
480V, 60 Hz or 440V, 50 Hz	C	9-2703-3	9-2703-3	9-2703-3
600V, 60 Hz or 550V, 50 Hz	D	9-2703-4	9-2703-4	9-2703-4
208V, 60 Hz	E	9-2703-9	9-2703-9	9-2703-9
277V, 60 Hz	H	9-2703-7	9-2703-7	9-2703-7
240V, 50 Hz	K	9-2703-14	9-2703-14	9-2703-14
380–415V, 50 Hz	L	9-2703-8	9-2703-8	9-2703-8
24V, 60 Hz–24V, 50 Hz	T	—	—	—
24V, 60 Hz	T	9-2703-6	9-2703-6	9-2703-6
24V, 50 Hz	U	9-2703-12	9-2703-12	9-2703-12
32V, 50 Hz	V	9-2703-10	9-2703-10	9-2703-10
48V, 60 Hz	W	9-2703-11	9-2703-11	9-2703-11
48V, 50 Hz	Y	9-2703-13	9-2703-13	9-2703-13
<b>Overload Relays</b>				
For replacement on existing starters: three-pole—ambient compensated bimetallic	C306GN3B	C306GN3B	C306GN3B	C306GN3B
<b>Current Transformer</b>				
Transformer	—	—	—	—
<b>Magnet Frame Armature</b>				
Lower magnet frame	17-18200	17-18200	17-18200	17-18200
Upper magnet frame	48-1936	48-1936	48-1936	48-1936

IEC Sizes L, M and N

Description	IEC Size L Part Number	IEC Size M Part Number	IEC Size N Part Number
<b>Contact Kits</b>			
Two-pole	6-43-3	6-43	6-43-5
Three-pole	6-43-4	6-43-2	6-43-6
Four-pole	—	—	—
Five-pole	—	—	—
<b>Magnet Coils</b>			
	<b>Coil Suffix</b>		
120V, 60 Hz or 110V, 50 Hz	A	9-2756-1	9-2756-1
240V, 60 Hz or 220V, 50 Hz	B	9-2756-2	9-2756-2
480V, 60 Hz or 440V, 50 Hz	C	9-2756-3	9-2756-3
600V, 60 Hz or 550V, 50 Hz	D	9-2756-4	9-2756-4
208V, 60 Hz	E	9-2756-5	9-2756-5
277V, 60 Hz	H	9-2756-9	9-2756-9
240V, 50 Hz	K	9-2756-13	9-2756-13
380–415V, 50 Hz	L	—	—
380V, 50 Hz	L	9-2756-12	9-2756-12
415V, 50 Hz	M	9-2756-8	9-2756-8
550V, 50 Hz	N	9-2756-14	9-2756-14
24V, 60 Hz–24V, 50 Hz	T	—	—
24V, 60 Hz	T	9-2756-6	9-2756-6
24V, 50 Hz	U	9-2756-11	9-2756-11
32V, 50 Hz	V	9-2756-10	9-2756-10
48V, 60 Hz	W	9-2756-15	9-2756-15
48V, 50 Hz	Y	9-2756-7	9-2756-7
<b>Overload Relays</b>			
For replacement on existing starters three-pole—ambient compensated bimetallic	10-6530	10-6530-2	10-6530-3
<b>Current Transformer</b>			
Transformer	—	—	—
<b>Magnet Frame Armature</b>			
Lower magnet frame	17-8955-2	17-8955-2	17-8955-2
Upper magnet frame	48-1902	48-1902	48-1902

## IEC Sizes P, R and S

Description		IEC Size P Part Number	IEC Size R Part Number	IEC Size S Part Number
Renewal Parts Publication Number		22278	22278	22278
Contact Kits	Size	6-294	6-288	6-286
<b>Magnet Coils</b>	<b>Coil Suffix</b>			
120V, 60 Hz or 110V, 50 Hz	A	9-1891-1	9-1891-1	9-1891-1
200V, 50 Hz or 118V, 60 Hz	E	—	—	—
240V, 60 Hz or 220V, 50 Hz	B	9-1891-2	9-1891-2	9-1891-2
254V, 50 Hz or 277V, 60 Hz	H	—	—	—
380V, 50 Hz or 415V, 60 Hz	L	—	—	—
480V, 60 Hz or 440V, 50 Hz	C	9-1891-3	9-1891-3	9-1891-3
600V, 60 Hz or 550V, 50 Hz	D	9-1891-4	9-1891-4	9-1891-4
208V, 60 Hz	E	9-1891-13	9-1891-13	9-1891-13
277V, 60 Hz	H	9-1891-26	9-1891-26	9-1891-26
240V, 50 Hz	K	9-1891-20	9-1891-20	9-1891-20
380V, 50 Hz	L	9-1891-14	9-1891-14	9-1891-14
415V, 50 Hz	M	9-1891-21	9-1891-21	9-1891-21
24V, 60 Hz	T	9-1891-15	9-1891-15	9-1891-15
<b>Overload Relays</b>				
Reference C316 overload relays				
<b>Magnet Frame Armature</b>				
Lower magnet frame		48-1030-2	48-1030-2	48-1030-2
Upper magnet frame		48-1029-4	48-1029-4	48-1029-4

## IEC Size T, U and V

Description		IEC Size T Part Number	IEC Size U Part Number	IEC Size V Part Number
Renewal Parts Publication Number		22275	22276	22586
Contact Kits	Size	6-621	6-622	6-601
<b>Magnet Coils</b>	<b>Coil Suffix</b>			
120V, 60 Hz or 110V, 50 Hz	A	9-3006	9-3006	9-2698
200V, 50 Hz or 118V, 60 Hz	E	9-3006-5	9-3006-5	—
240V, 60 Hz or 220V, 50 Hz	B	9-3006-2	9-3006-2	9-2698-2
254V, 50 Hz or 277V, 60 Hz	H	9-3006-6	9-3006-6	9-2698-2
380V, 50 Hz or 415V, 60 Hz	L	9-3006-7	9-3006-7	9-2698-6
480V, 60 Hz or 440V, 50 Hz	C	9-3006-3	9-3006-3	9-2698-3
600V, 60 Hz or 550V, 50 Hz	D	9-3006-4	9-3006-4	9-2698-4
208V, 60 Hz	E	—	—	9-2698-5
277V, 60 Hz	H	—	—	—
240V, 50 Hz	K	—	—	—
380V, 50 Hz	L	—	—	—
415V, 50 Hz	M	—	—	—
24V, 60 Hz	T	—	—	—
<b>Overload Relays</b>				
Reference C316 overload relays				
<b>Magnet Frame Armature</b>				
Lower magnet frame		—	—	—
Upper magnet frame		—	—	—

## Technology Upgrades

This product currently listed in **Volume 5—Motor Control and Protection, CA08100006E, Tab 1.**

**IT. Electromechanical NEMA**



**NEMA Full Voltage Non-reversing Starter, Size 0**

**Product Description**

The Cutler-Hammer Intelligent Technologies® (IT.) electromechanical starter from Eaton’s electrical business consists of an IT. electromechanical contact block or contactor and an IT. electromechanical solid-state overload relay as a full voltage non-reversing (FVNR) or a full voltage reversing (FVR) device. Size 00 to Size 5 Starters are factory or field assembled.

**Product History Time Line for IT. Electromechanical NEMA**

Product	2000	2005	Present
IT. Electromechanical NEMA			

**Replacement Capabilities**

**Replacements for NEMA Contacts and Starters**

NEMA Size	Description	Catalog Number
<b>Contact Kits</b>		
1	40A	EMHCKT40 ①
1	50A	EMHCKT50 ①
2	65A	EMHCKT65 ①
2	85A	EMHCKT85 ①
2	100A	EMHCKT100 ①
3, 4	125A	EMCKT125
3, 4	160A	EMCKT160
3, 4	200A	EMCKT200
5	250A	EMCKT250
5	315A	EMCKT315
5	400A	EMCKT400
<b>Coils ②</b>		
1	Coil	EMCC
2	Coil	EMCD
3, 4	Coil	EMCE
5	Coil	EMCF
<b>DIN Rail Catch</b>		
00, 0, 1	Catch with leaf spring and pad	EMDRCB
2	Catch with leaf spring and pad	EMDRCD
<b>Lug Kits</b>		
1	Lug	EMLUGKTC
2	Lug	EMLUGKTD
3, 4	Lug	EMLUGKTE
5	Horizontal box lug kit	EMLUGKTFA
5	Vertical box lug kit	EMLUGKTFB
5	Dual lug kit	EMLUGKTFC
<b>Overload Busbars</b>		
00, 0	For contactors and starters	EMBBB
1	For starters	EMBBC
1	For reversing contactors and reversing starters	EMBBRC
2	For starters	EMBBDD
2	For reversing contactors and reversing starters	EMBBRD
3, 4	For starters	EMBBEE
3, 4	For reversing contactors and reversing starters	EMBBRE
5	Overload relay	EMBBOF

**Notes**

- ① H = Hold-Open.
- ② For reversing contactors and starters, order two.

**Technology Upgrades**

This product currently listed in **Volume 5—Motor Control and Protection, CA08100006E, Tab 2.**

#### IT. Electromechanical IEC



IEC FVNR Starter, C-Frame

#### Product Description

The Cutler-Hammer Intelligent Technologies (IT.) electromechanical starter from Eaton's electrical business consists of an IT. electromechanical contact block or contactor and IT. electromechanical solid-state overload relay as a full voltage non-reversing (FVNR) or full voltage reversing (FVR) device. A-Frame (27 mm) to F-Frame (140 mm) Starters are factory or field assembled.

#### Product History Time Line for IT. Electromechanical IEC

Product	2000	2005	Present
IT. Electromechanical IEC			

#### Replacement Capabilities

##### Replacements for IEC Contacts and Starters

Frame Size	Description	Catalog Number
<b>Contact Kits</b>		
C	40A	EMCKT40
C	50A	EMCKT50
D	65A	EMCKT65
D	85A	EMCKT85
D	100A	EMCKT100
E	125A	EMCKT125
E	160A	EMCKT160
E	200A	EMCKT200
F	250A	EMCKT250
F	315A	EMCKT315
F	400A	EMCKT400
<b>Coils ②</b>		
C	Coil	EMCC
D	Coil	EMCD
E	Coil	EMCE
F	Coil	EMCF
<b>DIN Rail Catch</b>		
B, C	Catch with leaf spring and pad	EMDRCB
D	Catch with leaf spring and pad	EMDRCD
<b>Lug Kits</b>		
C	Lug	EMLUGKTC
D	Lug	EMLUGKTD
E	Lug	EMLUGKTE
F	Horizontal box lug kit	EMLUGKTFA
F	Vertical box lug kit	EMLUGKTFB
F	Dual lug kit	EMLUGKTFC
<b>Overload Busbars</b>		
B	For contactors and starters	EMBBB
C	For starters	EMBBC
C	For reversing contactors and reversing starters	EMBBRC
D	For starters	EMBBD
D	For reversing contactors and reversing starters	EMBBRD
E	For starters	EMBBE
E	For reversing contactors and reversing starters	EMBBRE
F	Overload relay	EMBBOF

**Note**

① For reversing contactors and starters, order two.

#### Technology Upgrades

This product currently listed in **Volume 5—Motor Control and Protection, CA08100006E, Tab 2.**



**XTIEC and NEMA Power Control**



*XT Family of Contactors*

**Product Description**

Eaton’s line of **XT** Contactors and Starters includes non-reversing and reversing contactors, overload relay and a variety of related accessories. Because **XT** meets NEMA, IEC, UL, CSA, CCC and CE standards, it is the perfect product solution for applications all over the world. The compact, space saving and easy to install **XT** line of contactors and starters is the efficient and effective solution for customer applications from 7A to 2000A and NEMA 0–5.

**Product History Time Line for XT Power Control**

Product	2005	Present
XTIEC and NEMA Power Control		

**Replacement Capabilities**

**Replacement Coils**

Voltage	Coil Suffix	Catalog Number
<b>Frame C—Size 1</b>		
110/50 120/60	<b>A</b>	<b>XTCERENCOILCA</b>
110–130 Vdc	<b>AD</b>	<b>XTCERENCOILCAD</b>
220/50 240/80	<b>B</b>	<b>XTCERENCOILCB</b>
200–240 Vdc	<b>BD</b>	<b>XTCERENCOILCBD</b>
415/50 460/60	<b>C</b>	<b>XTCERENCOILCC</b>
550/50 600/60	<b>D</b>	<b>XTCERENCOILCD</b>
208/60	<b>E</b>	<b>XTCERENCOILCE</b>
230/50	<b>F</b>	<b>XTCERENCOILCF</b>
190/50 220/60	<b>G</b>	<b>XTCERENCOILCG</b>
240/50 277/60	<b>H</b>	<b>XTCERENCOILCH</b>
380/50 440/60	<b>L</b>	<b>XTCERENCOILCL</b>
400/50	<b>N</b>	<b>XTCERENCOILCN</b>
380/60	<b>P</b>	<b>XTCERENCOILCP</b>
12/50 12/60	<b>R</b>	<b>XTCERENCOILCR</b>
12–14 Vdc	<b>RD</b>	<b>XTCERENCOILCRD</b>
24/50 24/60	<b>T</b>	<b>XTCERENCOILCT</b>
24–27 Vdc	<b>TD</b>	<b>XTCERENCOILCTD</b>
24/50 42/50	<b>U</b>	<b>XTCERENCOILCU</b>
48/60	<b>W</b>	<b>XTCERENCOILCW</b>
48–60 Vdc	<b>WD</b>	<b>XTCERENCOILCWD</b>
48/50	<b>Y</b>	<b>XTCEBENCOILCY</b>
<b>Frame D—Size 2</b>		
110/50 120/60	<b>A</b>	<b>XTCERENCOILDA</b>
110–130 Vdc	<b>AD</b>	<b>XTCERENCOILDAD</b>
220/50 240/80	<b>B</b>	<b>XTCERENCOILDB</b>
200–240 Vdc	<b>BD</b>	<b>XTCERENCOILDBD</b>
415/50 480/60	<b>C</b>	<b>XTCERENCOILDC</b>
550/50 600/60	<b>D</b>	<b>XTCERENCOILDD</b>
208/60	<b>E</b>	<b>XTCERENCOILDE</b>
230/50	<b>F</b>	<b>XTCERENCOILDF</b>
190/50 220/60	<b>G</b>	<b>XTCERENCOILDG</b>
240/50 277/60	<b>H</b>	<b>XTCERENCOILDH</b>
380/50 440/60	<b>L</b>	<b>XTCERENCOILDL</b>
400/50	<b>N</b>	<b>XTCERENCOILDN</b>
380/60	<b>P</b>	<b>XTCERENCOILDP</b>
12/50 12/60	<b>R</b>	<b>XTCERENCOILDR</b>
12–14 Vdc	<b>RD</b>	<b>XTCERENCOILDRD</b>
24/50 24/60	<b>T</b>	<b>XTCERENCOILDT</b>
24–27 Vdc	<b>TD</b>	<b>XTCERENCOILDTD</b>
24/50 42/50	<b>U</b>	<b>XTCERENCOILDU</b>
48/60	<b>W</b>	<b>XTCERENCOILDW</b>
48–60 Vdc	<b>WD</b>	<b>XTCERENCOILDWD</b>
48/50	<b>Y</b>	<b>XTCERENCOILDY</b>

## Replacement Coils, continued

Voltage	Coil Suffix	Catalog Number
<b>Frame F—Size 3</b>		
110/50 120/60	A	XTCERENCOILFA
110–130 Vdc	AD	XTCERENCOILFAD
220/50 240/60	B	XTCERENCOILFB
200–240 Vdc	BD	XTCERENCOILFBD
415/50 480/60	C	XTCERENCOILFC
550/50 600/60	D	XTCERENCOILFD
208/60	E	XTCERENCOILFE
230/50	F	XTCERENCOILFF
190/50 220/60	G	XTCERENCOILFG
240/50 277/60	H	XTCERENCOILFH
380/50 440/60	L	XTCERENCOILFL
400/50	N	XTCERENCOILFN
380/60	P	XTCERENCOILFP
12/50 12/60	R	XTCERENCOILFR
24/50 24/60	T	XTCERENCOILFT
24–27 Vdc	TD	XTCERENCOILFTD
24/50	U	XTCERENCOILFU
42/50 48/60	W	XTCERENCOILFW
48–60 Vdc	WD	XTCERENCOILFWD
48/50	Y	XTCERENCOILFY
<b>Frame G—Size 4</b>		
100–120V 50/60	A	XTCERENCOILGA
110–130 Vdc	AD	XTCERENCOILGAD
190–240V 50/60	B	XTCERENCOILGB
200–240 Vdc	BD	XTCERENCOILGBD
480–500V 50/60	C	XTCERENCOILGC
380–440V 50/60	L	XTCERENCOILGL
24/50 24/60	T	XTCERENCOILGT
24–27 Vdc	TD	XTCERENCOILGTD
42–48V 50/60	W	XTCERENCOILGW
48–60 Vdc	WD	XTCERENCOILGWD
<b>Frame L—Size 5</b> <sup>①</sup>		
110–250 Vac/Vdc	A	XTCERENCOILLA
250–500V 40–60	C	XTCERENCOILLC
24–48 Vdc	TD	XTCERENCOILLTD
48–110 Vac/Vdc	Y	XTCERENCOILLY
<b>Frame M</b> <sup>①</sup>		
110–250 Vac/Vdc	A	XTCERENCOILMA
250–500V 40–60	C	XTCERENCOILMC
24–48 Vdc	TD	XTCERENCOILMTD
48–110 Vac/Vdc	Y	XTCERENCOILMY
<b>Frame N</b> <sup>①</sup>		
110–250 Vac/Vdc	A	XTCERENCOILNA
250–500V 40–60	C	XTCERENCOILNC
48–110 Vac/Vdc	Y	XTCERENCOILNY

## Replacement Contact Kits

For use with...	Catalog Number
XTAE040D–XTAE065D	XTCERENCONTACTD
XTCE185L–XTCE250L	XTCERENCONTACTL
XTCE300M–XTCE500M	XTCERENCONTACTM

## Replacement Vacuum Tube Assembly

For use with...	Catalog Number
XTCE580N	XTCERENVACT580
XTCE650N	XTCERENVACTBB0
XTCE750N	XTCERENVACT750
XTCE820N	XTCERENVACT820

## Replacement Arc Chambers

For use with...	Catalog Number
XTCE185L	XTCERENARC185
XTCE225L	XTCERENARC225
XTCE250L	XTCERENARC250
XTCE300M	XTCERENARC300
XTCE400M	XTCERENARC400
XTCE500M	XTCERENARC500

**Note**

<sup>①</sup> Electronic modules including coils.

**Advantage™**  
Originally a Westinghouse Product



Advantage Starter

**Product Description**

Setting a new standard in motor control, revolutionary in design, Advantage motor starters employ state-of-the-art technology in solving motor control application problems that have existed for ages. Customer focus group input and 66,000 man-hours of engineering ingenuity have been combined to create a motor starter that dramatically extends operating life in a physical space requirement one half the size of conventional motor starters.

**Product History Time Line for Advantage Contactors and Starters**

Size	1991	1995	2000	Present
Sizes 1–6				

**Replacement Capabilities**

**Replacements for Contact Kits and Coils**

**Contact Kits**



**Coils**



Description	Catalog Number
Replacement contact kit, size single, three-pole	<b>WCK13</b>
Replacement contact kit, size two, three-pole	<b>WCK23</b>
Replacement contact kit, size three, three-pole	<b>WCK33</b>
Replacement contact kit, size four, three-pole	<b>WCK43</b>
Replacement contact kit, size five, three-pole	<b>WCK53</b>
Replacement contact kit, size six, three-pole	<b>WCK63</b>
Size one and two, 110/120V, 60 Hz	<b>WCOIL12F</b>
Size three and four, 110/120V, 60 Hz	<b>WCOIL34F</b>
Size five and six, 110/120V, 60 Hz	<b>WCOIL56F</b>

**Advantage / A200 Series Support and Transition to Freedom-C400 Series Power Control New Technologies**

Eaton has consolidated the Advantage and Advantage+ product lines into a single offering effective July 19, 2013. This product consolidation will ensure Eaton’s ability to continue supporting the Advantage installed base.

The Advantage+ series features:

- Enhanced control board circuitry
- Same footprint as the Advantage series
- No change in accessories
- Backwards compatibility of control boards for NEMA Sizes 3–6

As a result of the consolidation, Advantage series part numbers will be replaced by the Advantage+ series.

However, please note the following:

- Replacement control boards for Advantage NEMA Sizes 1L, 1 & 2 are not interchangeable; therefore, Eaton will continue to manufacture these replacement boards
- Overload boards are no longer available. Overloads are to be replaced with a complete starter
- All other sizes will accept an Advantage+ replacement board. Please see the table below for additional details

**Replacements for Control and Overload Boards**

Offering	Replaced By
Advantage contactors (sizes 1L–6)	Advantage+ contactors (sizes 1L–6)
Advantage starters (sizes 1L–6)	Advantage+ starters (sizes 1L–6)
Advantage overload relays	Advantage+ starter
Replacement control boards (Sizes 1L, 1, 2)	No change: continue to order Advantage
Replacement control boards (Size 3, 4, 5, 6, 5DP, 6DP)	Advantage+ control boards
Accessories	No change

#### Technology Upgrades

This product is currently listed in **Volume 5—Motor Control and Protection, CA08100006E, Tab 2.**

#### C440 Electronic Overload



#### Freedom Series Starters—C440 Electronic Overload

Description (With Ground Fault Protection)	Overload Range (Amperes)	Catalog Number
NEMA Size 1 starter	1–5	AN19DN0A5G005
NEMA Size 1 starter	4–20	AN19DN0A5G020
NEMA Size 2 starter	9–45	AN19GN0A5G045
NEMA Size 3 starter	20–100	AN19KN0A5G100
NEMA Size 4 starter	28–140	AN19NN0A5G140
NEMA Size 5 starter	60–300	AN19SN0A5G300

#### C441 Motor Insight



#### Freedom Series Contactor—C441 Motor Insight

Overload Range (Amperes)	Freedom Contactor Catalog Number	Motor Insight Catalog Number (no display on unit)	Motor Insight Display Catalog Number (in the door mounting)
1–9	CN15DN3AB Size 1	C4410109NOUI	C4411 & D77E-QPIP100
5–90	CN15DN3AB Size 1	C4410590NOUI	C4411 & D77E-QPIP100
5–90	CN15GN3AB Size 2	C4410590NOUI	C4411 & D77E-QPIP100
5–90	CN15KN3A Size 3	C4410590NOUI	C4411 & D77E-QPIP100
60–135	CN15NN3A Size 4	C4410109NOUI & C441CTKIT150	C4411 & D77E-QPIP100
120–270	CN15SN3A Size 5	C4410109NOUI & C441CTKIT300	C4411 & D77E-QPIP100

#### Replacement Circuit Boards

Description	Existing Starter	Replacement Circuit Board
Standard NEMA Size 1L starter board 60 Hz	W200MLCFC	WCBSLF
Standard NEMA Size 1 starter board 60 Hz	W200M1CFC	WCBS1F
Standard NEMA Size 2 starter board 60 Hz	W200M2CFC	WCBS2F
Advantage+ NEMA Size 1L starter board 60 Hz	W+200MLCFC	W+CBSLF
Advantage+ NEMA Size 1 starter board 60 Hz	W+200M1CFC	W+CBS1F
Advantage+ NEMA Size 2 starter board 60 Hz	W+200M2CFC	W+CBS2F
Standard or Advantage+ NEMA Size 3 starter board 60 Hz	W200M3CFC or W+200M3CFC	W+CBS3F
Standard or Advantage+ NEMA Size 4 starter board 60 Hz	W200M4CFC or W+200M4CFC	W+CBS4F
Standard or Advantage+ NEMA Size 5 starter board 60 Hz	W200M5CFC or W+200M5CFC	W+CBS5F
Standard or Advantage+ NEMA Size 6 starter board 60 Hz	W200M6CFC or W+200M6CFC	W+CBS6F

**Definite Purpose**

Originally a Cutler-Hammer Product

Product History Time Line for Definite Purpose, Bulletin 9560, 9584 and 9586

Pole	Amperes	1955	1960	1965	1970	1975	1980	1985	1990	1995	2000	Present	
<b>9560 Contactors</b>													
2P, 3P, 4P	25, 30, 40		[Timeline bar]										
2P, 3P	50, 60		[Timeline bar]										
2P, 3P	75, 90					[Timeline bar]							
<b>9584 Starters</b>													
1P	30		[Timeline bar]										
	40			[Timeline bar]									
	50		[Timeline bar]										
	60		[Timeline bar]										
<b>9586 Starters</b>													
1P	30		[Timeline bar]										
	40			[Timeline bar]									
	50		[Timeline bar]										
	60		[Timeline bar]										
<b>C25 Contactors</b>													
2P, 3P, 4P	25, 30, 40							[Timeline bar]					
2P, 3P	15, 60, 75, 90							[Timeline bar]					
3P	120, 200, 300, 360							[Timeline bar]					

**Replacement Capabilities**

Contact Kits for Types 9560, 9584, 9586

Description	Contact Kit Part Number					
	Contact Kit Part Number					
	Contactor or Starter Size, Ampere Rating					
	12A Inductive 15A Resistive	25, 30A Inductive 30, 40A Resistive	40A Inductive 50A Resistive	50, 60A Inductive 60, 75A Resistive	75A Inductive 90A Resistive	90A Inductive 120A Resistive
Single-pole kit	①	6-331-3	6-331-4	—	6-331-8	6-331-8
Three-pole kit	①	—	—	6-331-39	—	—

Magnetic Coils for Types 9560, 9584 and 9586

Coil Suffix	Coil Voltage		Coil Part Number		
	60 Hz	50 Hz	Ampere Rating		
			12, 25 and 30A Inductive 15, 30 and 40A Resistive	40A Inductive 50A Resistive	50, 60, 75 and 90A Inductive 60, 75, 90 and 120A Resistive
-7	—	380	①	①	①
-47	277	—	①	①	①
-49	104-120	104-120	①	①	①
-50	208-240	208-240	①	①	①
-69	24	24	①	①	①
-72	480	480	①	①	①
-74	600	600	①	①	①

**Technology Upgrades**

Definite Purpose Technology Upgrades

Type	A25	C25	C32	B25
9560 Contactors	—	15-90A	120-350A	—
9584 Starters	—	—	—	25-40A
9586 Starters	25-60A	—	—	—

**Note**

① Replace with new Definite Purpose contactor or starter.

#### Renewal Parts

##### Renewal Contact Kits for C25 Definite Purpose Contactors

- Replace complete contactor for:
  - C25A\_
  - C25B\_
  - C25C\_
  - C25D\_

##### Renewal Contact Kits for C25 Definite Purpose Contactors

Catalog Number	Single-Pole Kit	Two-Pole Kit	Three-Pole Kit
	Part Number	Part Number	Part Number
C25FNF250	—	6-65-5	—
C25FNF350	—	—	6-65-6
C25FNF260	—	6-65-7	—
C25FNF360	—	—	6-65-8
C25FNF275	—	6-65-20	—
C25FNF375	—	—	6-65-19
C25GNF290	—	—	—
C25GNF390	—	—	—
C25HNE3120	—	—	6-43-6
C25KNE3200	—	—	6-288
C25KNE3300	—	—	6-286
C25LNE3360	—	—	6-45-2

#### Product Selection

##### AC Coils

AC Coil Voltage	Frequency	Coil Suffix	Part Number
<b>15, 25, 30 and 40A—Two- and Three-Pole (Series D1 and E1)</b>			
12	60	R	9-3185-5
24		T	9-3185-6
110/120		A	9-3185-1
208/240		B	9-3185-2
220/240	60	J	9-3185-10
440/480		C	9-3185-3
550/600		D	9-3185-4
277		H	9-3185-7
380/415	50	L	9-3185-8
<b>15, 25, 30 and 40A—Two- and Three-Pole (Series C1)</b>			
12	60	R	9-3125-5
24		T	9-3125-6
104/120		A	9-3125-1
208/240	50	B	9-3125-2
440/480		C	9-3125-3
550/600		D	9-3125-4
277	60	H	9-3125-8
380/415	50	L	9-3125-8
<b>15, 25, 30 and 40A—Two- and Three-Pole (Series D1 and E1)</b>			
12	60	R	9-3252-5
24		T	9-3252-6
110/120		A	9-3252-1
208/240		B	9-3252-2
220/240	60	J	9-3252-10
440/480		C	9-3252-3
550/600		D	9-3252-4
277		H	9-3252-7
380/415	50	L	9-3252-8
<b>50A—Two- and Three-Pole (Series D1 and E1)</b>			
12	60	R	9-3186-5
24		T	9-3186-6
110/120		A	9-3186-1
208/240		B	9-3186-2
220/240	60	J	9-3186-10
440/480		C	9-3186-3
550/600		D	9-3186-4
277		H	9-3186-7
380/415	50	L	9-3186-8

AC Coils, continued

AC Coil Voltage	Frequency	Coil Suffix	Part Number
<b>50A – Two- and Three-Pole (Series D1 and E1)</b>			
12	60	R	9-3253-5
24		T	9-3253-6
110/120		A	9-3253-1
208/240		B	9-3253-2
220/240	60	J	9-3253-10
440/480		C	9-3253-3
550/600		D	9-3253-4
277		H	9-3253-7
380/415	50	L	9-3253-8
<b>60 and 75A – Two- and Three-Pole; 25, 30 and 40A – Four-Pole</b>			
12	60	R	9-3256-5
24		T	9-3256-6
104/120		A	9-3256-1
208/240	50	B	9-3256-2
440/480		C	9-3256-3
550/600		D	9-3256-4
277	60	H	9-3256-7
380/415	50	L	9-3256-8
<b>90A – Two- and Three-Pole (Series F1)</b>			
24	50/60	T	9-3080-1
110/120		A	9-3080-2
208–220		B	9-3080-3
380–415	50/60	C	9-3080-5
277	60	H	9-3080-4
<b>120A – Three-Pole</b>			
24	50/60	T	9-2756-16
110/120		A	9-2756-1
220/240		B	9-2756-2
440/480		C	9-2756-3
550/600		D	9-2756-4
208	60	E	9-2756-5
277		H	9-2756-9
<b>200, 300 and 360A – Three-Pole</b>			
110/120	50/60	A	9-1891-1
220/240		B	9-1891-2
440/480		C	9-1891-3
550/600		D	9-1891-4
208	60	E	9-1891-13
277		H	9-1891-26

DC Operation

These DC coils have separate pick-up and seal windings. The pick-up winding must be connected to an early break normally closed auxiliary contact block and provide the magnetic force required to close the magnet. As the magnet approaches the closed position, the early break normally closed contact is opened and the holding coil is inserted in series with the pick-up winding.

The early break contact block (C320KGD1) has to be attached to the side of the contactor, taking up one of the positions available for add-on auxiliary contact blocks.

DC Coil Elementary Diagram—Contactors and Starters

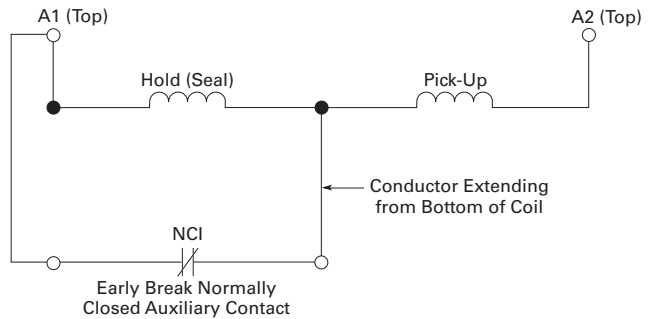

DC Coils ①

DC Coil Voltage	Coil Suffix	Part Number
<b>15, 25, 30 and 40A – Two- and Three-Pole (Series D1 and E1)</b>		
12	1R	9-3254-2
24	1T	9-3254-3
48	1W	9-3254-4
120	1A	9-3254-5
<b>50A – Two- and Three-Pole (Series D1 and E1)</b>		
12	1R	9-3255-2
24	1T	9-3255-3
48	1W	9-3255-4
120	1A	9-3255-5
<b>15, 25, 30 and 40A – Two- and Three-Pole (Series C1)</b>		
12	1R	9-3126-1
24	1T	9-3126-2
48	1W	9-3126-3
<b>60 and 75A – Two- and Three-Pole; 25, 30 and 40A – Four-Pole (Series C1)</b>		
12	1R	9-3257-1
24	1T	9-3257-2
48	1W	9-3257-3
120	1A	9-3257-4

Note

① DC coils require an early break NC auxiliary contact C320KGD1 (1NCI) or C320KGD2 (1NO-1NCI). Order separately, not included with replacement coil.

### JF Autostarter

Originally a Westinghouse Product



Start Kit—Style Number 550D409G18

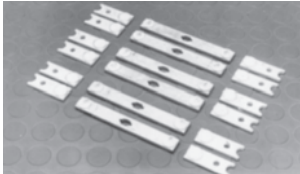

Run Kit—Style Number 550D409G19



Grid Kit—Style Number 3354D90G10

#### Product Description

Kits contain a complete set of moving contacts, stationary contacts and springs.

#### Product History Time Line for JF Autostarter

Type	1930	1935	1940	1945	1950	1955	1960	1965	1975	1985	1995	2000	Present
AF		█	█										
A				█	█	█	█						
MB							█	█					
JF							█	█	█	█	█		

#### Replacement Capabilities

##### Manual Autostarter Kits

Frame Size	Required	Start Contacts	Required	Run Contacts	Required	Grid Stack Kit
2-3	1	38A7018G12	1	38A7018G13	1	3354D90G10
4-5, 5L	1	550D409G18	1	550D409G19	1	3354D90G10
5M-5MM	1	3354D90G08	1	3354D90G09	2	3354D90G10

##### Solenoid Assembly with Coil (All Sizes)

Volt	Hz	Style ②
115	60	5264C05H01
230	60	5264C05H02
460	60	5264C05H03
575	60	5264C05H04

#### Technology Upgrades

ECN42-ECN44 reduced voltage auto-transformer starter or *IT* solid-state reduced voltage starter.

##### Notes

- ① When replacing solenoid assembly series 416C160, use adapter plate style 9917D02H01—quantity one required.
- ② These styles replace coil style 296B892G\_-. When ordering new style as replacement, customer must order adapter plate 9917D02H01—quantity one required.



**ME and MD DC Contactors**

*Originally a Westinghouse Product*

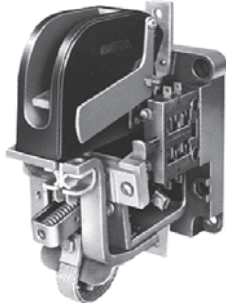

*Single-Pole, Cat. No. MD510 with L-64 Auxiliary Contact*

**Product Description**

The Cutler-Hammer ME and MD line of DC contactors were and are designed to control functions of a connected motor by starting, stopping, reversing and regulating. Motor protection is provided when the contactors are combined with an appropriate protective device such as an overcurrent relay.

**Application Description**

Typical applications for the contactor functions are as variable voltage controller disconnects, fans, pumps, conveyors, rolling mills, cranes, or anywhere a DC motor is used.

**Product History**

The Cutler-Hammer ME and MD line of DC contactors dates back to the early 1940s in East Pittsburgh, PA, where the development of the M contactors was begun by the Westinghouse Electric Corporation to be used in steel rolling mills and nicknamed “mill duty” devices. Added frame sizes were developed to complete the line in Buffalo in the late

1940s. These devices were primarily mounted on insulating plates and were rear connected for ease of wiring the motor current conductors. In the 1960s, front-mounted MD versions of the devices were developed to mount devices on steel panels because the insulating panels were expensive and difficult to manufacture.

In the late 1970s, rear-connected devices were rare and the ME contactor line was created for front connection, with a rear connection kit available and the M rear connected version discontinued. The MR normally closed line was also introduced as a standard at that time.

**Product History Time Line for M Series DC Contactors**

NEMA Size	1941	1945	1948	1952	1958	1964	1977	1978	1993	2000	2014	Present
Sizes 0–1 small frame Type M Type MD Type ME		■	■				■	■	■	■	■	■
Large frame Type M			■	■	■	■	■	■				
Size 2 large frame Type M Type ME			■	■	■	■	■	■	■	■	■	■
Sizes 3–4 Type MME Type ME			■	■	■	■	■	■	■	■	■	■
Sizes 3–4 Type M Type MD			■	■	■	■	■	■				
Size 5 front connected Type M Type MD			■	■	■	■	■	■	■	■	■	■
Rear connected Type MR								■	■	■	■	■
Sizes 6–9 front connected Type M Type MD			■	■	■	■	■	■	■	■	■	■
Rear connected Type MR									■	■	■	■

## Replacement Capabilities

## ME Series Renewal Parts—Kits

Description	1NO Pole		2NO Poles		1NC Pole		1NO/NC Pole	
	Qty.	Part Number	Qty.	Part Number	Qty.	Part Number	Qty.	Part Number
Contact kit	1	2184A10G14	2	2184A10G14	1	2184A10G14	2	2184A10G14
Arc box 10/25/50A	1	2184A10G09	2	2184A10G09	1	2184A10G09	2	2184A10G09
Arc box 100/150A	1	2184A10G10	2	2184A10G10	1	2184A10G10	2	2184A10G10
Shunt kit	1	2184A10G21	1	2184A20G16	1	2084A01G07	1	2184A11G07
Armature kit	1	2184A10G19	1	2184A20G15	1	2084A01G06	1	2184A11G06
Blowout assembly								
10A	1	2184A10G15	1	2184A20G11	1	2184A10G15	2	2184A10G15
25A	1	2184A10G16	1	2184A20G12	1	2184A10G16	2	2184A10G16
50A	1	2184A10G17	1	2184A20G13	1	2184A10G17	2	2184A10G17
110/150A	1	2184A10G18	1	2184A20G14	1	2184A10G18	2	2184A10G18
Rear connection kit	1	2184A10G08	1	2184A10G08	1	2184A10G08	1	2184A10G08

## ME Series Renewal Parts—Coils

Voltage	Part Number		
	Operating Coils 10/25/50/100/150 Ampere Sizes	Holding Coils (Lower) <sup>①</sup> — 1NO/1NC Contactors Only	
		10/25/50 Ampere Sizes	100/150 Ampere Sizes
65	30B4376G06	44A6366G10	30B4376G27
90/92	30B4376G25	44A6366G12	427C048G16
115	30B4376G07	44A6366G13	30B4376G01
125	30B4376G08	44A6366G19	30B4376G26
230/240	30B4376G09	44A6366G15	30B4376G02
250	30B4376G10	44A6366G23	30B4376G17
500	30B4376G14	N/A	N/A
550	30B4376G11	44A6366G18	30B4376G03

**Note**

<sup>①</sup> If lower coils are required, order separately.

**MR and MD Series ① Sizes 5–9 Renewal Parts—Kits**

Type MR and MD	Part Number Current
<b>Contact Kit</b>	
501/501R	26D2610G22
510	26D2610G15
601/701	26D2610G24
610/710	26D2610G16
810	26D2610G18
810R	26D2610G19
910	26D2610G20
<b>Shunt</b>	
501/501R	25A1650G02
510	25A1641G02
601	25A1666G03
610	25A1654G03
701	25A1666G04
710	25A1654G04
810/810R	25A1693G02
910	45A1425G02
<b>Arc Box</b>	
501/510	25A1646G01
601/610, 701/710	25A1662G01
810/910	25A1677G05
<b>Armature Kit</b>	
501/501R	25A1649G05
510	25A1640G05
601/701	25A1667G03
610/710	25A1655G04
810/810R	25A1694G05
910	38A2269G02
<b>Blowout Coil Assembly Kit ②</b>	
M501/510	25A1644G05
M601/610	25A1659G05
M701/710	25A1660G03
M810/810R	25A1698G03
M910	238A2273G02
<b>Blowout Coil Assembly Kit ③</b>	
M501/510	857D505G05
M601/610	857D506G08
M701/710	857D516G05
M810	857D508G07
M910	857D509G04

**Notes**

- ① MR = rear connected; MD = front connected.
- ② Type MR only.
- ③ Type MD only.

## M and MD Series Sizes 5–9—Coils

Voltage	M and MD 501		M and MD 510		M and MD 610/710	
	Part Number	Symmetrical Wiring	Part Number	Symmetrical Wiring	Part Number	Symmetrical Wiring
65	N/A	—	45A5515G11	—	—	—
90/92	N/A	—	45A5515G23	—	30B4377G17	—
115	30B4375G04	—	45A5515G01	—	30B4377G04	—
125	30B4375G24	—	45A5515G07	—	30B4377G10	—
230	30B4375G05	—	45A5515G04	—	30B4377G05	—
250	30B4375G12	—	45A5515G12	—	30B4377G07	—
550	30B4375G06	—	45A5515G05	—	30B4377G08	—

Voltage	M and MD 601/701		M and MD 810		M and MD 910	
	Part Number	Symmetrical Wiring	Part Number	Symmetrical Wiring	Part Number	Symmetrical Wiring
92	—	—	435A928G01	①	435A930G01	①
115	30B4377G23	①	435A929G01	①	L483507G01	①
115	30B4377G01	②	L482211G01	②	L483507G01	②
125	30B4377G24	①	435A966G01	①	435A967G01	①
125	30B4377G13	②	—	—	—	—
230	30B4377G01	①	L482211G01	①	L483507G01	①
230	30B4377G02	②	—	—	—	—
250	30B4377G13	①	334P064G01	①	LR549720G01	②
250	30B4377G08	②	—	—	—	—
550	30B4377G25	①	L482213G01	②	L483508G01	②
550	30B4377G03	②	—	—	—	—
600	—	—	N/A	—	L548879G01	①

Voltage	M and MD 810R		Resistor Part Number	Symmetrical Wiring	Resistor Mounting	
	Coil Part Number	Symmetrical Wiring			Part Number	Symmetrical Wiring
115	N/A	—	N/A	—	N/A	—
230	L482211G0	①	57D1336G10	③	57D1340G02	—
550	N/A	①	57D1336G12	④	57D1340G02	—

## Technology Upgrades

This product currently listed in **Volume 5—Motor Control and Protection, CA08100006E, Tab 4.**

## Notes

- ① Two coils connected in series.
- ② Two coils connected in parallel.
- ③ Two resistors connected in parallel.
- ④ Resistors connected in series.

**C80 Mill Type DC Contactors**

*Originally a Cutler-Hammer Product*

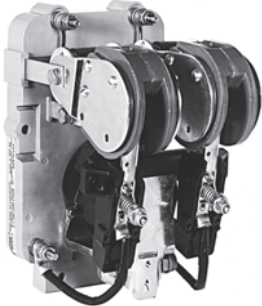

**Size 2—Two-Pole Contactor**

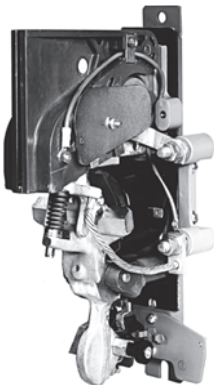

**NO Contactor**

**Product Description**

These DC mill type contactors are designed for heavy industry service and are suitable for use on moving machinery. The contactors listed in this section are for surface mounting on steel panels and front-of-panel wiring. The power stud assembly is

mounted on the side of the contactor, rather than as part of a separate mounting kit.

The contactors feature forged steel armature levers and magnet frames for superior physical strength. Self-lubricating bearings eliminate the need for lubricating the contactor.

New hot-molded arc chute assemblies contain no asbestos and have better arc extinction characteristics for longer contact life. The short stroke armature results in a mechanical life of more than 20 million operations.



**Product History Time Line for C80 Mill Type DC Contactors**

Size	1980	1985	1990	1995	2000	Present
Sizes 2 – 8		[Timeline bar spanning from 1985 to Present]				

**Note:** The C80 contactors were renumbered in 1984 from the old 6002 Series, which date back to 1919. Consult factory for old 6002 Series replacements and parts.

#### Replacement Capabilities

##### Replacement Capabilities for C80 Mill Type DC Contactors

Description	Part Numbers						
	Size 2 Single-Pole, Two-Pole, Three-Pole and Ltl® 25 and 50A	Size 3 Single-Pole NO, NC and Ltl 100A	Size 4 Single-Pole NO, NC and Ltl 150A	Size 5 Single-Pole NO, NC and Ltl 300A	Size 6 Single-Pole NO, NC and Ltl 600A	Size 6A Single-Pole NO, NC and Ltl 810A	Size 8 Single-Pole NO 1350A
<b>Set of Contact</b>	<b>Set of Contacts</b>						
 Single-pole copper	6-599	6-189	6-189	6-189-3	6-189-4	6-189-4	6-215
Single-pole silver	—	6-189-5	6-189-6	6-189-7	6-189-8	6-189-8	6-215-2
Two-pole copper	6-169-4	—	—	—	—	—	—
Three-pole copper	6-169-5	—	—	—	—	—	—
<b>Arc Shield</b>	<b>Arc Shield</b>						
 Right hand	73-2676-2	62-791	62-791	62-793	62-840	62-840	62-804
Left hand	73-2676	62-791-2	62-791-2	62-793-2	62-840-2	62-840-2	62-804
<b>Coils</b>	<b>Coils</b>						
 Single-pole NO 100V	9-1549-18	9-1583-15	9-1583-15	9-1589-10	9-1688-8	9-1688-8	9-547-7 ①
115V	9-1549-2	9-1583-2	9-1583-2	9-1589-2	9-1688-2	9-1688-2	9-547-7 ①
115V	9-1549-2	9-1583-2	9-1583-2	9-1589-2	9-1688-2	9-1688-2	9-547-7 ①
550V	9-1549-3	9-1583-3	9-1583-3	9-1589-3	9-1688-3	9-1688-3	9-547-28 ①
Single-pole NC 100V	—	9-1585-18	9-1585-18	9-967-13	9-1717-4	—	—
115V	—	9-1585-2	9-1585-2	9-967-8	9-1717-1	—	—
230V	—	9-1585-1	9-1585-1	9-967-7	9-1717-2	—	—
550V	—	9-1585-3	9-1585-3	9-967-12	9-1717-3	—	—
Single-pole Ltl ② 100V	9-1549-18	9-1583-15	9-1583-15	9-1589-10	9-1688-8	—	—
115V	9-1549-2	9-1583-2	9-1583-2	9-1589-2	9-1688-2	—	—
230V	9-1549-1	9-1583-1	9-1583-1	9-1589-1	9-1688-1	—	—
550V	9-1549-3	9-1583-3	9-1583-3	9-1589-3	9-1688-3	—	—
Two-pole 100V	9-1585-18	—	—	—	—	—	—
115V	9-1585-2	—	—	—	—	—	—
230V	9-1585-1	—	—	—	—	—	—
550V	9-1585-3	—	—	—	—	—	—
Three-pole 100V	9-1585-18	—	—	—	—	—	—
115V	9-1585-2	—	—	—	—	—	—
230V	9-1585-1	—	—	—	—	—	—
550V	9-1585-3	—	—	—	—	—	—

#### Technology Upgrades

This product currently listed in **Volume 5—Motor Control and Protection, CA08100006E, Tab 4.**

#### Notes

- ① Series resistor used with coil for voltage shown.
- ② Magnet closing coil only. If holdout coil is required, give number stamped on coil or advise Bulletin or Serial Number of controller.

**511 AC and DC Brakes**

*Originally a Cutler-Hammer Product*

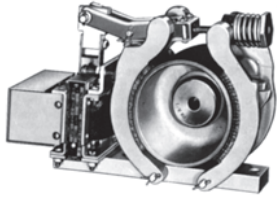

*Size 4-Inch Brake and Wheel*

**Product Description**

Cutler-Hammer Type S brakes are field-proven AC/DC brakes. For applications up to 1800 rpm/50 hp. Precision holding and stopping in 4, 5.5, 7 and 10-inch wheel sizes. With 15 standard bore sizes—straight or tapered, non-asbestos linings and off-the-shelf availability, electrically released and spring applied, providing “fail-safe” operation.

The retarding torque developed is directly proportional to the spring pressure.

Typical applications include conveyors, machine tools, printing presses, small cranes, overhead doors, dumb waiters, vacuum molding machines and carnival rides.

**Product History Time Line for 511 AC and DC Brakes**

Types	1934	1940	1950	1960	1970	1980	1990	2000	Present
4-inch Small Solenoid	[Active from 1934 to approximately 1985]								
4-inch Large Solenoid	[Active from 1934 to Present]								
5-1/2-inch Old Style	[Active from 1934 to approximately 1980]								
5-1/2-inch Updated	[Active from approximately 1985 to Present]								
7-inch	[Active from 1934 to Present]								
7-inch High Torque	[Active from approximately 1985 to Present]								
8-1/2-inch	[Active from approximately 1975 to approximately 1990]								
10-inch	[Active from 1934 to Present]								

## Replacement Capabilities

Renewal Parts for Cat. No. 511 Shoe Brakes <sup>①</sup>

Description	Coil Suffix	Part Numbers					
		4-Inch Brake 3, 10 and 15 Lb Torque	5-1/2-Inch Brake 25 and 35 Lb Torque	7-Inch Brake 50 and 75 Lb Torque	85 and 110 Lb Torque	10-Inch Brake 125 Lb Torque	160 Lb Torque
Magnet Coils	Coil Suffix						
120V, 60 Hz	-39	9-591-9	9-585-9	9-941-20	9-941-8	9-758-36	9-758-37
110V, 50 Hz	-5	9-591-9	9-585-9	9-585-9	9-941-39	9-758-26	9-758-10
120/110V, 50/60 Hz	-66	9-591-9	9-585-9	—	—	—	—
208V, 60 Hz	-45	9-591-16	9-585-33	9-941-35	9-941-45	9-758-30	9-758-31
208/240V, 50/60 Hz	-50	9-591-3	—	—	—	—	—
240V, 60 Hz	-40	9-591-10	9-585-10	9-941-15	9-941-4	9-758-2	9-758-30
220/240V, 50/60 Hz	-67	9-591-10	9-585-10	—	—	—	—
480V, 60 Hz	-41	9-591-11	9-585-16	9-941-12	9-941-6	9-758-4	9-758-20
440/480V, 50/60 Hz	-70	9-591-11	—	—	—	—	—
600V, 60 Hz	-58	9-591-12	9-585-26	9-941-32	9-941-25	9-758-13	9-758-5
550/600V, 50/60 Hz	-71	9-591-12	—	—	—	—	—
220V, 50 Hz	-6	9-591-10	9-585-10	9-585-10	9-941-29	9-758-6	9-758-2
380V, 50 Hz	-7	9-591-13	9-585-5	9-585-5	9-941-30	9-758-4	9-758-28
440V, 50 Hz	-8	9-591-11	9-585-11	9-585-11	9-941-3	9-758-7	9-758-4
550V, 50 Hz	-9	9-591-12	9-585-12	9-585-12	9-941-41	9-758-27	9-758-13
120 Vdc	-97	9-1346-3	9-1347-10	9-1347-10	9-1347-12	—	—
240 Vdc	-98	9-1346-4	9-1347-11	9-1347-11	9-1347-13	—	—
Lining kit with rivets <sup>②</sup>		6-166	6-166-2	6-166-5	6-166-5	6-166-4	
Shoe with lining		48-306 <sup>③</sup>	48-1787 <sup>③</sup>	48-1200-3 <sup>③</sup>	48-1200-3 <sup>③</sup>	24-2146-3 Inner <sup>③</sup>	24-2146-4 Outer <sup>③</sup>
Solenoid without coil	AC	88-1553-8	88-2930-4	88-1342-11	88-1342-11	17-17199	
	DC	88-521-6	88-521-5	88-521-5	88-521-5	—	
RP publication number		19320 AC	17377 AC	15475 AC	15475 AC	17379	
		13864 DC	17378 DC	15477 DC	15477 DC	—	

## Technology Upgrades

This product currently listed in **Volume 5—Motor Control and Protection, CA08100006E, Tab 2.**

- ① Parts listed are for current line of 511 brakes.
- ② Kit contains two linings and rivets for one brake.
- ③ Part number covers one shoe only.



**DPM-Contactor**

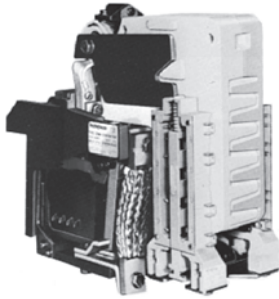

*DPM 1000 Vdc Contactor*

**Product Description**

The Cutler-Hammer DPM 1000 Vdc Definite Purpose Contactor has been designed to meet severe environmental and vibration conditions found in your worst applications. The contactor is of unit construction, assembled on a molded insulated base, providing maximum performance in minimum space.

**Product History Time Line for DPM-Contactor**

Device	1970	1980	1990	2000	Present
DPM-Contactor		[Timeline bar spanning from 1980 to Present]			

**Replacement Capabilities**

**DPM-Contactor Renewal Parts**

Description	Catalog Number
Contact kit	2131A94G10
Arc box	2131A94G03
Shunt	3534C86G01
<b>Coils</b>	
28 Vdc	2114A92G04
36 Vdc	2114A92G05
55 Vdc	2114A92G06
74 Vdc	2114A92G09
110/115 Vdc	2114A92G14
125 Vdc	2114A92G15
275 Vdc	2114A92G16
600 Vdc	2114A92G20

**Technology Upgrades**

This product currently listed in **Volume 5—Motor Control and Protection, CA08100006E, Tab 4.**

#### AVD-Contactor



2000 Vdc Contactor

#### Product Description

The AVD-Contactor is a single-pole normally open, load break, bi-directional definite purpose DC contactor. The device is rated at 1400A continuous and is capable of switching up to 2000 Vdc loads.

#### Operating Coil Characteristics

Coil Voltage	Current Draw at Nominal Voltage (± 5% at 20°C)	Catalog Number
28	1.87	9-3004-2
37	1.58	9-3004-3
74	0.79	9-3004-1
100	0.62	9-3004-5
230	0.25	9-3004-4

#### Product History

The Cutler-Hammer AVD (Advanced DC Contactor) was released for sale in 1995. The device has not gone through any significant redesigns since its introduction.

#### Product History Time Line for AVD-Contactor

Device	1993	1995	2000	Present
AVD-Contactor				

#### Replacement Capabilities

#### Replacement Coils

Coil Voltage (Vdc)	Catalog Number
28	9-3004-2
37	9-3004-3
74	9-3004-1
100	9-3004-5
230	9-3004-4

#### Auxiliary Contacts

Contact Configuration	Terminal Configuration	Catalog Number
1NO/1NC	Fast-on	10-3519-5
2NO	Fast-on	10-3519-6
2NC	Fast-on	10-3519-7
1NO/1NC	Screw type	10-6817
2NO	Screw type	10-6817-2
2NC	Screw type	10-6817-3

#### Replacement Contacts and Arc Chute

Description	Quantity Required per Contactor	Catalog Number
Stationary contact	1	23-7253
Movable contact	2	23-7255
Arc chute	1	62-1038

#### Technology Upgrades

This product currently listed in **Volume 5—Motor Control and Protection, CA08100006E, Tab 4.**

**D-Contactor**

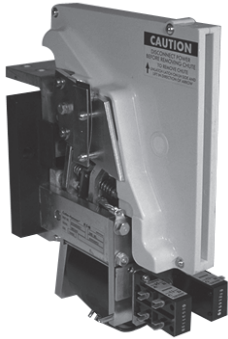

750 Vdc Contactor

**Product Description**

The D-Contactor is a single-pole normally open, load break, bi-directional definite purpose DC contactor. Two devices are available rated at 1800 and 3000A at 750 Vdc.

**Operating Coil Characteristics**

Coil Voltage	Current Draw at Nominal Voltage (± 7.5% at 20°C)	Catalog Number
12	3.96	9-1688-15
24	2.00	9-1688-7
32	1.44	9-1688-9
48	1.00	9-1688-12
74	.97	9-2064-3
100	.45	9-1688-8
115	.37	9-1688-2
230	.20	9-1688-1

**Product History**

The Cutler-Hammer D-Contactor was released for sale in early 1970s. The original device included a permanent magnet blowout coil and square main contacts. The permanent magnet blowout coil device was uni-directional or the current could only flow through the device in one direction. As such, it was essential that the polarity as marked on the power terminals be maintained. The permanent magnet blowout device is no longer offered.

The device was redesigned in the early 1980s to include round main contacts and an intermittent duty blowout coil in lieu of the permanent magnet blowout. The blowout coil device is bi-directional or current can flow through the device in either direction. Although contact life is maximized if the +terminal is at the top of the device, it is not essential that polarity be maintained. The present blowout coil device is a form, fit, function replacement for the original

permanent magnet blowout device. In addition, the present contact kits with the round contacts can be used on the original devices that employed the square main contacts. Subsequent minor product enhancements have been made with the new parts being a direct replacement for the parts that they replaced.

**Product History Time Line for D-Contactor**

Device	1970	1980	1990	2000	Present
Permanant Magnet Blowout Device	█	█			
Blowout Coil Device			█	█	█

**Replacement Capabilities**

**Replacement Coils**

Coil Voltage (Vdc)	Catalog Number
12	9-1688-15
24	9-1688-7
32	9-1688-9
48	9-1688-12
74	9-2064-3
100	9-1688-8
115	9-1688-2
230	9-1688-1

**Auxiliary Contacts**

Contact Configuration	Terminal Configuration	Catalog Number
1NO/1NC	Fast-on	10-3519-5
2NO	Fast-on	10-3519-6
2NC	Fast-on	10-3519-7
1NO/1NC	Screw type	10-6817
2NO	Screw type	10-6817-2
2NC	Screw type	10-6817-3

**Replacement Contacts, Blowout Coil and Arc Chute**

Device Rating Amperes	Main Contact Configuration	Contacts	Catalog Number
1800	Two-main	Main contacts	6-497
1800	Two-main	Arcing contacts	23-5449
3000	Four-main	Main contacts	6-496
3000	Four-main	Arcing contacts	23-5448
1800 and 3000	Two- and four-main	Blowout coil	9-2592
1800 and 3000	Two- and four-main	Arc chute	62-822

**Technology Upgrades**

This product currently listed in **Volume 5—Motor Control and Protection, CA08100006E, Tab 4.**

#### Reversing/Assignment Contactors

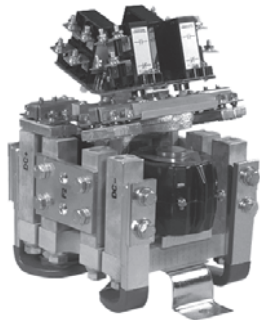

1000 Vdc Contactor

#### Product Description

The Reversing/Assignment Contactor is a double-pole, double-throw, non-load break definite purpose DC contactor. A three-position center-off and a two-position magnetically-latched configuration is available. The device is rated for 1100A, 1000 Vdc. The Reversing Contactor includes cross-over busbars for DC motor reversing applications; the Assignment Contactor omits the cross-over busbars for motor assignment applications.

#### Operating Coil Characteristics

Coil Voltage	Current Draw at Nominal Voltage ( $\pm 7.5\%$ at 20°C)	Catalog Number
24	1.60	9-1903-9
28	1.30	9-1903-1
36	1.06	9-1903-3
74	0.49	9-1903-7
110	0.33	9-1903-6
125	0.33	9-1903-4
250	0.17	9-1903-8

#### Product History

The Cutler-Hammer Reversing/Assignment Contactor was released for sale in the early 1970s. The original device incorporated a leaf spring contact assembly and square contacts. The device was redesigned in the

early 1980s to incorporate a coil spring contact assembly with round contacts. The present device is a form, fit, function replacement for the original device. In addition, the original leaf spring contact assembly devices can be

upgraded to the new coil spring contact assembly with the one-time purchase of a contact upgrade kit. The standard contact kit can then be used for subsequent contact replacements.

#### Product History Time Line for Reversing/Assignment Contactors

Device	1970	1980	1990	2000	Present
Leaf Spring Contact Assembly Device	█				
Coil Spring Contact Assembly Device		█			

#### Replacement Capabilities

##### Replacement Coils

Coil Voltage (Vdc)	Catalog Number
24	9-1903-9
28	9-1903-1
36	9-1903-3
74	9-1903-7
110	9-1903-6
125	9-1903-4
250	9-1903-8

##### Auxiliary Contacts

Contact Configuration	Terminal Configuration	Catalog Number
1NO/1NC	Fast-on	10-3519-5
2NO	Fast-on	10-3519-6
2NC	Fast-on	10-3519-7
1NO/1NC	Screw type	10-6817
2NO	Screw type	10-6817-2
2NC	Screw type	10-6817-3

#### Replacement Contacts

Device	Configuration	Catalog Number
Reversing/assignment	Three-position	6-602
Reversing/assignment upgrade kit <sup>①</sup>	Three-position	6-602-3
Magnetic latched reversing/assignment	Two-position	6-602-5

#### Technology Upgrades

This product currently listed in **Volume 5—Motor Control and Protection, CA08100006E, Tab 4.**

#### Note

<sup>①</sup> The 6-602-3 contact kit will upgrade the three-position, reversing/assignment device from the original design that incorporated a leaf spring contact structure to the present design that incorporates a coil spring contact structure. The 6-602 contact kit can then be used after the device has been upgraded for the subsequent contact replacement.

**P- and S-Contactors**

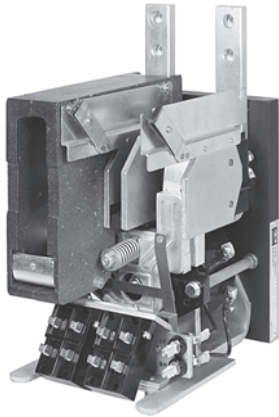

*Power Contactor*

**Product Description**

The P- and S-Contactors are single-pole normally open, load break DC contactors. Although the devices have two arc shields, they are functionally single-pole devices. The contactors typically carried a 1000 Vdc, 1000A rating and were applied in locomotive, rapid transit and high horsepower DC drive applications.

**Product History**

The Cutler-Hammer P-Contactor and S-Contactor were released for sale in the 1960s. These were single-pole DC contactors that used two arc chutes.

They typically carried a 1000 Vdc, 1200A rating and were discontinued in the mid 1980s. A few renewal parts are still available.

**Product History Time Line for P- and S-Contactors**

Device	1960	1970	1980	2000	Present
P- & S-Contactors	████████████████████				

**Replacement Capabilities**

A few renewal parts are still available.

**Auxiliary Contacts**

Contact Configuration	Terminal Configuration	Catalog Number
1NO/1NC	Fast-on	<b>10-3519-5</b>
2NO	Fast-on	<b>10-3519-6</b>
2NC	Fast-on	<b>10-3519-7</b>
1NO/1NC	Screw type	<b>10-6817</b>
2NO	Screw type	<b>10-6817-2</b>
2NC	Screw type	<b>10-6817-3</b>

**Replacement Contacts, Blowout Coil and Arc Chute**

Description	Quantity Required per Contactor	Catalog Number
Contact kit	1	<b>6-332</b>
Arc chute	2	<b>62-469</b>
Blowout coil	2	<b>62-532</b>

**Technology Upgrades**

This product can potentially be replaced with the DPM-Contactor or D-Contactor depending on the application. Please contact our Technical Resource Center for replacement device selection.

**Further Information**

Publication Number	Description
PT03304001E	Genuine Cutler-Hammer Replacement Contact Kits and Coils Wall Chart
BBF01SE	Vacuum Starters and Contactors
CA08100006E	Volume 5—Motor Control and Protection

For further replacement parts information, contact Standard Open Control Aftermarket at **1-800-535-8992**.

**Pricing Information**

*Price and Availability Digest (PAD)*

Vista/VISTALINE Discount Symbols 1CD-5C, 1CD-1C, 15CD3 and 1CD-1

#### Contents

<i>Description</i>	<i>Page</i>
<b>Low Voltage Soft Starter</b>	
Product Description, Product History, Product History Time Line . . . . .	<b>V12-T13-70</b>
Replacement Capabilities, Technology Upgrades . . . . .	<b>V12-T13-71</b>
<b>Low Voltage Adjustable Frequency AC Drives</b>	
Product Description, Product History Time Line . . . . .	<b>V12-T13-72</b>
Replacement Capabilities, Technology Upgrades . . . . .	<b>V12-T13-74</b>

#### Soft Starters



*S811+ and S801+ Soft Starter*

#### Product Description

Soft starters serve to provide reduced voltage starting, protection and control for standard three-phase induction motors. They are commonly found in applications like conveyors, compressors, extruders, pumps and blowers, etc.

Reduced voltage starting is beneficial because current and torque are reduced during the motor starting process. This reduces the electrical and mechanical shock experienced during motor starting, prolonging motor and equipment life. Soft starters also provide for maximum efficiency of the motor duty cycle by electronically sensing the motor load and reducing the voltage applied to the motor when it is running at less than full load torque.

Soft starters also provide short circuit and various types of electronic protective functions. Common features include phase loss, undervoltage, current balance, phase rotation, current limit, overtemperature, etc.

Soft start controllers are similar to reduced voltage motor starters, except they include no overload or short-circuit protection. Soft start controllers are applied in series with conventional electromechanical starters to provide the benefits of reduced voltage starting at lower cost. Electromechanical starter contact life is also improved by the soft start controller.

**Product History**

Eaton’s present line of Cutler-Hammer soft starters is the culmination of 38 years of product development. In 1958, Vectrol Engineering began manufacturing SCR Gate Driver circuitry and progressed into their own soft starter product line, known as the Vectrol Motor Starter (VMS). In 1980, Vectrol was purchased by Westinghouse. The VMS was quickly phased out of production and the Vectrol ES (Energy Saver) solid-state reduced voltage starter was introduced. The Vectrol ES combined features of automatic power factor adjustment and reduced voltage, maximizing the efficiency of the motor duty cycle. The Vectrol ES starter was actively manufactured until 1988 when the Easy-Start Motor Starter was introduced.

Eaton entered the market in 1975 with the A415, A445 and A485 product lines. By 1983, Eaton had released the A515/A545 Model A solid-state reduced voltage starter and followed up in late 1984 with the improved Model B A515. This starter used a solid-state controller, an overload relay and a six SCR full-wave power section. In 1988, Westinghouse introduced its Easy-Start and Easy-Start Jr. product lines that also used a solid-state control circuit and a six SCR full-wave power section. In 1995, the newly formed Solid-State Motor Control Division (SSMC) of the new Eaton released the Easy-Start EA Reduced Voltage Starter, combining the voltage control of SCRs with the durability of the Advantage motor starter into a uniquely small package.

The EA, EJ and the ES product lines have been replaced by the S801+ and S811+ line of soft starters. Introduced in October of 1999, the S801+ and S811+ soft starter is compact, easy to install, easy to program and is the most advanced soft starter available anywhere.

**Product History Time Line**

Product	1975	1980	1985	1990	1995	2000	Present
Cutler-Hammer A415/A445/A485	[Bar from 1975 to 1983]						
Westinghouse Vectrol VMS	[Bar from 1978 to 1980]						
Westinghouse Vectrol Energy Saver	[Bar from 1980 to 1988]						
Westinghouse Vectrol Startrol	[Bar from 1980 to 1981]						
Westinghouse Vectrol Startrol Power Miser	[Bar from 1983 to 1985]						
Cutler-Hammer A515/A545 Model A	[Bar from 1984 to 1986]						
Westinghouse Power Miser 2	[Bar from 1985 to 1989]						
Cutler-Hammer A515/A545 Model B	[Bar from 1984 to 1990]						
Westinghouse Easy-Start	[Bar from 1988 to 1995]						
Westinghouse Easy-Start 120	[Bar from 1988 to 1995]						
Cutler-Hammer Easy-Start ES	[Bar from 1988 to 1995]						
Westinghouse Power Miser 2, Model 3	[Bar from 1989 to 1991]						
Cutler-Hammer C514	[Bar from 1990 to 1995]						
Cutler-Hammer Easy-Start EC	[Bar from 1990 to 1995]						
Westinghouse Easy-Start Jr.	[Bar from 1990 to 1995]						
Westinghouse Easy-Start 100	[Bar from 1990 to 1995]						
Cutler-Hammer Easy-Start EJ	[Bar from 1990 to 1995]						
Cutler-Hammer Easy-Start EA	[Bar from 1995 to 2000]						
Cutler-Hammer S801+/S811+ Soft Starter	[Bar from 1999 to Present]						

**Replacement Capabilities**

In most cases, recommended replacement product is the Cutler-Hammer S811+ Soft Starter. Eaton’s Electrical Services & Systems (EESS) has trained technicians nationwide. See **Tab 22** in this catalog for further information about EESS capabilities.

#### Adjustable Frequency AC Drives

##### Product Description

Cutler-Hammer Adjustable Frequency Controllers (AFCs) serve to provide adjustable speed and control for standard AC induction motors. AFCs rectify the incoming AC line voltage to supply a fixed potential DC bus. An inverter section is employed to invert the DC bus voltage to an adjustable frequency output voltage. The solid-state logic section

controls the inverter and ultimately the magnitude and frequency of the output voltage to the motor. Input to the solid-state logic can be manual (from an operator type keypad) or automatic (from design features programmed into the drive logic).

The advent of microprocessor-based logic and the advancements of solid-state power technology have dramatically reduced the costs of AFCs and enhanced

their product features. This has permitted a more economical solution for adjustable speed motor applications because AFCs permit the use of standard squirrel cage induction motors instead of DC motors, which are more expensive and harder to maintain. AFCs are ideal for variable torque applications like centrifugal pumps and fans, and constant torque applications like conveyers and extruders.

#### Typical Adjustable Frequency Controller Block Diagram

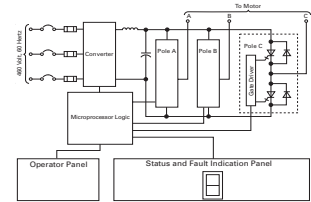

#### Product History Time Line

Product	1965	1970	1975	1980	1985	1990	1995	2000	2005	Present
Dynumatic AF-3000		█	█	█						
Dynumatic VLT-5		█	█							
Dynumatic AF-2000			█	█	█					
Dynumatic AF-300 (Responder)				█	█	█				
Dynumatic AF-6000				█	█					
Westinghouse Accutrol 100				█	█					
Dynumatic AF-7000				█	█	█	█			
Dynumatic IS-7000				█	█	█	█			
Dynumatic AF-8000				█	█					
Westinghouse Accutrol 300				█	█	█				
Westinghouse Accutrol 150				█	█					
Westinghouse Accutrol 200				█	█	█				
Westinghouse Accuflow				█	█	█				
Dynumatic AF-1000					█	█				
Dynumatic AF-5000					█	█				
Westinghouse Accutrol 110					█	█	█			
Westinghouse Accuflow Jr.					█	█	█			
Dynumatic AF-1500					█	█	█			
Westinghouse Accuflow 110					█	█	█			
Dynumatic AF-1600						█	█			
Westinghouse Accutrol 400						█	█			
Westinghouse Accutrol 700						█	█	█		
Cutler-Hammer AF97						█	█	█		
Dynumatic AF-5000+						█	█	█		
Dynumatic IS-5000+						█	█	█		
Cutler-Hammer AF93							█	█		
Cutler-Hammer AF95							█	█		
Cutler-Hammer AF91								█	█	
Cutler-Hammer SV9000								█	█	
Cutler-Hammer HV9000								█	█	
Cutler-Hammer CP9000								█	█	
Cutler-Hammer BP9000									█	█
Eaton CH MVX 9000								█	█	█
Eaton CH SVX 9000									█	█
Eaton CH HVX 9000										█



## Adjustable Frequency AC Drives—Solid-State Low Voltage

## General Information

Model	hp Range	Input Voltage	Output Devices	Output Algorithm	Control Type
VLT-5	1–5	240, 415	SCR	VVI	Analog
AF-1000	1–5 <sup>①</sup>	230, 480	Transistors	PWM	Analog
AF-1500	1–30	240, 480	Transistors	PWM	Digital
AF-1600	1–20	240, 480	IGBT	Vector PWM	Digital
AF-2000	5–10	230	SCR	VVI	Analog
AF-300	N/A	N/A	SCR	CSI	Analog
AF-3000 <sup>②</sup>	30–250	230, (460 opt)	SCR	PWM	Analog
AF-5000	5–100	380–480	Transistor	PWM	Analog
AF-5000+	5–600	380–480	Transistor	PWM	Digital
AF-6000	15–300	480	SCR	VVI	Analog
AF-7000	20–600	480, 575	Transistor	VVI	Analog
AF-8000	3 and 5	480	SCR	PWM	Analog
Accutrol 100	1–5	230	Transistor	PWM	Analog
Accutrol 110	1–75	230, 460	Transistor	PWM	Digital <sup>③</sup>
Accutrol 150	3–50	460	Transistor <sup>④</sup>	PWM	Analog
Accutrol 200	3–250	460	Transistor <sup>④</sup>	PWM	Analog
Accutrol 300	15–600	460, 575	Gate turn-off thyristor	VVI	Analog
Accutrol 400	3–150	460	Transistor	PWM	Digital
Accutrol 700	100–600	480	IGBT	Vector PWM	Digital
AF93	2–20	240, 480	Insulated gate bipolar transistor	Vector PWM	Digital
AF95	15–200	480	Insulated gate bipolar transistor	PWM	Digital
AF97	100–600	480	Insulated gate bipolar transistor	Vector PWM	Digital
AF91	Fractional to 10	240, 460	Insulated gate bipolar transistor	PWM	Digital
MVX9000	Fractional to 10	120, 240, 480	Insulated gate bipolar transistor	PWM	Digital
9000 Series	Fractional to 1100	208–575	Insulated gate bipolar transistor	PWM	Digital
SVX9000	Fractional to 2000	208–575	Insulated gate bipolar transistor	PWM	Digital

## Notes

- ① Also available with a single-phase output.
- ② Standard 220V output only.
- ③ Analog controls on pre-1988 models.
- ④ Gate Turn-off Thyristor (GTO) output devices on pre-1986 models. Transistor versions have a **T** as the third character in the style number.

## Replacement Capabilities

### Replacement Capabilities

Model	Recommended Replacement
<b>Dynatronic Adjustable Frequency Drives</b>	
VLT-5	MVX9000
AF-1000	MVX9000
AF-1500 ①	MVX9000
AF-1600	MVX9000
AF-2000	MVX9000
AF-300 (Responder)	SV/HV/CP9000
AF-3000	SV/HV/CP9000
AF-5000	SV/HV/CP9000
AF-5000+ / IS-5000+	SV/HV/CP9000
AF-6000	SV/HV/CP9000
AF-7000 / IS-7000	SV/HV/CP9000
AF-8000	AF91SV
<b>Westinghouse Adjustable Frequency Drives</b>	
Accutrol 100	MVX9000
Accutrol 110/Accuflow Jr. ①	MVX9000
Accutrol 150	SVX/HVX/CPX9000
Accutrol 200/Accuflow	SVX/HVX/CPX9000
Accutrol 300	SVX/HVX/CPX9000
Accutrol 400	SVX/HVX/CPX9000
Accutrol 700	SVX/HVX/CPX9000
<b>Cutler-Hammer Drives</b>	
AF91	MVX9000
AV91	MVX9000
AF93	SVX/HVX/CPX9000
AF95	SVX/HVX/CPX9000
AF97	SVX/HVX/CPX9000
SV9000	SVX9000
HV9000	HVX9000
CP9000	CPX9000

Eaton's Electrical Services & Systems (EESS) has trained technicians nationwide. See **Tab 22** in this catalog for further information about EESS capabilities.

### Technology Upgrades

The SVX9000 improves upon the SV9000 with modular construction and greater program capability. Clean power, 18-pulse configurations are available to meet IEEE-519 requirements for electro-magnetic compliance. The HVX9000 provides a simpler parameter set geared toward the HVAC industry, and the HVX Intellipass provides automatic bypass with 24 Vdc control. Additionally, the MVX9000 gives customers a compact, low-cost alternative to the full-featured drives of 10 hp or less. The same general controls are available, with the exception of closed-loop (encoder) control. The MVX9000 boasts a PLC-like control in the form of a step sequence program for repeated process applications. These units combine digital microprocessor control, a user-friendly keypad, IGBT technology, and a Windows®-based programmer to provide an adjustable frequency drive that can be customized to almost any application.

#### Note

① The AF-1500, Accutrol 110 and Accuflow Jr. are identical units.

Support Chart for Non-Current Vintage Products

Model	(See below for topic definitions)					
	PCB Repair	Upgrade Kits	Factory Repair	Field Service	Technical Support	Spare Parts
<b>Dynamic Adjustable Frequency Drives</b>						
VLT-5						
AF-1000						
AF-1500 ①	■		■	■	■	■
AF-1600	■		■	■	■	■
AF-2000						
AF-300 (Responder)						
AF-3000						
AF-5000	■		■	■	■	■
AF-5000+ / IS-5000+	■		■	■	■	■
AF-6000						
AF-7000 / IS-7000	■		■	■	■	■
AF-8000						
<b>Westinghouse Adjustable Frequency Drives</b>						
Accutrol 100						
Accutrol 110/Accuflow Jr. ①	■		■	■	■	■
Accutrol 150	■	■ ②	■	■	■	■
Accutrol 200/Accuflow	■	■ ②	■	■	■	■
Accutrol 300	■		■	■	■	■ ③
Accutrol 400	■		■	■	■	■
Accutrol 700	■	■	■	■	■	■
<b>Cutler-Hammer Drives</b>						
AF93						
AF95	■	■	■	■	■	■
AF97	■	■	■	■	■	■

Advanced Technology Services, 8200 N. University, Peoria, IL 61615, now provides support for these products. Their toll-free number is **1-877-645-3606**.

**Definitions**

**PCB Repair**

Printed circuit boards may be returned to Advanced Technology Services for repair. All PCBs are upgraded to the most current revision at the time of the repair.

**Upgrade Kits**

Kits are available to upgrade the basic performance of certain vintage products. Contact Advanced Technology Services for more information.

**Service Depot Repairs**

Entire assemblies may be returned to Advanced Technology Services for repair, upgrade or refurbishment.

**Field Service**

Eaton’s Electrical Services & Systems (EESS) has trained technicians nationwide. See **Tab 22** in this catalog for further information about EESS capabilities.

**Technical Support**

The trained technicians at Advanced Technology Services are available to provide assistance over the telephone.

**Spare Parts**

Advanced Technology Services maintains a complete inventory of spare parts.

**Product Support Services**

For all Product Support Services for these “legacy” products, contact Advanced Technology Services at **1-877-645-3606**. For technical support with Eaton’s current line of variable frequency drives, contact the Drives Technical Resource Center at **1-800-322-4986**.

**Notes**

- ① The AF-1500, Accutrol 110 and Accuflow Jr. are identical units.
- ② No upgrades are available for Gate Turn-off Thyristor (GTO) versions. Transistor versions are identified by a leading “A1T” or “A2T” in the model number.
- ③ GTOs are not available as spare parts for models below 100 hp.

## Contents

<i>Description</i>	<i>Page</i>
<b>Brush Type Relay Slipsyn Class 14-100 Field Application Panel</b> Product Description, Technology Upgrades . . . . .	<b>V12-T13-78</b>
<b>Brush Type Mark V Solid-State Slipsyn Class 14-100 Field Application Panel</b> Product Description . . . . .	<b>V12-T13-80</b>
Replacement Capabilities, Technology Upgrades . . . . .	<b>V12-T13-81</b>
<b>Brush Type Mark V Solid-State Slipsyn Class 14-100 Low Voltage Motor Starters</b> Product Description, Technology Upgrades . . . . .	<b>V12-T13-82</b>
<b>Brushless Type Relay Slipsyn Class 14-100 Field Application Panel</b> Product Description . . . . .	<b>V12-T13-83</b>
Replacement Capabilities, Technology Upgrades . . . . .	<b>V12-T13-84</b>
<b>Brushless Type Mark V Solid-State Slipsyn Class 14-100 Field Application Panel</b> Product Description, Technology Upgrades . . . . .	<b>V12-T13-85</b>
<b>Relay and Solid-State Slipsyn Control</b> Further Information, Pricing Information . . . . .	<b>V12-T13-86</b>

## Synchronous—Relay or Solid-State Mark V Slipsyn for Brush and Brushless Motors

### Product Description

#### *Synchronous Motors*

Polyphase synchronous motors are used primarily to obtain high pullout torques, constant operating speed, or generation of leading reactive kVA for power factor (PF) correction. To bring a motor to a constant speed, DC power is applied to a special winding in a synchronous motor. This winding is called a field coil winding and is controlled by "field control." Power (DC) for a brush type motor is usually supplied with the starter and entails using an exciter. Power (DC) for a brushless type motor is supplied by an exciter mounted on the motor.

#### *Synchronous Motor Control*

Synchronous motor "field application control" generally includes a synchronous device to apply DC power to the motor field circuit at the optimum speed. It may also include protective features such as locked rotor protection, failure to synchronize, incomplete sequence, field failure, pullout protection, etc. depending on the type of field application control selected.

#### *Relay Type vs. Solid-State Type—Mark V*

##### *Relay Type*

The relay type used the ASR synchronizing relay. Inherent in using the relay type are the problems that are associated with using contacts or mechanical closing devices such as arcing, spring and bearing deterioration and wear, dirty atmospheres, etc.

#### *Solid-State—Mark V*

The Mark V is 100% solid-state and features a "soft-turn-on" circuit that applies DC field voltage to the motor field. It enables all required functions for correct synchronization to be accomplished without the use of moving contacts or mechanical closing devices.

With the Mark V, the static exciter power supply is always supplied and is part of the "system."

Also available as a modification with the Mark V is a VAR or power factor, DC field current regulator. The regulator consists of a printed circuit board, auxiliary devices and potentiometers for adjustment.

### Product History

#### *Originally a Westinghouse Product*

##### *Synchronous Motor Control*

Brush type synchronous field control was originally available in the 1940s. Motor starters for brushless synchronous motors have been offered since the late 1960s. Synchronous motors can be medium voltage (2300–7200V) or low voltage (600V and below). A synchronous motor starter includes the basic motor control PLUS the synchronous control and protection functions. Typically, the basic motor control and the field application control are mounted in separate compartments within the starter. Ratings of synchronous control are in terms of the maximum DC field amperes required by the motor. Current ratings are 45, 90, 135, 160, 200 or 270A DC, through 6000 hp at 5 kV.

#### *Relay and Solid-State Type Control*

Relay type Slipsyn was introduced in 1947 and uses the ASR synchronizing relay. Forms of solid-state type Slipsyn were introduced in the late 1950s and early 1960s, but were not completely solid-state and had some of the operation problems that the relay type control encountered. These were called Mark I and Mark II Static Slipsyn. In 1989, the Mark V Solid-State Slipsyn field control was introduced.

#### *Medium Voltage (AMPGARD®) Starters*

The AMI AMPGARD synchronous starter (1957–1970) used a 60-inch deep enclosure with the synchronous control in the low voltage section in the front bottom two thirds of the starter enclosure. The basic motor control was located in the rear bottom two thirds of the enclosure, barriered off from the low voltage section. The AMI AMPGARD for synchronous motors used the ASR relay type control.

The LF AMPGARD (1962–1988) primarily used the ASR field application relay control. Mark I and Mark II Static Slipsyn were also used during their availability periods. The LF AMPGARD for synchronous motors included the basic induction motor control (ISO® switch, contactor and starter control) in the bottom half of the structure.

Synchronous—Relay or Solid-State Mark V Slipsyn for Brush and Brushless Motors

The upper half contained the step-down static excitation transformer with current limiting fuses, the Silicon Controlled Rectifier (SCR) type static exciter and the synchronizing control and motor field protection panel.

The SJ AMPGARD (1982–2000) family of synchronous control is very similar to the LF AMPGARD. Until the availability of the Mark V solid-state synchronous control, the SJ used the ASR relay type field control. With the advent of the Mark V, most of the synchronous starters are supplied with this type of control. In both ASR and Mark V control schemes, the synchronous gear is usually mounted in the top half of the starter.

The SL AMPGARD (2000–present) is similar to the SJ AMPGARD but uses the Mark V solid-state synchronous controller, exclusively.

**Low Voltage Synchronous Starters**

Low voltage synchronous starters are similar in nature to high voltage synchronous starters except in two regards. High voltage starters, unlike low voltage starters, must isolate the low voltage from the high voltage. The components for the field control are the same.

The second difference lies in the primary disconnect used in the starters. Low voltage starters can be supplied with no short-circuit protection, with a non-fusible disconnect, a fusible disconnect switch or with a molded-case circuit breaker. Low voltage synchronous starters were manufactured in the late 1940s with the introduction of the ASR relay, until September of 1989. In 1991, the product was reintroduced using the Mark V solid-state field control.

**Product History Time Line**

Page	Product	1945	1955	1965	1975	1985	1995	2000	Present
V12-T13-74	ASR Relay Slipsyn (Brush Type)	[Bar from 1945 to 1989]							
	Mark I Static Slipsyn (Brush Type)			[Bar from 1965 to 1975]					
	Mark II Static Slipsyn (Brush Type)				[Bar from 1975 to 1985]				
V12-T13-80	Mark V Slipsyn						[Bar from 1991 to 2000]		
V12-T13-81	Brushless Motor Control				[Bar from 1991 to Present]				

#### Relay Slipsyn Automatic Field Application Panel

##### Product Description

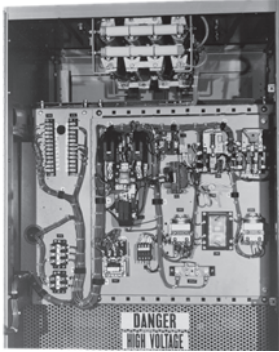

Relay Field Panel

Shaded area denotes obsolete or discontinued products and services.

##### Automatic Field Application Control

The field application panel provides Slipsyn automatic field application identical to that in complete synchronous motor starters. It is designed for use in conjunction with a primary line closing device such as a circuit breaker or a linestarter. One interlock on the primary device is used to actuate the field application control. When the motor accelerates to proper speed for pull-in, the field is automatically applied.

The controller is available for floor mounting. Floor-mounted cabinets are NEMA 1 with hinged front door and removable rear plates.

##### Typical Schematic

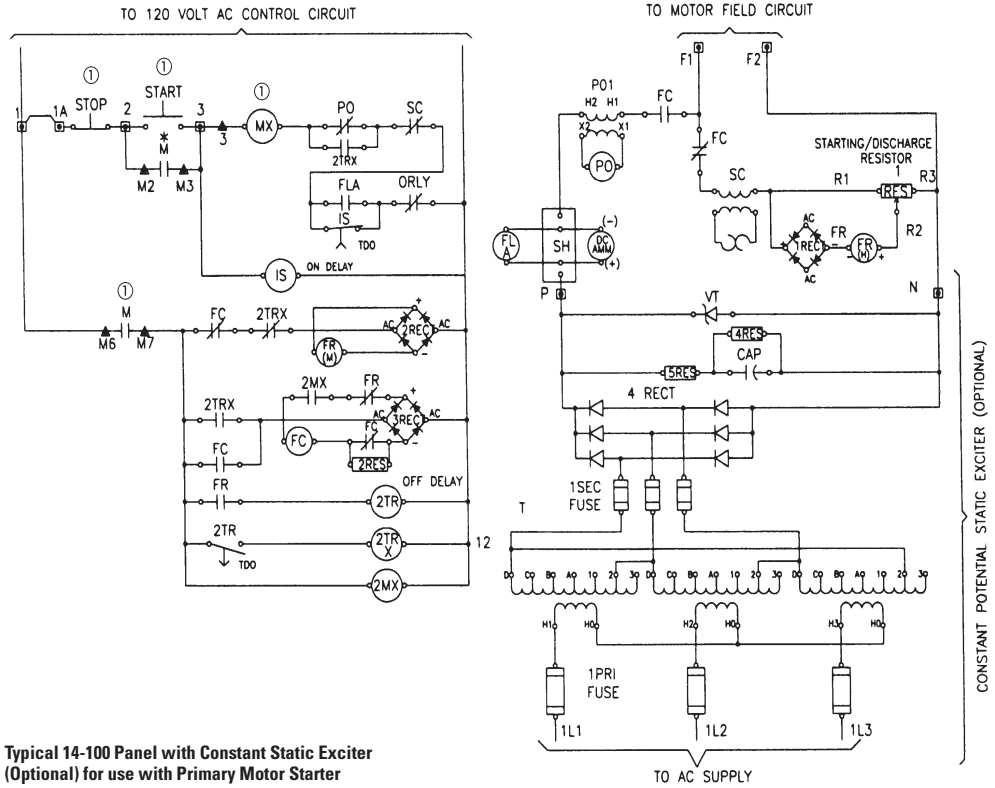

Typical 14-100 Panel with Constant Static Exciter (Optional) for use with Primary Motor Starter

##### Note

① Not supplied with 14-100 panel or static exciter.

Shaded area denotes obsolete or discontinued products and services.

The cabinets contain the following equipment:

- 1– Polarized slip frequency field application relay type ASR (FR) with half-wave rectifier (REC).
- 1– Time relay with contacts available for unloader circuit (2TR).
- 1– Pullout relay and transformer (PO).
- 1– Field contactor, two-pole (FC).
- 1– Damper winding protective relay (SC).
- 1– Starting and field discharge resistor when size permits; otherwise, provided for separate mounting (1RES).
- 1– DC field ammeter, panel type, semi-flush mounted (DC AMM).
- 1– DC field ammeter shunt (SH).
- 1– DC field failure protection (FLA).
- 2– Auxiliary relays (2TRX), (2MX).
- 1– Incomplete sequence relay (IS).

### Static Excitation Power Supply Panel

#### Constant Potential Type

Power conversion AC to DC units are designed for individual synchronous motor field excitation.

These units are convection cooled, solid-state and are completely assembled and wired as a self-contained package with a relay Slipsyn automatic field application control. The connections necessary to the external circuits are line leads, motor leads, field connections and control interconnection.

The static system consists of a convection-cooled silicon rectifier three-phase full-wave bridge assembly, a set of current limiting fuses in the secondary side of the transformer and a set of surge protecting devices. The transformer has secondary taps that are adjustable with four course taps that provide approximately 12% adjustment per tap, and three fine taps that provide 4% adjustment per tap.

#### Adjustable Potential Type

An adjustable potential exciter is similar to the constant potential exciter except that it uses SCRs and the voltage adjustment is made with a potentiometer mounted on the door.

#### Technology Upgrades

##### For Brush-Type, Relay-Panel Slipsyn (Class 14-100) Upgrades

New synchronous field controllers using the latest solid-state technology are usually available. Upgrades for primary starter and contactor components may also be available.

### Information Required from Customer for Upgrade Evaluation

1. Original assembly nameplate data including general order "GO" number as well as any drawing numbers.
2. Complete motor data including horsepower, phase, voltage/Hz, RPM, FLA, LRA, full-load DC amperes, power factor, excitation voltage, induced field amperes at 95% speed and at 0% speed, recommended discharge resistor ohms and maximum time at zero speed (locked rotor).
3. Excitation control detail such as "constant-potential" or "adjustable-potential." Adjustable-potential usually requires a field rheostat (motor field-resistor).
4. Detail on the motor's function such as the application data and other service conditions such as duty-cycle, etc.

#### Slipsyn Automatic Field Application Panel with Static Exciter

##### Product Description

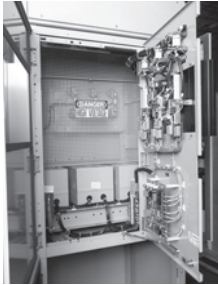

**Mark V Field Controller**

##### Automatic Field Application Control

The Slipsyn panel provides automatic field application identical to that in complete synchronous motor starters. It is designed for use in conjunction with a primary line closing device, such as a circuit breaker or a linestarter. When the motor accelerates to proper speed for pull-in, the field is automatically applied.

The solid-state Mark V Slipsyn controller will provide the following protective functions:

- A. Locked rotor protection.
- B. Incomplete sequence.
- C. Failure to synchronize.
- D. Fuse failure (Mark V).
- E. Pullout protection.
- F. DC current failure protection.

Also the application of the DC power to the motor field windings is accomplished without mechanically moving parts, and the device features a “soft-turn-on” circuit when applying DC voltage to the motor field.

Depending on the size of the solid-state application panel, the controller is available in a NEMA 1 floor-mounted enclosure or an AMPGARD type cell construction.

In both designs, a hinged front door with externally ventilated heat sinks will be provided.

The cabinets will contain the following equipment:

- 1 – Step-down exciter transformer—three-phase (TX).
- 3 – Primary fuses (3 PRI).
- 3 – Secondary fuses (3 SEC).
- 1 – “SCR” power supply panel.
- 1 – Synchronous control board (CB).
- 1 – DC ammeter—panel type (DC AMM).
- 3 – “MOV” for surge protection (MOV).
- 1 – Starting and field discharge resistor (when size permits; otherwise provided for separate mounting).
- 1 – Field failure relay (FLA).
- 1 – Incomplete SEQ Timer (FLT).
- 1 – Start timer (SYTR).
- 1 – Potentiometer (P2).

##### Typical Schematic

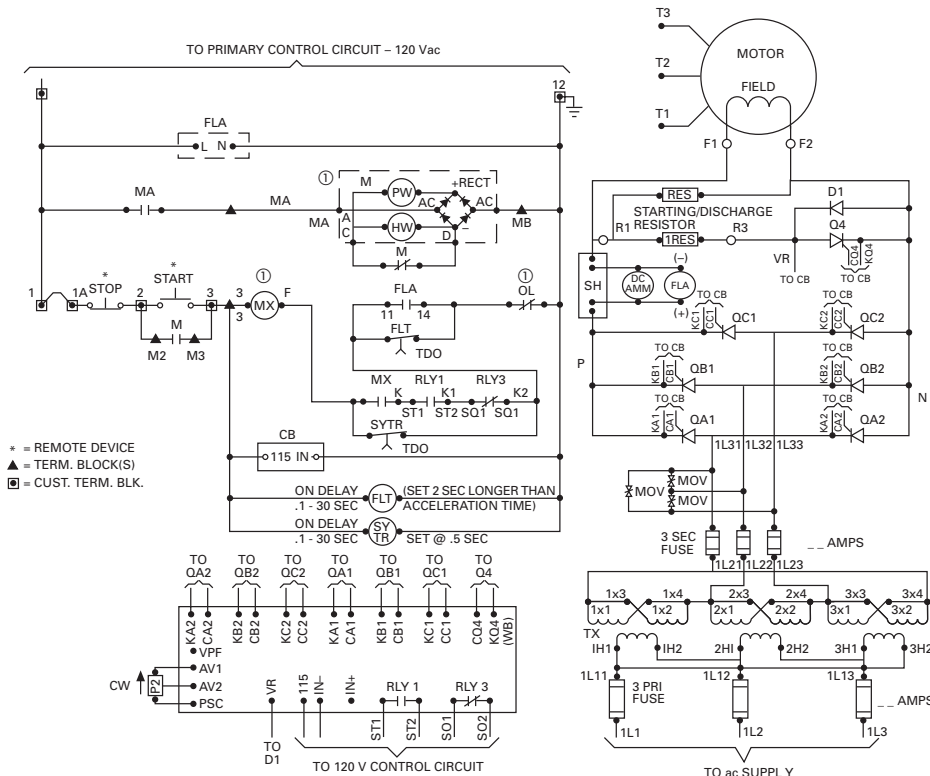

##### Note

① Not supplied with Mark V.



Synchronous—Brush Type Mark V Solid-State Slipsyn Class 14-100 Panel

Replacement Capabilities—  
Typical Solid-State  
Components



Power Module, 200A, Three Required

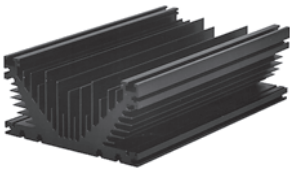

Heat Sink



MOV

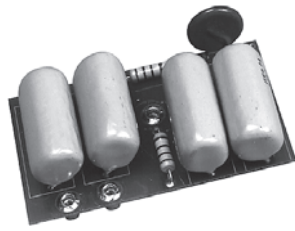

Snubber for Thyristor Stack

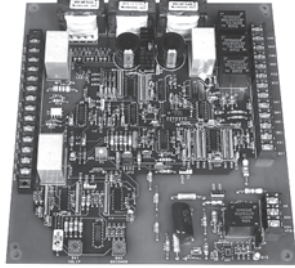

Main Synchronizing Control/  
Protection Board

**Note:** Typical solid-state components used in Mark V Slipsyn—Refer to RPD 8855S for renewal parts for synchronous control.

Field Panel with Static Exciter  
20 kW Maximum—Approximate Dimensions in Inches

Open Cell			Floor Mounted — NEMA 1		
Height	Width	Depth	Height	Width	Depth
45	36	30	90	36	30

Technology Upgrades

For Brush Type Mark V Solid-State Slipsyn (Class 14-100) Upgrades

New synchronous field controllers using the latest solid-state technology are available. Replacements and upgrades for primary starter and contactor components are also available.

Information Required from Customer for Upgrade Evaluation

1. Original assembly nameplate data including general order "GO" number as well as any drawing numbers.
2. Complete motor data including horsepower, phase, voltage/Hz, RPM, FLA, LRA, full-load DC amperes, power factor, excitation voltage, induced field amperes at 95% speed and at 0% speed, recommended discharge resistor ohms and maximum time at zero speed (locked rotor).
3. Excitation control detail such as "constant-potential" or "adjustable-potential." Adjustable-potential usually requires a field rheostat (motor field-resistor).
4. Detail on the motor's function such as the application data and other service conditions such as duty-cycle, etc.

#### Synchronous—Brush Type Mark V Solid-State Slipsyn Class 14-200 LV Motor Starter

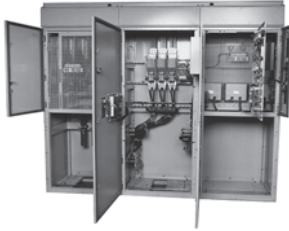

600V, NEMA Size 8, Synchronous Starter

#### Product Description

Slipsyn magnetic starters provide reliable, automatic starting of synchronous motors. Automatic synchronization is provided by the Mark V Solid-State Field Panel, which ensures application of the field at proper motor speed, and at a favorable angular position of stator and rotor poles. As a result, line disturbance resulting from synchronization is reduced and effective motor pull-in torque is increased. Application of DC power to motor field windings is accomplished without mechanically moving parts, and the device features a “soft-turn on” circuit when applying DC voltage to the motor field.

The solid-state Mark V Slipsyn controller will provide the following protective functions:

- A. Locked rotor protection.
- B. Incomplete sequence.
- C. Failure to synchronize.
- D. Fuse failure (Mark V).
- E. Pullout protection.
- F. DC current failure protection.

The cabinet will contain the following:

- 1 – Primary starter full voltage or reduced voltage.
- 1 – Ammeter shunt (when required).
- 1 – Auxiliary relay for main line contactor (when required) (MX).
- 1 – Starting and field discharge resistor (IRES).
- 1 – Current transformer for AC ammeter through NEMA Size 4; Sizes 5 and larger use three current transformers for overload relays and AC ammeter.
- 1 – Set control circuit terminal blocks.
- 3 – Type AN manual reset thermal overload relay and three heater elements (OL).
- 1 – Step-down exciter transformer—three-phase (TX).
- 3 – Primary fuses (3 PRI).
- 3 – Secondary fuses (3 SEC).
- 1 – SCR power supply panel.
- 1 – Synchronous control board (CB).
- 3 – MOV for surge protection (MOV).
- 1 – Starting and field discharge resistor (when size permits; otherwise provided for separate mounting).
- 1 – AC ammeter, panel type (AM).
- 1 – DC ammeter, panel type (DC AMM).
- 1 – Exciter field potentiometer (P2).
- 1 – Field failure relay (FLA).
- 1 – Incomplete SEQ Timer (FLT).
- 1 – Start timer (SYTR).

#### Typical Schematic Full Voltage Starter, Class 14-200, Non-Combination Type

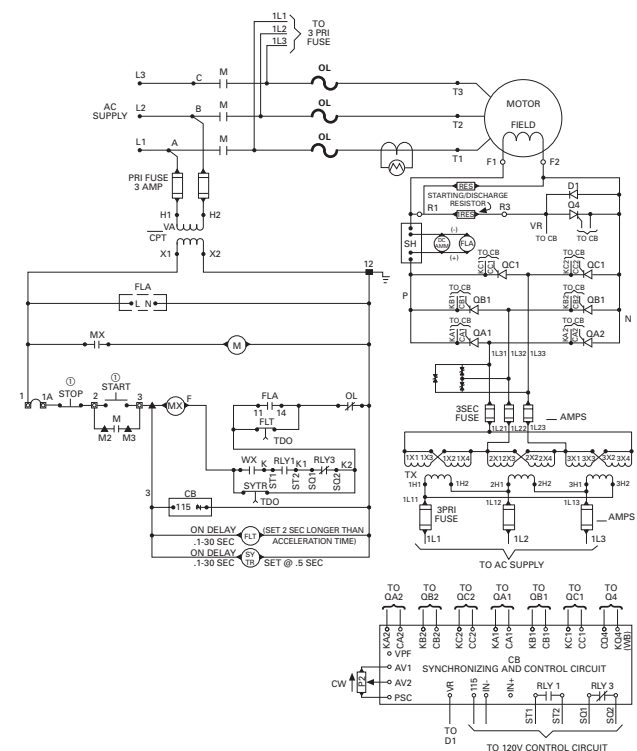

#### Technology Upgrades

##### For Brush-Type Mark V Solid-State Slipsyn (Class 14-200) Low Voltage Motor Starter Upgrades

New synchronous field controllers using the latest solid-state technology are usually available. Replacements and upgrades for primary starter and contactor components are also usually available.

##### Information Required from Customer for Upgrade Evaluation

1. Original assembly nameplate data including General Order “GO” number as well as any drawing numbers.
2. Complete motor data including horsepower, phase, voltage/Hz, RPM, FLA, LRA, full-load DC amperes, power factor, excitation voltage, induced field amperes at 95% speed and at 0% speed, recommended discharge resistor ohms and maximum time at zero speed (locked rotor).

3. Excitation control detail such as “constant-potential” or “adjustable-potential.” Adjustable-potential usually requires a field rheostat (motor field-resistor).
4. Detail on the motor’s function such as the application data and other service conditions such as duty-cycle, etc.

#### Note

① Remote device.

**Relay Slipsyn Automatic Field Application Panel**

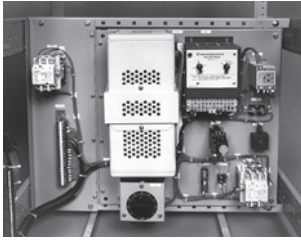

**Brushless Field Panel**

**Product Description**

This field application panel provides DC power to the exciter field and is designed for use in conjunction with a primary line closing device such as a contactor motor starter or a circuit breaker motor starter. A normally open electrical interlock on the primary device is used to actuate the field application control. This panel utilizes electromechanical devices to apply DC power to the motor exciter field circuit.

**Note:** The power rectifiers for the motor field circuit and automatic synchronizer are mounted on the synchronous motor rotor.

**Brushless Synchronous Control**

The controller can be supplied with or without enclosure. Panel mounted or open cell are suitable for mounting within other larger enclosures.

The cabinet or open panel or open cell contains the following equipment:

- 1 – Solar transformer (1 CPT).
- 1 – Power factor relay (PO).
- 1 – Auto-transformer (AT) Powerstat.
- 1 – Damper winding protection relay (DP).
- 1 – Field contactor (FC).
- 1 – Volt trap (VT).
- 1 – Rectifier (REC).
- 1 – Sequence relay (TR).
- 1 – Damper winding protection hold-in relay (DPX)—if required.
- 2 – Fuses (SEC FU), (2 SEC FU).
- 1 – DC ammeter—panel type (DC AMM).

**Typical Starter Schematic**

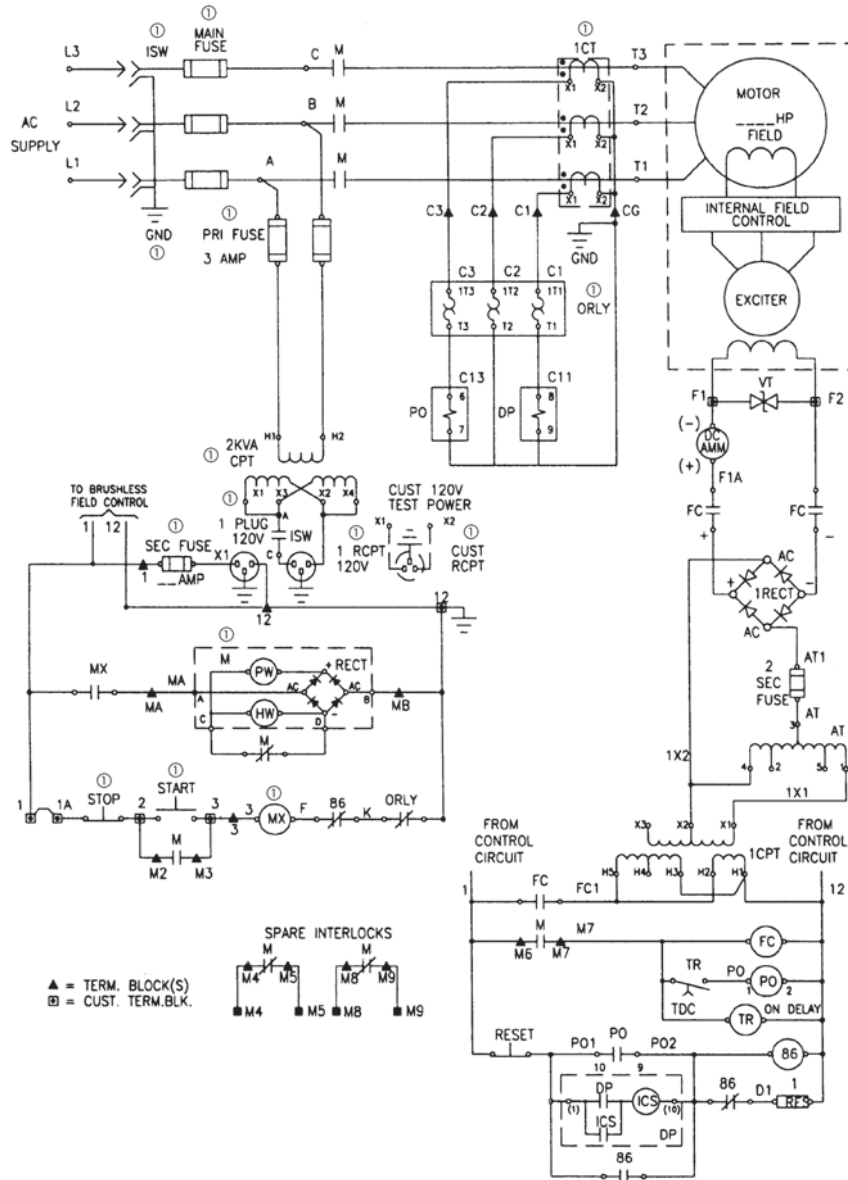

**Notes**

- ① Starter devices not supplied with field panel.
- Devices shown without a a constitute 14-100 panel.

## Replacement Capabilities—Typical Components



Rectifier



Pullout/Power Factor Relay



Damper Winding Protection Relay



Powerstat

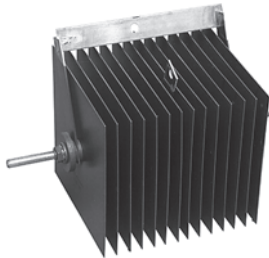

Volt Trap

**Note:** Typical components used in Relay Slipsyn Brushless Control—Refer to RPD 8855S for renewal parts for synchronous control.

## Technology Upgrades

**For Brushless-Type Relay-Panel Slipsyn (Class 14-100) Upgrades**

New synchronous field controllers using the latest solid-state technology are available. Replacements and upgrades for primary starter and contactor components are also available.

**Information Required from Customer for Upgrade Evaluation**

1. Original assembly nameplate data including general order "GO" number as well as any drawing numbers.
2. Complete motor data including horsepower, phase, voltage/Hz, RPM, FLA, LRA, full-load DC amperes, power factor, excitation voltage, induced field amperes at 95% speed and at 0% speed, and maximum time at zero speed (locked rotor).
3. Excitation control detail such as "constant-potential" or "adjustable-potential." Adjustable-potential usually requires a field rheostat (motor field-resistor).
4. Detail on the motor's function such as the application data and other service conditions such as duty-cycle, etc.

Synchronous—Brushless Type Mark V Solid-State Slipsyn Class 14-100 Panel

**Slipsyn Automatic Field Application Panel with Static Exciter**

**Product Description**

**Automatic Field Application Control**

The field application panel provides Slipsyn automatic field application identical to that in complete synchronous motor starters. It is designed for use in conjunction with a primary line closing device such as a circuit breaker or a linestarter. Automatic synchronization is provided by the Mark V solid-state field panel, which ensures application of the field at proper motor speed and at a favorable angular position of stator and rotor poles. As a result, line disturbance resulting from synchronization is reduced and effective motor pull-in torque is increased. Application of DC power to motor field windings is accomplished without mechanically moving parts, and the device features a “soft-turn-on” circuit when applying DC field voltage to the motor field.

This unit also comes standard with a VAR or power factor, DC field current regulator. The VAR regulator controls the AC reactive current flow out of the motor during varying load conditions by varying the motor field excitation. The PF regulator controls the motor power factor under varying load conditions by varying the motor field excitation. The DC field current regulator compensates for the motor field resistance as the motor field heats up by increasing the motor field voltage.

**Note:** Power factor regulation—cannot provide regulation below 50% of rated voltage and/or 25% of rated current. Regulation cannot be accomplished on light loads, i.e., less than 20% load.

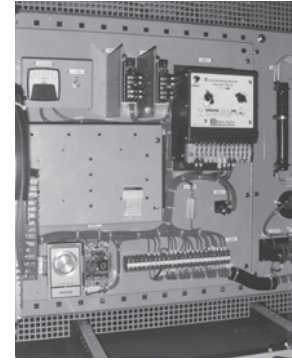
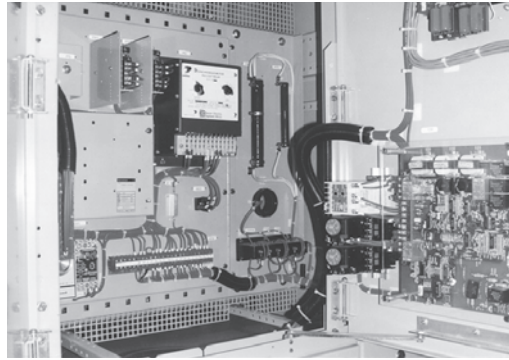

**Mark V Brushless Field Controller**

The solid-state Mark V Slipsyn controller will provide the following protective functions:

- A. Locked rotor protection.
- B. Incomplete sequence.
- C. Failure to synchronize.
- D. Fuse failure (Mark V).
- E. Pullout protection.
- F. DC current failure protection.

This control is available in a NEMA 1 floor-mounted enclosure or an AMPGARD type cell construction. In both designs, a hinged front door with externally ventilated heat sinks will be provided.

The cabinets will contain the following equipment:

- 1 – Step-down exciter transformer—three-phase (TX).
- 3 – Primary fuses (3 PRI).
- 3 – Secondary fuses (3 SEC).
- 1 – SCR power supply panel.
- 1 – Synchronous control board (CB).
- 3 – MOV for surge protection (MOV).
- 1 – AC ammeter, panel type (AM).
- 1 – DC ammeter, panel type (DC AMM).
- 4 – Potentiometer (P2, P3, P4, P5).

- 1 – Field failure relay (FLA).
- 1 – Incomplete SEQ Timer (FLT).
- 1 – Start timer (SYTR).
- 1 – MP-3000 without RTD module.
- 1 – DP-4000.
- 1 – VAR/PF/DC field current board (CB1).
- 1 – Auto/manual selector switch (SSI).
- 1 – Timer (AUTO).
- 1 – Pullout relay (PO).

**Approximate Dimensions in Inches**

Open Cell			Floor Mounted—NEMA 1		
Height	Width	Depth	Height	Width	Depth
45	36	30	90	36	30

**Technology Upgrades**

**For Brushless-Type Mark V Solid-State Slipsyn (Class 14-100) Upgrades**

New synchronous field controllers using the latest solid-state technology are available. Replacements and upgrades for primary starter and contactor components are also available.

**Information Required from Customer for Upgrade Evaluation**

1. Original assembly nameplate data including general order “GO” number as well as any drawing numbers.
2. Complete motor data including horsepower, phase, voltage/Hz, RPM, FLA, LRA, full-load DC amperes, power factor, excitation voltage, induced field amperes at 95% speed and at 0% speed, and maximum time at zero speed (locked rotor).
3. Excitation control detail such as “constant-potential” or “adjustable-potential.” Adjustable-potential usually requires a field rheostat (motor field-resistor).
4. Detail on the motor’s function such as the application data and other service conditions such as duty-cycle, etc.

**Identifying Renewal Parts**

Renewal parts data for the entire history of synchronous control is contained in RPD 8855S, which provides the proper identification of standard parts that may be required under normal operation:

1. Identify the design of synchronous control (Relay, Mark I, Mark II or Mark V Slipsyn) from the synchronous panel nameplate.
2. Now that you have identified the type of the synchronous control, determine from the photographs in RPD 8855S which parts are required and identify them by style number.
3. Because many starters are supplied to meet specific customer requirements, other parts not shown in RPD 8855S might occasionally be needed. Price and availability of parts not listed may be obtained by providing a complete description of the part, along with the complete data on the starter nameplate, which is found in the low voltage area. Be sure to include the following: ratings, shop order and diagram reference.

**Further Information**

Publication Number	Description
RP04304009E	Common Replacement Parts for Mark V Synchronous Field Controller
RPD 8855S	Renewal Parts Data for Synchronous Control
TD.48A.01.T.E	Descriptive Bulletin for AMPGARD Starters
IL 17097	Instruction Leaflet for Relay Slipsyn
IB 48008	Instruction Leaflet for Solid-State Slipsyn
IB 48009	Instruction Leaflet for Mark V VAR/PF/DC Field Current Regulator

**Pricing Information**

*Price and Availability Digest (PAD)*

**Contents**

<i>Description</i>	<i>Page</i>
<b>AMI AMPGARD</b> Product Description, Technology Upgrades . . . . .	<b>V12-T13-91</b>
<b>LF Air AMPGARD</b> Product Description, Replacement Capabilities, Technology Upgrades . . . . .	<b>V12-T13-92</b>
<b>SL and SJ Vacuum AMPGARD</b> Product Description, Replacement Capabilities . . . . .	<b>V12-T13-94</b>
Technology Upgrades . . . . .	<b>V12-T13-95</b>
Further Information, Pricing Information . . . . .	<b>V12-T13-99</b>

**AMPGARD**

*Originally a Westinghouse Product*



**AMPGARD Motor Control Assembly**



*(AMI Vintage), 5000V 200A, 2500V 200A, 2500/5000V 400A (LF-Air Vintage)*

**Product Description**

A medium voltage starter is an assembly used to control and protect an alternating current (AC) electric motor rated at 2300, 4160 or 7200V. The controlling function is provided by a magnetically held contactor. The overload protection is provided by an overload relay of some type, and the short-circuit protection is provided by a non-load break fused disconnect switch. 400A starters are typically mounted two-high in a 90-inch high enclosure. 800A starters are mounted one-high.

**Product History**

The AMPGARD starter line originated in the early 1940s and has undergone two major design changes and one major evolution.

Prior to the introduction of the AMI, the AMPGARD was simply a fused motor starter in a cabinet with no disconnect switch. It was built in the early 1940s through the 1950s. There was no standard design.

The AMI AMPGARD (1950s through 1960s) was a standardized design. The AMI was one starter per structure designed to cover all ratings and incorporated a disconnect switch (ISO-Switch) in the upper compartment and either an air or oil contactor in the bottom compartment.

In the mid 1960s, a full line of starters was introduced, tailored to the horsepower requirement of the motor and using the LF air contactor. The starter incorporated the ISO-Switch and power fuses into the same cell as the air contactor. Starters were one-, two- or three-high per structure, depending on the rating required. The ratings of the LF AMPGARD were 200, 400 and 700A.

Cutler-Hammer manufactured MV motor control from 1966–1976. It was Bulletin 9950 Series, stacked two-high, with no specific trade name (such as AMPGARD).

The manufacturing facility moved from Buffalo, NY, to Asheville, NC, in 1978.

In the 1980s with the advent of vacuum technology, the LF air contactor design was discontinued. The SJ vacuum contactor was matched with a fused isolation switch. Now two current ratings are offered — 400 amperes, one- or two- high, and 800 amperes, one-high. Starters are sized per the motor horsepower and full load amperes.

#### Product History Time Line

Page	Product	1945	1950	1955	1960	1965	1970	1975	1980	1985	1990	1995	2000	2005	Present
Classic AMPGARD	V12-T13-89 AMPGARD OIL AMPGARD AH AMI AMPGARD	█		█		█		█		█		█		█	
	V12-T13-90, V12-T13-91 LF Air – 25L2 200A – 50L2 200A – 25/50L4 400A – 25/50L7 700A	█		█		█		█		█		█		█	
	V12-T13-92 SJ Vacuum – SJA 400A (roll-out) – SJA 800A (roll-out) – SJS 400A (slide-out)	█		█		█		█		█		█		█	
V12-T13-92 SL Vacuum – SLW 400A (roll-out) – SLF 400A (slide-out)	█		█		█		█		█		█		█		
Next Generation AMPGARD	V12-T13-94 SLB (bolted) SLS (stab)	█		█		█		█		█		█		█	

#### Catalog Number Selection

##### Old Catalog Numbering System—Contactors Only

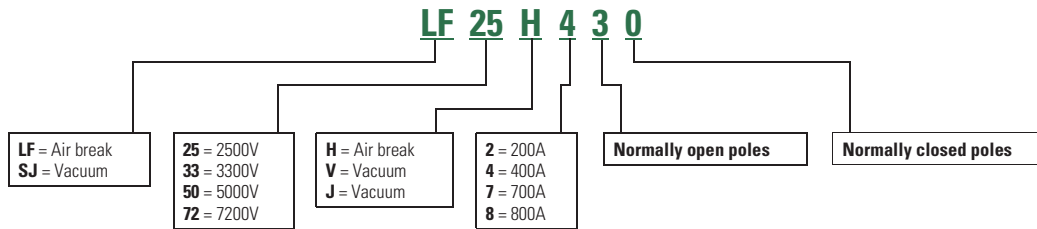

##### Old Catalog Numbering System—Contactors Only

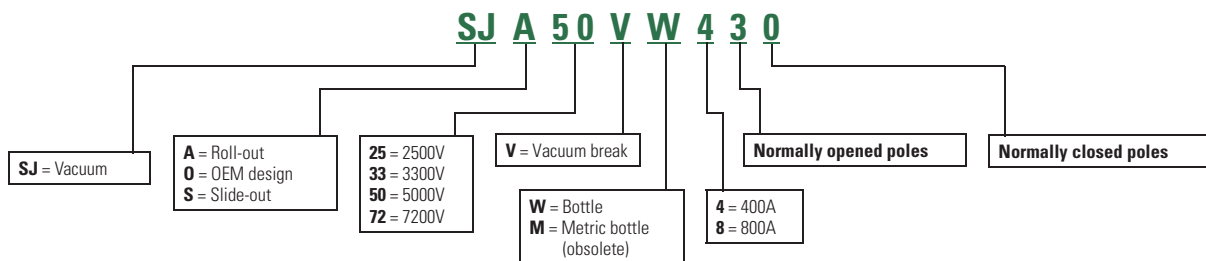

##### Old Catalog Numbering System—Starters (with Isolating Switch, Power Fuses, Contactor, etc.)

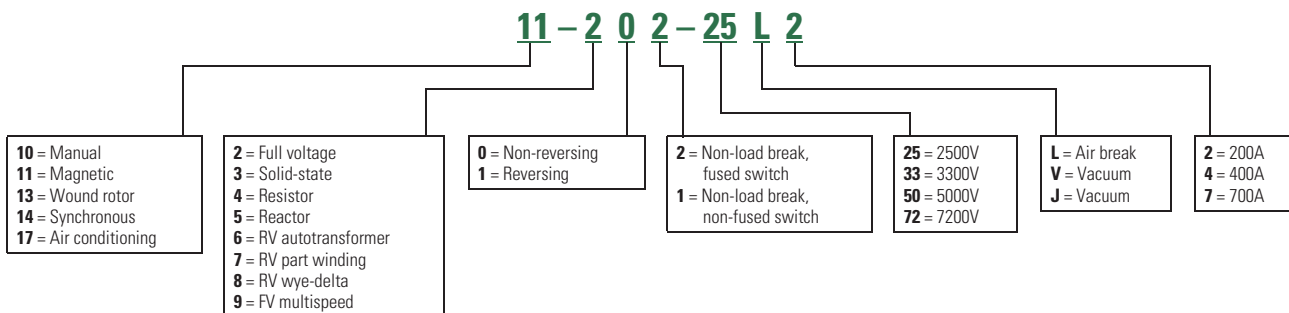



Old Catalog Numbering System—Starters (with Isolating Switch, Power Fuses, Contactors, etc.)

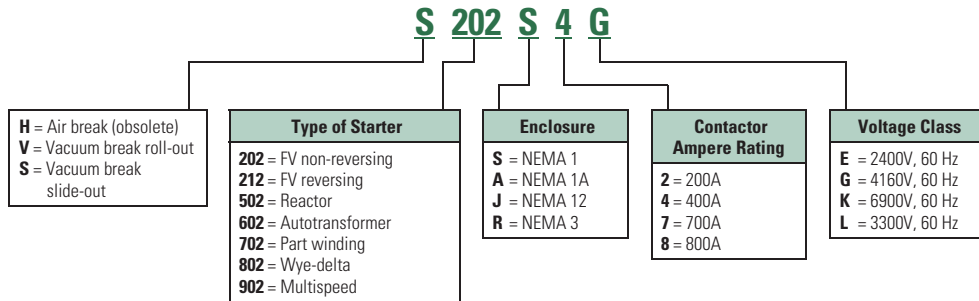

Old Catalog Numbering System—Contactors Only

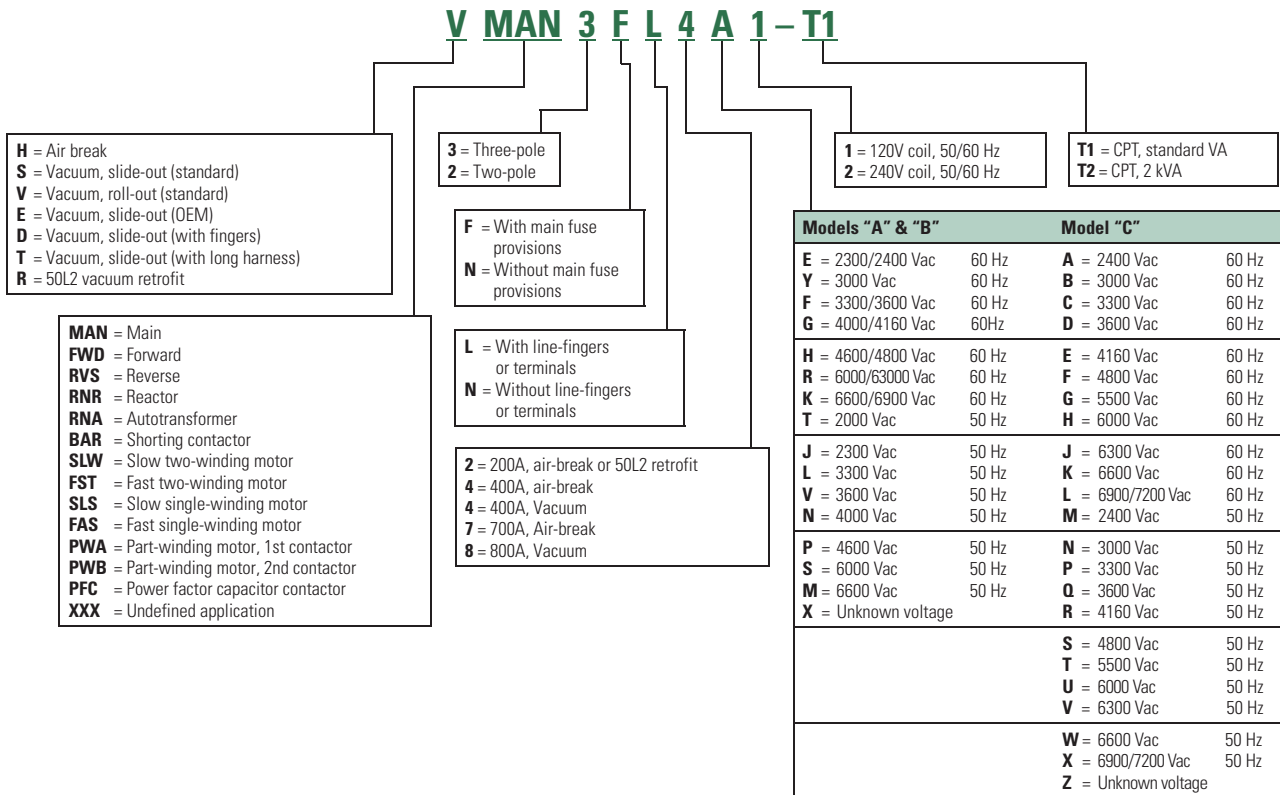

#### New Catalog Numbering System—SL Contactors Only

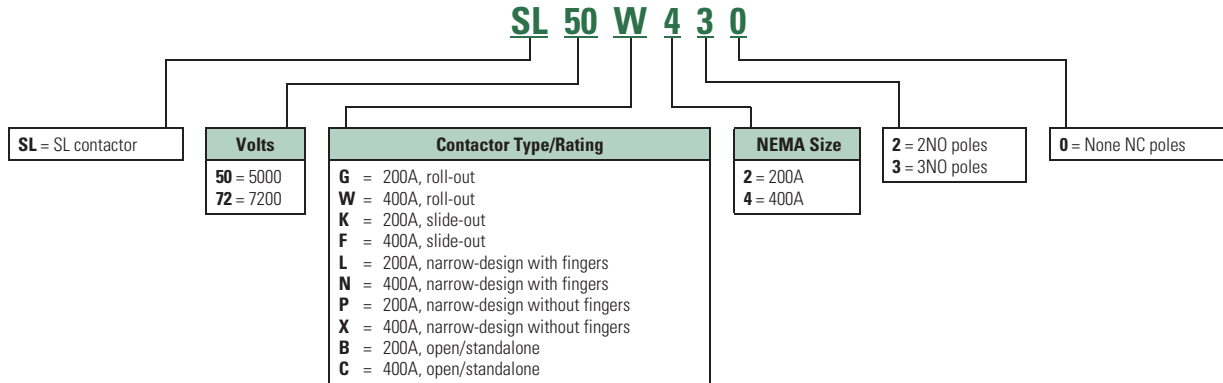

#### New Catalog Numbering System—SL Starters Only

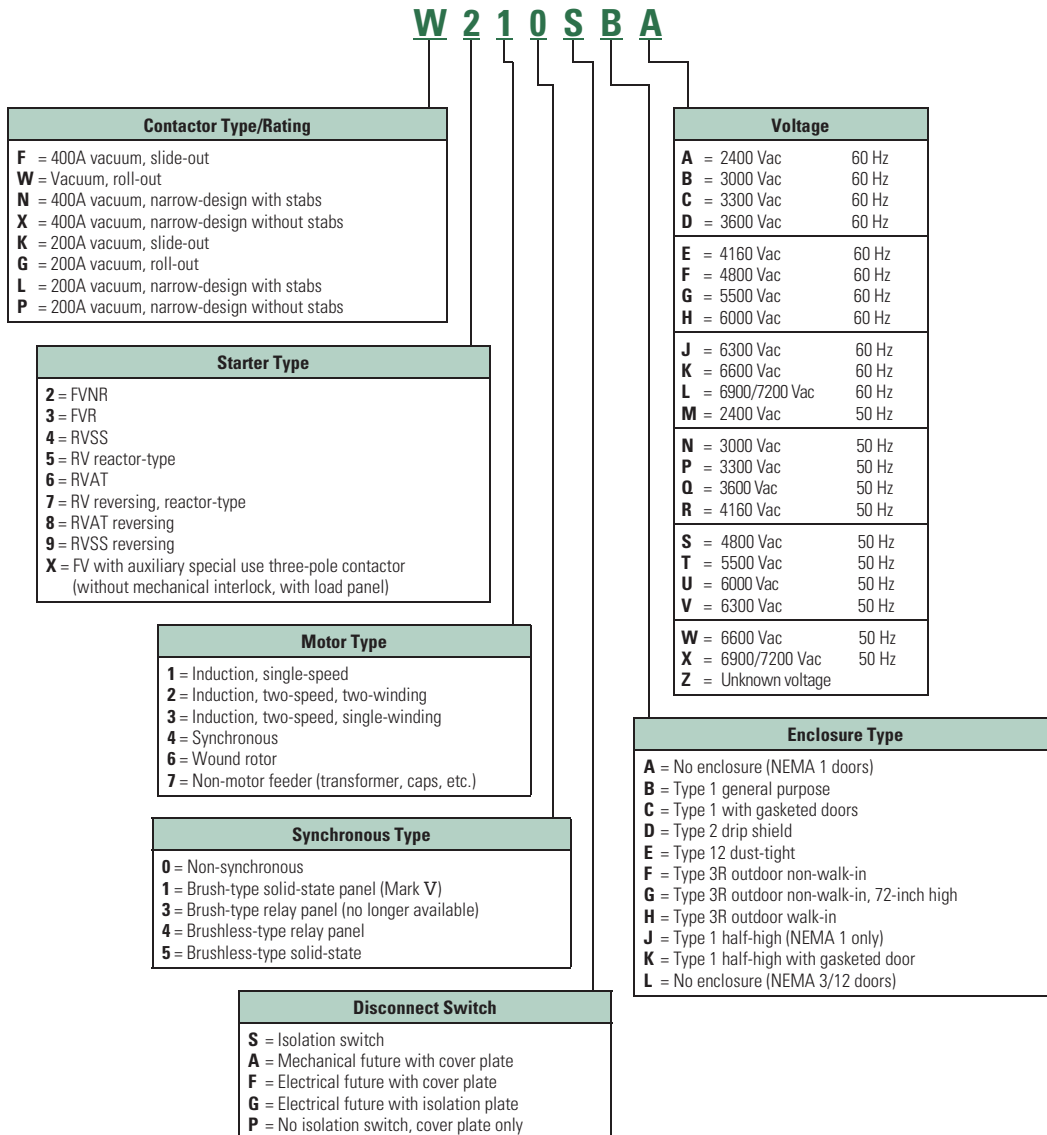

**AMI AMPGARD**

*Originally a Westinghouse Product*



AMI AMPGARD Starter

**Product Description**

The AMI design AMPGARD starter introduced in 1957 was a complete line of starters for magnetic control of squirrel cage, wound rotor and synchronous motors. The AMI was the first front-accessible starter and was available with air break (Type H) or oil immersed (Type K) contactors. The standard AMI for full voltage starting was 30 inches deep, 38 inches wide and 90 inches high. All components were accessible from the front through three doors that opened into separate compartments. The top compartment enclosed the isolating switch and current limiting power fuses. The middle compartment enclosed the AC low voltage control panel and behind it the CTs. The bottom compartment housed the contactor.

**Note:** The pre-AMI design was a rear-access assembly with two compartments—current limiting fuses on the top and the contactor below.

**Ratings (Maximum)**

400A 1500 hp at 2500V;  
2500 hp at 5000V.

**Chronology**

The AMI design AMPGARD was manufactured from 1957 until 1970 at the General Control Division in Buffalo, NY, and Westinghouse Manufacturing and Repair (M&R) facilities around the country. The air contactor was available through 1966. The oil contactor was available through 1970.

**Replacement Capabilities**

The AMI vintage is obsolete but upgrading to the latest vacuum technology with a cell-retrofill solution is available. See Technology Upgrades for further information.

**Add-On Structure**

New add-on vacuum structures as an extension to the AMI type structure may be connected directly to the main bus without a transition section using special bus links. Contact your local Eaton Field Sales office.

**Technology Upgrades**

**Standard AMI 36-Inch Wide Vacuum Starter Cell-Retrofill**

This kit includes a standard full-voltage non-reversing vacuum starter in a welded cell assembly with horizontal top barriers and deep flanged doors. Optional components include a new electronic motor protection relay MP-3000 and electronic meter DP-4000. It will retrofit the AMI designs that are at least 36 inches wide and 30 inches deep. The cell is 45 inches high.

**Narrow AMI 30-Inch Wide Vacuum Starter Cell-Retrofill**

This kit includes a standard full-voltage non-reversing vacuum starter in a welded cell assembly with horizontal top barriers and deep flanged doors. Optional components include a new electronic motor protection relay MP-3000 and electronic meter DP-4000. It will retrofit the AMI designs that are at least 30 inches wide and 30 inches deep. The cell is 58 inches high.

**Standard AMI 36-Inch Wide Vacuum Starter Cell-Retrofill Style Number**

Description	Style Number
SJ Contactor	2147A95G41
SL Contactor	2147A95G61

**Narrow AMI 30-Inch Wide Vacuum Starter Cell-Retrofill Style Number**

Description	Style Number
SJ Contactor	2147A95G42
SL Contactor	2147A95G62

**AMI Starter Cell-Retrofill**

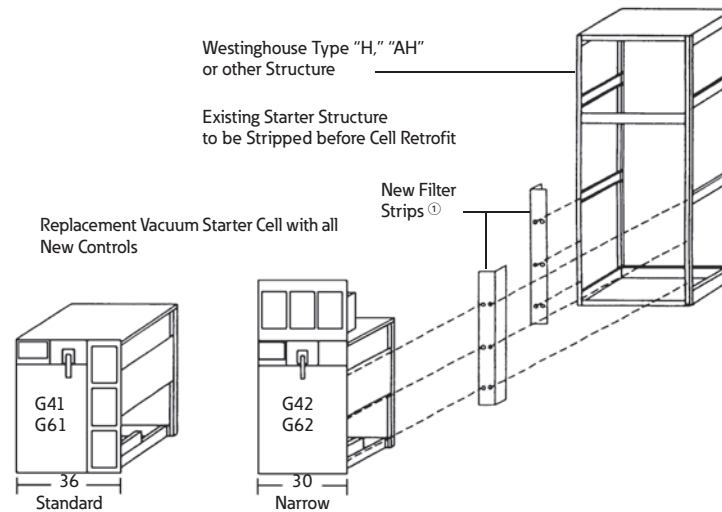

**Note**

① Upper filler cover may require field modification.

#### LF Air AMPGARD

*Originally a Westinghouse Product*

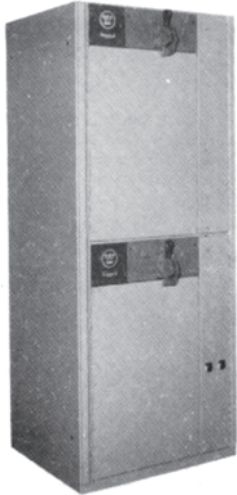

*The LF Air-Break Design AMPGARD Starter*

#### Product Description

The LF air-break design AMPGARD starter was introduced in 1962. The LF design introduced the component-to-component circuitry concept. This design greatly reduced the current-carrying connections and allowed for significant space savings.

The 25L2 and 50L2 floor-mounted NEMA 1 structures were 26 inches wide x 30 inches deep x 90 inches high. The 25L2 came in 1, 2 or 3 starters per structure. The 50L2 came in 1 or 2 starters per structure.

The 25L4 and 50L4 floor-mounted NEMA 1 starters were 36 inches wide x 30 inches deep x 90 inches high. These 400A starters could have been mounted two-high per structure.

The 25L7 and 50L7 floor-mounted NEMA 1 starters were 40 inches wide x 30 inches deep x 90 inches high. These 700A starters were mounted one per vertical structure.

#### Ratings (Maximum)

200, 400 and 700A 2500 hp at 2500V; 4500 hp at 5000V.

#### Chronology

The LF air-break design starter was introduced in 1962, first with the 2500V, 200A starter, then with the 5000V design and the 400 and 700A ratings. The starters were built in Buffalo, NY, until the operation was transferred to Asheville, NC, in 1978, where it was discontinued in the late 1980s.

#### Replacement Capabilities

##### Renewal and Replacement Parts for LF Design Starters

Refer to RPD 8855A for identifying the parts needed. Among the parts available are:

- Current and potential transformers
- Control transformers
- Fuses
- O/L relays and heaters
- Isolation switches
- Some air-break contactor parts

#### Technology Upgrades

##### Add-On Vacuum Starter Structures

New add-on vacuum structures as an extension to the LF type starter assembly may be connected directly to the main bus without a transition section.

##### 50L4 (400A) Vacuum Replacement Contactor

For replacing an existing 400A LF air contactor with the directly interchangeable 400A vacuum contactor.

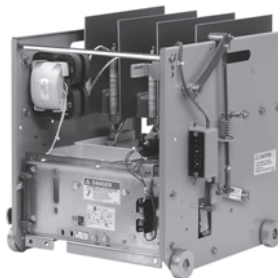

*50L4 Vacuum Replacement (Front)*



*50L4 Vacuum Replacement (Rear)*

#### 400A Air-to-Vacuum Contactor Replacement

Description	Style Number
Basic contactor 2300/120V, 750 VA transformer:	
SJ contactor	<b>2147A45G01</b>
SL contactor	<b>2147A50G01</b>
Basic contactor 2300/120V, 2 kVA transformer:	
SJ contactor	<b>2147A45G02</b>
SL contactor	<b>2147A50G02</b>
Basic contactor 4160/120V, 600 VA transformer:	
SJ contactor	<b>2147A45G03</b>
SL contactor	<b>2147A50G03</b>
Basic contactor 4160/120V, 2 kVA transformer:	
SJ contactor	<b>2147A45G04</b>
SL contactor	<b>2147A50G04</b>

**Note:** Style numbers listed above identify a basic contactor that might not include other available accessories that were specified on a customer order. Contact factory with original general order number starter drawing number and date of manufacture for assistance.

#### 400A Air-to-Vacuum Starter Cell Kit

Complete full-voltage, non-reversing, induction, vacuum AMPGARD motor starter, 400A, 7200V maximum, for mounting in existing 36-inch wide enclosure. Includes main contactor, isolation switch, three power fuses, MP-3000 motor protection without RTD module, three-phase current transformer, vertical bus, high and low voltage doors, and welded cell assembly for mounting in existing 36-inch wide enclosure.

#### 400A Air-to-Vacuum Starter Cell Kit

Description	Style Number
Slide-out with SJ	<b>2147A95G01</b>
Roll-out with SJ	<b>2147A95G02</b>
Slide-out with SL	<b>2147A95G03</b>
Roll-out with SL	<b>2147A95G04</b>

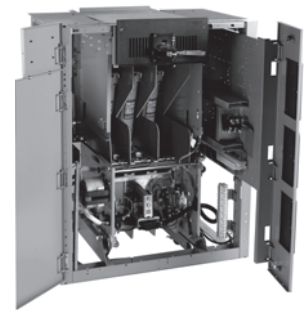

*Completely New Starter Cell*

LF Air AMPGARD Starters (Medium Voltage)



50L7 Vacuum Retrofit

**700A Air-to-Vacuum Conversion Kits**

These kits will convert an existing full-voltage non-reversing 700A air break starter to vacuum.

**700A Air-to-Vacuum Conversion Kit**

Description	Style Number
450–630A maximum	2147A95G31
720A maximum	2147A95G32

**25L2 Vacuum Replacement Contactor**

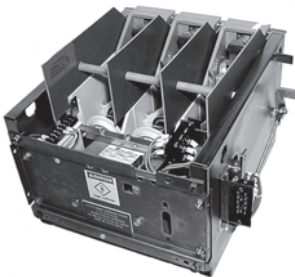

25L2 Vacuum Replacement—Front View

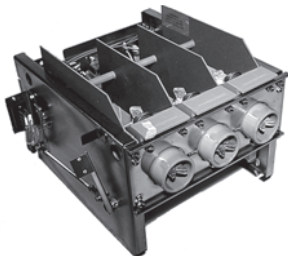

25L2 Vacuum Replacement—Rear View

This solution uses the latest technology “SL” contactor and is designed to replace vintage 25L2, 2500V, 200A, 1962 air-break contactors.

**50L2 Air-to-Vacuum Retrofit Kit**

This kit replaces the out-of-production 5000V, 200A air-break contactor with an SJ vacuum contactor, for starters built after 1974 with ISO-Switch shutter mechanism mounted in the cell. The customer keeps the existing starter cell and isolation switch and modifies the cell to accept the SJ contactor that is mechanically interlocked with the isolation switch. The rating remains 200A.

**50L2 Air-to-Vacuum Retrofit Kit**

Description	Style Number
200A maximum	2147A95G30

Ampacity upgrade to 320A design for pre-1974 50L2 retrofit kits available.

**Metering and Protective Relay Upgrades**

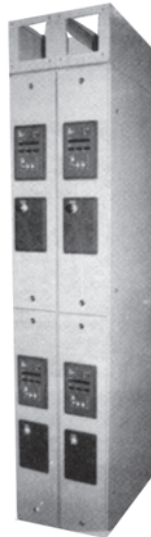

IQ Floor-Mounted Enclosure

**IQ Floor-Mounted Enclosure**

This kit is for mounting IQ family products. Includes standard AMPGARD structure construction to be used as a lineup extension. Each 90-inch high x 30-inch deep section comes with two doors, each with a works-in-a-drawer drawout panel. Each door has a maximum of three standard IQ cutouts with device panels. Supplied with or without IQ and PB devices. (Photo left shows two auxiliary sections with optional bus enclosure, IQ and PB devices.)

**IQ Floor-Mounted Upgrade**

Description	Style Number
Auxiliary section with cutouts only. 10-inch wide x 30-inch deep x 90-inch high (does not include bus enclosure, IQ or PB devices)	2147A95G35

MP-3000 and DP-4000 upgrades used for upgrading overload-relay technology from “Type-A,” IQ 2000A, IQ 2000B or IQ 1000II to the latest technology. Also upgrades with a new, slideout, LV control panel.

The kit includes:

- Typical starter schematic
- 0.50-inch deep, flange LV door with three cut-outs for new devices
- Works-in-a-drawer slide-out panel for LV control devices

**Metering and Protective Relay Upgrades**

Description	Style Number
DP-4000 and MP-3000 (without RTD)	2147A95G37
MP-3000 (without RTD) only	2147A95G39
DP-4000 only	2147A95G48
IQ 300 only	2147A95G49

**Works-in-a-Drawer Metering and Protective Relay LV Device Panel**

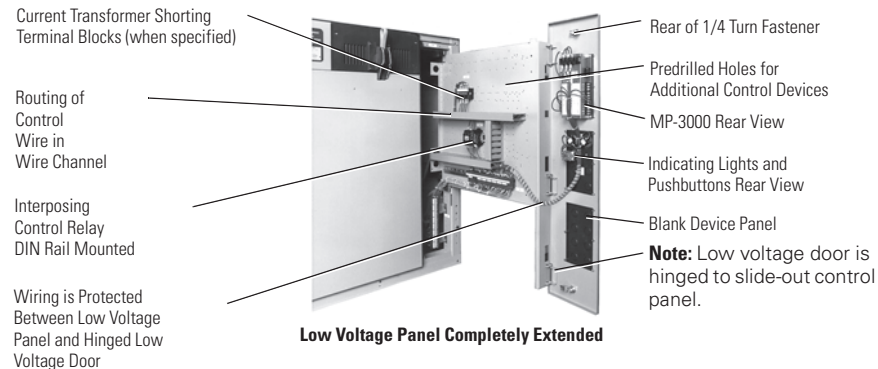

#### Classic AMPGARD

#### SL and SJ Vacuum AMPGARD

*Originally a Westinghouse Product*



*SJ Vacuum AMPGARD Assembly*

#### Product Description

The SJ vacuum contactor was designed and engineered specifically for use in AMPGARD starters. The contactor is a low-chop design that permits application matching of the starter to the motor for 2200–7200V and ratings of 400 and 800A. The 400A contactor is available in both slide-out and roll-out configurations. The 800A contactor is available in the roll-out design only. The SJ AMPGARD is a horsepower specific starter design that uses the component-to-component circuitry concept. The full-voltage 400A rating in a NEMA 1 enclosure is 36 inches wide x 30 inches deep x 90 inches high. These 400A starters are mounted one- or two-high per structure. The 800A rating in an enclosure is 40 inches wide x 30 inches deep x 90 inches high in a one-high construction for a full-voltage starter.

#### Ratings (Maximum)

400 and 800A, 3000 hp at 2500V; 5500 hp at 5000V; 8000 hp at 7200V.

#### Chronology

The SJ vacuum design AMPGARD starter was introduced in 1982 with the 400A rating. The 800A rating followed in 1987. With the introduction of the vacuum contactor, the air-break starter has been gradually phased out and is rarely specified in an assembly. The starters are built in Asheville, NC.

AMPGARD assemblies were made available with the new SL Contactor in late 1999. Except for the 400A frame contactor, SJ and SL AMPGARD assemblies are virtually identical.

#### Replacement Capabilities

##### Renewal and Replacement Parts for SJ Design Starters

Refer to RP.48J.01.T.E for identifying the parts needed.

##### Common Replacement Parts for SL Design Starters

Refer to RP02003002E for identifying the parts needed.

##### Add-On Vacuum Starter Structures

New add-on vacuum structures as an extension to the SJ type structure may be connected directly to the main bus without a transition section. Contact your local Eaton Field Sales office.

##### Replacement Vacuum Contactors

New replacement vacuum break contactors are available for all SJ model ratings.

#### 400A Vacuum Roll-out Replacement Contactor

Description	Style Number
Basic contactor 2300/120V, 750 VA transformer:	
SJ contactor	<b>2147A45G01</b>
SL contactor	<b>2147A50G01</b>
Basic contactor 2300/120V, 2 kVA transformer:	
SJ contactor	<b>2147A45G02</b>
SL contactor	<b>2147A50G02</b>
Basic contactor 4160/120V, 750 VA transformer:	
SJ contactor	<b>2147A45G03</b>
SL contactor	<b>2147A50G03</b>
Basic contactor 4160/120V, 2 kVA transformer:	
SJ contactor	<b>2147A45G04</b>
SL contactor	<b>2147A50G04</b>

**Note:** Style numbers listed above identify a basic contactor that might not include other available accessories that were specified on a customer order. Contact factory with original general order number, starter drawing number, and date of manufacture for assistance.

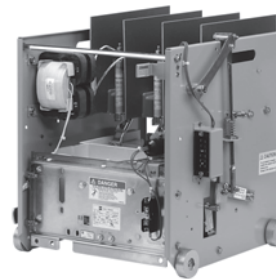

*400A SL Roll-Out Replacement (Front)*



*400A SL Slide-Out Replacement (Front)*



*400A SL Roll-Out Replacement (Rear)*

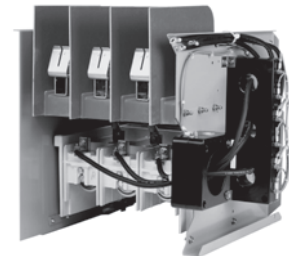

*400A SL Slide-Out Replacement (Rear)*

SL and SJ Vacuum AMPGARD Starters (Medium Voltage)

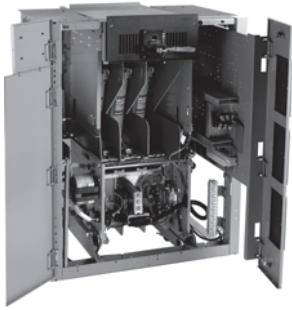

Completely New Starter Cell

400A Vacuum Starter Cell Kit

The 400A vacuum starter cell kit is used to fill a blank cell in an SL or SJ AMPGARD assembly or to completely replace an existing 400A SL or SJ starter.

It is a complete full-voltage, non-reversing, induction, vacuum AMPGARD motor starter, 400A, 7200V maximum, for mounting in existing 36-inch wide enclosure. It includes main contactor, isolation switch three power fuses, MP-3000 motor protection without RTD module, three-phase current transformer, vertical bus, high and low voltage doors, and welded cell assembly for mounting in existing 36-inch wide customer enclosure.

400A Vacuum Starter Retrofit Kit

Description	Style Number
Slide-out with SJ	2147A95G01
Roll-out with SJ	2147A95G02
Slide-out with SL	2147A95G03
Roll-out with SL	2147A95G04

Technology Upgrades

MP-3000 and DP-4000 upgrades used for upgrading overload-relay technology from "Type-A," IQ 2000A, IQ 2000B or IQ 1000II to the latest technology. Also upgrades with a new, slideout, LV control panel.

The kit includes:

- Typical starter schematic
- 0.50-inch deep, flange LV door with three cut-outs for new devices
- Works-in-a-drawer slide-out panel for LV control devices

Metering and Protective Relay Upgrades

Description	Style Number
DP-4000 and MP-3000 (without RTD)	2147A95G37
MP-3000 (without RTD) only	2147A95G39
DP-4000 only	2147A95G48
IQ Data only	2147A95G49

Works-in-a-Drawer Metering and Protective Relay LV Device Panel

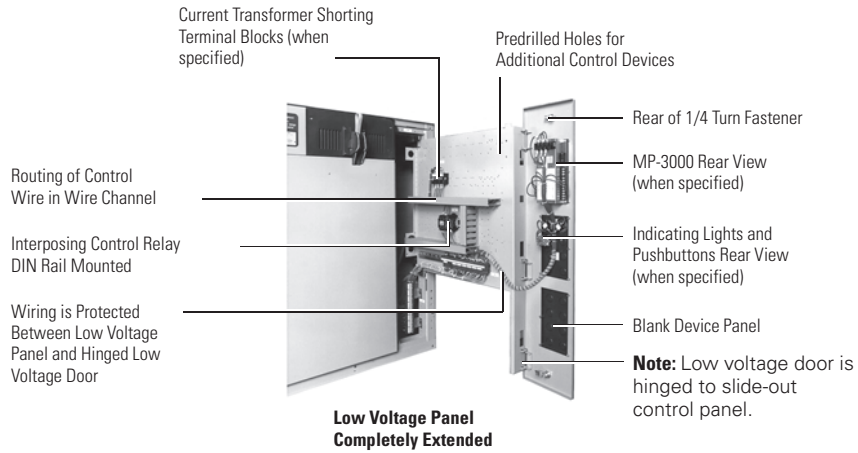

## Next Generation AMPGARD

### SLB and SLS Contactors AMPGARD



*Next Generation AMPGARD Lineup—  
Front View*

#### Product Description

Medium voltage control reaches a higher level of design with the next generation of Cutler-Hammer AMPGARD starters from Eaton. This product incorporates 60 years of experience with over 75,000 units installed worldwide. The SLB and SLS contactor is a low-chop design that controls 200–8000 hp motors with ratings of 400 and 800A vacuum contactors. The contactor is available in a stab (SLS) or bolted (SLB) design within the starter cell. The two-high structure design can accommodate two 400A or one 800A contactor/starter designs. The two-high structure is 36 W x 92 H x 30 D inches (914.4 x 2336.8 x 762.0 mm), which includes a 12-inch high top-mounted main bus compartment.

#### Ratings (Maximum)

400 and 800A 3000 hp at 2500V; 5500 hp at 5000V; 8000 hp at 7200V.

#### Chronology

The SLB and SLS vacuum design AMPGARD starter was introduced in 2005 with both 400 and 800A ratings to be incorporated into the next generation of AMPGARD assembly. The starters are built in Asheville, NC. The new SLS and SLB contactors will not be interchangeable with the existing SJ or SL contactors.

#### Replacement Capabilities

For further information, contact the Asheville plant at **1-800-523-3775**.

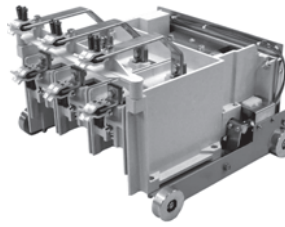

*Stab-In AMPGARD 400A  
Contactor—Rear View*

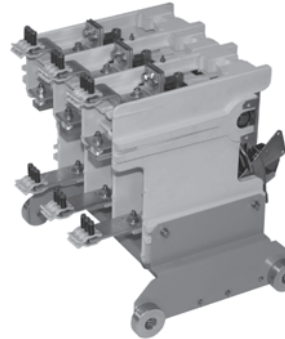

*Stab-In AMPGARD 800A  
Contactor—Rear View*



SL and SJ Vacuum AMPGARD Starters (Medium Voltage)

**AMPGARD IT. Soft Start Components**

The Cutler-Hammer AMPGARD **IT.** Soft Start components are now available for upgrading existing full-voltage and reduced-voltage starters. The requirements to convert starters into AMPGARD **IT.** Soft Start will depend on specific configurations of the existing starter. Space will be required for two 36-inch wide, 45-inch high cells that are ideally mounted in the same vertical structure. The upper compartment contains the 'M' Contactor Cell and the lower compartment contains the SCR Truck Cell. The new door provided with the SCR Truck Cell includes the MV801 control module and is made to interlock with the door on the upper compartment.

If the targeted upgrade is for a FVNR AMPGARD starter presently located in the upper compartment, then the conversion is simplified by using the existing FVNR starter as the 'M' contactor cell and converting the bottom compartment into the SCR truck cell. The 'M' contactor load terminals are connected to the SCR truck cell terminals using three copper bus connectors. Available SCR truck ratings include 200A and 400A. See **Page V12-T13-98** for a description of other existing starter configurations. The advanced diagnostics included in the MV801 control module include:

- Phase loss
- Phase imbalance
- Jam
- Stall
- Over/undervoltage
- Motor overload



**MV801 Control Module**



**AMPGARD IT. Soft Start (Doors Open)**



**AMPGARD IT. Soft Start**



**SCR Truck (Rear)**



**SCR Truck Cell**

#### Typical AMPGARD Starter Configurations

**Example 1  
(Before Retrofit)**

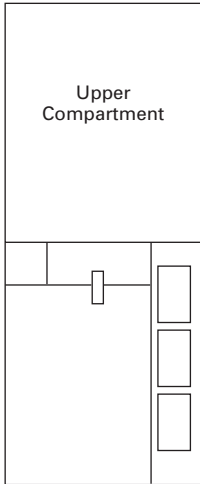

**Note:** Example 1—Upper Compartment must be converted to 'M' contactor cell. Lower compartment must be converted into SCR truck cell.

**Example 2  
(Before Retrofit)**

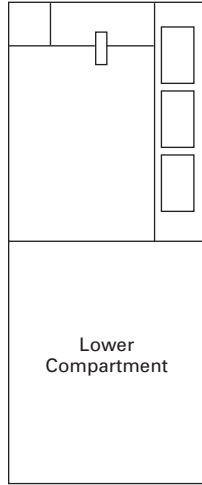

**Note:** Example 2—Upper compartment FVNR can be used as the 'M' contactor cell. Lower compartment must be converted to SCR truck cell.

**Example 1 and 2  
(After Retrofit)**

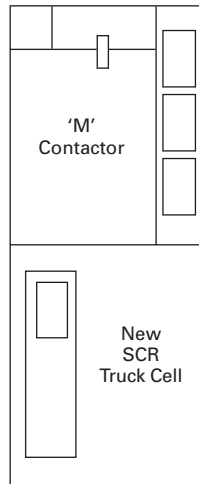

**Example 3 (Before Retrofit)**

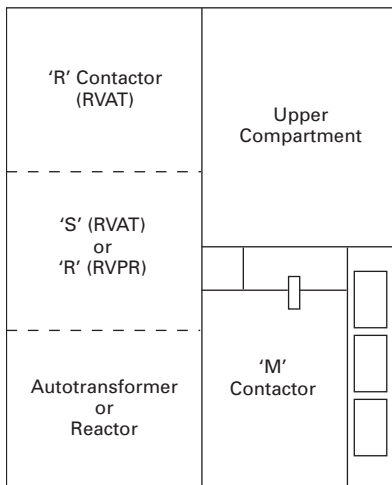

**Note:** Example 3—'M' contactor cell can be relocated to upper compartment. Lower compartment must be converted into SCR truck cell.

**Example 3 (After Retrofit)**

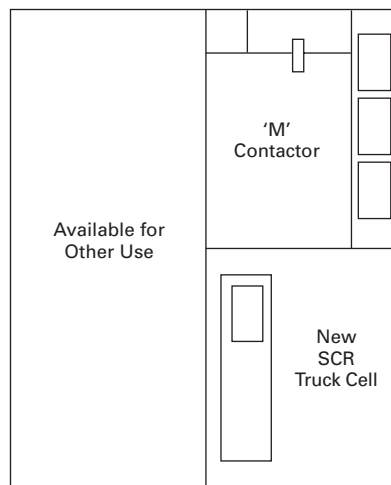

**AMPGARD Solutions Overview**

**AMPGARD Selection Table**

Installed Equipment	Vintage	AMPGARD Aftermarket Products Available					Vacuum Replacements	Class 1 Reconditioning	Reference Material
		Add-on Structure ①	Cell ②	Isolation Switch ③	Contactor ④	Parts ⑤			
AMPGARD OIL	1945–1957						■		—
AMPGARD AH	1948–1957						■		—
AMPGARD AMI	1948–1957						■		—
AMPGARD 25L2	1962–1990	■				■ ⑥	■	■	RPD8855A
AMPGARD 50L2	1963–1981	■				■ ⑥	■	■	RPD8855A
AMPGARD 50V4	1972–1979	■	■	■			■	■	RP48J01TE
AMPGARD 25/50L4	1966–1989	■	■	■		■ ⑥	■	■	RPD8855A
AMPGARD 25/50L7	1969–1989	■		■		■ ⑥	■	■	RPD8855A
AMPGARD V202 (SJ) 400A	1982–2000	■	■	■	■	■	■	■	RP48J01TE
AMPGARD S202 (SJ) 400A	1987–2000	■	■	■	■	■	■	■	RP48J01TE
AMPGARD W210 (SL) 400A	2000–	■	■	■	■	■	■	■	RP02003002E
AMPGARD F210 (SL) 400A	2000–	■	■	■	■	■	■	■	RP02003002E
AMPGARD V202 (SJ) 800A	1985–	■		■	■	■	■	■	RP48J01TE
Synchronous Control	1950–	■	■			■			RP04304009E

**Notes**

- ① Add-on structures contain vacuum starters only.
- ② Complete cell including frame, ISO-switch, vacuum or air contactor, and all components to complete a starter.
- ③ Isolation switch only (LFR replaced LFM after 1974).
- ④ Complete contactor, available in SJ or SL.
- ⑤ New, genuine parts per original specs.  
 Vacuum replacements— OIL, AH, AMI (one-high starters) Complete Cell Retrofit  
 25L2 Vacuum Replacement Contactor  
 50L2 Vacuum Retrofit Kit  
 50V4 Vacuum Replacement Contactor  
 25/50L4 Vacuum Replacement Contactor  
 Synchronous Mark V Solid-State Control Retrofit  
 25/50L7 Vacuum Replacement Contactor and Some Cell Modification
- ⑥ Check with factory.

**Further Information**

Publication Number	Description
RPD8855A	Renewal Parts Data for AMPGARD LF Air-Break Vintage 200–700A
RPD8855S	Renewal Parts Data for AMPGARD Slipsyn Synchronous Control
RP48J01TE	Renewal Parts for AMPGARD SJ Vacuum-Break Vintage 400–800A
RP02003002E	Common Renewal Parts for AMPGARD SL 400A Vacuum Contactors
TD48A01ATE	Technical Data for AMPGARD MV Starters
PG48C01TE	Product Guide “SL” Medium Voltage Vacuum Contactors
IB48008	Instructions for AMPGARD Mark V Solid-State, Brush-Type, Synchronous Motor Controllers
IB48009	Instructions for AMPGARD Synchronous Motor Field Regulator with VAR and PF Control

**Pricing Information**

Price and Availability Digest (PAD)