

600H and 600NH series

Toggle switches - high amperage

Distinctive features and specifications



Construction

Terminal and contact support are manufactured from a single piece of metal. The contacts are resistance-welded to the terminal for increased mechanical strength.

Rating

These switches are suitable for motor loads and power applications up to 15A 250VAC or 10A 400VAC

Metal or insulated lever

UL, CSA and NF-VDE (EN 61058-1) approved

ELECTRICAL SPECIFICATIONS

- Max. current/voltage ratings : see tables below
- Peak current : 30A max. during 1/2 sine, 250VAC
- Initial contact resistance : 10 mΩ max. at 1A 2VDC
- Insulation resistance : 1.000 MΩ min. at 500VDC
- Dielectric strength :
2.000 Vrms 50 Hz min. between terminals
2.500 Vrms 50 Hz min. between terminals and frame
- Electrical life : 10.000 cycles at full load

Models for peak currents

Models 600SH and 600SNH with silver cadmium oxide contacts are **discontinued**. They will be replaced by switches with silver tin oxide contacts.

APPROVED RATINGS

MODELS	FUNCTIONS	600H - 600NH		
		UL	CSA	NF-VDE
		UL 1054	CSA 22-2	EN 61058-1
Single and double pole	ON - OFF (1)	15A 1/2 HP 125-250VAC		10(4)A 400VAC T 85/55 (600H)
	ON - ON (6)			
	Other (4-7-8-9)	10A 1/2 HP 125-250VAC		
Three pole	ON - OFF (1) & ON - ON (6)	15A 1/2 HP 125-250VAC		T 125/55 (600NH)
	Other (4-7-8-9)	10A 1/2 HP 125-250VAC		

- FOR INFORMATION-

Max. current/voltage rating w. resistive load

Functions	Ratings	Electrical life
ON - OFF ON - ON	15A 250VAC 10A 24VDC 15A 12VDC	10.000 cycles
ON OFF ON	15A 250VAC	6.000 cycles
Other	15A 125VAC 12A 250VAC 5A 25VDC	10.000 cycles

MATERIALS

- Case : polyester UL94-V0
- Actuator :
- 600H : brass, nickel plated
- 600NH : black polyamide
- Bushing : brass, nickel plated
- Contacts : silver/nickel alloy

GENERAL SPECIFICATIONS

- Torque : 1,50 Nm (1.10 Ft.lb) max. applied to nut
- Panel thickness : 4,5 mm (.177) max. between 2 nuts
- Operating temperature : -20°C to +55°C

600H and 600NH series

Toggle switches - high amperage

Specifications

AGENCY APPROVALS



Availability : see chart on previous page.

Marking : approved models are standard marked.

PANEL CUT-OUT

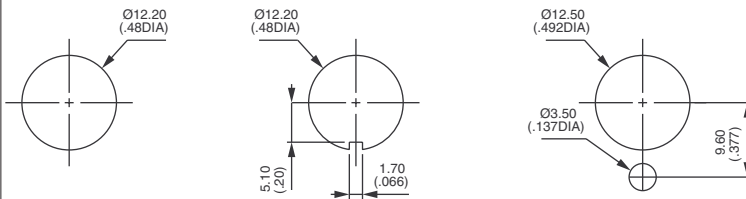

MOUNTING RECOMMENDATIONS

Connection

- For quick-connect terminals, use 6,3 x 0,8 mm normalized female connectors.
- For screw terminals, use :
either 1,5 mm² or 2,5 mm² rigid wires,
or prepared stripped and tin plated flexible wires,
or prepared flexible wires with crimped termination per EN 50027 (DIN 46228)

Ground connector

Compulsory if the panel is not metallic or not connected to ground. Should also be used when front face nut is of plastic material.

Order separately, see section I.

600H and 600NH series

Toggle switches - high amperage

Overview

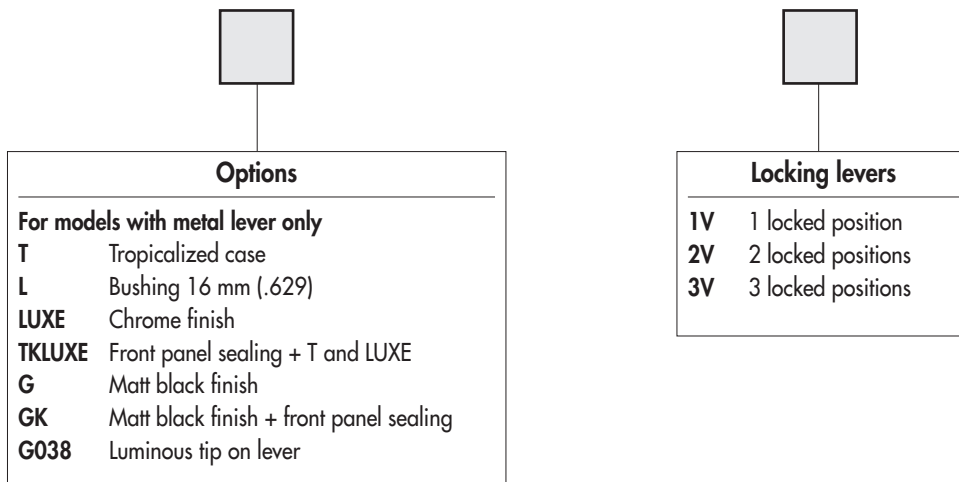
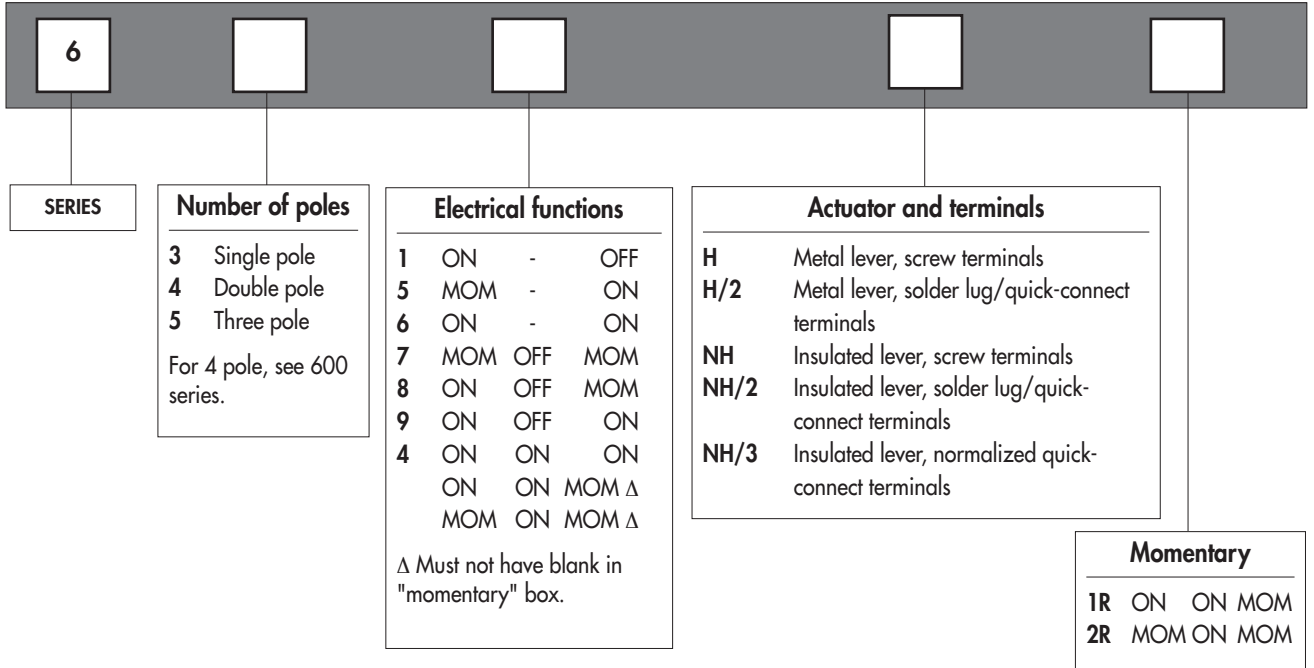

ABOUT THIS SERIES

Dimensions : first dimensions are in mm while inches are shown as bracketted numbers.



NOTICE : please note that not all combinations of above numbers are available. Refer to the following pages for further information.

Security caps are available to prevent inadvertent lever operation. They are presented in section I.



Sealing boots are available on 600H series to protect the switches against dust and water. They are presented in section H.



Mounting accessories : standard hardware supplied with all models :

- 600H and series : 1 hex nut U166 and 1 knurled nut U411
 - 600NH series : 1 hex nut U166 and 1 knurled nut U522
- Standard and special hardware are presented in section I.



Packaging unit : 25 pieces.



600H series

Toggle switches - high amperage - metal lever

Solder lug/quick-connect terminals - screw terminals

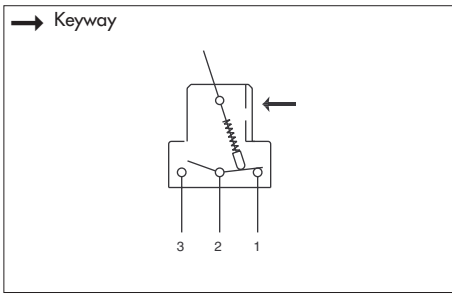

- 2 and 3 maintained or momentary positions
- Solder lug/quick-connect terminals 6,35 x 0,8 (.250 x .031) or screw terminals + clamp
- 1, 2 and 3 pole configurations
- Normalized quick-connect terminals (/3) optional. On request.

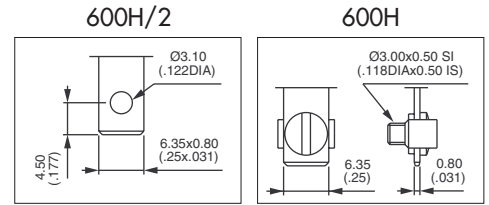

MODEL STRUCTURE



Single pole



Solder lug	Screw term.
631H/2	631H
635H/2	635H
636H/2	636H
637H/2	637H
638H/2	638H
639H/2	639H

III	II	I
2-1		2-3
ON	-	OFF
MOM	-	ON
ON	-	ON
MOM	OFF	MOM
ON	OFF	MOM
ON	OFF	ON

→ Keyway

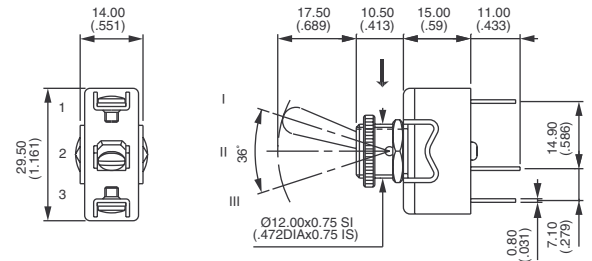

Double pole



Solder lug	Screw term.
641H/2	641H
644H/2	644H*
644H/2-1R	644H-1R*
644H/2-2R	644H-2R*
645H/2	645H
646H/2	646H
647H/2	647H
648H/2	648H
649H/2	649H

III	II	I
2-1		2-3
5-4		5-6
ON	-	OFF
ON	ON	ON
ON	ON	MOM
MOM	ON	MOM
MOM	-	ON
ON	-	ON
MOM	OFF	MOM
ON	OFF	MOM
ON	OFF	ON

→ Keyway

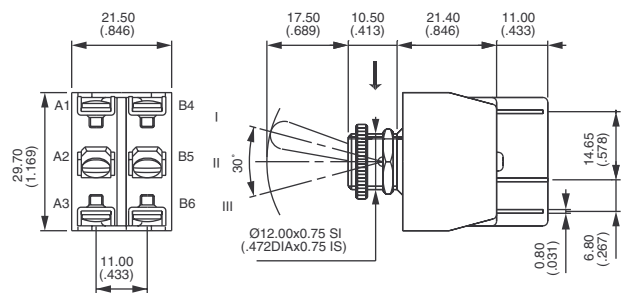

* Function 4 : SP in DP case - see end of catalogue.

Three pole



Solder lug	Screw term.
651H/2	651H
655H/2	655H
656H/2	656H
657H/2	657H
658H/2	658H
659H/2	659H

III	II	I
2-1		2-3
5-4		5-6
8-7		8-9
ON	-	OFF
MOM	-	ON
ON	-	ON
MOM	OFF	MOM
ON	OFF	MOM
ON	OFF	ON

→ Keyway

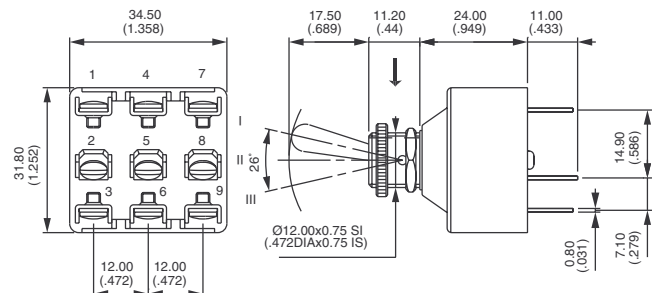

600H series

Toggle switches - high amperage - metal lever

OPTIONS



OPTIONS FOR 600H SERIES ONLY

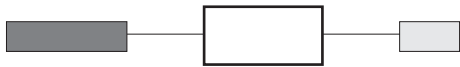

Complete above box with desired options in the same order as below

- T** Tropicalized diallylphthalate case (-40°C to +85°C)
- K** Front panel sealing by 1 O-ring and sealing washer. Protects the switch against water and dust. Panel seal withstands 1 bar pressure and remains sealed even when switch is operated
- L** Special threaded bushing, length 16 mm (.629)
- LUXE** Chrome plated lever and cap nut U117
- TK LUXE** Options T, K and LUXE.
- G** Matt black finish on bushing, lever and nuts. Includes tropicalization (option T)
- GK** Front panel sealing by O-ring and sealing washer (as described in option TK LUXE) + option G
- G038** Option G + fluorescent tip on lever. White fluorescent tip becomes luminous when submitted to ultra violet rays.

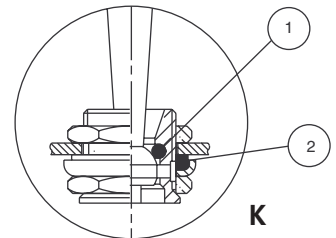

① O-ring ② Sealing washer

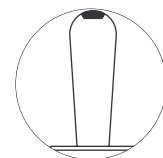

0.38

LOCKING LEVERS (1 and 2 pole models)

For 3-pole models, refer to 6000 series.

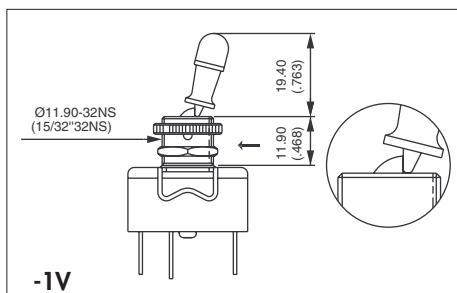
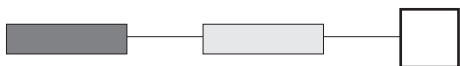

-1V

1 locked position

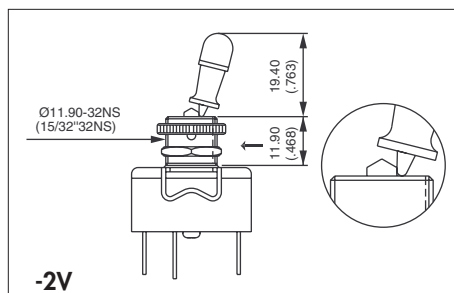

-2V

2 locked positions

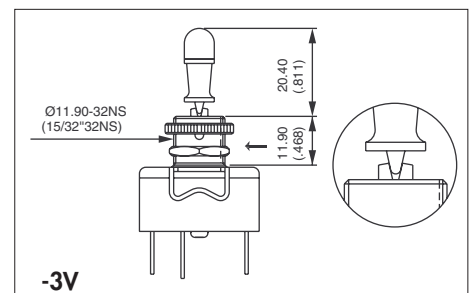

-3V

3 locked positions

→ Keyway

ACTUATOR OPTIONS (1 and 2 pole models)

- 30 mm (1.181) long actuator
- 40 mm (1.574) long actuator
- Retro style actuator, gold plated or chrome plated
On request
- Ergonomic flat plastic actuator : add U282 at the end of switch model number.

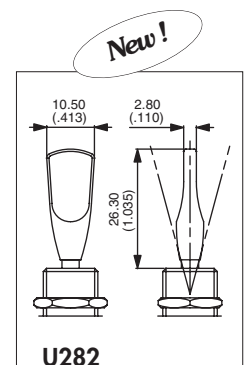
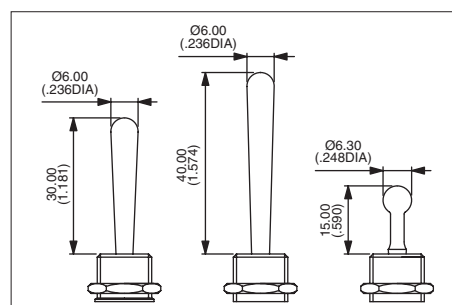

U282

New!



6-600H series

Toggle switches - metal lever

SPECIFICATIONS

- Max. current/voltage rating with resistive load : 6A 250VAC and 125VAC
- Initial contact resistance : 10mΩ max. at 1A 2VDC
- Insulation resistance : 1.000 MΩ min. at 500VDC
- Dielectric strength : 2.500 Vrms 50 Hz min. between terminals
2.500 Vrms 50 Hz between terminals and frame
- Electrical life at full load : 10.000 cycles
- Torque : 1,50 Nm (1.10 Ft.lb) max. applied to nut
- Panel thickness : 4,5 mm (.177) max. between 2 nuts
- Operating temperature : -20°C to +55°C
- Hardware supplied : 1 hex nut U166 and 1 knurled nut U411

MATERIALS

- Case : melamine/polyester
- Actuator : brass, nickel plated
- Bushing : brass, nickel plated
- Contacts : copper, silver plated

6-600H/2

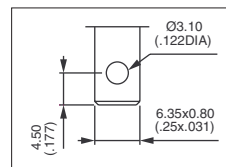

6-600H

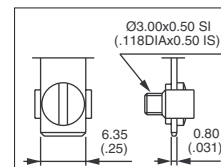

Single pole

→ Keyway



Solder lug	Screw term.
6-631H/2	6-631H
6-636H/2	6-636H
6-639H/2	6-639H

III	II	I
2-1		2-3
ON	-	OFF
ON	-	ON
ON	OFF	ON

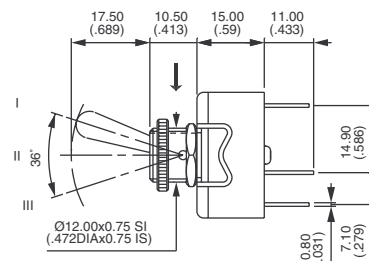
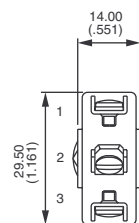

Double pole

→ Keyway



Solder lug	Screw term.
6-641H/2	6-641H
6-646H/2	6-646H
6-649H/2	6-649H

III	II	I
2-1		2-3
5-4		5-6
ON	-	OFF
ON	-	ON
ON	OFF	ON

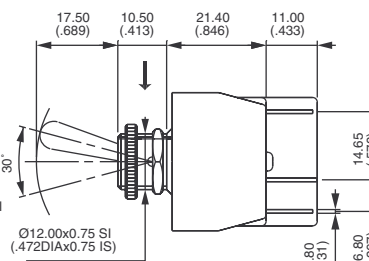
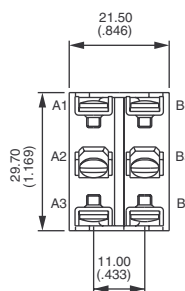

Three pole

→ Keyway



Solder lug	Screw term.
6-651H/2	6-651H
6-656H/2	6-656H
6-659H/2	6-659H

III	II	I
2-1		2-3
5-4		5-6
8-7		8-9
ON	-	OFF
ON	-	ON
ON	OFF	ON

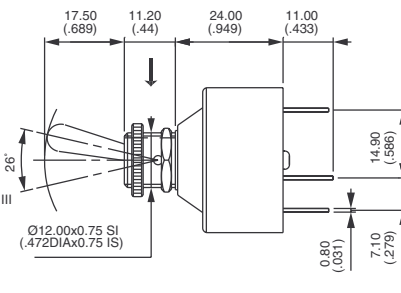
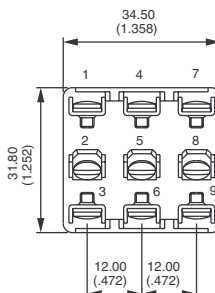

600NH series

Toggle switches - high amperage - insulated lever

Solder lug/quick-connect terminals - screw terminals

MODEL
STRUCTURE

→ Keyway

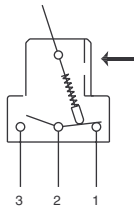

- 2 and 3 maintained or momentary positions
- Solder lug/quick-connect terminals 6,35 x 0,8 (.250 x .031) or screw terminals + clamp
- 1, 2 and 3 pole configurations
- Normalized quick-connect terminals (/3) optional. On request.

600NH/2

600NH

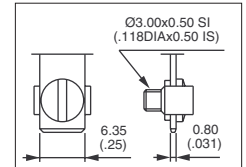
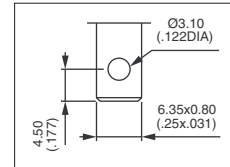

Single pole



Solder lug Screw term.

	III	II	I
631NH/2	2-1		2-3
635NH/2			
636NH/2			
637NH/2			
638NH/2			
639NH/2			

	III	II	I
	ON	-	OFF
	MOM	-	ON
	ON	-	ON
	MOM	OFF	MOM
	ON	OFF	MOM
	ON	OFF	ON

→ Keyway

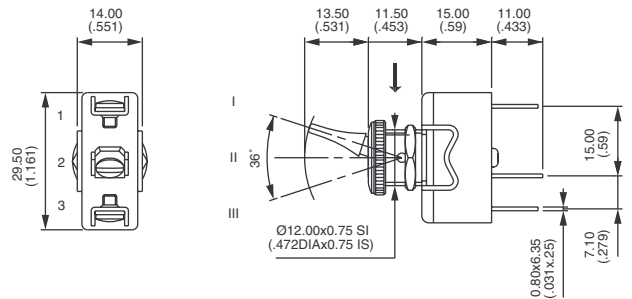

Double pole



Solder lug Screw term.

	III	II	I
641NH/2	2-1		2-3
644NH/2			
644NH/2-1R	5-4		5-6
644NH/2-2R			
645NH/2			
646NH/2			
647NH/2			
648NH/2			
649NH/2			

	III	II	I
	ON	-	OFF
	ON	ON	ON
	ON	ON	MOM
	MOM	ON	MOM
	MOM	-	ON
	ON	-	ON
	MOM	OFF	MOM
	ON	OFF	MOM
	ON	OFF	ON

→ Keyway

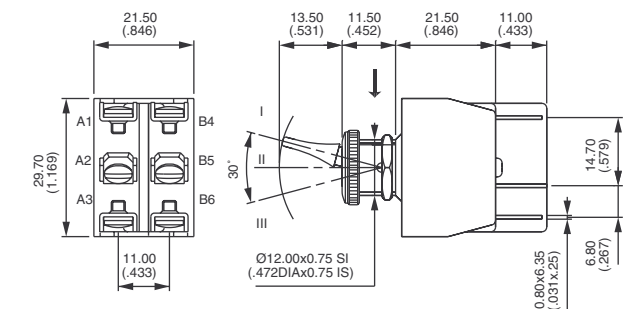

* Function 4 : SP in DP case - see end of catalogue.

Three pole



Solder lug Screw term.

	III	II	I
651NH/2	2-1		2-3
655NH/2			
656NH/2			
657NH/2			
658NH/2			
659NH/2			

	III	II	I
	ON	-	OFF
	MOM	-	ON
	ON	-	ON
	MOM	OFF	MOM
	ON	OFF	MOM
	ON	OFF	ON

→ Keyway

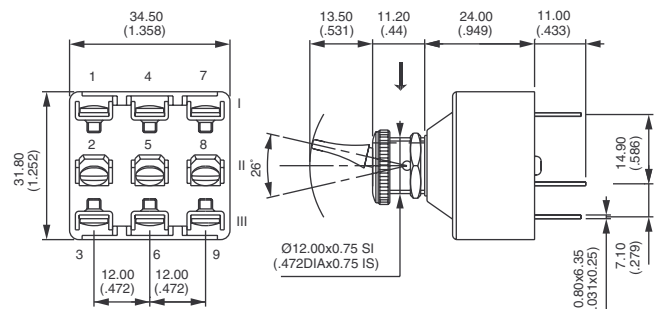



6-600NH series

Toggle switches - insulated lever

SPECIFICATIONS

- Max. current/voltage rating with resistive load : 6A 250VAC and 125VAC
- Initial contact resistance : 10mΩ max. at 1A 2VDC
- Insulation resistance : 1.000 MΩ min. at 500VDC
- Dielectric strength : 2.500 Vrms 50 Hz min. between terminals
2.500 Vrms 50 Hz between terminals and frame
- Electrical life at full load : 10.000 cycles
- Torque : 1,50 Nm (1.10 Ft.lb) max. applied to nut
- Panel thickness : 4,5 mm (.177) max. between 2 nuts
- Operating temperature : -20°C to +55°C
- Hardware supplied : 1 hex nut U166 and 1 knurled nut U522

MATERIALS

- Case : melamine/polyester
- Actuator : black polyamide
- Bushing : brass, nickel plated
- Contacts : copper, silver plated

6-600NH/2

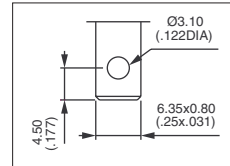

6-600NH

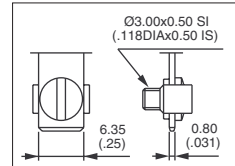

Single pole



	Solder lug	Screw term.
6-631NH/2	6-631NH	6-631NH
6-636NH/2	6-636NH	6-636NH
6-639NH/2	6-639NH	6-639NH

III	II	I
2-1		2-3
ON	-	OFF
ON	-	ON
ON	OFF	ON

→ Keyway

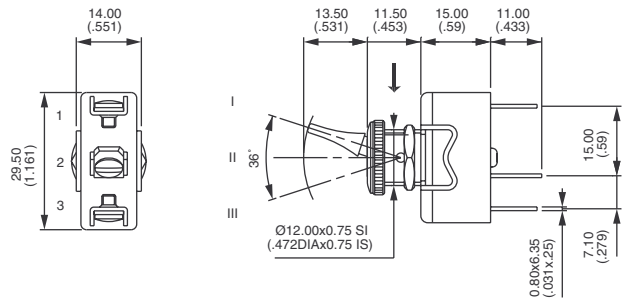

Double pole



	Solder lug	Screw term.
6-641NH/2	6-641NH	6-641NH
6-646NH/2	6-646NH	6-646NH
6-649NH/2	6-649NH	6-649NH

III	II	I
2-1		2-3
5-4		5-6
ON	-	OFF
ON	-	ON
ON	OFF	ON

→ Keyway

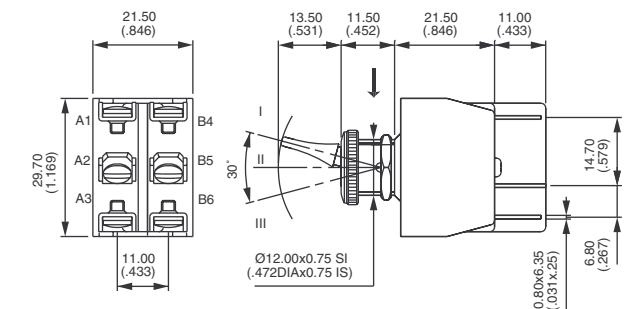

Three pole



	Solder lug	Screw term.
6-651NH/2	6-651NH	6-651NH
6-656NH/2	6-656NH	6-656NH
6-659NH/2	6-659NH	6-659NH

III	II	I
2-1		2-3
5-4		5-6
8-7		8-9
ON	-	OFF
ON	-	ON
ON	OFF	ON

→ Keyway

