

Amphenol 62GB Series



MIL-DTL-26482 PERFORMANCE WITHOUT MIS-MATING

Amphenol's 62GB series connectors are similar to MIL-DTL-26482 but with the advantage of keyway orientation to reduce mis-mating among multiple connectors. They feature aluminum shells with brass or stainless steel options available. PEI-Genesis is the largest assembler of 62GB connectors in the world.

- Meets British Standard Specification BS 9522 F00 17 & Pattern 105

APPLICATIONS

Industrial, commercial and medical applications where mis-mating or cross-plugging are a concern.

- Aircraft
- Communications systems
- Factory automation
- Industrial machinery
- Medical instrumentation
- Mobile equipment
- Sensors
- Ships

FEATURES

RUGGED SHELL

Machined aluminum alloy shell and hardware create an exceptionally strong connector. These connectors have been used extensively in commercial, military, and aerospace environments. Standard shells accept most MIL-DTL-26482 accessories.

ENVIRONMENTALLY-SEALED

Complete moisture sealing is achieved by combining four seals: shell, peripheral, interfacial, and wire. Wire seal is accomplished by multiple ripple design, exceeding the wire sealing requirements of MIL-DTL-26482.

RESISTANT TO HARSHTEST ENVIRONMENTS

These connectors will operate in temperatures from -67°F to +257°F (-55°C to +125°C) under the harshest possible conditions.

WIDE RANGE OF WIRE GAUGES AND CURRENT-CARRYING CAPABILITY

Up to 45 amps with wire gauges from size 24 to 8 AWG wire.

RESILIENT INSULATOR & GROMMET

A resilient neoprene insulator and integrated rear-wire sealing grommet guarantees a liquid-tight assembly. Solder contacts are permanently bonded into the insulator.

SOLDER GOLD-PLATED CONTACTS

62GB connector contacts are gold-plated. Socket contacts are closed to eliminate damage from test probes and to help prevent misaligned pins during engagement.

AGENCY APPROVALS

- Based on MIL-DTL-26482

TECHNICAL SPECIFICATIONS

MATERIALS & FINISHES

Shell	Aluminum alloy
Plating	Standard-green zinc; electroless nickel; black-anodized; clear chromate over cadmium; olive drab chromate over cadmium; black zinc cobalt; black zinc-nickel; unplated stainless steel; unplated brass
Contacts	Copper alloy
Platings	Gold plate, 50 microinches minimum per MIL-G-45204 type II
Insulator	Polychloroprene rubber compound

ELECTRICAL DATA

Operating Voltage & Test Voltage per BS9500 F0017, clause 7.1.2

SERVICE RATING	TEST ALTITUDE	NOMINAL WORKING VOLTAGE PEAK DC OR AC	VOLTAGE PROOF DC OR AC - DWV
I	Sea Level	700	2100
II		1200	3000
III		1500	3000
I	70,000 Feet	330	660
II		380	760
III		450	750

Each insulator layout has a specific "service rating." The service ratings for each layout are listed on [pages 151 & 152](#).

Current Rating

CONTACT SIZE	TEST CURRENT AMPS (WORKING)	POTENTIAL DROP (MILLIVOLTS) INITIAL	CONTACT RESISTANCE MILLIOHMS (MAX)
20	7.5	< 55	10
16	13	< 50	10
12	23	< 50	10
8	40	< 50	10

Wire Range Sizes 24 to 8 AWG

Contact Resistance When tested to MIL-STD-1344 Method 3004, will not exceed voltage drops listed in table above. Consult MIL-DTL-26482, 3.6.4 for details.

Insulation Resistance 5,000 megohms minimum at 77°F (25°C)

MECHANICAL

Operating Temperature -67°F to +257°F (-55°C to +125°C)

Sealing 48 hours in six feet of water per MIL-DTL-26482 4.6.14. Meets 10- and 20-day 50-95% humidity testing per MIL-STD-1344 Method 1002.2 per MIL-DTL-26482.

Wire Sealing Range

CONTACT SIZE	AWG WIRE SIZE	INSULATION O.D. LIMITS: INCHES (MM)	
		MIN.	MAX.
20	24, 22, 20	.060 (1.52)	.085 (2.16)
16	20, 18, 16	.066 (1.68)	.109 (2.77)
12	12, 14	.097 (2.46)	.142 (3.78)
8	8	.135 (3.43)	.145 (3.68)

Insulation Strip Lengths

CONTACT SIZE	WIRE SIZE (AWG)	STRIP LENGTH INCHES (mm)
20	20-24	.275 (7.0)
16	16-20	.250 (6.4)
12	12-14	.250 (6.4)
8	8-10	.232 (5.9)

Mating Life	500 cycles minimum
Salt Spray	48 hours in mated conditions. The salt spray endurance of 62GB connectors with specific plating deviations could potentially be extended (for example, cadmium plating can withstand 500h, exposure to salt spray, black zinc-nickel plating 200h and stainless steel as much as 2000h), but without testing, the plating on a 62GB connector performance cannot be guaranteed.
Heat	+347°F (+175°C) for 1000 hours to MIL-STD-1344 Method 1005.1 per MIL-DTL-26482.
Chemical Resistance	Immersion in solvents and fluids including aircraft fuels, lubricating oils and hydraulic fluids.
Vibration	10 to 2,000Hz (15g's) 10 microseconds maximum discontinuity. To MIL-STD-1344 Method 2005 per MIL-DTL-26482.
Shock	50g's. 11ms duration, three major axes. 10 microseconds maximum discontinuity. To MIL-STD-1344 Method 2004 per MIL-DTL-26482.
Contact Type	Solder, crimp, PC
Number of Circuits	2 - 61
Contact Retention	To MIL-STD-1344 Method 2007 per MIL-DTL-26482

CONTACT SIZE	AXIAL LOAD MIN. NEWTONS (LBS)
20	66.7 (15)
16	112 (25)
12	112 (25)
8	178 (40)

Polarization	Five-keyway, three-point bayonet with optional rotational polarization and keyway positions. → See pages 151 & 153.
--------------	---



NEED HELP? PEI engineers will help you find the most cost-effective connector for your application. Email us at techsupport@peigenesis.com or fill out our online technical request at www.peigenesis.com/technical-support. To contact us by phone, please see the back cover for a complete listing of our branch offices and contact numbers.

CREATE YOUR SOLDER PART NUMBER USING THESE SIX STEPS

1*	2	3	4	5
62GB-56TG	10-06	P	W	-416
SHELL STYLE	LAYOUT	CONTACT	ROTATION OR KEYWAY	MODIFIER

*62GB - for Standard Green Zinc (RoHS) 62GBSS - for Stainless Steel 62GBCU - for Brass 62ZN - for Black Zinc-Nickel

STEP 1: SELECT SHELL STYLE, PLUG, RECEPTACLE & REAR ACCESSORY

PLUGS

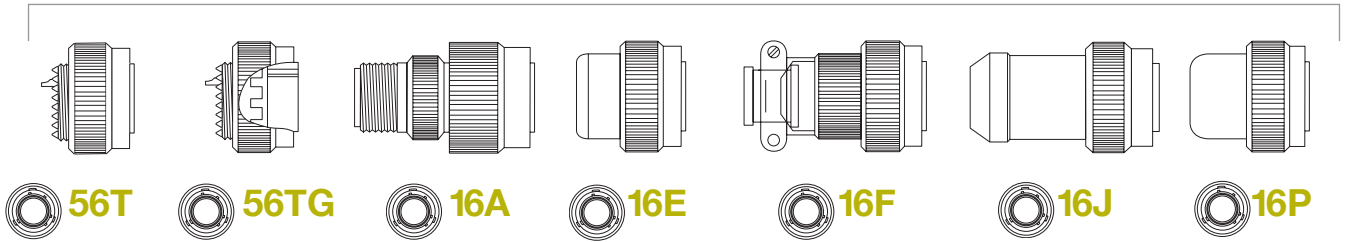

Mates with

INLINE RECEPTACLES

FLANGE RECEPTACLES

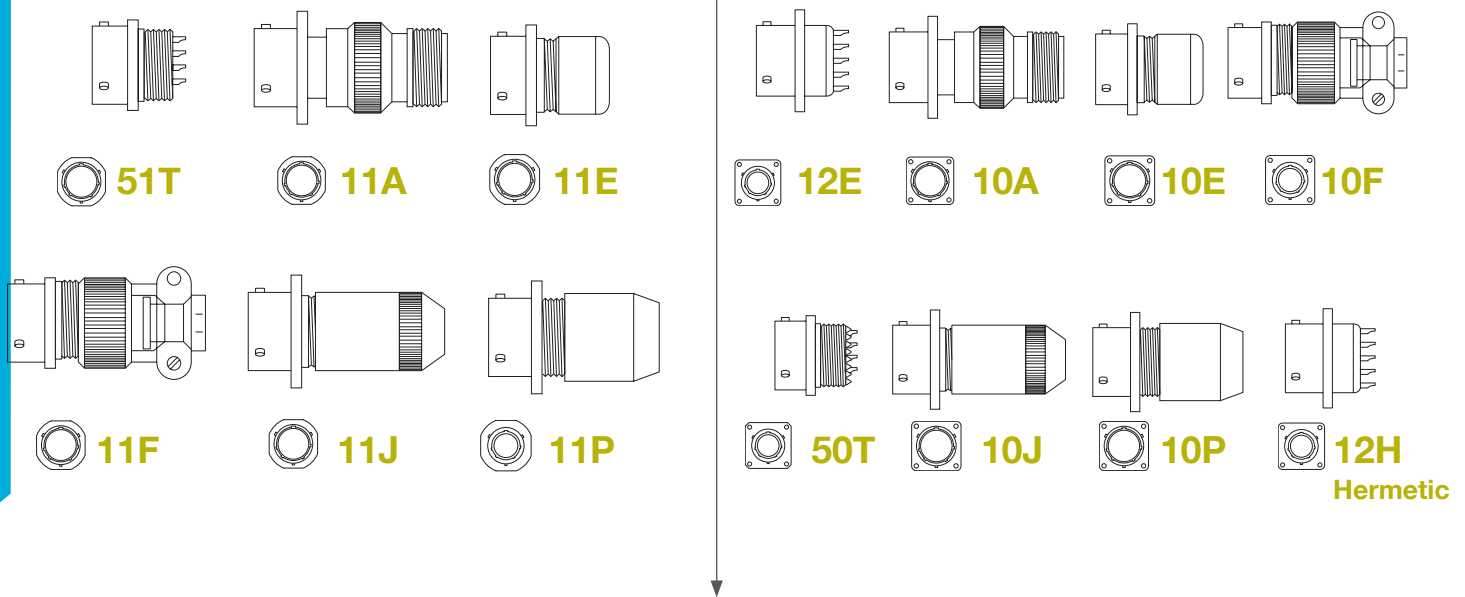

JAM NUT RECEPTACLES

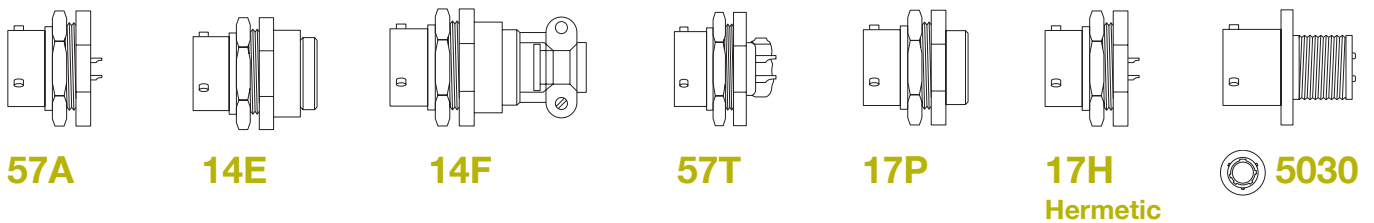

STYLE CODE

- A** = General-duty thread
- E** = Environmentally-sealed
- F** = Environmentally-sealed with strain relief

- J** = Environmentally-sealed with cable gland seal
- P** = Potting cup
- T** = Barrel/shell assembly with rear threads, no endbell

- TG** = Plug barrel (56 only) with rear threads, no endbell and EMI/RFI grounding fingers

STEP 2: SELECT LAYOUT

INSERT ARRANGEMENT	SERVICE RATING	TOTAL NUMBER OF CONTACTS	CONTACT SIZE				ORIENTATION ° (DEGREES)				
			20	16	12	8	NORMAL	W	X	Y	Z
08-02	I	2	2				0	58	122	-	-
08-03	I	3	3				0	60	210	-	-
08-33	I	3	3				0	90	-	-	-
08-04	I	4	4				0	45	-	-	-
08-98	I	3	3				0	-	-	-	-
10-02	II	2		2			0	-	-	-	-
10-06	I	6	6				0	90	-	-	-
10-07	I	7	7				0	-	-	-	-
12-03	II	3		3			0	-	-	180	-
12-08	I	8	8				0	90	112	203	292
12-10	I	10	10				0	60	155	270	295
12-14 †	I	14	14				0	-	-	-	-
14-02	II	2			2		0	-	-	-	-
14-04 †	I	4			4		0	45	-	-	-
14-05	II	5		5			0	40	92	184	273
14-12	I	12	8	4			0	43	90	-	-
14-15	I	15	14	1			0	17	110	155	234
14-19	I	19	19				0	30	165	315	-
14-22 †	III	5	1		4		0	45	-	-	-
16-04	III	4			4		0	-	-	-	-
16-08	II	8		8			0	54	152	180	331
16-23	I	23	22	1			0	158	270	-	-
16-26	I	26	26				0	60	-	275	338
18-11	II	11		11			0	62	119	241	340
18-02 †	III	2				2*	0	-	-	-	-
18-32	I	32	32				0	85	138	222	265
20-16	II	16		16			0	238	318	333	347
20-41	I	41	41				0	45	126	225	-
22-04 †	I	4				4*	0	-	-	-	-
22-55	I	55	55				0	30	142	226	314
24-61	I	61	61				0	90	180	270	32

*Size 8 crimp contact not available † = Grommet not available 10-76 layout available, see separate catalog.

STEP 3: SELECT CONTACT

P = Pin S = Socket

STEP 4: SELECT ROTATION OR KEYWAY

⇒ See chart above
N, W, X, Y, Z

⇒ See chart on page 153
A †, B, C, D †, E, F

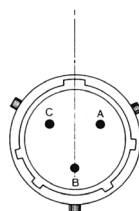

Normal position with pin contacts

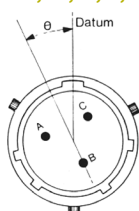

Alternative position of insert with socket contacts (∅ counterclockwise)

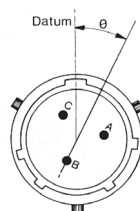

Alternative position of insert with pin contacts (∅ clockwise)

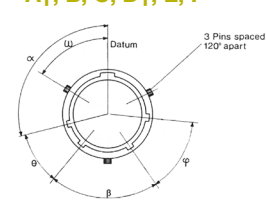

Shell size 8, E & F †Keying only. A & D keying inactive for new designs

STEP 5: SELECT MODIFIER (62GB ONLY)

- 044** = Rough-grip heavy-duty coupling nut (*plugs only*)
- 046** = Box-mount plug (*for 16 type only*)
- 214** = F-style endbell without wire-sealing grommet
- 219** = Printed circuit board (*12E & 57A only*)
- 297** = Mint-mark date code only
- 301** = Less contacts
- 518** = Less coupling nut
- 760** = Crimp contacts
- 964** = With grommet, no endbell
- SCC** = Self-closing cap flanged receptacles (*shell sizes 8, 10, 12 & 18*) only.

Shell Plating

(omit for standard green zinc) (RoHS)

- 714** = Olive drab chromate over cadmium
- 416#** = Electroless nickel (RoHS)
- 639** = Clear chromate over cadmium
- 608** = Black-anodized (RoHS) Non-conductive
- 771#** = Black Zinc Cobalt (RoHS)
- SS** = Stainless Steel use 62GBSS (RoHS)
- CU** = Brass use 62GBCU (RoHS)
- ZN** = Black Zinc-Nickel use 62ZN (RoHS) # Most Popular

LAYOUTS BY NUMBER OF CONTACTS

CONTACT LEGEND ○=20 ●=16 ◐=12 ◑=8
Mating-face view of pin inserts

SERIES LEGEND ■ = 62GB □ = 62GB and BS9522 F0017

CONTACTS	2				3					
SHELL SIZE/LAYOUT	08-02	10-02	14-02	18-02†	08-03	08-33	08-98	12-03		
# OF CONTACTS	2-#20	2-#16	2-#12	2-#8*	3-#20	3-#20	3-#20	3-#16		
SERVICE RATING	I	II	II	III	I	I	I	II		
SERIES	■	□	■	■	■	□	□	□		
CONTACTS	4				5		6			
SHELL SIZE/LAYOUT	08-04	14-04†	16-04	22-04†	14-05	14-22†	10-06			
# OF CONTACTS	4-#20	4-#12	4-#12	4-#8*	5-#16	1-#20, 4-#12	6-#20			
SERVICE RATING	I	I	III	I	II	III	I			
SERIES	■	■	■	■	□	■	□			
CONTACTS	7		8		10		11		12	
SHELL SIZE/LAYOUT	10-07	12-08	16-08	12-10	18-11	14-12				
# OF CONTACTS	7-#20	8-#20	8-#16	10-#20	11-#16	8-#20; 4-#16				
SERVICE RATING	I	II	II	I	II	II				
SERIES	□	■	□	□	□	□				
CONTACTS	14		15		16		19		23	
SHELL SIZE/LAYOUT	12-14†	14-15	20-16	14-19	16-23					
# OF CONTACTS	14-#20	1-#16; 14-#20	16-#16	19-#20	1-#16; 22-#20					
SERVICE RATING	I	II	II	I	I					
SERIES	■	□	□	□	■					
CONTACTS	26		32		41		55		61	
SHELL SIZE/LAYOUT	16-26	18-32	20-41	22-55	24-61					
# OF CONTACTS	26-#20	32-#20	41-#20	55-#20	61-#20					
SERVICE RATING	I	I	I	I	I					
SERIES	□	□	□	□	□					

* Size 8 crimp contact not available † = Grommet not available

CHOOSE KEYWAY ORIENTATIONS

SHELL SIZE	† KEYING	VALUES FOR α (DEGREES)	VALUES FOR θ (DEGREES)	VALUES FOR β (DEGREES)	VALUES FOR ψ (DEGREES)	VALUES FOR ω (DEGREES)
8	N	105	35	75	50	60
	A	92	35	75	50	47
	B	-	-	-	50	-
	C	-	-	-	50	-
	E	118	30	100	30	73
	F	82	50	75	45	47
10	N	105	35	75	50	60
	A	95	35	75	50	50
	B	85	35	75	50	40
	C	125	35	75	50	80
	D	115	35	75	50	70
	E	115	30	100	30	70
12	F	85	50	75	45	50
	N	105	35	75	50	60
	A	97	35	75	50	52
	B	89	35	75	50	44
	C	121	35	75	50	76
	D	113	35	75	50	68
14	E	115	30	100	30	70
	F	85	50	75	45	50
	N	105	35	75	50	60
	A	98	35	75	50	53
	B	91	35	75	50	46
	C	119	35	75	50	74
16	D	112	35	75	50	67
	E	75	30	100	30	30
	F	120	50	75	35	75
	N	105	35	75	50	60
	A	99	35	75	50	54
	B	93	35	75	50	48
18	C	117	35	75	50	72
	D	111	35	75	50	66
	E	75	30	100	30	30
	F	120	50	75	35	75
	N	105	35	75	50	60
	A	100	35	75	50	55
20	B	95	35	75	50	50
	C	115	35	75	50	70
	D	110	35	75	50	65
	E	75	30	100	30	30
	F	120	50	75	35	75
	N	105	35	75	50	60
22	A	101	35	75	50	56
	B	97	35	75	50	52
	C	113	35	100	50	68
	D	109	35	75	50	64
	E	75	30	75	30	30
	F	120	50	75	35	75
24	N	105	35	75	50	60
	A	101	35	75	50	56
	B	97	35	75	50	52
	C	113	35	75	50	68
	D	109	35	75	50	64
	E	75	30	100	30	30
F	120	50	75	35	75	

† Keying only. A & D keying inactive for new designs

COMPONENTS

O-Ring



Barrel/
Shell



Wave Spring



Coupling Nut



Lock Ring



Insert/
Insulator



Contacts



Wire Sealing
Grommet



Ferrule/
Compression
Ring



Endbell/
Cable Clamp



RECEPTACLE STYLES

62GB12E

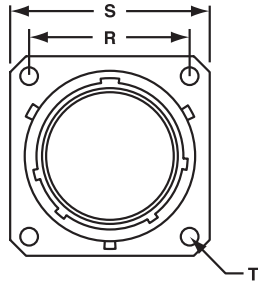

62GB50T

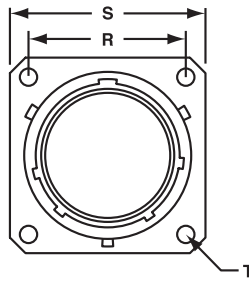

62GB51T

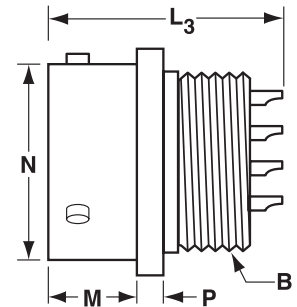
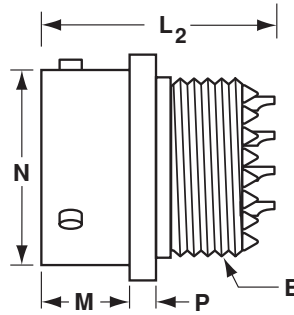
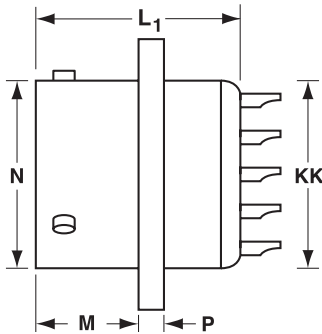
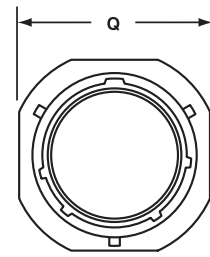

SHELL SIZE	62GB12/50/51/10/11			62GB12/50			62GB12E		62GB50T/62GB51T			
	M ±.005 (±0.13)	N ±.001 (±.055)	P ±.005 (±0.13)	R (TP)	S	T	L ₁	KK DIA. MAX.	L ₂	L ₃	B THREAD CLASS 2A	Q MAX. SQ.
8	0.445 (11.3)	0.473 (12.0)	0.062 (1.6)	0.594 (15.1)	0.817 (20.8)	0.120 (3.0)	0.800 (20.3)	.434 (11.0)	0.978 (24.8)	0.978 (24.8)	.4375-28 UNEF	.817 (20.8)
10	0.445 (11.3)	0.590 (15.0)	0.062 (1.6)	0.719 (18.3)	0.942 (23.9)	0.120 (3.0)	0.800 (20.3)	.558 (14.2)	0.978 (24.8)	0.978 (24.8)	.5625-24 UNEF	.942 (23.9)
12	0.445 (11.3)	0.750 (19.1)	0.062 (1.6)	0.812 (20.6)	1.036 (26.3)	0.120 (3.0)	0.800 (20.3)	.683 (17.3)	0.978 (24.8)	0.978 (24.8)	.6875-24 UNEF	1.036 (26.3)
14	0.445 (11.3)	0.875 (22.2)	0.062 (1.6)	0.906 (23.0)	1.130 (28.7)	0.120 (3.0)	0.800 (20.3)	.808 (20.5)	0.978 (24.8)	0.978 (24.8)	.8125-20 UNEF	1.130 (28.7)
16	0.445 (11.3)	1.000 (25.4)	0.062 (1.6)	0.969 (24.6)	1.223 (31.1)	0.120 (3.0)	0.800 (20.3)	.933 (23.7)	0.978 (24.8)	0.978 (24.8)	.9375-20 UNEF	1.223 (31.0)
18	0.445 (11.3)	1.125 (28.6)	0.062 (1.6)	1.062 (27.0)	1.317 (33.5)	0.120 (3.0)	0.800 (20.3)	1.057 (26.8)	0.978 (24.8)	0.978 (24.8)	1.0625-18 UNEF	1.317 (33.4)
20	0.555 (14.1)	1.250 (31.8)	0.080 (2.0)	1.156 (29.4)	1.442 (36.6)	0.120 (3.0)	0.875 (22.2)	1.182 (30.0)	1.048 (26.6)	1.048 (26.6)	1.1875-18 UNEF	1.442 (36.6)
22	0.555 (14.1)	1.375 (34.9)	0.080 (2.0)	1.250 (31.8)	1.567 (39.8)	0.120 (3.0)	0.875 (22.2)	1.307 (33.2)	1.048 (26.6)	1.048 (26.6)	1.3125-18 UNEF	1.567 (39.8)
24	0.590 (15.0)	1.500 (38.1)	0.080 (2.0)	1.375 (34.9)	1.692 (43.0)	0.147 (3.7)	0.875 (22.2)	1.432 (36.4)	1.048 (26.6)	1.048 (26.6)	1.4375-18 UNEF	1.692 (43.0)

NOTE: ➡ See page 157 for panel cutouts/thickness.

All dimensions in inches (millimeters in parenthesis)

ENDBELL STYLES

62GB10A
62GB11A

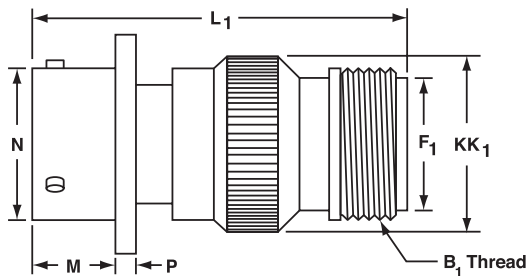

62GB10E
62GB11E

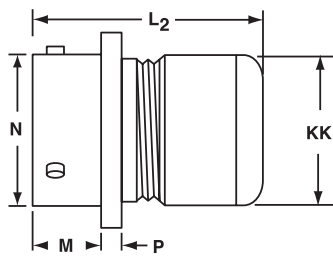

62GB10F
62GB11F

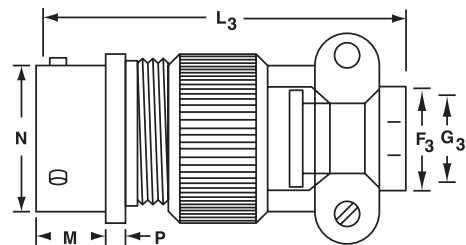

62GB10P
62GB11P

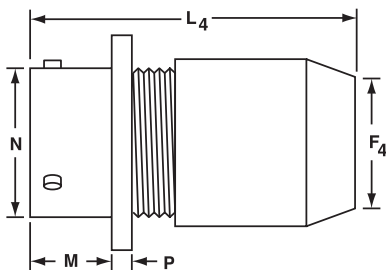

62GB10J
62GB11J

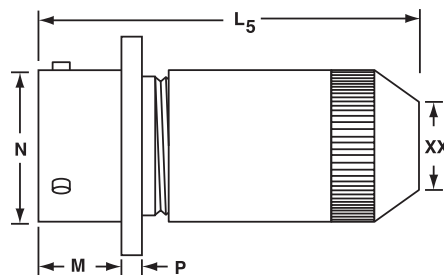

62GB10A/11A				62GB10E/11E		62GB10F/11F			62GB10P/11P		62GB10J/11J		
F ₁	L ₁	KK1 DIA. MAX.	B1 THREAD CLASS 2A	L ₂	KK2 DIA. MAX.	F ₃	G ₃	L ₃	F ₄	L ₄	L ₅	XX MIN.	XX MAX.
0.297 (7.5)	1.624 (41.2)	0.561 (14.2)	.5000-28 UNEF	1.281 (32.5)	0.561 (14.2)	0.240 (6.1)	0.156 (4.0)	1.762 (44.8)	0.260 (6.6)	1.453 (36.9)	1.846 (46.9)	0.168 (4.3)	0.230 (5.8)
0.421 (10.7)	1.624 (41.2)	0.686 (17.4)	.6250-24 UNEF	1.281 (32.5)	0.686 (17.4)	0.302 (7.7)	0.188 (4.8)	1.762 (44.8)	0.463 (11.8)	1.453 (36.9)	1.846 (46.9)	0.205 (5.2)	0.312 (7.9)
0.546 (13.9)	1.624 (41.2)	0.811 (20.6)	.7500-20 UNEF	1.281 (32.5)	0.811 (20.6)	0.428 (10.9)	0.312 (7.9)	1.762 (44.8)	0.577 (14.7)	1.453 (36.9)	1.947 (49.5)	0.338 (8.6)	0.442 (11.2)
0.663 (16.8)	1.624 (41.2)	0.936 (23.8)	.8750-20 UNEF	1.281 (32.5)	0.936 (23.8)	0.552 (14.0)	0.375 (9.5)	1.736 (44.1)	0.590 (15.0)	1.453 (36.9)	2.147 (54.5)	0.416 (10.6)	0.539 (13.7)
0.787 (20.0)	1.624 (41.2)	1.061 (26.9)	1.0000-20 UNEF	1.281 (32.5)	1.061 (26.9)	0.615 (15.6)	0.500 (12.7)	1.876 (47.7)	0.713 (18.1)	1.453 (36.9)	2.347 (59.6)	0.550 (14.0)	0.616 (15.6)
0.879 (22.3)	1.624 (41.2)	1.186 (30.1)	1.1875-18 UNEF	1.281 (32.5)	1.186 (30.1)	0.740 (18.8)	0.625 (15.9)	1.876 (47.7)	0.835 (21.2)	1.453 (36.9)	2.547 (64.7)	0.600 (15.2)	0.672 (17.1)
1.014 (25.8)	1.687 (42.8)	1.311 (33.3)	1.1875-18 UNEF	1.383 (35.1)	1.311 (33.3)	0.740 (18.8)	0.625 (15.9)	2.118 (53.8)	1.015 (25.8)	1.672 (42.5)	2.831 (71.9)	0.635 (16.1)	0.747 (19.0)
1.134 (28.8)	1.687 (42.8)	1.436 (36.5)	1.4375-18 UNEF	1.383 (35.1)	1.436 (36.5)	0.928 (23.6)	0.750 (19.1)	2.118 (53.8)	1.015 (25.8)	1.672 (42.5)	3.031 (77.0)	0.670 (17.0)	0.846 (21.5)
1.259 (32.0)	1.730 (43.9)	1.561 (39.6)	1.4375-18 UNEF	1.383 (35.1)	1.561 (39.6)	0.990 (25.1)	0.800 (20.3)	2.250 (57.2)	1.265 (32.1)	1.734 (44.0)	3.074 (78.1)	0.740 (18.8)	0.894 (22.7)

All dimensions in inches (millimeters in parenthesis)

STRAIGHT PLUG

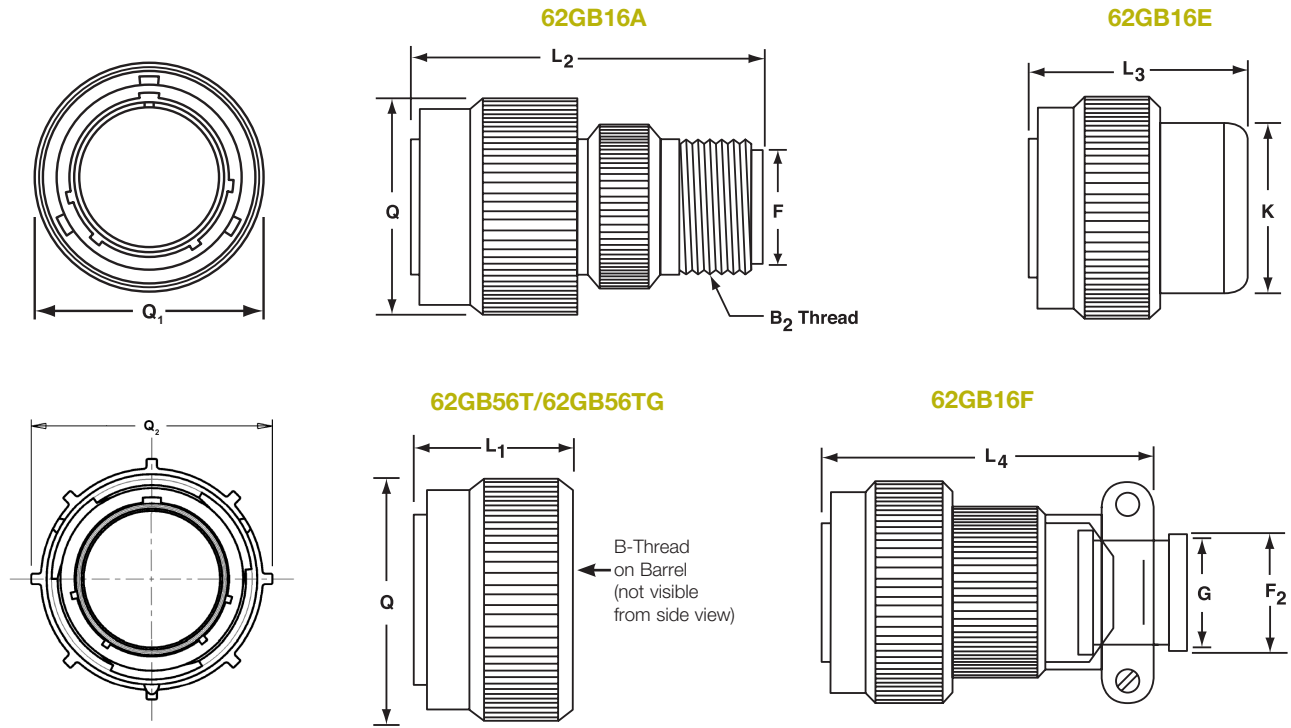

SHELL SIZE	62GB56T/62GB56TG				62GB16A			62GB12E		62GB16F		
	Q ₁ MAX.	Q ₂ +.005 / .004 (+.18 / .11)	L ₁ MAX.	B THREAD CLASS 2A	F	L ₂	B THREAD CLASS 2A	L ₃	K MAX.	F ₂	G	L ₄
8	0.750 (19.1)	0.865 (21.97)	0.976 (24.8)	.4375-28 UNEF	0.297 (7.5)	1.614 (41.0)	.5000-28 UNEF	1.281 (32.5)	0.561 (14.2)	0.240 (6.1)	0.156 (4.0)	1.752 (44.5)
10	0.859 (21.8)	0.986 (25.04)	0.976 (24.8)	.5625-24 UNEF	0.421 (10.7)	1.614 (41.0)	.6250-24 UNEF	1.281 (32.5)	0.686 (17.4)	0.302 (7.7)	0.188 (4.8)	1.752 (44.5)
12	1.013 (25.7)	1.137 (28.88)	0.976 (24.8)	.6875-24 UNEF	0.546 (13.9)	1.614 (41.0)	.7500-20 UNEF	1.281 (32.5)	0.811 (20.6)	0.428 (10.9)	0.312 (7.9)	1.752 (44.5)
14	1.156 (29.4)	1.262 (32.05)	0.976 (24.8)	.8125-20 UNEF	0.663 (16.8)	1.614 (41.0)	.8750-20 UNEF	1.281 (32.5)	0.936 (23.8)	0.552 (14.0)	0.375 (9.5)	1.726 (43.8)
16	1.281 (32.5)	1.396 (35.46)	0.976 (24.8)	.9375-20 UNEF	0.787 (20.0)	1.614 (41.0)	1.0000-20 UNEF	1.281 (32.5)	1.061 (26.9)	0.615 (15.6)	0.500 (12.7)	1.866 (47.4)
18	1.319 (33.5)	1.500 (38.10)	0.976 (24.8)	1.0625-18 UNEF	0.879 (22.3)	1.614 (41.0)	1.1875-18 UNEF	1.281 (32.5)	1.186 (30.1)	0.740 (18.8)	0.625 (15.9)	1.866 (47.4)
20	1.531 (38.9)	1.646 (41.81)	0.976 (24.8)	1.1875-18 UNEF	1.014 (25.8)	1.614 (41.0)	1.1875-18 UNEF	1.281 (32.5)	1.311 (33.3)	0.740 (18.8)	0.625 (15.9)	2.040 (51.8)
22	1.656 (42.1)	1.771 (44.98)	0.976 (24.8)	1.3125-18 UNEF	1.134 (28.8)	1.614 (41.0)	1.4375-18 UNEF	1.281 (32.5)	1.436 (36.5)	0.928 (23.6)	0.750 (19.1)	2.040 (51.8)
24	1.777 (45.1)	1.892 (48.06)	0.976 (24.8)	1.4375-18 UNEF	1.259 (32.0)	1.658 (42.1)	1.4375-18 UNEF	1.281 (32.5)	1.561 (39.6)	0.990 (25.1)	0.800 (20.3)	2.178 (55.3)

All dimensions in inches (millimeters in parenthesis)

STRAIGHT PLUG STYLES

62GB16P

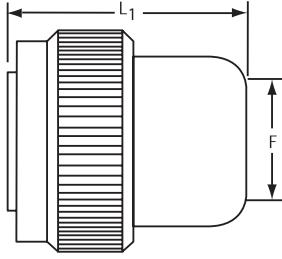

62GB16J

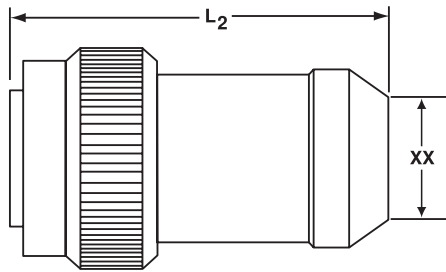

62GB16P		62GB16J		
F	L ₁	L ₂	CABLE OD	
			XX MIN.	XX MAX.
0.260 (6.6)	1.306 (33.2)	1.836 (46.6)	0.168 (4.3)	0.230 (5.8)
0.463 (11.8)	1.415 (35.9)	1.836 (46.6)	0.205 (5.2)	0.312 (7.9)
0.557 (14.1)	1.384 (35.2)	1.937 (49.2)	0.338 (8.6)	0.442 (11.2)
0.590 (15.0)	1.384 (35.2)	2.137 (54.3)	0.416 (10.6)	0.539 (13.7)
0.713 (18.1)	1.384 (35.2)	2.337 (59.4)	0.550 (14.0)	0.616 (15.6)
0.835 (21.2)	1.384 (35.2)	2.537 (64.4)	0.600 (15.2)	0.672 (17.1)
1.015 (25.8)	1.539 (39.1)	2.758 (70.1)	0.635 (16.1)	0.747 (19.0)
1.015 (25.8)	1.539 (39.1)	2.958 (75.1)	0.670 (17.0)	0.846 (21.5)
1.265 (32.1)	1.602 (40.7)	3.002 (76.3)	0.740 (18.8)	0.894 (22.7)

PANEL CUTOUT/THICKNESS

62GB12E
62GB50T
62GB10

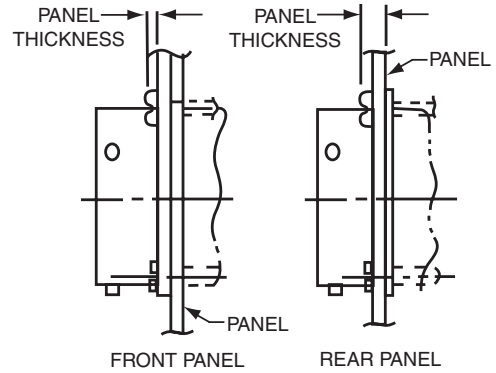
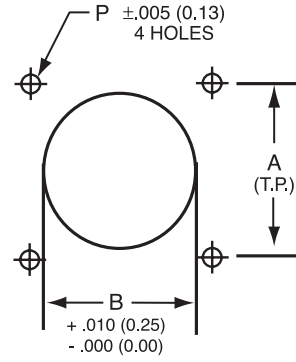

SHELL SIZE	B FRONT MOUNT	A	P ±.005	SCREW SIZE	PANEL THICKNESS
8	0.449 (11.4)	0.594 (15.1)	0.125 (3.2)	#4	0.087 (2.2)
10	0.573 (14.6)	0.719 (18.3)	0.125 (3.2)	#4	0.087 (2.2)
12	0.699 (17.8)	0.812 (20.6)	0.125 (3.2)	#4	0.087 (2.2)
14	0.823 (20.9)	0.906 (23.0)	0.125 (3.2)	#4	0.087 (2.2)
16	0.949 (24.1)	0.969 (24.6)	0.125 (3.2)	#4	0.087 (2.2)
18	1.073 (27.3)	1.062 (27.0)	0.125 (3.2)	#4	0.087 (2.2)
20	1.199 (30.5)	1.156 (29.4)	0.125 (3.2)	#4	0.212 (5.4)
22	1.323 (33.6)	1.250 (31.8)	0.125 (3.2)	#4	0.212 (5.4)
24	1.449 (36.8)	1.375 (34.9)	0.155 (3.9)	#6	0.212 (5.4)

All dimensions in inches (millimeters in parenthesis)

JAM NUT RECEPTACLES

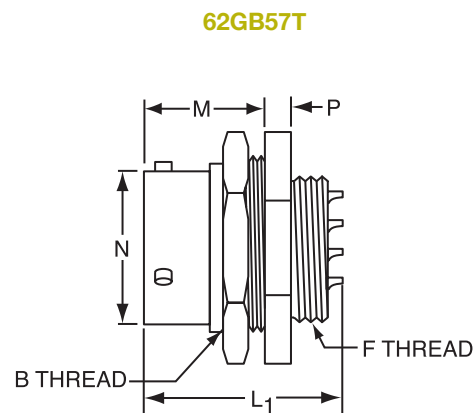
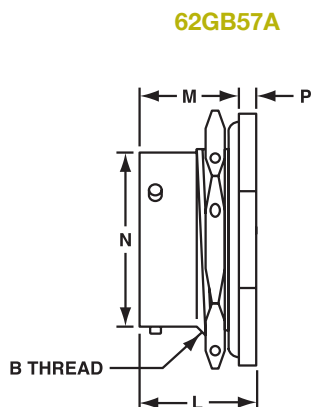
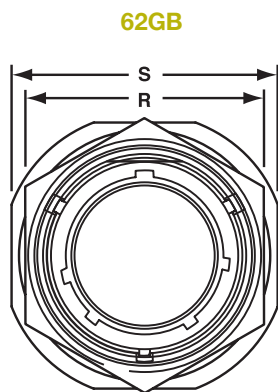

SHELL SIZE	62GB57/62GB17P							PANEL THICKNESS	
	B THREAD CLASS 2A	M ±.005 (± 0.13)	N	P ±.005 (± 0.13)	R	S	J MIN.	J MAX.	
	8	.5625-24 UNEF	0.706 (17.9)	0.473 (12.0)	0.117 (3.0)	0.750 (19.1)	0.942 (23.9)	0.062 (1.6)	0.125 (3.2)
10	.6875-24 UNEF	0.706 (17.9)	0.590 (15.0)	0.117 (3.0)	0.875 (22.2)	1.067 (27.1)	0.062 (1.6)	0.125 (3.2)	
12	.8750-20 UNEF	0.706 (17.9)	0.750 (19.1)	0.117 (3.0)	1.062 (27.0)	1.255 (31.9)	0.062 (1.6)	0.125 (3.2)	
14	1.0000-20 UNEF	0.706 (17.9)	0.875 (22.2)	0.117 (3.0)	1.187 (30.1)	1.380 (35.1)	0.062 (1.6)	0.125 (3.2)	
16	1.1250-18 UNEF	0.706 (17.9)	1.000 (25.4)	0.117 (3.0)	1.312 (33.3)	1.505 (38.2)	0.062 (1.6)	0.125 (3.2)	
18	1.2500-18 UNEF	0.706 (17.9)	1.125 (28.6)	0.117 (3.0)	1.437 (36.5)	1.630 (41.4)	0.062 (1.6)	0.125 (3.2)	
20	1.3750-18 UNEF	0.894 (22.7)	1.250 (31.8)	0.148 (3.8)	1.562 (39.7)	1.817 (46.2)	0.062 (1.6)	0.250 (6.4)	
22	1.5000-18 UNEF	0.894 (22.7)	1.375 (34.9)	0.148 (3.8)	1.687 (42.8)	1.942 (49.3)	0.062 (1.6)	0.250 (6.4)	
24	1.6250-18 UNEF	0.927 (23.5)	1.500 (38.1)	0.148 (3.8)	1.812 (46.0)	2.067 (52.5)	0.062 (1.6)	0.250 (6.4)	

62GB57A

L MAX.
0.823 (20.9)
0.823 (20.9)
0.823 (20.9)
0.823 (20.9)
0.823 (20.9)
0.823 (20.9)
1.042 (26.5)
1.042 (26.5)
1.075 (27.3)

62GB57T

L ₁ MAX.	F THREAD CLASS 2A
0.978 (24.8)	.4375-28 UNEF
0.978 (24.8)	.5625-24 UNEF
0.978 (24.8)	.6875-24 UNEF
0.978 (24.8)	.8125-20 UNEF
0.978 (24.8)	.9375-20 UNEF
0.978 (24.8)	1.0625-18 UNEF
1.048 (26.6)	1.1875-18 UNEF
1.048 (26.6)	1.3125-18 UNEF
1.048 (26.6)	1.4375-18 UNEF

All dimensions in inches (millimeters in parenthesis)

JAM NUT RECEPTACLES

62GB14E

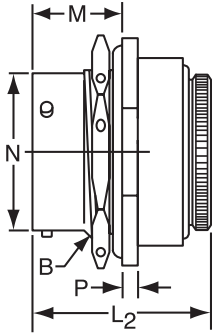

62GB14F

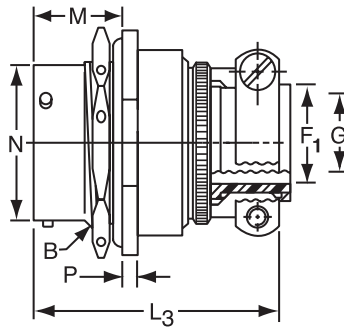

62GB17P

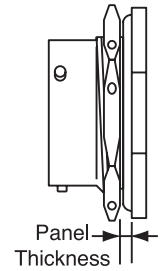
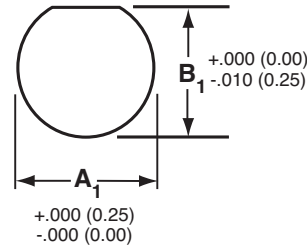
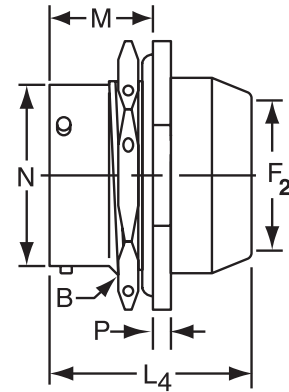

62GB14E	
L ₂ MAX.	
1.344	(34.1)
1.344	(34.1)
1.344	(34.1)
1.344	(34.1)
1.344	(34.1)
1.344	(34.1)
1.344	(34.1)
1.344	(34.1)
1.576	(40.0)
1.576	(40.0)
1.609	(40.9)

62GB14F		
F ₁ MIN.	G ±0.005 (±0.13)	L ₃
0.240	0.156 (4.0)	1.762 (44.8)
0.302	0.188 (4.8)	1.762 (44.8)
0.428	0.312 (7.9)	1.762 (44.8)
0.552	0.375 (9.5)	1.762 (44.8)
0.615	0.500 (12.7)	1.876 (47.7)
0.740	0.625 (15.9)	1.876 (47.7)
0.740	0.625 (15.9)	2.118 (53.8)
0.928	0.750 (19.1)	2.118 (53.8)
0.990	0.800 (20.3)	2.250 (57.2)

62GB17P	
F ₂	L ₄
0.260	1.391 (35.3)
0.463	1.391 (35.3)
0.577	1.391 (35.3)
0.590	1.391 (35.3)
0.713	1.391 (35.3)
0.835	1.391 (35.3)
1.015	1.641 (41.7)
1.015	1.641 (41.7)
1.265	1.674 (42.5)

SHELL SIZE	A1 +010-.000 (+.25-.00)	B1 +.000-.010 (+.00-.25)	PANEL THICKNESS	
			MIN.	MAX.
8	0.572 (14.5)	0.542 (13.8)	0.062 (1.6)	0.125 (3.2)
10	0.697 (17.7)	0.669 (17.0)	0.062 (1.6)	0.125 (3.2)
12	0.884 (22.5)	0.830 (21.1)	0.062 (1.6)	0.125 (3.2)
14	1.007 (25.6)	0.955 (24.3)	0.062 (1.6)	0.125 (3.2)
16	1.134 (28.8)	1.084 (27.5)	0.062 (1.6)	0.125 (3.2)
18	1.259 (32.0)	1.208 (30.7)	0.062 (1.6)	0.125 (3.2)
20	1.384 (35.2)	1.333 (33.9)	0.062 (1.6)	0.250 (6.4)
22	1.507 (38.3)	1.459 (37.1)	0.062 (1.6)	0.250 (6.4)
24	1.634 (41.5)	1.575 (40.0)	0.062 (1.6)	0.250 (6.4)

All dimensions in inches (millimeters in parenthesis)

RECEPTACLES

PCB BOX MOUNT
62GB-12E-219

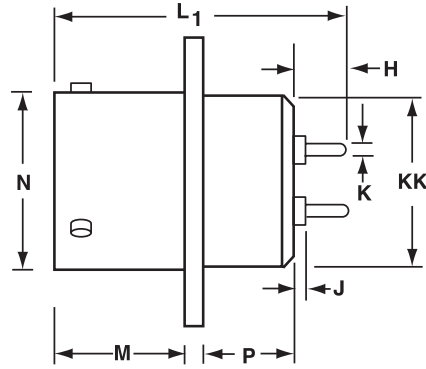
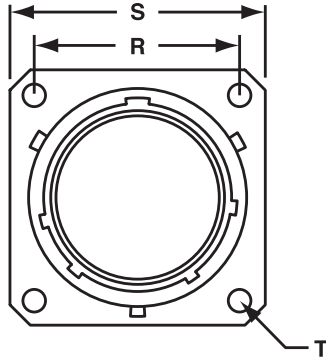

62GB12E-219

SHELL SIZE	M ±.005 (± 0.13)	N +.001 -.055	P	R (TP)	S	T DIA.	L ₁ MAX.	H MAX.	H MIN.	KK DIA. MAX.	K +/- .001 (0.025)	J +/- .020 (0.51)
8	0.445 (11.3)	0.473 (12.0)	0.062 (1.6)	0.594 (15.1)	0.817 (20.8)	0.120 (3.0)	0.982 (24.85)	0.198 (5.03)	0.166 (4.22)	0.434 (11.0)	0.029 (0.73)	0.089 (2.26)
10	0.445 (11.3)	0.590 (15.0)	0.062 (1.6)	0.719 (18.3)	0.992 (23.9)	0.120 (3.0)	0.982 (24.85)	0.198 (5.03)	0.166 (4.22)	0.558 (14.2)	0.029 (0.73)	0.089 (2.26)
12	0.445 (11.3)	0.750 (19.1)	0.062 (1.6)	0.812 (20.6)	1.036 (26.3)	0.120 (3.0)	0.982 (24.85)	0.198 (5.03)	0.166 (4.22)	0.683 (17.3)	0.029 (0.73)	0.089 (2.26)
14	0.445 (11.3)	0.875 (22.2)	0.062 (1.6)	0.906 (23.0)	1.130 (28.7)	0.120 (3.0)	0.982 (24.85)	0.198 (5.03)	0.166 (4.22)	0.808 (20.5)	0.029 (0.73)	0.089 (2.26)
16	0.445 (11.3)	1.000 (25.4)	0.062 (1.6)	0.969 (24.6)	1.223 (31.1)	0.120 (3.0)	0.982 (24.85)	0.198 (5.03)	0.166 (4.22)	0.933 (23.7)	0.029 (0.73)	0.089 (2.26)
18	0.445 (11.3)	1.125 (28.6)	0.062 (1.6)	1.062 (27.0)	1.317 (33.5)	0.120 (3.0)	0.982 (24.85)	0.198 (5.03)	0.166 (4.22)	1.057 (26.8)	0.029 (0.73)	0.089 (2.26)
20	0.555 (14.1)	1.250 (31.8)	0.080 (2.4)	1.156 (29.4)	1.442 (36.6)	0.120 (3.0)	1.057 (26.85)	0.185 (4.70)	0.153 (3.89)	1.182 (30.0)	0.029 (0.73)	0.076 (1.93)
22	0.555 (14.1)	1.375 (34.9)	0.080 (2.4)	1.250 (31.8)	1.567 (39.8)	0.120 (3.0)	1.057 (26.85)	0.185 (4.70)	0.153 (3.89)	1.307 (33.2)	0.029 (0.73)	0.076 (1.93)
24	0.590 (15.0)	1.500 (38.1)	0.080 (3.2)	1.375 (34.9)	1.692 (43.0)	0.147 (3.7)	1.057 (26.85)	0.185 (4.70)	0.153 (3.89)	1.432 (36.4)	0.029 (0.73)	0.076 (1.93)

All dimensions in inches (millimeters in parenthesis)

RECEPTACLES

PCB JAM NUT
62GB57A-219

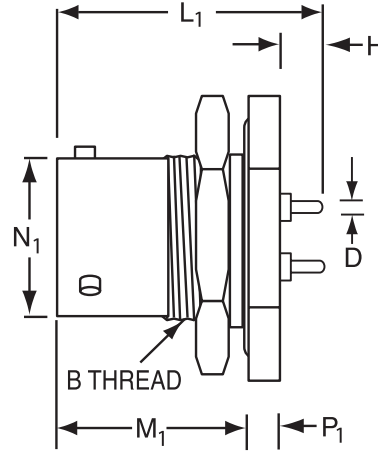
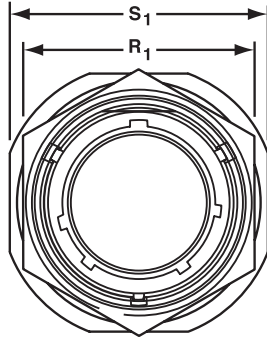

62GB-57A-219										
SHELL SIZE	B THREAD CLASS 2A	M ₁ ±.005 (± 0.13)	N ₁	P ₁ ±.005 (± 0.13)	R ₁	S ₁	L ₁ MAX.	H MIN.	H MAX.	D +/- .001 (0.025)
8	.5625-24	0.706	0.473	0.117	0.750	0.942	0.976	0.133	0.173	0.029
	UNEF	(17.9)	(12.0)	(3.0)	(19.1)	(23.9)	(24.79)	(3.38)	(4.40)	(0.73)
10	.6875-24	0.706	0.590	0.117	0.875	1.067	0.976	0.133	0.173	0.029
	UNEF	(17.9)	(15.0)	(3.0)	(22.2)	(27.1)	(24.79)	(3.38)	(4.40)	(0.73)
12	.8750-20	0.706	0.750	0.117	1.062	1.255	0.976	0.133	0.173	0.029
	UNEF	(17.9)	(19.1)	(3.0)	(27.0)	(31.9)	(24.79)	(3.38)	(4.40)	(0.73)
14	1.0000-20	0.706	0.875	0.117	1.187	1.380	0.976	0.133	0.173	0.029
	UNEF	(17.9)	(22.2)	(3.0)	(30.1)	(35.1)	(24.79)	(3.38)	(4.40)	(0.73)
16	1.1250-18	0.706	1.000	0.117	1.312	1.505	0.976	0.133	0.173	0.029
	UNEF	(17.9)	(25.4)	(3.0)	(33.3)	(38.2)	(24.79)	(3.38)	(4.40)	(0.73)
18	1.2500-18	0.706	1.125	0.117	1.437	1.630	0.976	0.133	0.173	0.029
	UNEF	(17.9)	(28.6)	(3.0)	(36.5)	(41.4)	(24.79)	(3.38)	(4.40)	(0.73)
20	1.3750-18	0.894	1.250	0.148	1.562	1.817	1.195	0.133	0.173	0.029
	UNEF	(22.7)	(31.8)	(3.8)	(39.7)	(46.2)	(30.35)	(3.38)	(4.40)	(0.73)
22	1.5000-18	0.894	1.375	0.148	1.687	1.942	1.195	0.133	0.173	0.029
	UNEF	(22.7)	(34.9)	(3.8)	(42.8)	(49.3)	(30.35)	(3.38)	(4.40)	(0.73)
24	1.6250-18	0.927	1.500	0.148	1.812	2.067	1.228	0.133	0.173	0.029
	UNEF	(23.5)	(38.1)	(3.8)	(46.0)	(52.5)	(31.19)	(3.38)	(4.40)	(0.73)

All dimensions in inches (millimeters in parenthesis)

CRIMP CONTACTS

PINS



Size	Wire Size AWG	Pin	Wire Strip Lengths Inches (mm)	Wire Sealing Range Inches (mm)		Wire Hole Filler*	Hand Crimp Tool	Power Crimp Tool †	Turret Head	Use Turret Head Locator Color	Metal Insertion Tool	Metal Extraction Tool
				Max.	Min.							
20	20-24	62-1525	.314 (8.00)	.047 (1.19)	.085 (2.16)	MS27488-20-2	M22520/1-01	WA27F	M22520/1-04	RED	62GB-20-INS	62GB-20-EXT
16	16-20	62-1708	.314 (8.00)	.066 (1.68)	.109 (2.77)	MS27488-16-2	M22520/1-01	WA27F	M22520/1-02	BLUE	62GB-16-INS	62GB-16-EXT
12	12-14	62-1621	.314 (8.00)	.097 (2.46)	.142 (3.78)	MS27488-12-2	M22520/1-01	WA27F	M22520/1-02	YELLOW	62GB-12-INS	62GB-12-EXT

† Contact us for more tool accessories.
Note: Size 8 contacts not available in crimp.
 *Insert head first. Trim off excess.

SOCKETS



Size	Wire Size AWG	Socket	Wire Strip Lengths Inches (mm)	Wire Sealing Range Inches (mm)		Wire Hole Filler*	Hand Crimp Tool	Power Crimp Tool †	Turret Head	Use Turret Head Locator Color	Metal Insertion Tool	Metal Extraction Tool
				Max.	Min.							
20	20-24	62-1563	.314 (8.00)	.047 (1.19)	.085 (2.16)	MS27488-20-2	M22520/1-01	WA27F	M22520/1-04	RED	62GB-20-INS	62GB-20-EXT
16	16-20	62-1698	.314 (8.00)	.066 (1.68)	.109 (2.77)	MS27488-16-2	M22520/1-01	WA27F	M22520/1-02	BLUE	62GB-16-INS	62GB-16-EXT
12	12-14	62-1670	.314 (8.00)	.097 (2.46)	.142 (3.78)	MS27488-12-2	M22520/1-01	WA27F	M22520/1-02	YELLOW	62GB-12-INS	62GB-12-EXT

† Contact us for more tool accessories.
Note: Size 8 contacts not available in crimp.
 *Insert head first. Trim off excess.

ENDBELLS OR TYPE T CONNECTORS

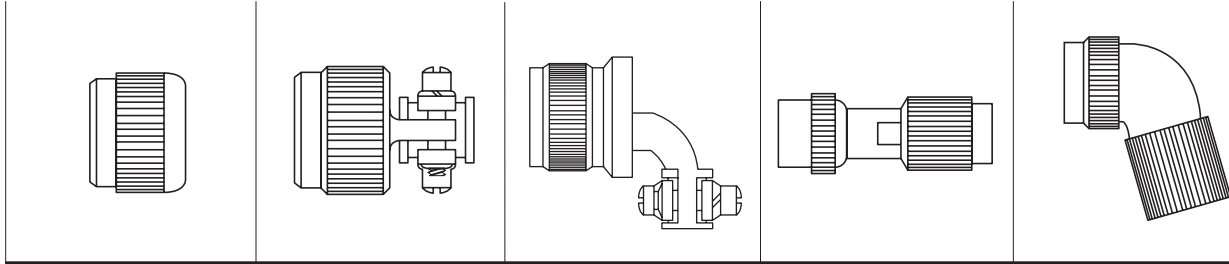

62GB GROMMET KITS

SIZE	SHELL E ENDBELL	F ENDBELL	RIGHT ANGLE ENDBELL	SHIELDED GLAND SEAL ENDBELLS (SCREENED)	
				STRAIGHT	75 DEGREE
08	62GB-584-08-XXP or S**	62GB-585-08-XXP or S**	62GB-711-08-XXP or S**	62GB-587-08-XXP or S**	62GB-5028-08-XXP or S**
10	62GB-584-10-XXP or S**	62GB-585-10-XXP or S**	62GB-711-10-XXP or S**	62GB-587-10-XXP or S**	62GB-5028-10-XXP or S**
12	62GB-584-12-XXP or S**	62GB-585-12-XXP or S**	62GB-711-12-XXP or S**	62GB-587-12-XXP or S**	62GB-5028-12-XXP or S**
14	62GB-584-14-XXP or S**	62GB-585-14-XXP or S**	62GB-711-14-XXP or S**	62GB-587-14-XXP or S**	62GB-5028-14-XXP or S**
16	62GB-584-16-XXP or S**	62GB-585-16-XXP or S**	62GB-711-16-XXP or S**	62GB-587-16-XXP or S**	62GB-5028-16-XXP or S**
18	62GB-584-18-XXP or S**	62GB-585-18-XXP or S**	62GB-711-18-XXP or S**	-	-
20	62GB-584-20-XXP or S**	62GB-585-20-XXP or S**	62GB-711-20-XXP or S**	62GB-587-20-XXP or S**	62GB-5028-20-XXP or S**
22	62GB-584-22-XXP or S**	62GB-585-22-XXP or S**	62GB-711-22-XXP or S**	62GB-587-22-XXP or S**	-
24	62GB-584-24-XXP or S**	62GB-585-24-XXP or S**	62GB-711-24-XXP or S**	62GB-587-24-XXP or S**	62GB-5028-24-XXP or S**

XX - Insert layout.

Add -214 for endbells where no grommet is available. Example: 62GB-585-12-14P-214

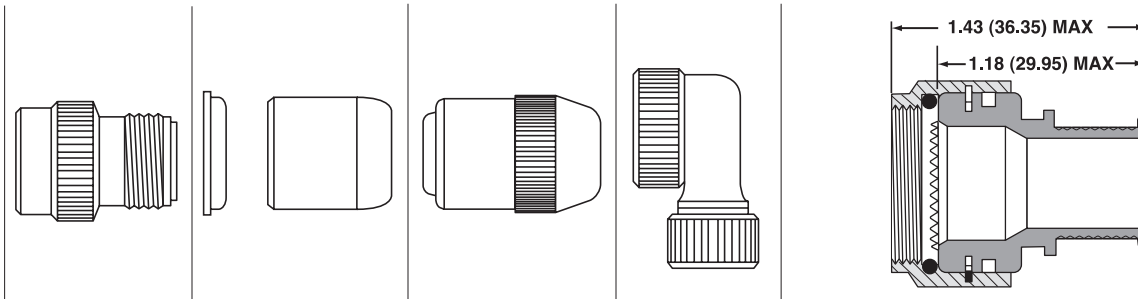

62GB ENDBELL KITS

SHELL SIZE	A ENDBELL	POTTING CUP (MOULD)	GLAND SEAL ENDBELL/GROMMET KIT		AIA-5001	CABLE EXIT MAX.	SPRING
			J ENDBELL	SHIELDED (SCREENED)			
08	62GB-776-08**	62GB-586-08	62GB-720-08**	62GB-1225-08**	AIA5001-08-00-00-10-AA**	.255 (6.48)	HE050
10	62GB-776-10**	62GB-586-10	62GB-720-10**	62GB-1225-10**	AIA5001-10-00-00-10-AA**	.317 (8.05)	HE100
12	62GB-776-12**	62GB-586-12	62GB-720-12**	62GB-1225-12**	AIA5001-12-00-00-10-AA**	.443 (11.25)	HE200
14	62GB-776-14**	62GB-586-14	62GB-720-14**	62GB-1225-14**	AIA5001-14-00-00-10-AA**	.505 (12.53)	HE200
16	62GB-776-16**	62GB-586-16	62GB-720-16**	-	AIA5001-16-00-00-10-AA**	.630 (16.00)	HE200
18	62GB-776-18**	62GB-586-18	62GB-720-18**	-	AIA5001-18-00-00-10-AA**	.755 (19.18)	HE300
20	62GB-776-20**	62GB-586-20	62GB-720-20**	-	AIA5001-20-00-00-10-AA**	.881 (22.38)	HE300
22	62GB-776-22**	62GB-586-22	62GB-720-22**	-	AIA5001-22-00-00-10-AA**	1.006 (25.55)	HE300
24	62GB-776-24**	62GB-586-24	62GB-720-24**	-	AIA5001-24-00-00-10-AA**	1.006 (25.55)	HE300

** = Plating Code (default) = Green Zinc Cobalt (RoHS)

771 = Black Zinc Cobalt (RoHS)

714 = Olive Drab Chromate over Cadmium

Other diameters available. Please contact us for more details.

416 = Electroless Nickel (RoHS)

608 = Black-Anodized (RoHS)

62ZN = Black Zinc Nickel (Replaces 62GB at front of part no.)

Please contact us for heat shrink boot.

DUST CAPS

CAP STYLES



Standard



Heavy Duty

LANYARD TYPES



Sash Chain



Polyester Cord

SHELL SIZE	CAP STYLE	LANYARD TYPE	PLUGS	RECEPTACLES			LANYARD LENGTH
				FLANGED	JAM NUT	IN-LINE	
8	Standard	Cord	62GB-810-08- XXX	62GB-812-08- XXX	62GB-813-08- XXX	62GB-814-08- XXX	3.00 (76.2)
	Arctic Grip		62GB-1069-08- XXX	62GB-1070-08- XXX	Not Available	Not Available	
	Standard	Chain	62GB-742-08- XXX	62GB-738-08- XXX	62GB-736-08- XXX	62GB-737-08- XXX	
	Arctic Grip		62GB-998-08- XXX	Not Available	62GB-997-08- XXX	Not Available	
10	Standard	Cord	62GB-810-10- XXX	62GB-812-10- XXX	62GB-813-10- XXX	62GB-814-10- XXX	3.00 (76.2)
	Arctic Grip		62GB-1069-10- XXX	62GB-1070-10- XXX	Not Available	Not Available	
	Standard	Chain	62GB-742-10- XXX	62GB-738-10- XXX	62GB-736-10- XXX	62GB-737-10- XXX	
	Arctic Grip		62GB-998-10- XXX	Not Available	62GB-997-10- XXX	Not Available	
12	Standard	Cord	62GB-810-12- XXX	62GB-812-12- XXX	62GB-813-12- XXX	62GB-814-12- XXX	3.50 (88.9)
	Arctic Grip		62GB-1069-12- XXX	62GB-1070-12- XXX	Not Available	Not Available	
	Standard	Chain	62GB-742-12- XXX	62GB-738-12- XXX	62GB-736-12- XXX	62GB-737-12- XXX	
	Arctic Grip		62GB-998-12- XXX	Not Available	62GB-997-12- XXX	Not Available	
14	Standard	Cord	62GB-810-14- XXX	62GB-812-14- XXX	62GB-813-14- XXX	62GB-814-14- XXX	3.50 (88.9)
	Arctic Grip		62GB-1069-14- XXX	62GB-1070-14- XXX	Not Available	Not Available	
	Standard	Chain	62GB-742-14- XXX	62GB-738-14- XXX	62GB-736-14- XXX	62GB-737-14- XXX	
	Arctic Grip		62GB-998-14- XXX	Not Available	62GB-997-14- XXX	Not Available	
16	Standard	Cord	62GB-810-16- XXX	62GB-812-16- XXX	62GB-813-16- XXX	62GB-814-16- XXX	3.50 (88.9)
	Arctic Grip		62GB-1069-16- XXX	62GB-1070-16- XXX	Not Available	Not Available	
	Standard	Chain	62GB-742-16- XXX	62GB-738-16- XXX	62GB-736-16- XXX	62GB-737-16- XXX	
	Arctic Grip		62GB-998-16- XXX	Not Available	62GB-997-16- XXX	Not Available	
18	Standard	Cord	62GB-810-18- XXX	62GB-812-18- XXX	62GB-813-18- XXX	62GB-814-18- XXX	3.50 (88.9)
	Arctic Grip		62GB-1069-18- XXX	62GB-1070-18- XXX	Not Available	Not Available	
	Standard	Chain	62GB-742-18- XXX	62GB-738-18- XXX	62GB-736-18- XXX	62GB-737-18- XXX	
	Arctic Grip		62GB-998-18- XXX	Not Available	62GB-997-18- XXX	Not Available	
20	Standard	Cord	62GB-810-20- XXX	62GB-812-20- XXX	62GB-813-20- XXX	62GB-814-20- XXX	4.00 (101.6)
	Arctic Grip		62GB-1069-20- XXX	62GB-1070-20- XXX	Not Available	Not Available	
	Standard	Chain	62GB-742-20- XXX	62GB-738-20- XXX	62GB-736-20- XXX	62GB-737-20- XXX	
	Arctic Grip		62GB-998-20- XXX	Not Available	62GB-997-20- XXX	Not Available	
22	Standard	Cord	62GB-810-22- XXX	62GB-812-22- XXX	62GB-813-22- XXX	62GB-814-22- XXX	4.00 (101.6)
	Arctic Grip		62GB-1069-22- XXX	62GB-1070-22- XXX	Not Available	Not Available	
	Standard	Chain	62GB-742-22- XXX	62GB-738-22- XXX	62GB-736-22- XXX	62GB-737-22- XXX	
	Arctic Grip		62GB-998-22- XXX	Not Available	62GB-997-22- XXX	Not Available	
24	Standard	Cord	62GB-810-24- XXX	62GB-812-24- XXX	62GB-813-24- XXX	62GB-814-24- XXX	4.00 (101.6)
	Arctic Grip		62GB-1069-24- XXX	62GB-1070-24- XXX	Not Available	Not Available	
	Standard	Chain	62GB-742-24- XXX	62GB-738-24- XXX	62GB-736-24- XXX	62GB-737-24- XXX	
	Arctic Grip		62GB-998-24- XXX	Not Available	62GB-997-24- XXX	Not Available	
Lanyard termination notes			Plug caps have small eyelets for mounting to cable clamp screw	Flanged recp. caps have small eyelets for securing to mounting screws	Jam nut recp. caps have large eyelets for securing under mounting nut	In-line recp. caps have large eyelets for securing on accessory thread	For modified lanyard lengths please use codes below

Modification codes:

- XXX = Plating codes**
- Omit = Green Zinc Cobalt (RoHS)
- 416 = Electroless Nickel (RoHS)
- 608 = Black Anodised (RoHS)
- 714 = Olive Drab Chromate over Cadmium
- 771 = Black Zinc Cobalt
- 62ZN = Black Zinc Nickel (Replaces 62GB at front of part no.)
- 62GBCU = Brass (Replaces 62GB at front of part no.)
- 62GBSS = Stainless Steel (Replaces 62GB at front of part no.)

Lanyard length codes

- 1054 = No Lanyard
- 1057 = 3" lanyard length
- 1058 = 4" lanyard length
- 1059 = 5" lanyard length
- 1060 = 6" lanyard length
- 1062 = 8" lanyard length
- 1064 = 10" lanyard length

GASKET

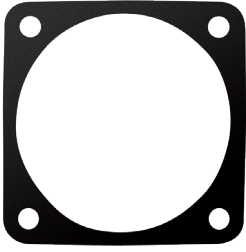

Material: Polychoroprene

Thickness: .029 (.74) +/-0.13 (.33)

SHELL SIZE	GASKET
8	62GB-760-08
10	62GB-760-10
12	62GB-760-12
14	62GB-760-14
16	62GB-760-16
18	62GB-760-18
20	62GB-760-20
22	62GB-760-22
24	62GB-760-24

SOLDER ASSEMBLY INSTRUCTIONS

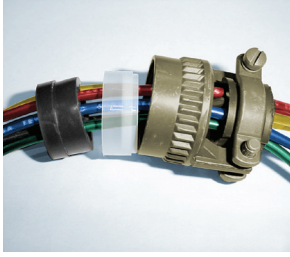

STEP 1: Slide the back-end accessories over the wire bundle in the proper sequence for reassembly: cable clamp and/or endbell first, then ferrule/follower and coupling nut (if used).

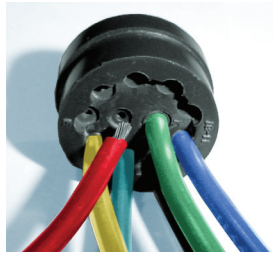

STEP 2: Pre-tin the wire ends and insert the individual wires through the proper holes in the grommet.

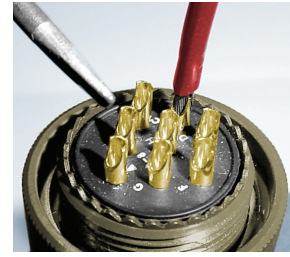

STEP 3: Solder the wires to the appropriate contacts on the rear of the connector.

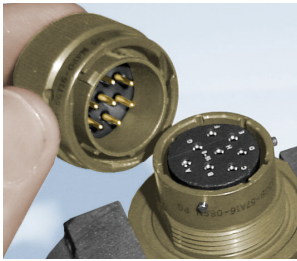

STEP 4: Place the connector in the fixture for reassembly using the endbell assembly tool or a mating connector with the contacts installed.

STEP 5: Slide the grommet down the wires – lubricating the grommet with isopropyl alcohol will help.

STEP 6: Fill each unused cavity in the grommet with a wire hole filler to maintain the sealing integrity of the connector.

Step 7: Slide ferrule and endbell accessories over the rear of the connector and tighten.

All dimensions in inches (millimeters in parenthesis)

CRIMP TOOL OPERATION NOTE: Hand-crimp tools can be used with size 20, 16 and 12 contacts.

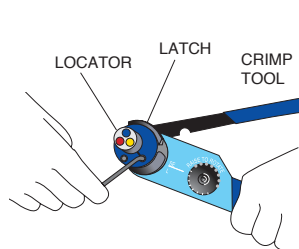

STEP 1: Strip the wires to the appropriate length. See strip lengths on the Contact Selection Guide, → page 162.

STEP 2: Open the crimp tool by squeezing the handles. Push the latch on the turret to release the locator. Attach the turret to the crimp tool using the two captive hex bolts in the turret.

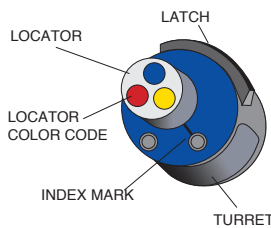

STEP 3: Select the proper locator position for your contact by rotating the locator until the proper color is aligned with the index mark. Push locator down until it snaps into position.

CONTACT SIZE	LOCATOR COLOR
20	Red
16	Blue
12	Yellow

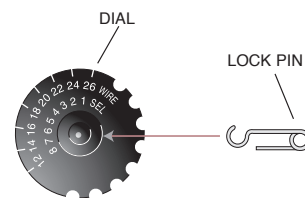

STEP 4: Adjust dial for proper wire gauge. To change the dial setting, remove the lock pin and lift center of dial. Turn to the desired wire gauge. Replace lock pin on dial.

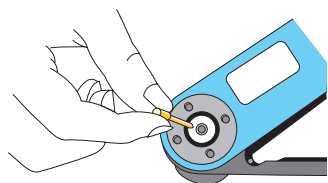

STEP 5: Cycle the tool before inserting the contact to be sure the tool is in the open position. Drop the contact, mating end first, into the crimp cavity of the tool. Squeeze the tool handle just enough to grip the contact without actually crimping it.

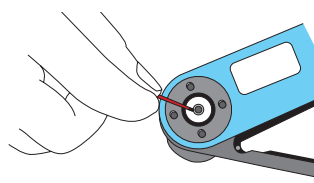

STEP 6: Insert the stripped wire into the contact with a slight twisting motion. Be sure all wire strands are inside the contact. Squeeze the handle to cycle the tool. The handle will not release until the contact is completely crimped.

STEP 7: Remove the crimped contact. Pull on the wire slightly to be sure it is properly crimped. Be sure the contact is not bent or damaged in any way. Visually inspect the crimp.

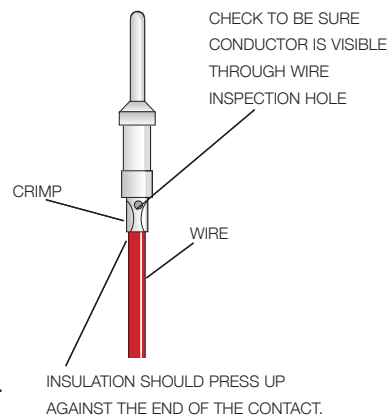

MICRO-SECTIONS : Enlargement of micro-section permits a final inspection of crimp quality. This test is recommended whenever new tools or new types of wire or contacts are used.

INSERTION OF CONTACTS

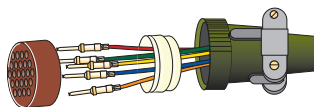

STEP 1: Slide the rear accessories over the wire bundle in the proper sequence for re-assembly: cable clamp and/or endbell first, then ferrule, and coupling nut.

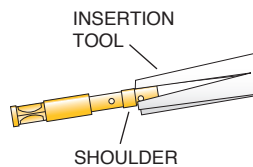

STEP 2: Use the proper insertion tool from the Contact Selection Chart on → page 162. Place the contact in the tool. The tool should press against the shoulder of the contact. Contact sizes 20, 16, and 12 use a pliers-style tool.

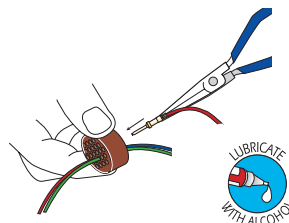

STEP 3: Lubricate the grommet with isopropyl alcohol (do not use any lubricant other than isopropyl alcohol). Insert the contact through the appropriate cavity in the grommet.

STEP 4: Place the connector into an assembly fixture (fixtures are available for production use, contact us for information.)

INSERTION OF CONTACTS (CONTINUED)



STEP 5: Lubricate the contact cavities of the connector insulator with isopropyl alcohol (do not use any other type of lubricant).

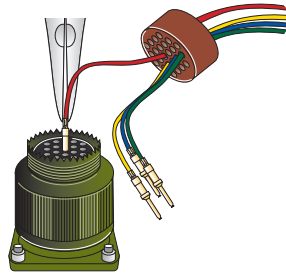

STEP 6: Using guide pins where necessary, push straight down with a firm, even pressure until the contact snaps into position in the proper cavity. Start at the center of the pattern and work toward the outer edges.

UNCRIMPED CONTACTS

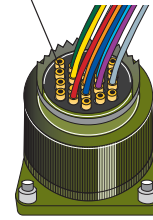

STEP 7: Fill any unused cavities with contacts.

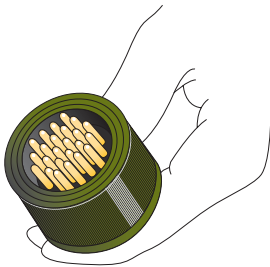

STEP 8: Check the mating face of the connector to ensure that all the same-sized contacts are on the same plane (fully inserted); If not, the contact is not fully inserted. Remove the contact using the proper extraction tool and procedure and reinsert. Do not attempt to reinsert the insertion tool to correct the problem.

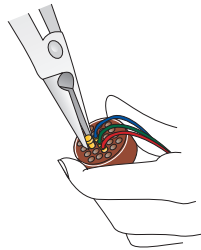

STEP 9: A wire hole filler must be inserted into the grommet behind the unused contacts to maintain the sealing integrity of the connector. See the Contact Selection Chart on [page 162](#) for wire hole fillers.

STEP 10: Place the connector back in the fixture for re-assembly. Slide the connector accessories down the cable over the rear of the connector and tighten. Use the appropriate endbell tools.

EXTRACTION OF CONTACTS

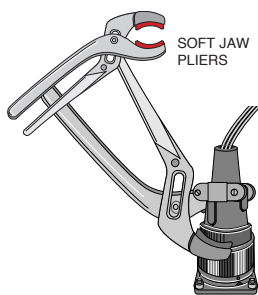

STEP 1: Remove the endbell accessories and slide them back over the wires. Use the appropriate endbell tools.

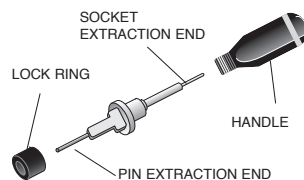

STEP 2: Use the proper extraction tool from the Contact Selection Chart on [page 162](#). The extraction tool can be used for both pin and socket contacts by removing the shaft from the handle and reversing it for pin or socket extraction.

CROSS-SECTION OF CONNECTOR

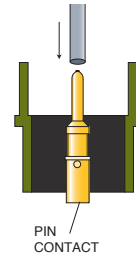

PIN CONTACT

CROSS-SECTION OF CONNECTOR



SOCKET CONTACT

STEP 3: On the mating face of the connector, insert the tool over the pin contact or into the socket contact until the tool reaches bottom. Apply a slow, continuous pressure to push the contact through the rear of the connector. When the shoulder of the tool hits against the insulator, the contact is extracted.

STEP 4: Carefully remove the extraction tool from the connector to avoid damage to the insulator.