

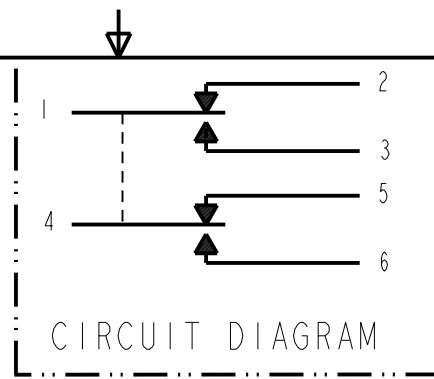



HONEYWELL PART NUMBER
622EN69-3
FAA-PMA 

REV	DOCUMENT	CHANGED BY	CHECK
16	0006861	AS 02AUG04	AK



NOTES

- 1 - CORROSION RESISTANT STEEL ENCLOSURE
- 2 - SWITCH SEALED PER MIL-PRF-8805 SYMBOL 4
- 3 - CATALOG LISTING, CIRCUIT DIAGRAM, FEG MFG CODE AND FAA-PMA ARE SHOWN ON NAMEPLATE
- 4 - COINCIDENCE OF OPERATING AND RELEASING POINTS: .010 OF PLUNGER TRAVEL
-  TO ADJUST ROLLER DIRECTION REMOVE ROLLER GUIDE LOCK RING, SCREW ROLLER GUIDE TO DESIRED DIRECTION, SECURE BY REPLACING ROLLER GUIDE LOCK RING
-  THE ROLLER GUIDE LOCATION COULD GO TO A MINIMUM OF .292 AND CAN BE ADJUST TO .450 MAX AND STILL MAINTAIN A .125 MIN OVERTRAVEL
-  HARDWARE MAY BE PACKAGED UNASSEMBLED PER MIL-PRF-8805
-  FOR MANUFACTURING DETAIL SEE ASSEMBLY DRAWING 622EN69-3 FOR FAA-PMA

6X NO. 20 WIRE LEAD PER MIL-W-22759/7 MARKED WITH CIRCUIT IDENTIFICATION AND WIRE GAGE (1-20, 2-20, ETC) PER MIL-W-5088

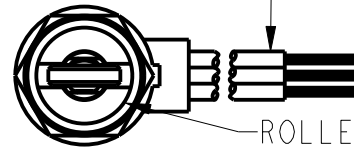

ROLLER GUIDE MAY BE LOCKED IN INCREMENTS OF 45° AZIMUTH. IT MAY ALSO BE UNSCREWED AND REMOVED FROM BUSHING TO FACILITATE INSTALLATION 

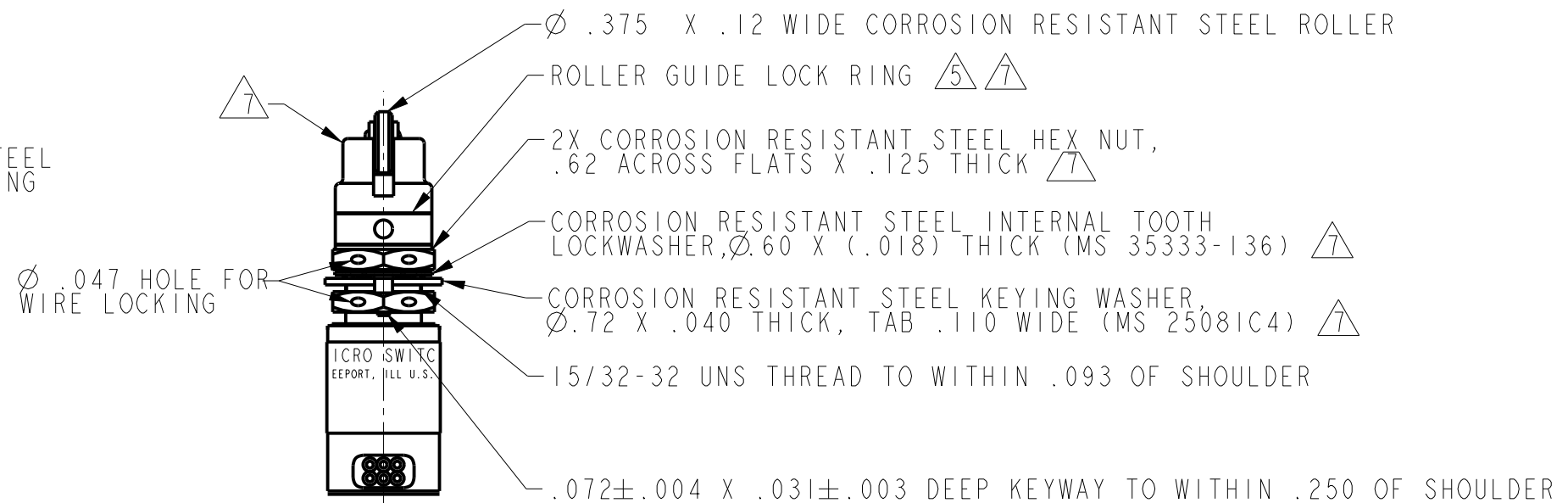
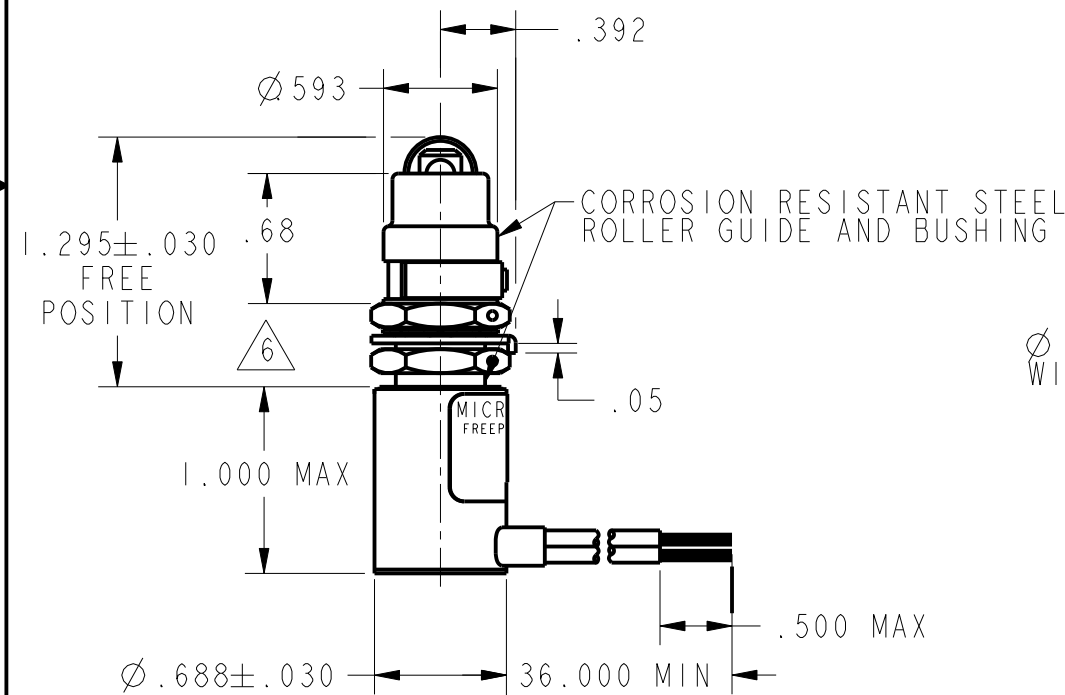

CHARACTERISTICS
OPERATING FORCE ----- 6-12 LB
FULL OVERTRAVEL FORCE-----30 LB MAX
RELEASE FORCE ----- 4 LB MIN
PRETRAVEL ----- .025 ± .015
DIFFERENTIAL TRAVEL----- .020 MAX
OVERTRAVEL----- .125 MIN
FREE POSITION

ELECTRICAL DATA		
CONTACT ARRANGEMENT 2X S P D T		
LOAD	SEA LEVEL	50,000 FT
	7	7
RES	4	2.5
IND	4	
MOTOR		

DESIGN UNITS: INCH
TOLERANCES UNLESS NOTED:
NO PLACE X ± 0.400
ONE PLACE .X ± 0.030
TWO PLACE .XX ± 0.015
THREE PLACE .XXX ± 0.005
FOUR PLACE .XXXX ± 0.0005
ANGLES X ± 3
THIRD ANGLE PROJECTION

DRAWN	JLH	01NOV00
CHECK	SAV	01NOV00
THIS DRAWING COVERS A PROPRIETARY ITEM AND IS THE PROPERTY OF HONEYWELL. THIS DRAWING IS NOT TO BE COPIED OR USED WITHOUT THE PERMISSION OF HONEYWELL.		
INTERPRET PER ASME Y14.5M-1994 OTHER HONEYWELL ENGINEERING STANDARDS MAY APPLY		
Pro/ENGINEER	2D	

Honeywell			
TITLE SWITCH-ENCLOSED			
SIZE	TYPE	DRAWING NAME	REV
B	I	622EN69-3	16
SCALE FULL	WEIGHT 5.5 OZ MAX	SHEET 1 OF 1	